

palbit[®]
TOOLING SOLUTIONS EXPERTS

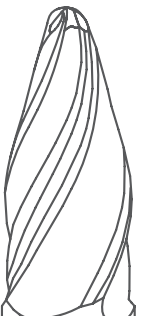

SINCE 1916

GENERAL CATALOGUE - METRIC

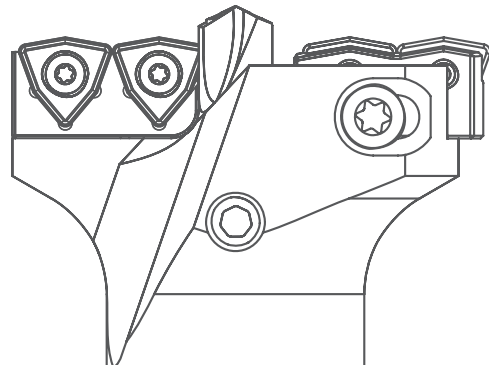
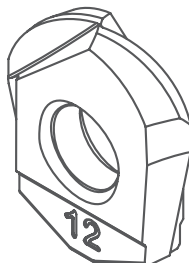
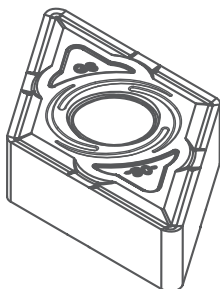
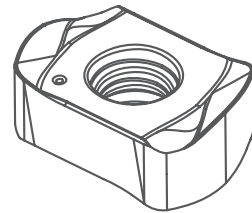
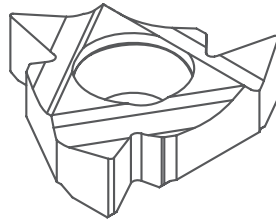
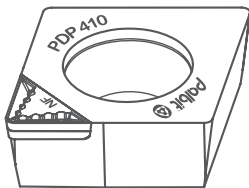
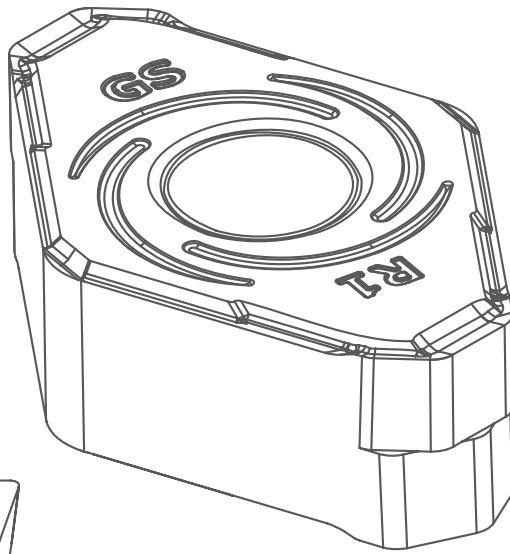
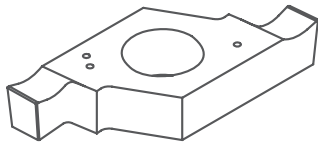
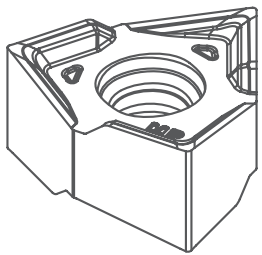



AEROSPACE &
DEFENSE



GENERAL
ENGINEERING



AUTOMOTIVE



MOULD & DIE



RAILWAY



SHIPBUILDING



WIND ENERGY



BAR PEELING



POWER
GENERATION

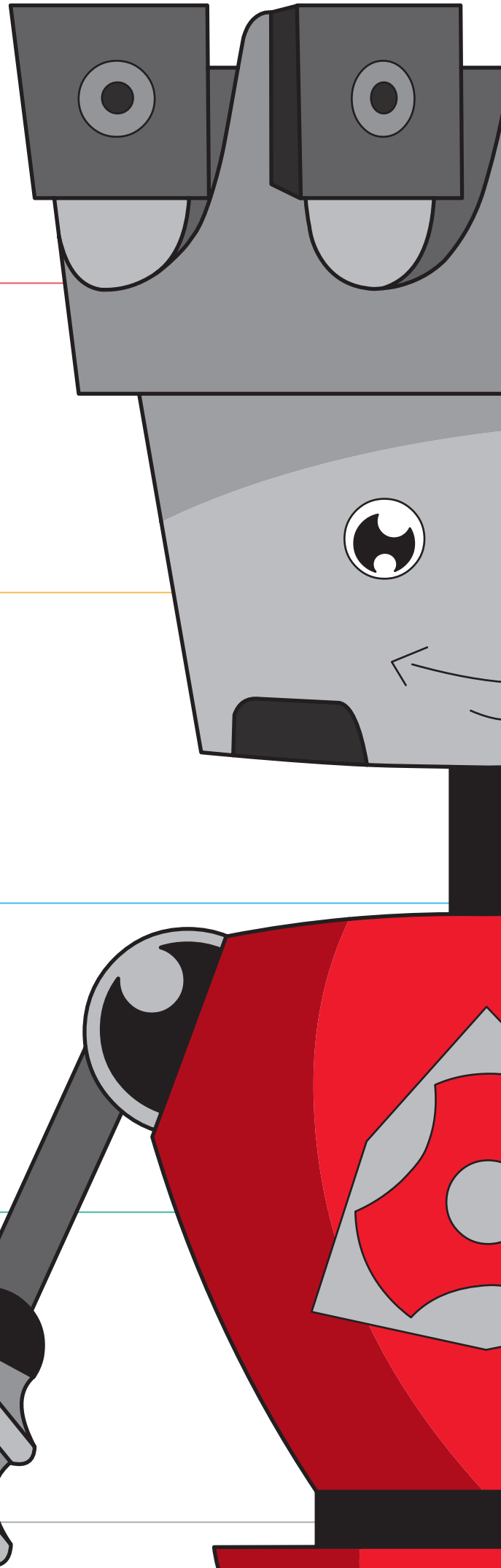

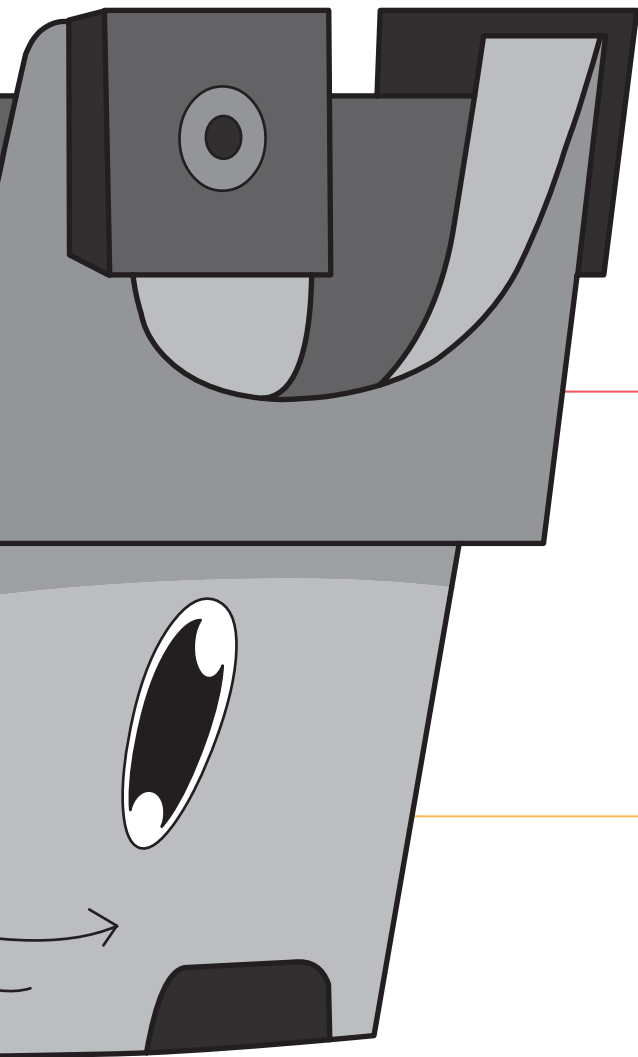

MILLING



DRILLING



TURNING



GROOVING &
PARTING OFF



THREADING

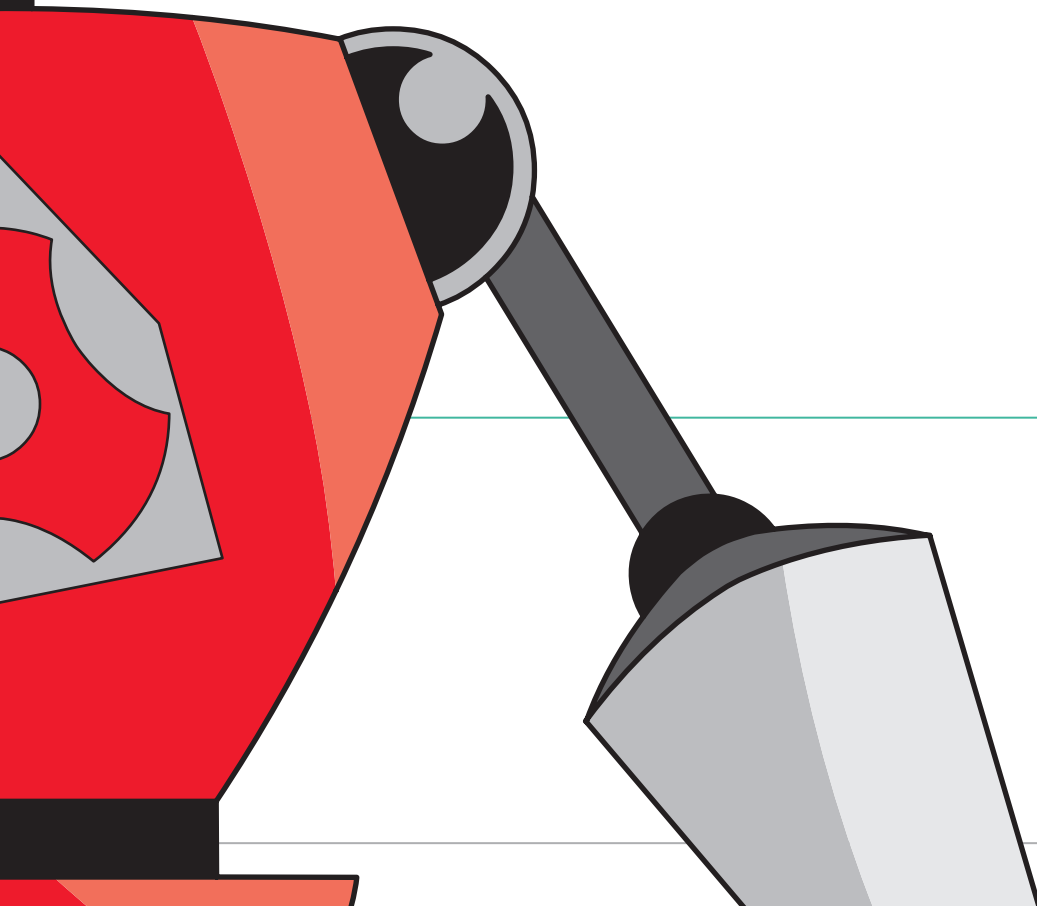

NEW MILLING GRADE = PHP | Novo revestimento - PHP | Nuevo recubrimiento - PHP

The pioneering coating technology!

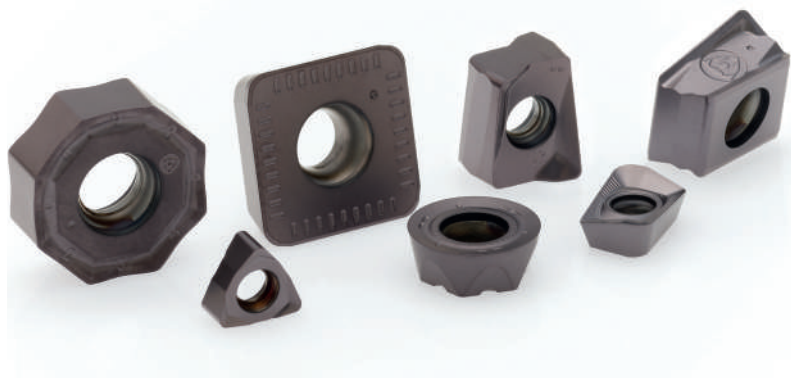

- PHP603
- PHP910
- PHP920
- PHP930
- PHP530



TETRAFEED 16320 | HEXAPLUS 49590

TETRAFEED 16320



HEXAPLUS 49590



XNKU 06T3...

XNKU-MP
PHP



XNKU-MP
PHH

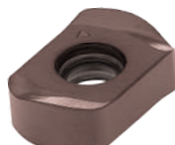

XNKU-MP
PHS

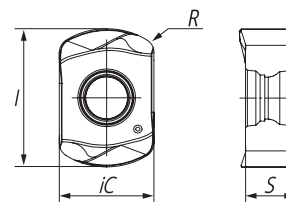
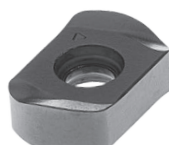

WCR 08... | WCL 08...



WCR



WCL

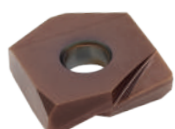

WCR

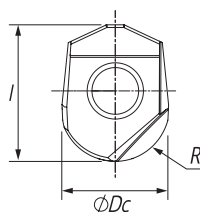

WCL

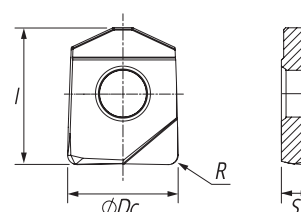

NEW MILLING GRADE = PHH || Novo revestimento - PHH | Nuevo recubrimiento - PHH

The revolution on coating technology!



- PHH603
- PHH910
- PHH920
- PHH930
- PHH530



TURBOMILL 34190 - 34290

TURBOMILL 34190



TURBOMILL 34290



W-PRO 62090

W-PRO 62090



BALLPRO 63090

BALLPRO 63090



RPHT 1605...

RPHT-LS
PHH



RPHT-LS
PHP

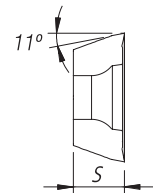
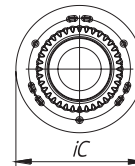

XPGT 3206...

XPGT



XPGT

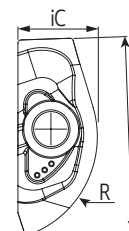

NEW TURNING GRADE = PHH || Novo revestimento - PHH | Nuevo recubrimiento - PHH

A new turn for Stainless Steel and HRSA Turning!



PHH910

PHH920

PHH
NEW
GRADE

Higher performance achieved by grinding machining technology



PBY603

PBY620

PCBN

Laser machining technology

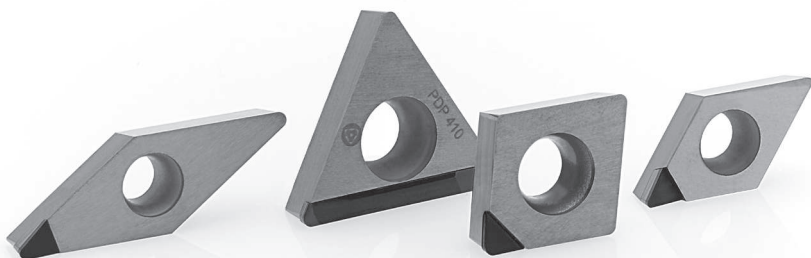

PDP410

PDP410

PCD

NEW GS CHIP-BREAKER | Quebra- aparos GS | Rompevirutas GS

Designed especially for HRSA, the new chip-breaker **GS** combined with the latest PHH technology, offers exceptional performance in the exotic materials machining.

- 🔗 First choice for **HRSA** medium to finishing turning;
- 🔗 Highly advanced cutting design;

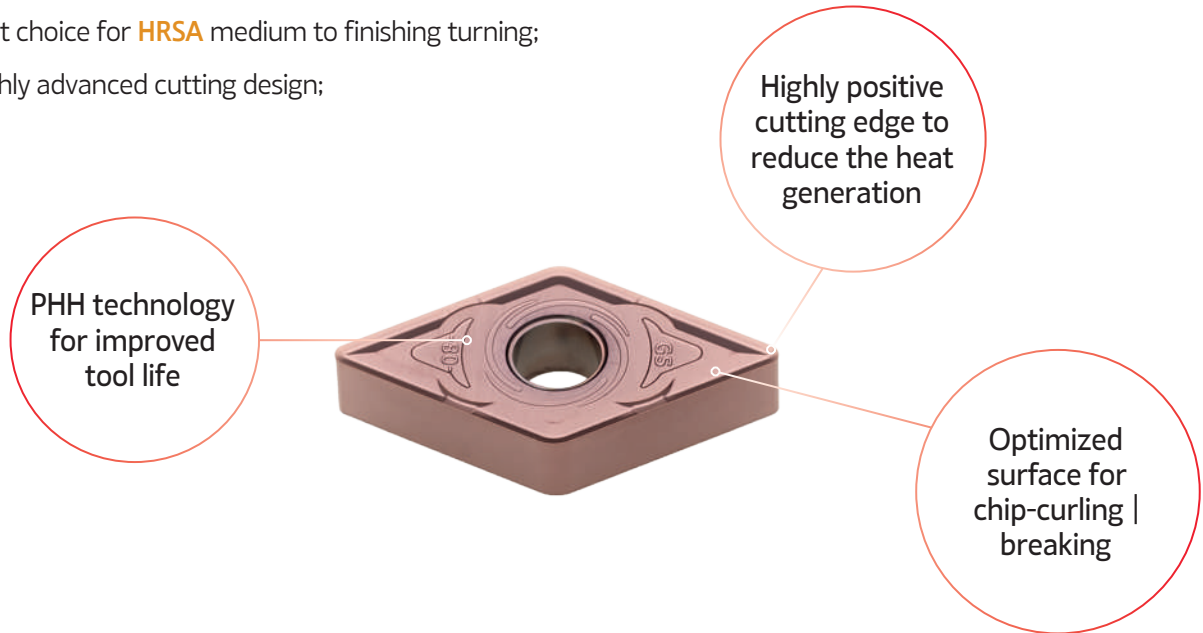

Another way of machining-rough to medium cut with **DOMX**[®]



GROOVING & PARTING OFF NEWS

NEW LIGHT GROOVING PROGRAM

LGX 06... | LG 06...

LGX-R

LG-L

LGX-R

LG-L

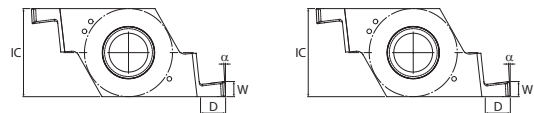
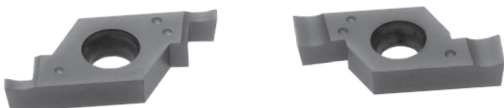



A

A - MILLING

A - 08 | Milling tool selection

A - 10 | Coupling types

A - 11 | Milling tools codification

A - 12 | Milling Tools Overview

A - 36 | New Grades



MILLING



A - 38 | Inserts Overview
A - 56 | FACE MILLING
A - 88 | HIFEED MILLING
A - 124 | SHOULDER MILLING
A - 196 | PROFILE MILLING
A - 228 | HARDMILL

A - 230 | CENTER & CHAMFER
A - 232 | SPOT FACE
A - 234 | Spare Parts
A - 240 | Technical Data
A - 256 | PCD TIPPED END MILLS
A - 262 | SOLID CARBIDE END MILLS

1 - Define your operation type:

- Face milling
- Highfeed milling
- Shoulder milling
- Profile milling
- Hardmill

Select your tool:

See page A - 18

MILLING TOOLS OVERVIEW

HPC ALUMINUM COATINGS					HPC ALUMINUM COATINGS				
Series	PLUS 2808H	PLUS 9026H	PLUS 9084H	PLUS 9094H	Series	PLUS 9124H	LINPRO 0864H	LINPRO 0964H	LINPRO 0054H
Image					Image				
Material	Al, Ti, In	Al, Ti, In	Al, Ti, In	Al, Ti, In	Material	Al, Ti, In	Al, Ti, In	Al, Ti, In	Al, Ti, In
Coating	AlN, TiN, TiAlN	AlN, TiN, TiAlN	AlN, TiN, TiAlN	AlN, TiN, TiAlN	Coating	AlN, TiN, TiAlN	AlN, TiN, TiAlN	AlN, TiN, TiAlN	AlN, TiN, TiAlN
Application	Aluminum	Aluminum	Aluminum	Aluminum	Application	Aluminum	Aluminum	Aluminum	Aluminum
Notes	For high speed cutting of aluminum	For high speed cutting of aluminum	For high speed cutting of aluminum	For high speed cutting of aluminum	Notes	For high speed cutting of aluminum	For high speed cutting of aluminum	For high speed cutting of aluminum	For high speed cutting of aluminum

2 - Define your material according to ISO:

- P** Steel
- M** Stainless Steel
- K** Cast Iron
- N** Aluminium & Non Ferrous Materials
- S** Heat Resistant and Titanium Alloy
- H** Hardened Material

See the chapter General Technical Data on the last pages for Palbit Selection Materials - PSM

WORKPIECE MATERIALS - PALBIT SELECTION MATERIALS, PSM

ISO Code	Material	Application	Notes	Image
Steel, Ferritic and Martensitic Stainless Steel				
P	1. C45	Medium to high speed cutting of steel	ISO 650	
P	2. 1.4303	High speed cutting of stainless steel	ISO 650	
P	3. 1.4571	High speed cutting of stainless steel	ISO 650	
Easy-cutting, Austenitic and Duplex Stainless Steel				
M	4. 1.4303	High speed cutting of stainless steel	ISO 650	
M	5. 1.4571	High speed cutting of stainless steel	ISO 650	
M	6. 1.4571	High speed cutting of stainless steel	ISO 650	
Cast Iron				
K	7. G1000	Medium to high speed cutting of cast iron	ISO 650	
K	8. G1500	High speed cutting of cast iron	ISO 650	
K	9. G1800	High speed cutting of cast iron	ISO 650	
Aluminium and Non-Ferrous				
N	10. 6061	High speed cutting of aluminum	ISO 650	
N	11. 7075	High speed cutting of aluminum	ISO 650	
Heat Resistant Super Alloys				
S	12. Inconel 718	High speed cutting of titanium alloy	ISO 650	

3 - Select your milling cutter.

Choose the cutter pitch and mounting:

- Use a close pitch cutter as first choice
- Use a coarse pitch cutter for long overhang and unstable conditions
- Choose a mounting type
- The cutter marked as “stock available under request” has a minimum order quantity according to the following table:

Qty	* ØDc Size
10	≤ 100 mm
5	> 100 mm

TETRAFEED 16320

Proprietary cutting tool

Arbor Mounting
K₁ 1071, T₁ 111, Per 1.4

Threaded Coupling
K₁ 1071, T₁ 111, Per 1.4

Series	Material	Application	Notes	Image
TETRAFEED 16320	Aluminum	High speed cutting of aluminum	ISO 650	
TETRAFEED 16320	Aluminum	High speed cutting of aluminum	ISO 650	
TETRAFEED 16320	Aluminum	High speed cutting of aluminum	ISO 650	
TETRAFEED 16320	Aluminum	High speed cutting of aluminum	ISO 650	
TETRAFEED 16320	Aluminum	High speed cutting of aluminum	ISO 650	
TETRAFEED 16320	Aluminum	High speed cutting of aluminum	ISO 650	
TETRAFEED 16320	Aluminum	High speed cutting of aluminum	ISO 650	
TETRAFEED 16320	Aluminum	High speed cutting of aluminum	ISO 650	
TETRAFEED 16320	Aluminum	High speed cutting of aluminum	ISO 650	
TETRAFEED 16320	Aluminum	High speed cutting of aluminum	ISO 650	

4 - Select your insert.

Choose the chip-breaker for your operation:

- Chip-breaker L= Light (for light cuts when low forces/power are required)
- Chip-breaker M = Medium (first choice for mixed production)
- Chip-breaker H = Heavy (for rough operations, forging, cast skin and vibration)
- Select insert grade for optimum productivity
- The insert marked as “stock available under request” has a minimum order quantity according to the following table:

Qty	*IC Size
300	≤ IC 25 mm
150	> IC 25 mm

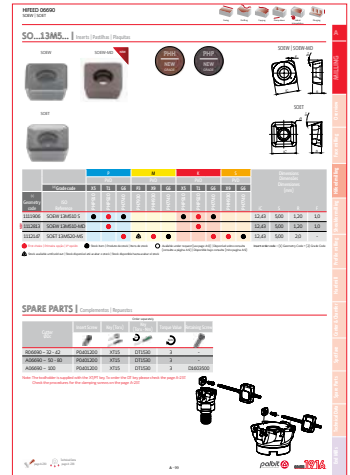

5 - Define your starting cutting parameters.

Cutting speeds and feeds for different materials are given on the insert boxes and in the tables for each solution.

The values should be optimized according to the machine and conditions.

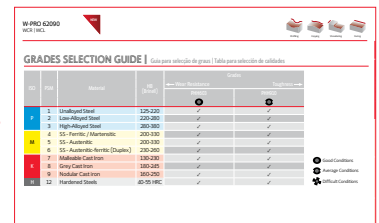

INSERTS CODIFICATION FOR MILLING HOLDERS

Codificação de pastilhas para fresas | Codificación de insertos para herramientas de fresado

Code	Inserts Description	Page	Code	Inserts Description	Page	Code	Inserts description	Page
000	PD...W 1204	82	202	XPET 1706	153	450	WNHU 060410	196
060	SE...T/W 1204	76	245	RDHW 0702	217	490	WNHU 04T3...	125 196
062	SP...X 1204	178	250	RD...T/W 1003 MO	217	495	WNXT 0806...	121
063	POKT 0403	89	251	RD...T/W 12T3MO	217	500	WNMW 1207	113
064	SOEW SOET 0803...	93	252	RD...T/W 1604MO	217	505	WDET WDMW 1204...	109
065	SPKT/W 08T308	117	253	RD...T/W 2006MO	217	620	WCL(R)...	191 192
066	SOEW SOET 13M...	99	280	SN...U 1206	57	630	XPGT 3206...	194
068	SOEW SOET 1605...	104	335	RD...0802	203	720	XNHW 1205...	229
083	VCGX 220530	176	336	RP...10T3	203	760	XDGX 15M5	169
099	SE...T/W 13T3	79	337	RP...1204	203	770	XDGX 22M7	173
163	XNKU 06T3	85	338	RP...1605	203	900	LNXT 0904	158
170	AP...T 1003	181	339	RP...2006	203	901	LNXT 1306	161
171	ANHX 1004	126	341	RPHT 10T3-LS(4)	205	902	PN...X 1105	61
175	ANHX 1204	132	342	RPHT 1204-LS(4)	205	903	LNXT 1506	165
180	AP... 1604	187	351	RN...1204	211	908	SN...X 1206 & ON...X 0505	65
181	ANHX 1607	135	400	XDHW 060210	223	909	SN...X 1206	69
200	XP... 0602	139	405	XDHW 10T310	223	912	SN...X 1606 & ON...X 0606	73
201	XP... 1003	147	410	XDHW 040110	223			

COUPLING TYPES

A Tipo de acoplamento | Tipo de acoplamiento

Symbol Símbolo Símblo	Coupling type Tipo de acoplamento Tipo de acoplamiento	Inserts fixation type Fixação de pastilhas Fijación de plaquitas	Standard Norma Norma
A	Arbor mounting Montagem tipo árvore Montaje tipo husillo	Insert screw Parafuso pastilha Tornillo de la plaquita	ISO 6462
B		Wedge Cunha Cuña	ISO 6462
C		Insert screw and washer, Screw clamp or clamp Parafuso para pastilha e anilha, parafuso e grampo ou grampo Tornillo de la plaquita y arandela, tornillo y brida o brida	ISO 6462
D		Washer Anilha Arandela	ISO 6462
E	Cylindrical shank Haste cilíndrica Mango recto	Any type Qualquer tipo Cualquier tipo	DIN 1835 - A
R	Threaded coupling Acoplamento roscado Acoplamiento tipo tornillo	Any type Qualquer tipo Cualquier tipo	Palbit internal standard Norma interna Palbit
W	Weldon shank Haste weldon tipo mango	Any type Qualquer tipo Cualquier tipo	DIN 1835 - B

ISO ARBOR MOUNTING TYPES | Estilos de montagem ISO tipo árvore | Estilos de montaje ISO tipo husillo

Arbor type A

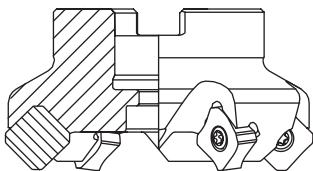

Arbor type B

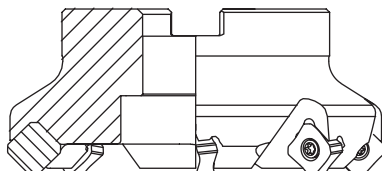

Arbor type C

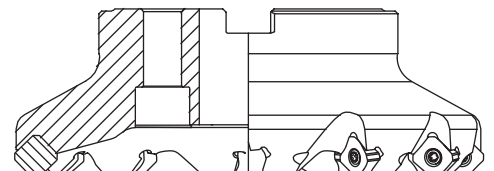

NOTE: For each type of arbor mounting (see previous table of coupling type on symbols A, B, C, D), we can have a different arbor types (see images above).

MILLING TOOLS CODIFICATION

Codificação das ferramentas de fresagem | Codificación de heramientas de fresado

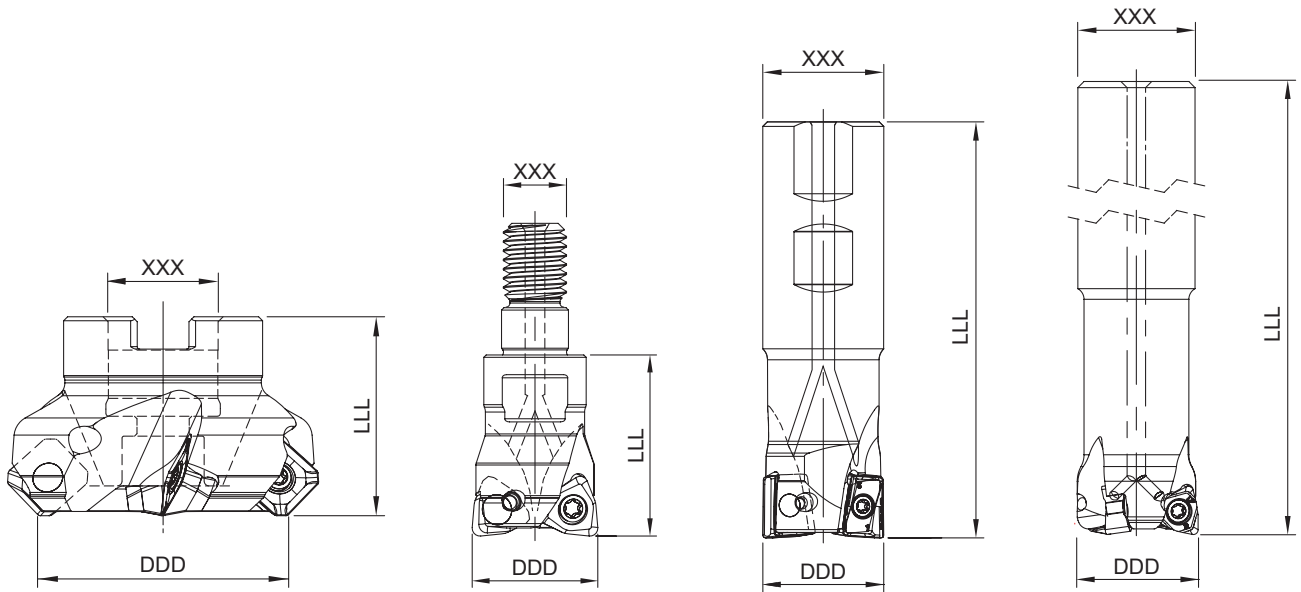

D D D Y Z Z Z T T - N N - L L U X X X L L L - L

Diameter
Diâmetro
Diámetro

Coupling Type (A-8)
Tipo de acoplamento (A-8)
Tipo de acoplamiento (A-8)

Insert Type (A-9)
Pastilha aplicável (A-9)
Inserto aplicable (A-9)

Lead angle
Ângulo de posicionamento da pastilha
Ángulo de posicion del inserto

Number of teeth
Número de dentes
Numero de dientes

Axial angle (angle of the tool construction)
Ângulo Axial (ângulo de construção da ferramenta)
Ángulo Axial (ángulo de la construcción de herramienta)

Cooling system
Refrigeração
Refrigeración
U - Without cooling system
U - Sem refrigeração
U - Sin refrigeración

Coupling diameter
Diâmetro de acoplamento
Diámetro de acoplamiento

Total length
Comprimento total
Longitud total

Rotation (R/L)
Rotação (R/L)
Rotación (R/L)
*In case of right rotation
the "R" is suppressed.

A

MILLING

Overview

Face milling

Hi-feed milling

Shoulder milling

Profile milling

Hardmill

Center & Chamfer







Spot face

Spare Parts

Technical Data

End Mills

MILLING TOOLS OVERVIEW

A	MILLING	LINEPRO	LINEPRO	LINEPRO ^{NEW}	P. HIFEED	HIFEED	HIFEED	HIFEED	HIFEED	ALUPRO	LINEPRO	TETRAFEED ^{NEW}	LINEPRO
		00036	06045	06290	06320	06410	06590	06690	06815	08390	09945	16320	17090
Overview	Page	82	76	178	88	92	116	98	104	176	78	84	180
Face milling	Insert	PD... 1204...	SE... 1204...	SP... 1204...	POKT 0403...	SO... 0803...	SP... 08T3...	SO... 13M5...	SO... 1605...	VCGX 2205...	SE... 13T3...	XNKU... 06...	AP... 1003...
Hifeed milling	Arbor mouting	Ø 66-160	Ø 50-160	Ø 40-160	Ø 40-66	-	-	Ø 50-100	Ø 63-160	-	Ø 50-250	Ø 40-63	Ø 40-63
Shoulder milling	Weldon Shank	-	-	-	-	Ø 20-32	Ø 20-32	-	-	-	-	Ø 16-32	Ø 16-25
Profile milling	Cylindrical Shank	-	-	-	Ø 20-40	-	-	-	-	-	-	-	-
Hardmill	Threaded Coupling	-	-	-	Ø 16-42	Ø 20-42	Ø 20-42	Ø 32-42	-	Ø 32	-	Ø 16-42	Ø 16-25
Center & Chamfer	 Facing												
Spot face	 Shouldering												
End Mills	 Slanted Shoulder & Chamfer												
Technical Data	 Ramp down												
Technical Data	 Helical Interpolation												
Technical Data	 Plunging												
Technical Data	 Side milling												
Technical Data	 Slotting												
Technical Data	 Profiling												
Technical Data	 Copying												
Technical Data	 Plunging & Recessing												

 Main Operation

 Other Operations

	PLUS 17190	PLUS 17590	LINEPRO 18090	PLUS 18190	LINEPRO 20090	LINEPRO 20190	LINEPRO 20290	TOROMILL 24590	TOROMILL 25090	TOROMILL 25190	TOROMILL 25290	TOROMILL 25390	PLUS 28088
	126	130	186	134	138	144	152	214	214	214	216	216	56
	ANHX 1004...	ANHX 1206...	AP... 1604...	ANHX 1607...	XPET 0602...	XPET 1003...	XPET 1706...	RD... 0702...	RD... 1003...	RD... 12T3...	RD... 1604...	RD... 2006..	SN...U 1206...
	Ø 40-100	Ø 40-125	Ø 40-125	Ø 50-160	-	Ø 40-63	Ø 40-125	-	Ø 42-52	Ø 50-80	Ø 52-160	Ø 80-160	Ø 50-200
	Ø 14-40	Ø 25-40	Ø 25-40	Ø 32-40	-	Ø 16-27	Ø 32-40	Ø 15	Ø 20	Ø 25	-	-	-
	-	Ø 26-33	-	-	Ø 10-21	-	-	-	-	-	-	-	-
	-	Ø 25-42	-	Ø 32-40	Ø 10-32	Ø 16-40	-	Ø 15-20	Ø 20-42	Ø 24-42	Ø 32-35	-	-
					 (only with XPET-HF)	 (only with XPET-HF)							

A

MILLING

Overview

Face milling

Hi-feed milling

Shoulder milling

Profile milling

Hardmill

Center & Chamfer

Spot face

Spare Parts

Technical Data

End Mills

MILLING TOOLS OVERVIEW

		TOROMILL 33590	TOROMILL 33690	TOROMILL 33890	TOROMILL 33990	TURBOMILL 34190 <small>NEW</small>	TURBOMILL 34290 <small>NEW</small>	TOROMILL X2 35190	LINEPRO 40095	LINEPRO 40595	LINEPRO 41095	PLUS 45095
MILLING	Page	200	200	202	202	204	204	210	222	222	222	198
	Insert	RDHT 0802...	RPHT 10T3...	RPHT 1605...	RPHT 2006...	RPHT 10T3...LS(4)	RPHT 1204...LS(4)	RNHX 1204...	XD... 0602...	XD... 10T3...	XD... 0401...	WNHU 0604...
Overview	Arbor mouting	-	-	Ø 50-125	Ø 80-125	Ø 42-52	Ø 40-80	Ø 40-80	-	Ø 52-80	-	-
	Weldon Shank	-	-	-	-	-	-	Ø 32	-	-	-	-
Face milling	Cylindrical Shank	Ø 16-25	Ø 20-32	-	-	-	-	-	-	-	-	-
	Threaded Coupling	Ø 16-32	Ø 20-35	-	-	-	-	Ø 32-42	Ø 16-25	Ø 25-42	Ø 10-12	Ø 25-42
Hifeed milling	 Facing											
Shoulder milling	 Shouldering											
Profile milling	 Slanted Shoulder & Chamfer											
	 Ramp down											
Hardmill	 Helical Interpolation											
Center & Chamfer	 Plunging											
	 Side milling											
Spotface	 Slotting											
Spare Parts	 Profiling											
Technical Data	 Copying											
	 Plunging & Recessing											

 Main Operation

 Other Operations

	PLUS 49090	PLUS 49095	NEW HEXAPLUS 49590	HIFEED 50060	HIFEED 50560	NEW W-PRO 62090	NEW BALLPRO 63090	HARDMILL 72090	ALUPRO 76090	ALUPRO 77090	TGPLUS 90090	TGPLUS 90190
	124	196	120	112	108	190	194	226	168	172	156	160
	WNHU 04T308-LP	WNHU 04T3...	WNXT 0806...	WN... 1207...	WD... 1204...	WC... 08...	XPXT 3206...	XNHW 1205...	XDGX 15M5...	XDGX 22M7...	LNXT 0904...	LNXT 1306...
	-	-	Ø 40-125	Ø 52-80	Ø 52-80	-	-	Ø 40-160	Ø 40-100	Ø 50-125	Ø 40-63	Ø 40-125
	-	-	Ø 32-50	-	-	-	-	-	-	-	Ø 16-32	Ø 25-40
	Ø 16-25	-	-	-	-	Ø 8-20	-	-	Ø 20-40	Ø 32-40	Ø 25-32	Ø 25-40
	Ø 16-32	Ø 16-35	-	Ø 35	-	-	Ø 32	-	-	-	Ø 25-32	-

A

MILLING

Overview

Face milling

Hifeed milling

Shoulder milling

Profile milling

Hardmill

Center & Chamfer

Spot face

Spare Parts

Technical Data

End Mills

MILLING TOOLS OVERVIEW

	PLUS 90260	TGPLUS 90390	PLUS 90845	PLUS 90945	PLUS 91245
Page	60	164	64	68	72
Insert	PN... 1105...	LNXT 1506...	SN... 1206... ON... 0505...	SN...1206...	SN... 1606... ON... 0606...
Arbor mouting	Ø 50-160	Ø 50-160	Ø 50-250	Ø 50-250	Ø 63-250
Weldon Shank	-	-	Ø 32-40	-	-
Cylindrical Shank	-	-	-	-	-
Threaded Coupling	-	-	-	-	-
 Facing					
 Shouldering					
 Slanted Shoulder & Chamfer					
 Ramp down					
 Helical Interpolation					
 Plunging					
 Side milling					
 Slotting					
 Profiling					
 Copying					
 Plunging & Recessing					

 Main Operation

 Other Operations

NEW W-PRO 62090 = NEW GRADE PHH

Nova linha W-PRO 62090 - Novo grau PHH | Nueva línea W-PRO 62090 - Nueva calidad PHH

The new W-PRO is the combination of the most refined inserts and the most stable shanks. When looking for a finishing solution for Steels, Stainless Steels, Cast Irons, HRSA or Hardened Steels that can work for a long time while delivering a flawless machined surface, this is the best solution.

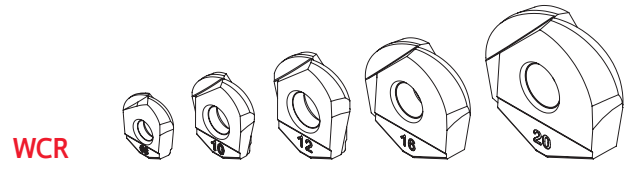
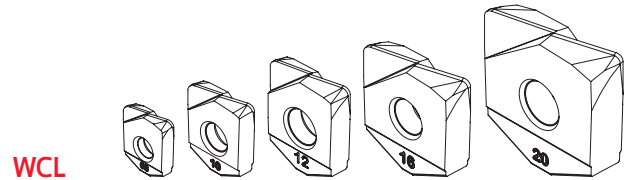

One toolholder for two types of inserts

PHH GRADE = PVD grade

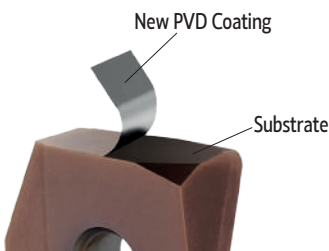

This new coating has a very high thermal stability and provides long tool life. For applications in machining of hardened steels, stainless steels and titanium alloys. This new coating achieves an unmatched balance between high hardness and thermal stability. It is the perfect coating for machining hardened material.

PHH603 NEW
 H05-H15
 P01-P05

Recommended for finishing operations in steels and hardened steels. First choice in mold and die finishing applications.









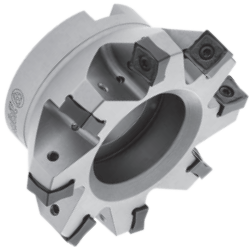

PHH910 NEW
 P05-P10
 H15-H30



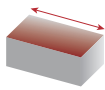
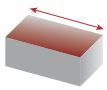
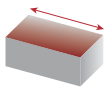
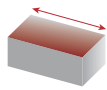
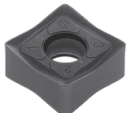

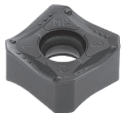



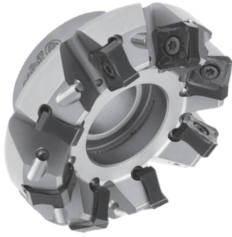

Recommended for finishing operations in steels and hardened steels in unstable conditions.

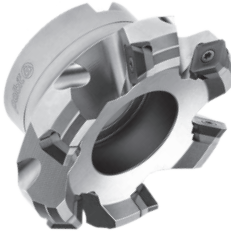
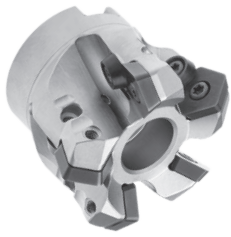
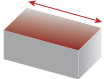
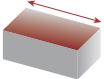
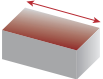
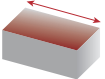
MILLING TOOLS OVERVIEW

A
 MILLING
 Overview
 Face milling
 Hifeed milling
 Shoulder milling
 Profile milling
 Hardmill
 Center & Chamfer
 Spot face
 Spare Parts
 Technical Data
 End Mills

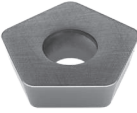

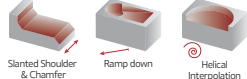

FACE MILLING CUTTERS





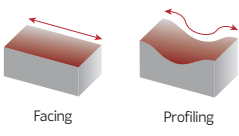
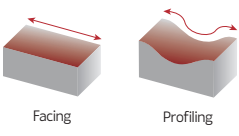
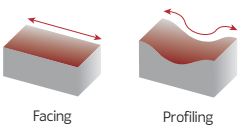
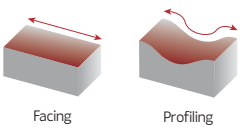

FACE MILLING CUTTERS				
Program	PLUS 28088	PLUS 90260	PLUS 90845	PLUS 90945
	Proprietary milling line	Proprietary milling line	Proprietary milling line	Proprietary milling line
				
Material	P M K	P K	P M K N S	P M K N S
Main Operation	 Facing	 Facing	 Facing	 Facing
Kr°	88°	60°	45°	45°
Range (ØDc - mm)	50 - 200	50 - 160	32 - 250	50 - 250
Insert	SN...1206... 	PN...1105... 	SN...1206... & ON...0505... 	SN...1206... 
Couplings	Arbor mounting	Arbor mounting	Arbor mounting Weldon shank	Arbor mounting
Other Operations	 Shouldering		 Slanted Shoulder & Chamfer	 Slanted Shoulder & Chamfer
Page	56	60	64	68
Features	Indexable face mills with 8 helical cutting edges For rough to semi-finish with high-efficiency face milling Cutting edge angle enables performing face milling very close to the sidewall	Economical because double sided inserts applied 10 coners available improved insert design for distribution of cutting forces Excellent solution for cast iron	New line for Heavy and Soft face milling Two different geometries for same pocket Insert geometries available for all applications materials Excellent surface finishing	Economical because double sided inserts applied Variety of insert geometries is available for all applications materials Excellent surface finishing Available in regular and fine pitch cutters

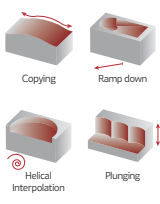
FACE MILLING CUTTERS				
Program	PLUS 91245	LINEPRO 06045	LINEPRO 09945	LINEPRO 00036
	Proprietary milling line 			
Material	P M K S	P M K N	P M K N	P K
Main Operation	 Facing	 Facing	 Facing	 Facing
Kr°	45°	45°	45°	36°
Range (ØDc - mm)	63 - 250	50 - 160	50 - 250	66 - 160
Insert	SN...1606... & ON...0606... 	SE...1204... 	SE...13T3... 	PD...1204... 
Couplings	Arbor mounting	Arbor mounting	Arbor mounting	Arbor mounting
Other Operations	 Slanted Shoulder & Chamfer	 Slanted Shoulder & Chamfer	 Slanted Shoulder & Chamfer	 Slanted Shoulder & Chamfer Ramp down Helical Interpolation
Page	72	76	78	82
Features	Two different geometries for same pocket Excellent surface finishing Available in regular and fine pitch cutters	Low cutting forces Good chip flow	Low cutting forces Suitable for high-speed machining Excellent chip flow High rigidity due to carbide shim	High rake angle and low cutting forces

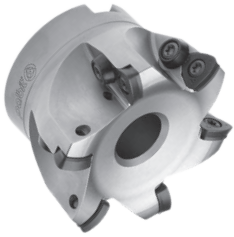
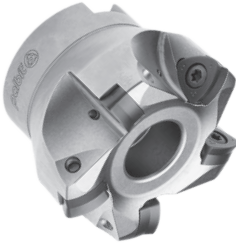
MILLING TOOLS OVERVIEW

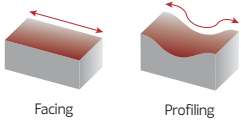
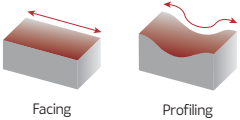
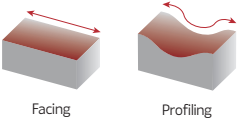
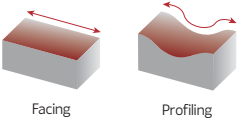



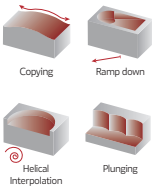
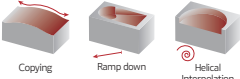
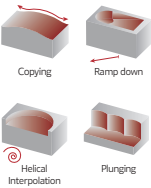
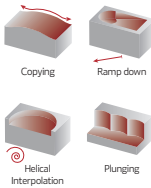





A
 MILLING
 Overview
 Face milling
 Hifeed milling
 Shoulder milling
 Profile milling
 Hardmill
 Center & Chamfer
 Spot face
 Spare Parts
 Technical Data
 End Mills



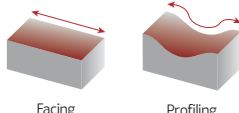
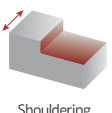
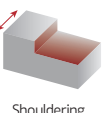
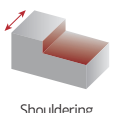
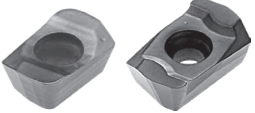

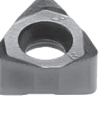

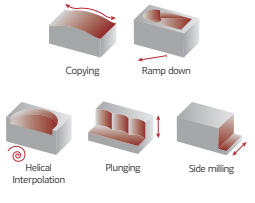
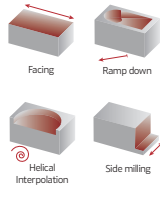

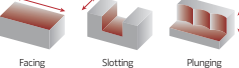
HIFEED MILLING CUTTERS				
Program	TETRAFEED 16320 <small>NEW</small>	PENTA HIFEED 06320	HIFEED 06410	HIFEED 06690
	Proprietary milling line 	Proprietary milling line 	Proprietary milling line 	Proprietary milling line 
Material	P M K S	P K	P M K S	P M K S
Main Operation	 Facing Profiling	 Facing Profiling	 Facing Profiling	 Facing Profiling
Kr°	20°	20°	10°	10°
Range (ØDc - mm)	16 - 63	20 - 66	20 - 42	32 - 100
	XN KU 06T3...	POKT 0403...	SO...0803...	SO...13M5...
Insert				
Couplings	Arbor mounting Weldon shank Threaded coupling	Arbor mounting Cylindrical shank Threaded coupling	Weldon shank Threaded coupling	Arbor mounting Threaded coupling
Other Operations	 Copying Ramp down Helical Interpolation Plunging	 Copying Ramp down Helical Interpolation Plunging	 Copying Ramp down Helical Interpolation Plunging	 Copying Ramp down Helical Interpolation Plunging
Page	84	88	92	98
Features	Double-sided insert with 4 cutting edges Optimized design for better chip evacuation High productivity	High feed cutting with low cutting load High productivity	High feed cutting with low cutting load High productivity	

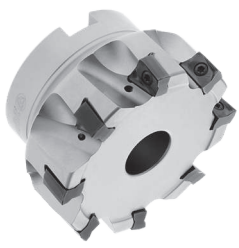
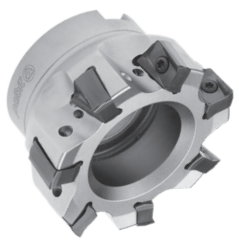
HIFEED MILLING CUTTERS				
Program	HIFEED 06815	HIFEED 50560	HIFEED 50060	HIFEED 06590
	Proprietary milling line 			
Material	P M K S	P M K S	P K	P M K
Main Operation	 Facing Profiling	 Facing Profiling	 Facing Profiling	 Facing Profiling
Kr°	15°	-	-	10°
Range	63 - 160	52 - 80	35 - 80	20 - 42
Insert	SO...1605...	WD...1204...	WN...1207...	SP...08T3...
				
Couplings	Arbor mounting	Arbor mounting	Arbor mounting Threaded coupling	Weldon shank Threaded coupling
Other Operations				
Page	104	108	112	116
Features	High feed cutting with low cutting load High productivity	High feed cutting with low cutting load	High feed cutting with low cutting load Excellent in high overhang	High feed cutting with low cutting load

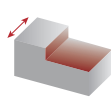
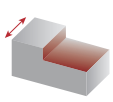
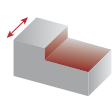
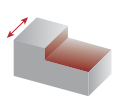
MILLING TOOLS OVERVIEW

A
 MILLING
 Overview
 Face milling
 Hifeed milling
 Shoulder milling
 Profile milling
 Hardmill
 Center & Chamfer
 Spot face
 Spare Parts
 Technical Data
 End Mills

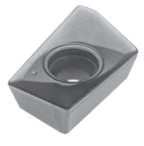
	HIFFED MILLING CUTTERS	SHOULDER MILLING CUTTERS		
Program	PRO 20090 20190	HEXAPLUS 96590 ^{NEW}	PLUS 49090	PLUS 17190
	Proprietary milling line 	Proprietary milling line 	Proprietary milling line 	Proprietary milling line 
Material	P M K S	P K	P K	P M K N S
Main Operation	 Facing Profiling	 Shouldering	 Shouldering	 Shouldering
Kr°	90°	90°	90°	90°
Range (ØDc - mm)	10 - 63	32 - 125	16 - 32	14 - 100
	XPET 0602... - HF XPET 1003... - HF	WNXT 0806...	WNHU 04T308-LP	ANHX 1004...
Insert				
Couplings	Arbor mounting Cylindrical shank Threaded coupling	Arbor mounting Weldon shank	Cylindrical shank Threaded coupling	Arbor mounting Weldon shank
Other Operations				
Page	138 144	120	124	126
Features	Chipbreaker HF for Hifeed machining	6 High rake cutting edges Excellent surface finish Strong insert seat	Economical because double sided inserts applied	4 corners insert with positive cutting edge Variety of insert geometries is available for all applications Helical cutting edge Available in regular and fine pitch cutters

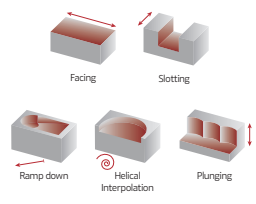
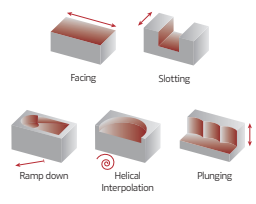
SHOULDER MILLING CUTTERS				
Program	PLUS 17590	PLUS 18190	LINEPRO 20090	LINEPRO 20190
	Proprietary milling line	Proprietary milling line	Proprietary milling line	Proprietary milling line
				
Material	P M K S	P K N	P M K N S H	P M K N S H
Main Operation	 Shouldering	 Shouldering	 Shouldering	 Shouldering
Kr°	90°	90°	90°	90°
Range (ØDc - mm)	25 - 125	32 - 160	10 - 32	16 - 63
	ANHX 1206...	ANHX 1607...	XP..0602...	XP...1003...
Insert				
Couplings	Arbor mounting Weldon shank Cylindrical shank Threaded coupling	Arbor mounting Weldon shank Threaded coupling	Cylindrical shank Threaded coupling	Arbor mounting Weldon shank Threaded coupling
Other Operations	 Facing Slotting Plunging	 Facing Slotting Plunging	 Facing Slotting Ramp down Helical Interpolation Plunging	 Facing Slotting Ramp down Helical Interpolation Plunging
Page	130	134	138	144
Features	4 corners insert with positive cutting edge Variety of insert geometries is available for all applications Helical cutting edge Available in regular and fine pitch cutters	4 corners insert with positive cutting edge Variety of insert geometries is available for all applications Helical cutting edge Available in regular and fine pitch cutters	Excellent solution for square shoulder milling Offers longer tool life, better tolerances and better productivity parameters Low power requirement & smooth cutting possible due to positive helical angle Very flexible and suitable for most milling operations High positive cutting rake geometry	

A

MILLING

Overview

Face milling

Hifeed milling

Shoulder milling

Profile milling

Hardmill

Center & Chamfer

Spot face

Spare Parts







Technical Data



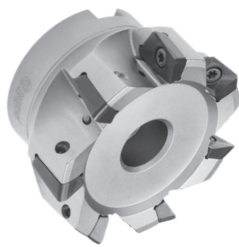

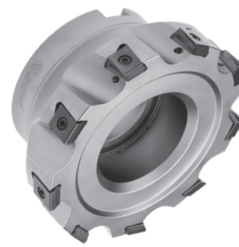
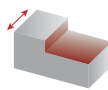
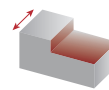
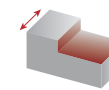
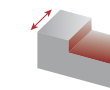

End Mills

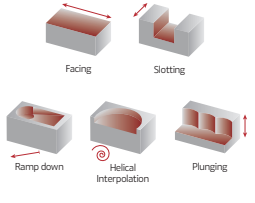
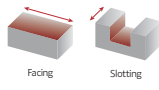
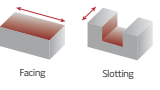
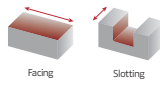
MILLING TOOLS OVERVIEW

A
 MILLING
 Overview
 Face milling
 Hi-feed milling
 Shoulder milling
 Profile milling
 Hardmill
 Center & Chamfer
 Spot face
 Spare Parts
 Technical Data
 End Mills

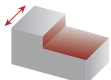
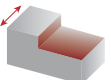
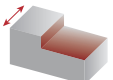

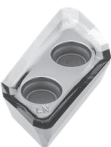
SHOULDER MILLING CUTTERS

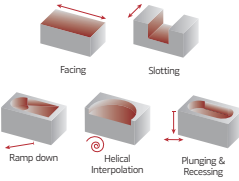
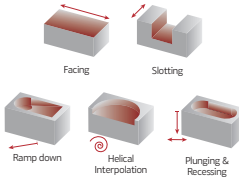
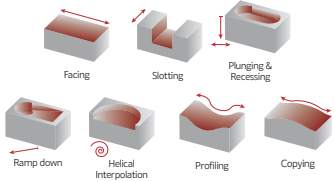

Program	LINEPRO 20290	TGPLUS 90090	TGPLUS 90190	TGPLUS 90390
	Proprietary milling line	Proprietary milling line	Proprietary milling line	Proprietary milling line
				
Material	P M K N S	P M K	P M K	P K
Main Operation	 Shouldering	 Shouldering	 Shouldering	 Shouldering
Kr°	90°	90°	90°	90°
Range (ØDc - mm)	32 - 125	16 - 63	25 - 125	50 - 160
	XP...1706...	LNXT 0904...	LNXT 1306...	LNXT 1506...
Insert				
Couplings	Arbor mounting Weldon shank	Arbor mounting Weldon shank Cylindrical shank Threaded coupling	Arbor mounting Cylindrical shank Weldon shank	Arbor mounting
Other Operations				
Page	152	156	160	164
Features	<p>Excellent solution for square shoulder milling</p> <p>Offers longer tool life, better tolerances and better productivity parameters</p> <p>Low power requirement & smooth cutting possible due to positive helical angle</p>	<p>Tangential inserts with 4 corners available</p> <p>High rake angle insert reduces cutting force</p> <p>Excellent insert rigidity and excellent machining stability</p> <p>Improved pocket configuration</p> <p>Available in regular and fine pitch cutters</p>		

SHOULDER MILLING CUTTERS			
Program	ALUPRO 76090	ALUPRO 77090	ALUPRO 08390
	Proprietary milling line	Proprietary milling line	
			
Material	N	N	N
Main Operation	 Shouldering	 Shouldering	 Shouldering
Kr°	90°	90°	90°
Range (ØDc - mm)	20 - 100	32 - 125	32
Insert	XDGX 15M5...	XDGX 22M7...	VCGX 2205...
			
Couplings	Arbor mounting Cylindrical shank	Arbor mounting Cylindrical shank	Threaded coupling
Other Operations			
Page	168	172	176
Features	Solution for multi functional milling operations on aluminium alloys High speed conditions with high metal remove rate Stable clamping conditions (Anti-fly) High rake angle geometry that provides a good surface finish and low cutting forces		Excellent chip flow

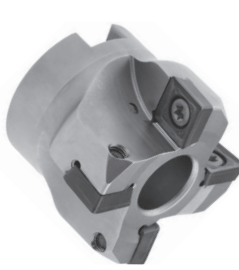
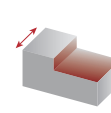
MILLING TOOLS OVERVIEW

- A
- MILLING
- Overview
- Face milling
- Hi-feed milling
- Shoulder milling
- Profile milling
- Hardmill
- Center & Chamfer
- Spot face
- Spare Parts
- Technical Data
- End Mills

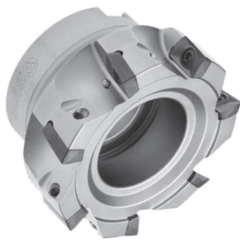
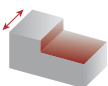
SHOULDER MILLING CUTTERS	
Program	LINEPRO 06290 NEW
	
Material	P M K S
Main Operation	 Shouldering
Kr°	90°
Range (ØDc - mm)	40 - 160
	SP...1204...
Insert	
Couplings	Arbor mounting
Other Operations	 Facing
Page	178
Features	Positive inserts with 4 cutting edges Recommended for conventional milling machines and machining centers

SHOULDER MILLING CUTTERS		
Program	LINEPRO 17090	LINEPRO 18090
		
Material	P M K N	P M K N
Main Operation	 Shouldering	 Shouldering
Kr°	90°	90°
Range (ØDc - mm)	16 - 63	25 - 125
Insert	AP...1003...	AP...1604...
		
Couplings	Arbor mounting Weldon shank Threaded coupling	Arbor mounting Weldon shank
Other Operations	 Facing Slotting Ramp down Helical Interpolation	 Facing Slotting Ramp down Helical Interpolation
Page	180	186
Features	<p>Strong insert and low cutting force</p> <p>Helical cutting edge</p> <p>Good chip evacuation</p>	

A

MILLING

Overview

Face milling

Hi-feed milling

Shoulder milling

Profile milling

Hardmill

Center & Chamfer

Spot face











Spare Parts

Technical Data

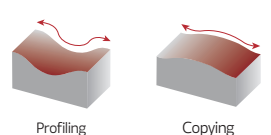
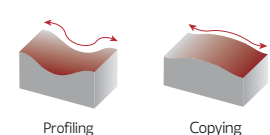
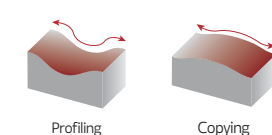
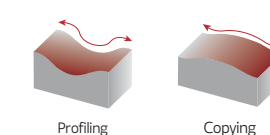
End Mills

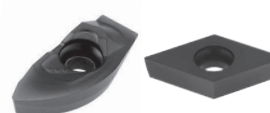
MILLING TOOLS OVERVIEW

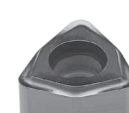
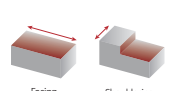
- A
- MILLING
- Overview
- Face milling
- Hifeed milling
- Shoulder milling
- Profile milling
- Hardmill
- Center & Chamfer
- Spot face
- Spare Parts
- Technical Data
- End Mills

PROFILE MILLING CUTTERS						
Program	NEW	W-PRO 62090	NEW	BALLPRO 63090	PLUS 49095	PLUS 45095
		Proprietary milling line		Proprietary milling line	Proprietary milling line	Proprietary milling line
						
Material		P M K S H		P K	P K H	P K H
Main Operation						
Kr°		90°		-	95°	95°
Range (ØDc - mm)		8 - 20		32	16 - 35	25 - 42
		WCL... WCR...		XPGT 3206... DCMW 11T3...	WNHU 04T3...	WNHU 0604...
Insert						
Couplings		Cylindrical shank Threaded coupling		Threaded coupling	Threaded coupling	Threaded coupling
Other Operations				-		
Page		190		194	124	198
Features		Helical profile for smooth cutting Tight Insert tolerances Carbide shank to reduce vibrations		Designed for finishing and semi-finishing Strong insert design Stable cutting performance	Economical because double sided inserts applied Designed for finishing and profile milling Robust geometry	

PROFILE MILLING CUTTERS				
Program	TOROMILL 33590	TOROMILL 33690	TOROMILL 33790	TOROMILL 33890
	Proprietary milling line 	Proprietary milling line 	Proprietary milling line 	Proprietary milling line 
Material	P M S	P M S	P M S	P M S
Main Operation	 Profiling Copying	 Profiling Copying	 Profiling Copying	 Profiling Copying
Kr°	-	-	-	-
Range (ØDc - mm)	16 - 32	20 - 52	40 - 80	50 - 125
Insert	RDHT 0802... 	RPHT 10T3... 	RPHT 1204... 	RPHT 1605... 
Couplings	Cylindrical shank Threaded coupling	Arbor mounting Cylindrical shank Threaded coupling	Arbor mounting	Arbor mounting
Other Operations	 Facing Slotting Ramp down Helical Interpolation	 Facing Slotting Ramp down Helical Interpolation	 Facing Slotting Ramp down Helical Interpolation	 Facing Slotting Ramp down Helical Interpolation
Page	200	200	200	202
Features	<p>Excellent solution for Profile milling</p> <p>Low power requirement & smooth cutting possible due to positive helical angle</p> <p>First choice for problematic materials (M and S material classes)</p> <p>High positive cutting rake geometry</p>			

MILLING TOOLS OVERVIEW

A
 MILLING
 Overview
 Face milling
 Hi-feed milling
 Shoulder milling
 Profile milling
 Hardmill
 Center & Chamfer
 Spot face
 Spare Parts
 Technical Data
 End Mills



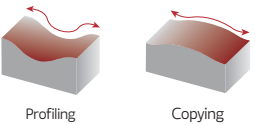
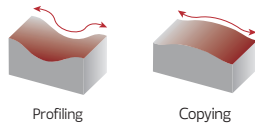
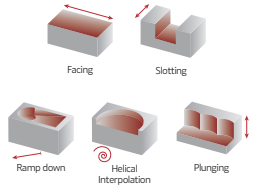











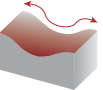
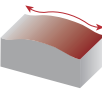
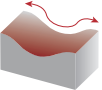
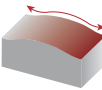
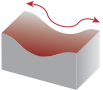
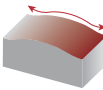
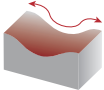
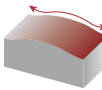
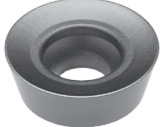

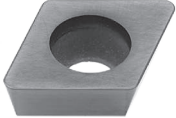







PROFILE MILLING CUTTERS				
Program	TOROMILL 33990	TURBOMILL 34190 <small>NEW</small>	TURBOMILL 34290 <small>NEW</small>	TOROMILL X2 35190
	Proprietary milling line 	Proprietary milling line 	Proprietary milling line 	Proprietary milling line 
Material	P M S	P M S	P M S	P M K S
Main Operation	 Profiling Copying	 Profiling Copying	 Profiling Copying	 Profiling Copying
Kr°	-	-	-	-
Range (ØDc - mm)	80 - 125	42 - 52	40 - 80	32 - 80
Insert	RPHT 2066... 	RPHT 10T3...-LS(4) 	RPHT 1204...-LS(4) 	RNHX 1204... 
Couplings	Arbor mounting	Arbor mounting	Arbor mounting	Arbor mounting Weldon shank Threaded coupling
Other Operations	 Facing Slotting Ramp down Helical Interpolation	 Facing Slotting Ramp down Helical Interpolation	 Facing Slotting Ramp down Helical Interpolation	 Facing Slotting Ramp down Helical Interpolation
Page	202	204	204	210
Features	Excellent solution for Profile milling Low power requirement & smooth cutting possible due to positive helical angle First choice for problematic materials (M and S material classes) High positive cutting rake geometry	Excellent solution for Profile milling First choice for problematic materials (M and S material classes) Improved insert seat	Excellent solution for Profile milling First choice for problematic materials (M and S material classes) Improved insert seat	Excellent solution for Profile milling "First choice for problematic materials (M and S material classes) High positive cutting rake geometry





PROFILE MILLING CUTTERS				
Program	TOROMILL 24590	TOROMILL 25090	TOROMILL 25190	TOROMILL 25290
				
Material	P K H	P K H	P K H	P K H
Main Operation	 <p>Profiling Copying</p>	 <p>Profiling Copying</p>	 <p>Profiling Copying</p>	 <p>Profiling Copying</p>
Kr°	-	-	-	-
Range (ØDc - mm)	15 - 20	20 - 52	24 - 80	32 - 160
Insert	RD...0702...	RD...1003...	RD...12T3...	RD...1604...
				
Couplings	Weldon shank Threaded coupling	Arbor mounting Weldon shank Threaded coupling	Arbor mounting Weldon shank Threaded coupling	Arbor mounting Threaded coupling
Other Operations	 <p>Facing Slotting Ramp down Helical Interpolation Plunging</p>	 <p>Facing Slotting Ramp down Helical Interpolation Plunging</p>	 <p>Facing Slotting Ramp down Helical Interpolation Plunging</p>	 <p>Facing Slotting Ramp down Helical Interpolation Plunging</p>
Page	214	214	214	216
Features	<p>Offers longer tool life, better tolerances and better productivity parameters</p> <p>Low power requirement & smooth cutting possible due to positive helical angle</p> <p>Very flexible and suitable for most milling operations</p> <p>High positive cutting rake geometry</p>			

MILLING TOOLS OVERVIEW

A
 MILLING
 Overview
 Face milling
 Hifeed milling
 Shoulder milling
 Profile milling
 Hardmill
 Center & Chamfer
 Spot face
 Spare Parts
 Technical Data
 End Mills

PROFILE MILLING CUTTERS

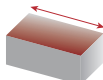
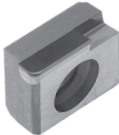
Program	TOROMILL 25390	LINEPRO 40095	LINEPRO 40595	LINEPRO 41095
				
Material	P K H	P K N H	P K N H	P K N H
Main Operation	 Profiling  Copying	 Profiling  Copying	 Profiling  Copying	 Profiling  Copying
Kr°	-	95°	95°	95°
Range (ØDc - mm)	80 - 160	16 - 25	25 - 80	10 - 12
	RD...2006...	XD...0602...	XD...10T3...	XD...0401...
Insert				
Couplings	Arbor mounting	Threaded coupling	Arbor mounting Threaded coupling	Threaded coupling
Other Operations	 Facing  Slotting  Ramp down  Helical Interpolation  Plunging	 Facing  Slotting  Ramp down  Helical Interpolation	 Facing  Slotting  Ramp down  Helical Interpolation	 Facing  Slotting  Ramp down  Helical Interpolation
Page	216	222	222	222
Features	<p>Offers longer tool life, better tolerances and better productivity parameters</p> <p>Low power requirement & smooth cutting possible due to positive helical angle</p> <p>Very flexible and suitable for most milling operations</p> <p>High positive cutting rake geometry</p>	<p>Designed for finishing and profile milling</p> <p>Low power consumption</p>		

	HARDMILL	CENTER & CHAMFER	SPOT FACE
Program	HARDMILL 72090	CENTER & CHAMFER	SPOT FACE
			
Material	K N	P M K	P M K
	 Facing		
	90°		
Range (ØDc - mm)	40 - 160	13	10 - 21
	XNHW 1205...	SOMT SOGT 11T3...	SPKX 05... 06... 07... 09...
Insert			
Couplings	Arbor mounting	Weldon Shank	Weldon Shank Cylindrical shank
	 Shouldering	Spotting Chamfering Engraving Grooving Spot Drilling	Spot face
Page	226	230	232
Features	Excellent solution for aluminium PCD tip	Milling tool for a wide range of center & chamfer operations	Economical solution Smooth cutting

A

MILLING

Overview

Face milling

Hi-feed milling

Shoulder milling

Profile milling

Hardmill

Center & Chamfer

Spot face

Spare Parts

Technical Data

End Mills

MILLING INSERTS ISO IDENTIFICATION SYSTEM

A

MILLING

Overview

Face milling

Hi-feed milling

Shoulder milling

Profile milling

Hardmill

Center & Chamfer

Spot face

Spare Parts

Technical Data

End Mills

H		M	
O		V	
P		W	
S		L	
T		A	
C		B	
D		K	
E		R	
F		X	Special

1- Insert shape symbol

Symbol	m (mm)	d (mm)	s (mm)
A	±0.005	±0.025	±0.025
F	±0.005	±0.013	±0.025
C	±0.013	±0.025	±0.025
H	±0.013	±0.013	±0.025
E	±0.025	±0.025	±0.025
G	±0.025	±0.025	±0.13
J	±0.005	±0.05~±0.13	±0.025
K*	±0.013	±0.05~±0.13	±0.025
L*	±0.025	±0.05~±0.13	±0.025
M*	±0.08~±0.20	±0.05~±0.13	±0.13
N*	±0.08~±0.20	±0.05~±0.13	±0.025
U*	±0.13~±0.38	±0.08~±0.25	±0.13

*As a rule, the sides of these inserts are as sintered. Tolerance differs with insert size, for the accuracy of class M, refer to the table on the right.

Triangular inserts with a facet (secondary cutting edge)

Detailed dimension of M class insert Insert height Tolerances (mm)					
Inscribed circle	T	S	C	D	V
6.35	±0.08	-	-	-	-
9.525	±0.08	±0.08	±0.11	±0.10	±0.13
12.70	±0.13	±0.13	±0.13	±0.15	-
15.875	±0.15	±0.15	±0.15	±0.18	-
19.05	±0.15	±0.15	±0.15	±0.18	-
25.40	-	±0.18	-	-	-
31.75	-	±0.25	-	-	-

Inscribed circle Tolerances (mm)					
Inscribed circle	T	S	C	D	V
6.35	±0.05	-	-	-	-
9.525	±0.05	±0.05	±0.05	±0.05	±0.05
12.70	±0.08	±0.08	±0.08	±0.08	±0.08
15.875	±0.10	±0.10	±0.10	±0.10	±0.10
19.05	-	-	-	-	±0.10
25.40	-	±0.13	-	-	±0.10
31.75	-	±0.20	-	-	±0.12

3 - Tolerances symbol

A	B	C	D	E
F	G	N	P	O
				Other clearance angle

2 - Normal clearance symbol



4 - Insert symbol															
symbol	Type	Hole type	Chipbreaker	Shape	symbol	Type	Hole type	Chipbreaker	Shape	symbol	Type	Hole type	Chipbreaker	Shape	
W	with hole	Round hole / one countersink (40°~60°)	Without chipbreaker		H	with hole	Round hole / one countersink (70°~90°)	Chipbreaker on one side		G	without hole	Round hole	Chipbreaker on both sides		
T			Chipbreaker on one side		C			Without chipbreaker		N			-	Without chipbreaker	
Q	with hole	Round hole / double countersink (40°~60°)	Without chipbreaker		J	with hole	Round hole / double countersink (70°~90°)	Chipbreaker on both sides		R	without hole	-	Chipbreaker on one side		
U			Chipbreaker on both sides		A			Without chipbreaker		F			-	Chipbreaker on both sides	
B	without hole	Round hole / one countersink (70°~90°)	Without chipbreaker		M	without hole	Round hole	Chipbreaker on one side		X	without hole	-	-	On request	

R's	35° V's	55° D's	80° C's	90° S's	60° T's	80° W's	Ø CI		ANSI
							mm	inch	Symbol
-	06	04	-	03	06	02	3,97	5/32	1,20
-	08	05	04	04	08	L3	4,76	3/16	1,50
-	09	06	05	05	09	03	5,56	7/32	1,80
06**	-	-	-	-	-	-	6,00	0,236	
06*	11	07	06	06	11	04	6,35	1/4	2,00
07*	13	09	08	07	13	05	7,94	5/16	2,50
08*	-	-	-	-	-	-	8,00	0,315	
09*	16	11	09	09	16	06	9,525	3/8	3,00
10**	-	-	-	-	-	-	10,00	0,394	
12**	-	-	-	-	-	-	12,00	0,472	
12*	22	15	12	12	22	08	12,70	1/2	4,00
15*	27	19	16	15	27	10	15,875	5/8	5,00
16**	-	-	-	-	-	-	16,00	0,63	
19*	33	23	19	19	33	13	19,05	3/4	6,00
20**	-	-	-	-	-	-	20,00	0,787	
25**	-	-	-	-	-	-	25,00	0,984	
25*	44	31	25	25	44	17	25,40	1,00	8,00
31*	54	38	32	31	54	21	31,75	1 1/4	10,00
32**	-	-	-	-	-	-	32,00	1,26	

* ANSI designation only (Radius Designation is 00)

** Metric designation only (Radius Designation is M0)

According to International Standard ISO 1832 - 2012(E)

"Indexable inserts for cutting tools - Designation"

ISO	mm	ANSI	inch
01	1.59	1	0.062
T1	1.98	1.2	0.078
02	2.38	1.5	0.094
03	3.18	2	0.125
T3	3.97	2.5	0.156
04	4.76	3	0.188
05	5.56	3.5	0.219
06	6.35	4	0.250
07	7.94	5	0.312
09	9.52	6	0.375
12	12.70	8	0.500

5 - Insert size symbol

6 - Insert thickness symbol



10 - Chipbreaker geometries	
Cutting Condition	Main Application
1st letter	2nd letter
L - Light	P - Steel
M - Medium	M - Stainless Steel
H - Heavy	K - Cast Iron
W - Wiper	N - Aluminium
*only when required.	S - HRSA Titanium Alloys
	H - Hardened Materials

Ex.: ANHX160708PNER - MP

7 - Insert corner symbol			
ISO	mm	inch	ANSI
00	Sharp nose		0
01	0.10	.004	0.2
02	0.20	.008	0.5
04	0.40	.015	1
08	0.80	.032	2
12	1.2	.047	3
16	1.6	.062	4
20	2.0	.078	5
24	2.4	.094	6
28	2.8	.109	7
32	3.2	.125	8
00 (inch or M0/metric)	Round insert		0

7.1* - Insert edges symbol			
For inserts having secondary edges two digits are used:			
1st digit is secondary edge		2nd digit is secondary edges relief angle	
A	45°	A	3°
D	60°	B	5°
E	75°	C	7°
F	85°	D	15°
P	90°	E	20°
Z	special	F	25°
		G	30°
*only when required.		N	0°
		P	11°
		Z	special

8* - Cutting edge information		
Shape	Honing	Symbol
	No honing	F
	With honing	E
	Chamfered No honing	T
	Chamfered with honing	S
*only when required.		

9 - Cutting direction		
Shape	Hand	Symbol
	Right	R
	Left	L
	None	N

A new step on coating innovation!

NEW

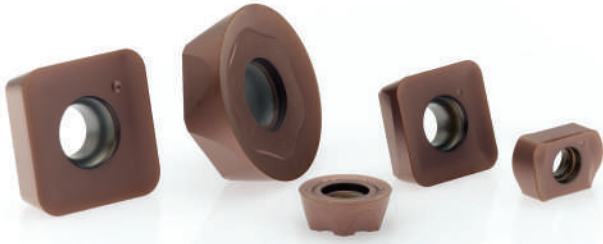

PHH603 NEW
H05-H15
P01-P05

Recommended for finishing operations in steels and hardened steels. First choice in mold and die finishing applications.

PHH910 NEW
P05-P10
H15-H30

Recommended for finishing operations in steels and hardened steels in unstable conditions.

PHH930 NEW
M20-M40
S20-S30

Recommended for general purpose milling of stainless steels and HRSA.

PHH530 NEW
M25-M40
S25-S35

Extremely heat resistant grade. First choice in hot-section turbine blade milling.

PHH808 NEW
M30-M40
S30-S40

High heat resistance grade. Economic choice in hot-section turbine blade milling.

A new step on coating innovation!

NEW

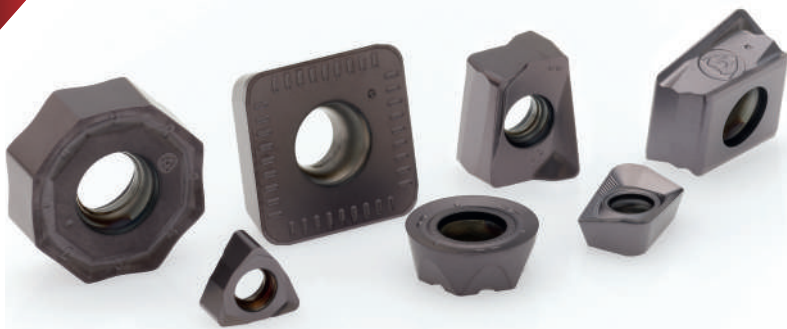

PHP910 NEW
P05-P10
K05-K10

Recommended for light operations in steels.

PHP920 NEW
P10-P35
K10-K30

Recommended for General Steel & Cast Iron Milling.

PHP930 NEW
P20-P40
K20-K40

Recommended for medium to roughing operations in steels and cast irons.

PHP530 NEW
P25-P40
M25-M40

Extremely heat resistant grade. First choice in cold-section turbine blade milling.

PHP808 NEW
P30-P40

High heat resistance grade. Economic choice for cold-section turbine blade milling.

PH	X	X	XX
PH - Palbit Hardmetal PD - Palbit diamond PB - Palbit PCBN	Coating PCD PCBN Grade	1 - Steel 2 - Stainless steel 3 - Cast Iron 4 - Non Ferrous 5 - Super Alloys 6 - Hardened Materials 7 - Wearparts 9 - Universal Range	01 - ISO Field (...) 50 - ISO Field

A

MILLING

Overview

Face milling

Hi-feed milling

Shoulder milling

Profile milling

Hardmill

Center & Chamfer

Spot face

Spare Parts

Technical Data

End Mills

MILLING INSERTS OVERVIEW

A

MILLING

Overview

Face milling

Hifeed milling

Shoulder milling

Profile milling

Hardmill

Center & Chamfer



Spot face

Spare Parts



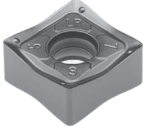
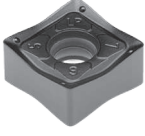

Technical Data

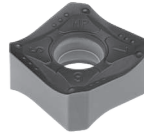
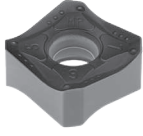
End Mills

FACE MILLING INSERTS

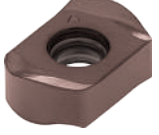
Reference	SNHU	SNKU	PNHX	PNKX	SNHX	SNKX
	Proprietary milling insert	Proprietary milling insert	Proprietary milling insert	Proprietary milling insert	Proprietary milling insert	Proprietary milling insert
						
Size	12	12	11	11	12 16	12 16
Material	P M K	P M K	P K	P K	P M K N S	P K
Page	56	56	61	61	65 69 73	65 69 73

HIFEED MILLING INSERTS



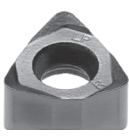
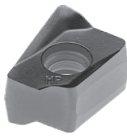
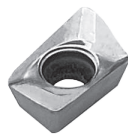
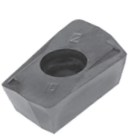

Reference	XNKU NEW	POKT	SOEW	SOET	WDET
	Proprietary milling insert	Proprietary milling insert	Proprietary milling insert		
					
Size	06	04	08 13 16	08 13 16	12
Material	P M K S	P K	P K	P M S	P M S
Page	85	89	93 99 104	93 99 104	109



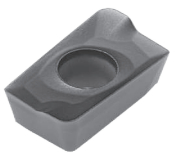
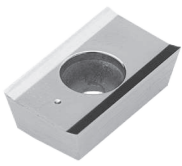

SHOULDER MILLING INSERTS



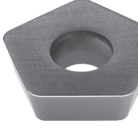
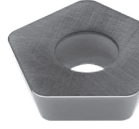

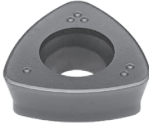
Reference	WNXT NEW	WNHU	ANHX	XPET	XPHW
	Proprietary milling insert	Proprietary milling insert	Proprietary milling insert	Proprietary milling insert	Proprietary milling insert
					
Size	08	04	10 12 16	06 10 17	06 10
Material	P K	P K	P M K N S	P M K N S	P H
Page	121	196	126 132 135	139 147 153	139 147

SHOULDER MILLING INSERTS

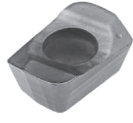
Reference	APKT	APHT
		
Size	10 16	16
Material	P M K N	N
Page	181 187	187

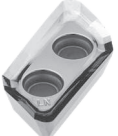
FACE MILLING INSERTS						
Reference	ONHX	ONKX	SEHW	SEHT	PDMW	PDHW
	Proprietary milling insert 	Proprietary milling insert 				
Size	05 06	05 06	12 13	12 13	12	12
Material	P M K S	P M K S	P M K	P M K N	P	P K
Page	65 73	45 73	73 79	73 79	82	82

HIFED MILLING INSERTS					
Reference	WDMW	WNMW	SPKW	SPKT	XPET...HF
					Proprietary milling insert 
Size	12	12	08	08	06 10
Material	P K	P K	P K	P M K	P M K S
Page	109	113	117	117	139 147

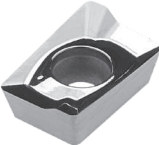
SHOULDER MILLING INSERTS						
Reference	LNXT	XDGX	VCGX	SPGX ^{NEW}	SPMX ^{NEW}	APET
	Proprietary milling insert 					
Size	09 13 15	15 22	22	12	12	10
Material	P M K	N	N	P M K S	P M K S	N
Page	158 161 165	169 173	176	178	178	181

A
MILLING
Overview
Face milling
Hifed milling
Shoulder milling
Profile milling
Hardmill
Center & Chamfer
Spot face
Spare Parts
Technical Data
End Mills

MILLING INSERTS OVERVIEW

A

MILLING

Overview

Face milling

Hifeed milling

Shoulder milling

Profile milling

Hardmill

Center & Chamfer







Spot face

Spare Parts





Technical Data

End Mills

PROFILE MILLING INSERTS

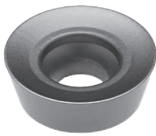
Reference	WCR ^{NEW} Proprietary milling insert	WCL ^{NEW} Proprietary milling insert	WNHU Proprietary milling insert	RDHT Proprietary milling insert	RPHT Proprietary milling insert	RNHX Proprietary milling insert
						
Size	08 10 12 16 20	08 10 12 16 20	04 06	08	10 12 16 20	12
Material	P M K N S H	P M K N S H	P K H	P M S	P M S	P M K S
Page	191 192	191 192	125 196	203	203	211

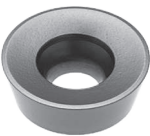
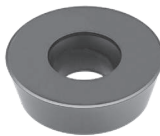



PROFILE MILLING INSERTS

Reference	RDHT	RDHW	RDMT	RDMW	XDHW	XPGT ^{NEW} Proprietary milling insert
						
Size	10 12 16 20	07 10 12 16 20	10 12 20	10 12 16 20	04 06 10	32
Material	P K	P K H	P	P K	P K N H	P K
Page	217	217	217	217	223	194

HARDMILL MILLING INSERTS

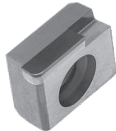
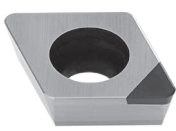
CENTER & CHAMFER INSERTS

SPOT FACE

Reference	XNHW	XDHW	SOMT	SOGT ^{NEW}	SPKX
					
Size	12	04 06 10	11	11	05 06 07 09 11
Material	K N	N H	P M K	P M K	P M K S
Page	229	223	230	230	232

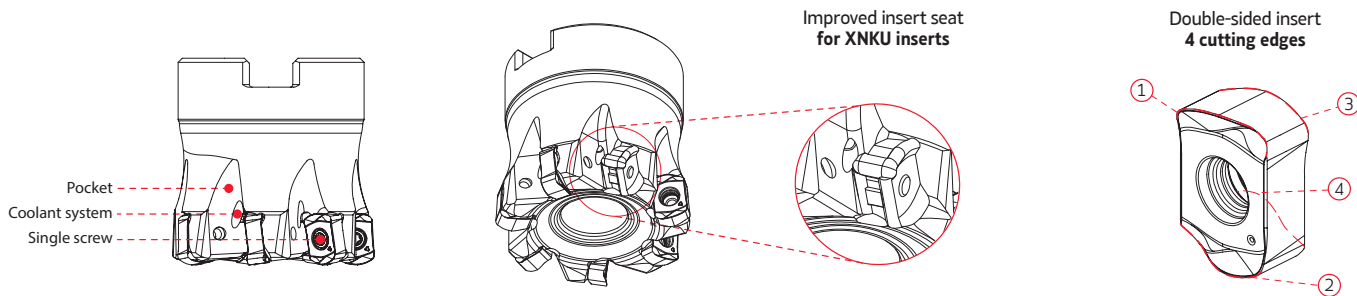

MILLING CUTTER

Design

- Optimized design for better chip evacuation;

Pocket

- Strong pocket design for better cutter body durability;
- Improved insert seat;

INSERT

Insert Width

- Large cross section;

Cutting edge

- Improved cutting edge;
- Improved wear resistance;

Double-sided insert

- Double-sided insert with 4 cutting edges;

XNKU 06T3

XNKU-MP

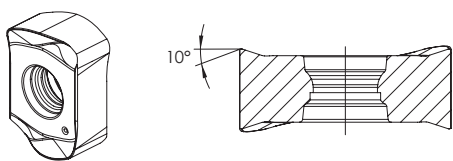





GEOMETRY FEATURES | Características geométricas | Características geométricas

Geometry	Features Características Características
Geometry MP General machining	Geometry with a reinforced cutting edge for general applications on different materials.

All information: Page - 84

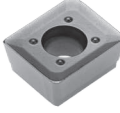
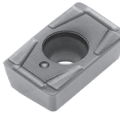
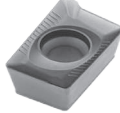
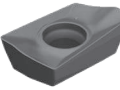
MILLING INSERTS OVERVIEW

A
 MILLING
 Overview
 Face milling
 Hi-feed milling
 Shoulder milling
 Profile milling
 Hardmill
 Center & Chamfer
 Spot face
 Spare Parts
 Technical Data
 End Mills

Inserts Pastilhas Plaquitas	(1) Geometry code	(2) Grade code ISO Reference	P							M			K							N	
			PVD							PVD			CVD		PVD					UNC	UNC
			M6	54	68	66	78	86	I5	68	66	I5	L5	L9	D2	54	68	67	I5	17	10
PH6103	PH6910	PH6920	PH6930	PH6125	PH6135	PH6740	PH6920	PH6930	PH6740	PH5705	PH5740	PH6705	PH6910	PH6920	PH6325	PH6740	PH0325	PH0910			
	1111423	ACET 150612 TR			⊗					⊗											
	1110014	APFT 1604 PDRF			○																
	1110015	APFT 1604 PDSR			⊗																
	1110557	APFT 1604 PDTR			○																
	1110006	ADKT 1505 PDR			⊗	○				⊗	○						○	○			
	1111218	ADKT 1505 PDSR			⊗	⊗				⊗	⊗						⊗	⊗			
	1111209	ADKT 1505 PDTR			⊗	○				○	○						⊗	○			
	1112192	BOMT 130408R			○												○				
	1110038	BCKT 1304 PDR								⊗											
	1110922	HNGF 090520 - V																○	⊗		
	1110957	HNGF 090520 - W																○			

⊗ First choice | Primeira opção | 1ª opção
 ⊗ Stock item | Produto de stock | Itens de stock
 ○ Available under request (see page A-9) | Disponível sobre consulta (consulte a página A-9) | Disponible bajo consulta (mire pagina A-9)
 Insert order code = (1) Geometry Code + (2) Grade Code

Dimensions (mm) Dimensões (mm) Dimensiones (mm)						Drawing
ic	S	I	R	a	F	
12,7	6,35	15,00	1,20	-	1,70	
9,53	4,76	16,00	0,80	-	2,00	
9,53	4,76	16,00	0,80	-	2,00	
9,53	4,76	16,00	0,80	-	2,00	
9,54	5,63	15,70	-	-	1,60	
9,54	5,63	15,70	-	-	1,60	
9,54	5,63	15,70	-	-	1,60	
8,13	4,85	11,50	1,20	-	1,40	
8,41	4,90	12,80	0,61	-	1,40	
16,20	5,56	9,16	2,00	-	-	
16,20	5,56	9,16	2,00	-	-	

MILLING INSERTS OVERVIEW

A	MILLING	Inserts Pastilhas Plaquitass	(1) Geometry code	(2) Grade code	P								M			K					N		
					PVD								PVD			CVD		PVD			UNC	UNC	
					M6	54	68	66	78	86	15	68	66	15	L5	L9	D2	54	68	67	15	17	10
ISO Reference		PH6103	PH6910	PH6920	PH6930	PH6125	PH6135	PH6740	PH6920	PH6930	PH6740	PH5705	PH5740	PH6705	PH6910	PH6920	PH6325	PH6740	PH0325	PH0910			
Overview		1111876	LNE 323-02																				
		1111877	LNE 323-10																○				
																		○					
Face milling		1110952	LNE 323-02 SP																				
Hifeed milling		1111420	LNE 434-02																				
Shoulder milling		1111416	LNJN 2205 DDSR-A1																				
Profile milling		1111518	OFEN 070405 TN			⊗	⊗																
Hardmill		1111569	OFKR 070408 FN-LN																			⊗	
Center & Chamfer		1111568	OFKR 070408 SN-MP			⊗	⊗																
Spot face																							
Spare Parts		1112133	RPEW 1204 M0																				
Technical Data		1121742	RPMT 1003 M0T																				
		1120448	RPMT 1204 M0T																				

⊗ First choice | Primeira opção | 1ª opción

⊛ Stock item | Produto de stock | Itens de stock

○ Available under request (see page A-9) | Disponível sobre consulta (consulte a página A-9) | Disponible bajo consulta (mire pagina A-9)

Insert order code = (1) Geometry Code + (2) Grade Code

Dimensions (mm) Dimensões (mm) Dimensiones (mm)						Drawing
ic	S	L	R	a	F	
9,53	4,76	15,88	-	-	0,40	
9,53	4,76	15,88	1,27	-	-	
9,53	4,76	15,88	0,80	-	1,20	
14,28	6,35	19,05	-	-	0,80	
14,00	5,00	22,00	-	2,00	-	
18,00	4,76	7,40	0,60	-	2,20	
18,00	4,76	7,40	0,60	-	2,20	
18,00	4,76	7,40	0,60	-	1,60	
12,00	4,76	-	-	-	-	
10,00	3,18	-	-	-	-	
12,00	4,76	-	-	-	-	

A

MILLING

Overview

Face milling

Hifeed milling

Shoulder milling

Profile milling

Hardmill

Center & Chamfer

Spot face

Spare Parts

Technical Data

End Mills

MILLING INSERTS OVERVIEW

A	MILLING	Inserts Pastilhas Plaquetas	(1) Geometry code	(2) Grade code	P								M			K					N	
					PVD								PVD			CVD	PVD					UNC
					M6	54	68	66	78	86	15	68	66	15	L9	D2	54	68	67	15	17	10
PH6103	PH6910	PH6920	PH6930	PH6125	PH6135	PH6740	PH6920	PH6930	PH6740	PH5740	PH6705	PH6910	PH6920	PH6325	PH6740	PH0325	PH0910					
	1110200	SDHT 1204 AEEN																				
	1110693	SDHT 1204 AFFN																				
	1110201	SDHT 1204 AESN-PL																				
	1110818	SDHW 09T3 AEEN																				
	1110743	SDHW 09T3 AEFN																				
	1110781	SDHW 1204 AEEN																				
	1110782	SDHW 1204 AETN																				
	1112339	SDHW 150412																				
	1110206	SEAN 1203 AFEN																				
	1110207	SEAN 1203 AFFN																				
	1110208	SEAN 1203 AFSN																				
	1110209	SEAN 1203 AFTN																				
	1110211	SEAN 1504 AFFN																				
	1110212	SEAN 1504 AFTN																				
	1110224	SEHW 1504 AFSN																				
	1110225	SEHW 1504 AFTN																				
	1110226	SEKN 1203 AFEN																				
	1110227	SEKN 1203 AFFN																				
	1110228	SEKN 1203 AFSN																				
	1110230	SEKN 1203 AFTN																				
	1110794	SEKN 1204 AFFN																				
	1110232	SEKN 1204 AFSN																				
	1110233	SEKN 1204 AFTN																				
	1110235	SEKN 1504 AFEN																				
	1110238	SEKN 1504 AFTN																				
	1110239	SEKR 1203 AFEN																				
	1110240	SEKR 1203 AFSN																				
	1110241	SEKR 1204 AFSN																				
	1110759	SEKR 1504 AFSN																				
	1111921	SEXT 14M4 AGSN-M																				

First choice | Primeira opção | 1ª opción
 Stock item | Produto de stock | Itens de stock
 Available under request (see page A-9) | Disponível sobre consulta (consulte a página A-9) | Disponible bajo consulta (mire página A-9)
 Insert order code = (1) Geometry Code + (2) Grade Code

Dimensions (mm) Dimensões (mm) Dimensiones (mm)						Drawing
ic	S	I	R	a	F	
12,70	4,76	10,00	-	-	1,80	
12,70	4,76	10,00	-	-	1,80	
12,70	4,76	10,00	-	-	1,80	
9,53	3,97	7,30	0,30	-	1,50	
9,53	3,97	7,30	0,30	-	1,50	
12,70	4,76	9,00	-	-	2,50	
12,70	4,76	9,00	-	-	2,50	
15,88	4,76	-	1,20	-	-	
12,70	3,18	9,20	0,80	-	2,40	
12,70	3,18	9,20	0,80	-	2,40	
12,70	3,18	9,20	1,20	-	2,40	
12,70	3,18	9,20	1,20	-	2,40	
15,88	4,76	11,60	1,00	-	2,40	
15,88	4,76	11,60	1,00	-	2,40	
15,88	4,76	11,60	0,20	-	2,80	
15,88	4,76	11,60	0,20	-	2,80	
12,70	3,18	9,20	1,20	-	2,40	
12,70	3,18	9,20	1,20	-	2,40	
12,70	3,18	9,20	1,20	-	2,40	
12,70	3,18	9,20	1,20	-	2,40	
12,70	4,76	9,20	1,20	-	2,40	
12,70	4,76	9,20	1,20	-	2,40	
12,70	4,76	9,20	1,20	-	2,40	
15,88	4,76	12,30	1,00	-	2,40	
15,88	4,76	12,30	1,00	-	2,40	
12,70	3,18	9,20	1,20	-	2,40	
12,70	3,18	9,20	1,20	-	2,40	
12,70	4,76	9,20	1,20	-	2,40	
15,88	4,76	12,30	1,00	-	2,40	
14,00	4,00	9,20	1,00	-	2,80	

A

MILLING

Overview

Face milling

Hi-feed milling

Shoulder milling

Profile milling

Hardmill

Center & Chamfer

Spot face

Spare Parts

Technical Data

End Mills

MILLING INSERTS OVERVIEW

A	MILLING	Inserts Pastilhas Plaquitas	(1) Geometry code	(2) Grade code	P				M			K					N			
					PVD				PVD			CVD	PVD			UNC	UNC			
					M6	54	68	66	78	86	15	68	66	15	L9	D2	54	68	67	15
PH6103	PH6910	PH6920	PH6930	PH6125	PH6135	PH6740	PH6920	PH6930	PH6740	PH5740	PH6705	PH6910	PH6920	PH6325	PH6740	PH0325	PH0910			
Overview		1110266	SNGN 120408																	
		1110267	SNGN 120412																	
		1110597	SNGN 190412																	
		1110598	SNGN 190416																	
Face milling		1110271	SNKN 1204 ENEN																	
		1110273	SNKN 1204 ENSN																	
Hi-feed milling		1120541	SNUN 120404																	
		1120542	SNUN 120408																	
		1120544	SNUN 120412																	
		1121880	SNUN 190612T																	
Hardmill		1110765	SPGN 090312																	
		1111173	SPGN 090316																	
		1110300	SPGN 120308																	
		1110301	SPGN 120312																	
		1110303	SPGN 120408																	
		1110588	SPGN 120412																	
		1110590	SPGN 150408																	
		1110304	SPGN 150412																	
Center & Chamfer		1110326	SPKN 1203 EDFR																	
		1110328	SPKN 1203 EDSR																	
		1110330	SPKN 1203 EDTR																	
		1110331	SPKN 1204 EDER																	
		1110332	SPKN 1204 EDSR																	
		1110333	SPKN 1204 EDTR																	
Spare Parts		1110336	SPKN 1504 EDER																	
		1110337	SPKN 1504 EDFR																	
		1110339	SPKN 1504 EDSR																	
		1110340	SPKN 1504 EDTR																	
		1110335	SPKN 1504 EDEL																	
		1110338	SPKN 1504 EDSL																	

Continue next page | Continúa na próxima página | Sigue en la página siguiente

⊗ First choice | Primeira opção | 1ª opción
⊗ Stock item | Produto de stock | Itens de stock
○ Available under request (see page A-9) | Disponível sobre consulta (consulte a página A-9) | Disponible bajo consulta (mire página A-9)
Insert order code = (1) Geometry Code + (2) Grade Code

Dimensions (mm) Dimensões (mm) Dimensiones (mm)						Drawing
ic	S	l	R	a	F	
12,70	4,76	-	0,80	-	-	
12,70	4,76	-	1,20	-	-	
19,05	4,76	-	1,20	-	-	
19,05	4,76	-	1,60	-	-	
12,70	4,76	-	-	1,50	0,80	
12,70	4,76	-	-	1,50	0,80	
12,70	4,76	11,10	0,40	-	-	
12,70	4,76	11,10	0,80	-	-	
12,70	4,76	11,10	1,20	-	-	
19,05	6,35	-	1,20	-	-	
9,53	3,18	-	1,20	-	-	
9,53	3,18	-	1,60	-	-	
12,70	3,18	-	0,80	-	-	
12,70	3,18	-	1,20	-	-	
12,70	4,76	-	0,80	-	-	
12,70	4,76	-	1,20	-	-	
15,88	4,76	-	0,80	-	-	
15,88	4,76	-	1,20	-	-	
12,70	3,18	12,70	-	1,00	1,50	
12,70	3,18	12,70	-	1,00	1,50	
12,70	3,18	12,70	-	1,00	1,50	
12,70	4,76	12,70	-	1,00	1,50	
12,70	4,76	12,70	-	1,00	1,50	
12,70	4,76	12,70	-	1,00	1,50	
15,88	4,76	15,88	-	1,00	1,50	
15,88	4,76	15,88	-	1,00	1,50	
15,88	4,76	15,88	-	1,00	1,50	
15,88	4,76	15,88	-	1,00	1,50	

A

MILLING

Overview

Face milling

Hifeed milling

Shoulder milling

Profile milling

Hardmill

Center & Chamfer

Spot face

Spare Parts

Technical Data

End Mills

MILLING INSERTS OVERVIEW

A	MILLING	MILLING INSERTS OVERVIEW																		
		Inserts Pastilhas Plaquitas	(1) Geometry code	(2) Grade code	P					M			K				S			
					PVD					PVD			CVD		PVD				UNC	PVD
					M6	54	68	66	86	15	68	66	15	L5	L9	D2	54	68	67	15
PH6103	PH6910	PH6920	PH6930	PH6135	PH6740	PH6920	PH6930	PH6740	PH5705	PH5740	PH6705	PH6910	PH6920	PH6325	PH6740	PH0325	PH6740			
	1111976	SPKR 1203 EDTR			○															
	1110564	SPKR 1504 EDFR			○															
	1111449	SPKR 1504 EDSR			○															
	1111107	SPKR 1906			○															
	1111195	SPKT 130510-E			⊗															
	1111153	SPKW 130510 F		○	○															
	1111355	SPKW 130510-E			⊗															
	1110888	SPKW 130510-S			⊗															
	1111609	SPMT 120408-MP			⊗						⊗							⊗	⊗	
	1120572	SPMW 120408			○						⊗						○		⊗	
	1191186	SPXN 1906			○			○	○						○			○		
	1112384	SPXN 1906-W			○													○		
	1112134	SPXR 1203 EDSR-MP			⊗													⊗	⊗	
	1110393	TNHF 1204 AN-CA											⊗	⊗	⊗	⊗		○		
	1111333	TNHF 1204 AN-K											⊗	⊗				⊗		

⊗ First choice | Primeira opção | 1ª opção
 ⊗ Stock item | Produto de stock | Itens de stock
 ○ Available under request (see page A-9) | Disponível sobre consulta (consulte a página A-9) | Disponible bajo consulta (mire página A-9)
 Insert order code = (1) Geometry Code + (2) Grade Code

Dimensions (mm) Dimensões (mm) Dimensiones (mm)						Drawing
ic	S	I	R	a	F	
12,70	3,18	12,70	-	1,00	1,40	
15,88	4,76	15,88	-	1,00	1,40	
15,88	4,76	15,88	-	1,00	1,40	
19,05	6,35	19,05	-	1,00	1,40	
13,00	5,56	-	1,00	-	-	
13,00	5,56	-	1,00	-	-	
13,00	5,56	-	1,00	-	-	
13,00	5,56	-	1,00	-	-	
12,70	4,76	-	0,8	-	-	
12,70	4,76	-	0,8	-	-	
19,05	6,35	19,05	-	1,00	1,40	
19,05	6,35	-	-	-	12,00	
12,70	3,18	12,70	1,00	1,00	1,37	
12,70	4,76	12,00	2,00	-	1,70	
12,70	4,76	12,00	3,00	-	1,30	

A

MILLING

Overview

Face milling

Hi-feed milling

Shoulder milling

Profile milling

Hardmill

Center & Chamfer

Spot face

Spare Parts

Technical Data

End Mills

MILLING INSERTS OVERVIEW

A	MILLING	Inserts Pastilhas Plaquetas	(1) Geometry code	(2) Grade code	P						M			K					
					PVD						CVD			CVD		PVD			UNC
					54	68	G4	66	I5	G6	L8	L9	68	66	I5	L5	L9	54	68
PH6910	PH6920	PH7920	PH6930	PH6740	PH7740	PH5125	PH5740	PH6920	PH6930	PH6740	PH5705	PH5740	PH6910	PH6920	PH6325	PH6740	PH0325		
Overview		1111911	TNJV 1204 ANEN		○											○			
Face milling		1110422	TPGN 110304		○											○			
		1110423	TPGN 110308		○											○			
		1110425	TPGN 160304		⊗											⊗			
		1110426	TPGN 160308		⊗											⊗			
Hi-feed milling		1110450	TPKN 1603 PDEL		○											○			
		1110451	TPKN 1603 PDER		⊗			⊗								⊗		⊗	
		1110671	TPKN 1603 PDSR		○											○			
		1110455	TPKN 1603 PDTR		⊗			⊗								⊗		⊗	
		1110459	TPKN 1603 PPFN		○											○			
Shoulder milling		1110463	TPKN 1603 PPTR		○										○				
		1110465	TPKN 2204 PDER		⊗			⊗							⊗		⊗		
		1110466	TPKN 2204 PDFR		○											○		⊗	
		1110609	TPKN 2204 PDSR		⊗			⊗							⊗		⊗		
		1110471	TPKN 2204 PPSR		○											○			
Profile milling		1110468	TPKN 2204 PDTR		○										○				
Hardmill		1110476	TPKR 1603 PDSR		⊗			⊗							⊗		⊗		
		1110477	TPKR 2204 PDSR		⊗			⊗							⊗		⊗		
Center & Chamfer		1120761	TPUN 110304		○														
		1120762	TPUN 110308		○														
		1120765	TPUN 160304			⊗			○	⊗	⊗								
		1120766	TPUN 160308			⊗			⊗	⊗	⊗								
		1120770	TPUN 160312		○				○	⊗	⊗								
		1120777	TPUN 220404		○				○	⊗	⊗								
		1120779	TPUN 220408		○				⊗	⊗	⊗								
		1120783	TPUN 220412		○				⊗	⊗	⊗								
Spotface		1120791	TPUN 270616						○										
Spare Parts		1112135	TPXR 2204 PDSR-MP		⊗			⊗							⊗		⊗		

⊗ First choice | Primeira opção | 1ª opción
 ⊗ Stock item | Produto de stock | Itens de stock
 ○ Available under request (see page A-9) | Disponível sobre consulta (consulte a página A-9) | Disponible bajo consulta (mire página A-9)
 Insert order code = (1) Geometry Code + (2) Grade Code

Dimensions (mm) Dimensões (mm) Dimensiones (mm)						Drawing
ic	S	I	R	a	F	
12,70	4,76	12,00	-	-	2,50	
6,35	3,18	-	0,40	-	-	
6,35	3,18	-	0,40	-	-	
9,53	3,18	-	0,40	-	-	
9,53	3,18	-	0,80	-	-	
9,53	3,18	16,50	0,70	-	1,20	
9,53	3,18	16,50	0,70	-	1,40	
9,53	3,18	16,50	0,70	-	1,20	
9,53	3,18	16,50	0,70	-	1,40	
9,53	3,18	16,50	-	-	1,10	
9,53	3,18	16,50	-	-	1,10	
12,70	4,76	22,00	0,50	-	1,70	
12,70	4,76	22,00	0,50	-	1,70	
12,70	4,76	22,00	0,50	-	1,70	
12,70	4,76	22,00	-	-	1,40	
12,70	4,76	22,00	-	-	1,40	
9,53	3,18	16,50	0,60	-	1,20	
12,70	4,76	22,00	0,50	-	1,70	
6,35	3,18	11,00	0,40	-	-	
6,35	3,18	11,00	0,80	-	-	
9,53	3,18	16,50	0,40	-	-	
9,53	3,18	16,50	0,80	-	-	
9,53	3,18	16,50	1,20	-	-	
12,70	4,76	22,00	0,40	-	-	
12,70	4,76	22,00	0,80	-	-	
12,70	4,76	22,00	1,20	-	-	
15,88	6,35	27,00	1,60	-	-	
12,70	4,76	22,00	1,00	-	1,70	

A

MILLING

Overview

Face milling

Hifeed milling

Shoulder milling

Profile milling

Hardmill

Center & Chamfer





Spot face

Spare Parts

Technical Data

End Mills

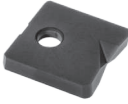
MILLING INSERTS OVERVIEW

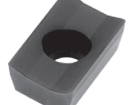
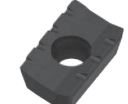
A	MILLING	Inserts Pastilhas Plaquetas	(1) Geometry code	(2) Grade code	P								M			K						
					PVD								PVD			CVD		PVD				UNC
					M6	54	68	66	78	86	15	68	66	15	L5	L9	D2	54	68	67	15	17
PH6103	PH6910	PH6920	PH6930	PH6125	PH6135	PH6740	PH6920	PH6930	PH6740	PH5705	PH5740	PH6705	PH6910	PH6920	PH6325	PH6740	PH0325					
Overview		1110851	WPB 08		○	○	○															
		1110852	WPB 10		○	○	○															
		1110853	WPB 12		○	○	○															
		1110923	WPB 16		○	○	○															
		1111019	WPB 20		○	○	○															
Face milling		1111554	WPRX-2 08			○	○															
		1111331	WPRX-2 10		⊗	⊗																
		1111555	WPRX-2 12		⊗	⊗																
		1111329	WPRX-2 16		⊗	⊗																
		1111330	WPRX-2 20		⊗	⊗																
		1111556	WPRX-2 25		⊗	⊗																
		1111557	WPRX-2 32		⊗	⊗																
Shoulder milling		1110820	WPV 08		○	○	○															
		1110821	WPV 10		○	○	○															
		1110822	WPV 12		○	○	○															
		1110948	WPV 16		○	○	○															
		1111020	WPV 20		○	○	○															
Profile milling		1110543	WPZ 08		⊗	○	○															
		1110551	WPZ 10		⊗	○	○															
		1110552	WPZ 12		⊗	○	○															
		1110544	WPZ 16		⊗	⊗	○															
		1110553	WPZ 20		⊗	⊗	○															
		1110661	WPZ 25		⊗	⊗	○															
		1110662	WPZ 32		⊗	⊗	○															
Center & Chamfer		1110910	XPHT 1604 PDTR				○															
		1111206	XPHT 160420 PPTR					○														
		1110926	XPHT 160432 PDSR						○													
Spotface		1110958	XPHT 160412-MR					○														

⊗ First choice | Primeira opção | 1ª opción
 ⊗ Stock item | Produto de stock | Itens de stock
 ○ Available under request (see page A-9) | Disponível sobre consulta (consulte a página A-9) | Disponible bajo consulta (mire página A-9)
 Insert order code = (1) Geometry Code + (2) Grade Code

Dimensions (mm) Dimensões (mm) Dimensiones (mm)						Drawing
ic	S	I	R	a	F	
8,00	2,00	9,50	0,60	4,00	-	
10,00	2,50	11,50	0,80	5,00	-	
12,00	2,50	14,00	1,00	6,00	-	
16,00	3,00	16,00	1,30	6,00	-	
20,00	3,00	20,00	1,60	6,00	-	
8,00	2,00	9,50	-	2,50	-	
10,00	2,50	11,50	-	5,00	-	
12,00	2,50	11,90	-	6,00	-	
16,00	3,00	13,90	-	6,00	-	
20,00	3,00	15,90	-	6,00	-	
25,00	4,00	21,30	-	9,00	-	
32,00	5,00	25,80	-	10,00	-	
8,00	2,00	9,50	0,60	4,00	-	
10,00	2,50	11,50	0,80	5,00	-	
12,00	2,50	14,00	1,00	6,00	-	
16,00	3,00	16,00	1,30	6,00	-	
20,00	3,00	20,00	1,60	6,00	-	
8,00	2,40	7,00	-	3,00	-	
10,00	2,60	8,50	-	3,50	-	
12,00	3,00	10,00	-	4,00	-	
16,00	4,00	12,00	-	4,00	-	
20,00	5,00	15,00	-	5,00	-	
25,00	6,00	18,50	-	6,00	-	
32,00	7,00	23,50	-	7,50	-	
9,53	4,75	16,00	1,20	-	1,70	
9,53	4,75	16,00	2,00	-	0,70	
9,53	4,75	16,00	3,20	-	-	
9,53	4,75	16,00	1,20	-	1,70	

A

MILLING

Overview

Face milling

Highfeed milling

Shoulder milling

Profile milling

Hardmill

Center & Chamfer

Spot face

Spare Parts

Technical Data

End Mills

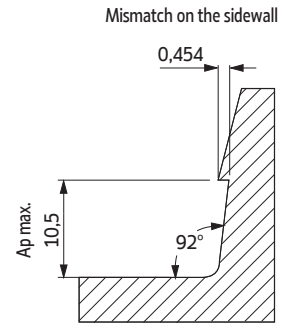
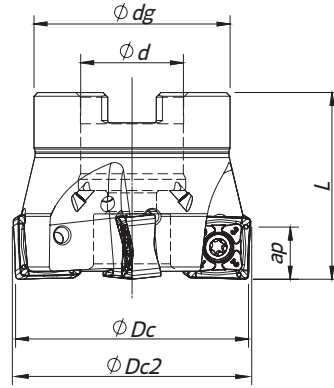
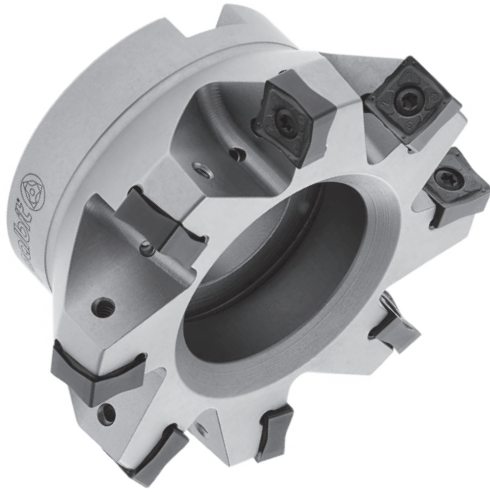

Arbor Mounting
 $K_r=88^\circ$ | $\gamma_p=-6^\circ$

Order code Código	Reference Referência Referencia		Dimensions Dimensões Dimensiones (mm)					Kg	Specifications		Insert Pastilha Inserto	Stock
			ϕDc	$\phi Dc2$	ϕd	ϕdg	L		Arbor Type	Ap max (mm)		
181084300	050A28088-05-06-022040	5	50	50,9	22	42	40	0,4	A	10,5	SN... 1206...	
181091600	063A28088-06-06-022040	6	63	63,9	22	48	40	0,5	A	10,5	SN... 1206...	
181091700	080A28088-07-06-027050	7	80	80,9	27	60	50	1,0	A	10,5	SN... 1206...	
181091800	080A28088-09-06-027050	9	80	80,9	27	60	50	0,9	A	10,5	SN... 1206...	
181091900	100A28088-08-06-032050	8	100	100,9	32	73	50	1,6	B	10,5	SN... 1206...	
181092000	100A28088-11-06-032050	11	100	100,9	32	73	50	1,5	B	10,5	SN... 1206...	
181092100	125A28088-10-06-040063	10	125	125,9	40	90	63	3,1	B	10,5	SN... 1206...	
181092200	125A28088-14-06-040063	14	125	125,9	40	90	63	3,0	B	10,5	SN... 1206...	
181092300	160A28088-12-06-U040063	12	160	160,9	40	110	63	3,7	C	10,5	SN... 1206...	
181092700	160A28088-18-06-U040063	18	160	160,9	40	110	63	3,5	C	10,5	SN... 1206...	
181092800	200A28088-14-06-U060063	14	200	200,9	60	172	63	6,3	C	10,5	SN... 1206...	
181092900	200A28088-22-06-U060063	22	200	200,9	60	172	63	6,1	C	10,5	SN... 1206...	

Stock item | Produto de stock | Itens de stock

Available under request (see page A-9) | Disponível sobre consulta (consulte a página A-9) | Disponible bajo consulta (mire página A-9)

SPARE PARTS | Complementos | Repuestos

Cutter ϕDc	Insert Screw	Key (Torx)	Order separately		Order separately	
			Key (Torx - Nm)	Torque Value	Screw	DIN 6368 Wrench
A28088 - 50 - 80	P0401200	XT15	DT1530	3,0	-	-
A28088 - 100	P0401200	PT15	DT1530	3,0	J0164110	SD6368-16
A28088 - 125	P0401200	PT15	DT1530	3,0	J0204610	SD6368-20
A28088 - 160 - 200	P0401200	PT15	DT1530	3,0	-	-

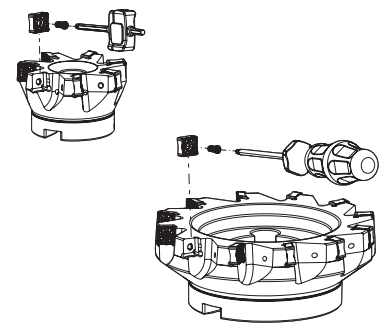

Note: The toolholder is supplied with the XT/PT key. To order the DT key please check the page A-241.
 Check the procedures for the clamping screws on the page A-241.

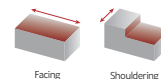

SNH(K)U 1206 | Inserts | Pastilhas | Plaquetas

SNHU-LP
(PHP grade)

SNKU-LP
(PHP grade)

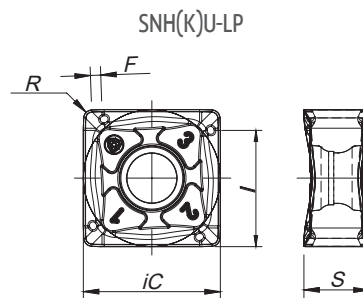
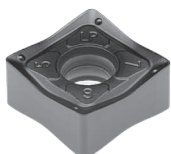
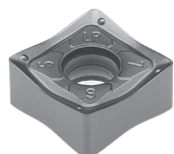

Geometry code	ISO Reference	P		M		K										Dimensions Dimensões Dimensiones (mm)										
		CVD		PVD				CVD		PVD						iC	S	I	R	F						
		T9	G4	T1	P3	G6	G3	G6	L5	L6	L9	T9	G4	T1	P3						G6					
1112020	SNHU 120608 ZNER-LP	⊗	⊗	⊗	⊗	⊗	⊗	⊗	⊗	⊗	⊗	⊗	⊗	⊗	⊗	⊗	⊗	⊗	⊗	⊗	⊗	13,30	6,35	11,60	0,80	1,00
1112278	SNKU 120608 ZNER-LP	⊗	⊗	⊗	⊗	⊗	⊗	⊗	⊗	⊗	⊗	⊗	⊗	⊗	⊗	⊗	⊗	⊗	⊗	⊗	⊗	13,30	6,35	11,60	0,80	1,00

⊗ First choice | Primeira opção | 1ª opción ⊗ Stock item | Produto de stock | Itens de stock ○ Available under request (see page A-9) | Disponível sobre consulta (consulte a página A-9) | Disponible bajo consulta (mire página A-9) Insert order code = (1) Geometry Code + (2) Grade Code

GRADES SELECTION GUIDE | Guia para selecção de graus | Tabla para selección de calidades

ISO	PSM	Material	HB (Brinell)	Grades									
				← Wear Resistance				Toughness →					
				PH5705	PH5320	PHP920	PH7920	PH7930	PH5740	PHS740	PH7740		
P	1	Unalloyed Steel	125-220	⊗	⊗	⊗	⊗	⊗	⊗	⊗	⊗	⊗	⊗
	2	Low-Alloyed Steel	220-280	⊗	⊗	⊗	⊗	⊗	⊗	⊗	⊗	⊗	⊗
	3	High-Alloyed Steel	280-380	⊗	⊗	⊗	⊗	⊗	⊗	⊗	⊗	⊗	⊗
M	4	SS - Ferritic / Martensitic	200-330	⊗	⊗	⊗	⊗	⊗	⊗	⊗	⊗	⊗	⊗
	5	SS - Austenitic	200-330	⊗	⊗	⊗	⊗	⊗	⊗	⊗	⊗	⊗	⊗
	6	SS - Austenitic-ferritic (Duplex)	230-260	⊗	⊗	⊗	⊗	⊗	⊗	⊗	⊗	⊗	⊗
K	7	Malleable Cast Iron	130-230	⊗	⊗	⊗	⊗	⊗	⊗	⊗	⊗	⊗	⊗
	8	Grey Cast Iron	180-245	⊗	⊗	⊗	⊗	⊗	⊗	⊗	⊗	⊗	⊗
	9	Nodular Cast iron	160-250	⊗	⊗	⊗	⊗	⊗	⊗	⊗	⊗	⊗	⊗

⊗ Good Conditions
⊗ Average Conditions
⊗ Difficult Conditions

A
MILLING
Overview
Face milling
Hifeed milling
Shoulder milling
Profile milling
Hardmill
Center & Chamfer
Spot face
Spare Parts
Technical Data
End Mills

PLUS 28088

RECOMMENDED CUTTING CONDITIONS | Condições de corte recomendadas | Condiciones de corte recomendables

ISO	PSM	Material	HB (Brinell)	V _c (m/min)			
				← Wear Resistance		Toughness →	
				PH5705	PH5320	PHP920	PH7920
P	1	Unalloyed Steel	125-220	-	-	180-250	180-240
	2	Low-Alloyed Steel	220-280	-	-	160-230	160-220
	3	High-Alloyed Steel	280-380	-	-	140-220	140-210
M	4	SS - Ferritic / Martensitic	200-330	-	-	-	-
	5	SS - Austenitic	200-330	-	-	-	-
	6	SS - Austenitic-ferritic (Duplex)	230-260	-	-	-	-
K	7	Malleable Cast Iron	130-230	160-290	150-280	160-270	160-260
	8	Grey Cast Iron	180-245	170-320	160-320	140-250	140-240
	9	Nodular Cast iron	160-250	140-200	100-190	120-210	120-200

(Note 1) The above table indicates the cutting conditions of 70% of the tool engagement.
 (Note 2) With low workspace clamping rigidity or long overhang of the tool, adjust cutting speed and feed to 70 or 80% of the recommended conditions above.
 (Note 3) Surface finishing is determined by speed/feed used.
 (Note 4) PH5... and PHS... can be used wet or dry. PH7... use only air.

Selection Example:

ISO	PSM	Material	HB (brinell)	V _c (m/min)		Feed f _z (mm/t)
				← Wear Resistance	Toughness →	
				PH5705	PH5740	SNHU 1206... SNKU 1206...
K	7	Malleable cast iron	130-230	160 (180) 290	160 (1900) 260	0,10 (0,25) 0,35
	8	Grey cast iron	180-245	170 (270) 320	140 (180) 240	0,10 (0,25) 0,35
	9	Nodular cast iron	160-250	140 (150) 200	120 (150) 200	0,10 (0,25) 0,35

This example shows the recommended starting cutting conditions, indicated in Bold type.

Vc (m/min)				Feed fz (mm/t)
PH7930	PH5740	PHS740	Toughness → PH7740	SNH(K)U 1206
160-220	-	140-220	140-200	0,10 (0,25) 0,35
140-200	-	120-200	130-180	0,10 (0,25) 0,35
120-190	-	100-190	100-170	0,10 (0,25) 0,35
140-200	-	-	130-180	0,10 (0,25) 0,35
120-160	-	-	110-160	0,10 (0,25) 0,35
100-140	-	-	90-150	0,10 (0,25) 0,35
150-240	160-260	-	140-220	0,10 (0,25) 0,35
140-230	140-240	-	120-210	0,10 (0,25) 0,35
100-190	120-200	-	100-190	0,10 (0,25) 0,35

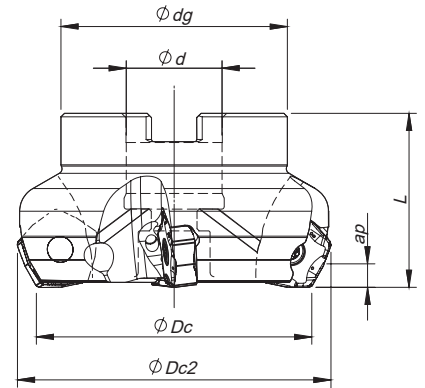
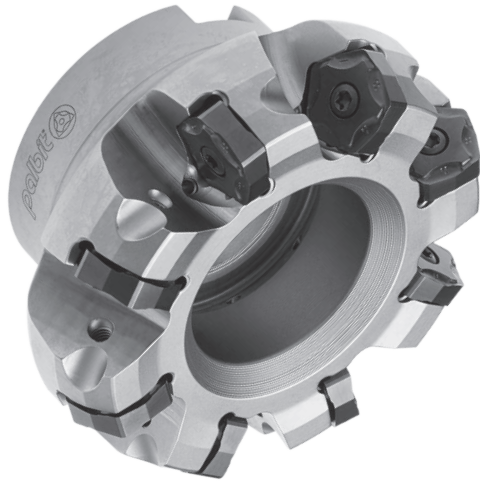

Arbor Mounting
 $K_r=60^\circ$ | $\gamma_p=7^\circ$

Order code Código	Reference Referência Referencia		Dimensions Dimensões Dimensiones (mm)					Kg	Specifications		Insert Pastilha Inserto	Stock
			ϕDc	$\phi Dc2$	ϕd	ϕdg	L		Arbor Type	Ap max (mm)		
181050200	050A90260-05-07-022040	5	50	59,05	22	48	40	0,388	A	5,0	PN... 1105...	
181050300	063A90260-06-07-022040	6	63	72,05	22	52	40	0,597	A	5,0	PN... 1105...	
181050400	080A90260-08-07-027050	8	80	89,05	27	60	50	1,072	B	5,0	PN... 1105...	
181045900	100A90260-10-07-032050	10	100	109,05	32	80	50	1,745	B	5,0	PN... 1105...	
181050500	125A90260-12-07-040063	12	125	134,05	40	90	63	3,047	B	5,0	PN... 1105...	
181050600	160A90260-14-07-U040063	14	160	169,05	40	110	63	4,397	C	5,0	PN... 1105...	

Stock item | Produto de stock | Itens de stock

Available under request (see page A-9) | Disponível sobre consulta (consulte a página A-9) | Disponible bajo consulta (mire pagina A-9)

SPARE PARTS | Complementos | Repuestos

Cutter ϕDc	Order separately				Order separately	
	Insert Screw	Key (Torx)	Key (Torx - Nm)	Torque Value	Screw	DIN 6368 Wrench
A90260 - 50 - 63				3,0	-	-
A90260 - 80				3,0	J0123510	SD6368-12
A90260 - 100				3,0	J0164110	SD6368-16
A90260 - 125				3,0	J0204610	SD6368-20
A90260 - 160				3,0	-	-

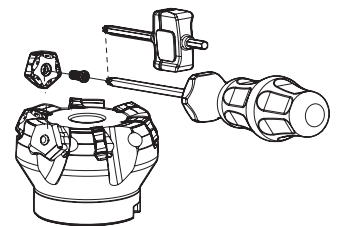

Note: The toolholder is supplied with the XT/PT key. To order the DT key please check the page A-241.
 Check the procedures for the clamping screws on the page A-241.



PNH(K)X 1105 | Inserts | Pastilhas | Plaquetas

PNHX-MK

PNHX-HK

PNKX-MK

PNH(K)X-MK | HK

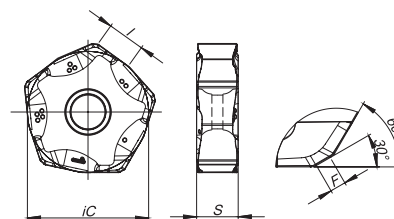
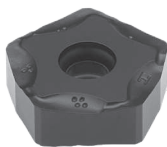
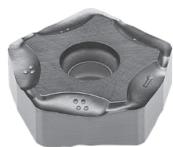

(1) Geometry code	(2) Grade code ISO Reference	P		K				Dimensions Dimensões Dimensiones (mm)				
		PVD		CVD		PVD		iC	S	I	R	F
		G1	G4	L5	L9	G1	G4					
1111374	PNHX 1105 ZNER-MK	☉	☉	☹	☉	☉	☉	16,50	5,66	5,70	-	1,30
1111998	PNHX 1105 ZNER-HK			☹	○			16,50	5,66	5,70	-	1,30
1112294	PNKX 1105 ZNER-MK	☉	☉	☹	○	☉	☉	16,50	5,66	5,70	-	1,30

☉ First choice | Primeira opção | 1ª opción ☉ Stock item | Produto de stock | Itens de stock ○ Available under request (see page A-9) | Disponível sobre consulta (consulte a página A-9) | Disponible bajo consulta (mire página A-9) Insert order code = (1) Geometry Code + (2) Grade Code

GRADES SELECTION GUIDE | Guia para selecção de graus | Tabla para selección de calidades

ISO	PSM	Material	HB (brinell)	Grades				
				← Wear Resistance			Toughness →	
				PH5705	PH7910	PH7920	PH5740	PH7740
P	1	Unalloyed Steel	125-220		☉	☉		☉
	2	Low-Alloyed Steel	220-280		☉	☉		☉
	3	High-Alloyed Steel	280-380		☉	☉		☉
K	7	Malleable Cast Iron	130-230	☉	☉	☉	☉	
	8	Grey Cast Iron	180-245	☉	☉	☉	☉	
	9	Nodular Cast iron	160-250	☉	☉	☉	☉	

☉ Good Conditions
☉ Average Conditions
☉ Difficult Conditions

PLUS 90260

RECOMMENDED CUTTING CONDITIONS | Condições de corte recomendadas | Condiciones de corte recomendables

ISO	PSM	Material	HB (Brinell)	Vc (m/min)		
				← Wear Resistance		
				PH5705	PH7910	PH7920
P	1	Unalloyed Steel	125-220	-	180-250	180-240
	2	Low-Alloyed Steel	220-280	-	160-230	160-220
	3	High-Alloyed Steel	280-380	-	140-220	140-210
K	7	Malleable Cast Iron	130-230	160-290	180-300	160-260
	8	Grey Cast Iron	180-245	170-320	160-250	140-240
	9	Nodular Cast iron	160-250	140-200	150-200	120-200

(Note 1) Cutting conditions $a_e/DC=70\%$.

(Note 2) Cutting conditions should be adjusted according to the machine and work rigidity.

(Note 3) If chattering occurs, reduce a_p and V_c by 30% and keep the same f_z per tooth.

CHIP-BREAKER SELECTION GUIDE | Guia para aplicações do quebra- aparas | Guía para aplicación del rompevirutas

ISO	PSM	Material	HB (Brinell)	Chip-Breaker Application	
				1st choice	Difficult Operations
P	1	Unalloyed Steel	125-220	PNH(K)X 11... MK	-
	2	Low-Alloyed Steel	220-280	PNH(K)X 11... MK	-
	3	High-Alloyed Steel	280-380	PNH(K)X 11... MK	-
K	7	Malleable Cast Iron	130-230	PNH(K)X 11... MK	PNH(K)X 11... HK
	8	Grey Cast Iron	180-245	PNH(K)X 11... MK	PNH(K)X 11... HK
	9	Nodular Cast iron	160-250	PNH(K)X 11... MK	PNH(K)X 11... HK

Vc (m/min)	Toughness →	Feed fz (mm/t)
PH5740		PNH(K)X 1105...
-		0,15-0,30
-		0,15-0,30
-		0,15-0,25
160-260		0,12-0,35
140-240		0,12-0,35
120-200		0,12-0,30

A

MILLING

Overview

Face milling

Hifeed milling

Shoulder milling

Profile milling

Hardmill

Center & Chamfer

Spotface

Spare Parts

Technical Data

End Mills

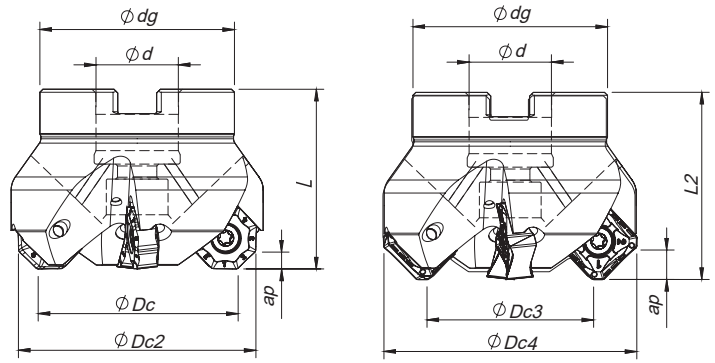

Arbor Mounting

$K_r=45^\circ$ | $\gamma_p=-6^\circ$

Order code Código	Reference Referência Referencia		Dimensions Dimensões Dimensiones (mm)							Kg	Specifications		Insert Pastilha Inserto	Stock	
			ϕDc	$\phi Dc2$	$\phi Dc3$	$\phi Dc4$	ϕd	ϕdg	L		L2	Arbor Type			Ap (mm)
181111400	050A90845-04-06-022040	4	50	57,6	47,1	62	22	48	40	41,5	0,383	A	3,5 6,0	ON...05 SN...12	
181117400	050A90845-06-06-022040	6	50	57,6	47,1	62	22	48	40	41,5	0,374	A	3,5 6,0	ON...05 SN...12	
181117500	063A90845-06-06-022040	6	63	70,6	60,1	75	22	52	40	41,5	0,525	A	3,5 6,0	ON...05 SN...12	
181117600	063A90845-08-06-022040	8	63	13,6	60,1	75	22	52	40	41,5	0,517	A	3,5 6,0	ON...05 SN...12	
181117700	080A90845-07-06-027050	7	80	87,6	77,1	92	27	60	50	51,5	0,846	B	3,5 6,0	ON...05 SN...12	
181117800	080A90845-10-06-027050	10	80	87,6	77,1	92	27	60	50	51,5	0,842	B	3,5 6,0	ON...05 SN...12	
181117900	100A90845-08-06-032050	8	100	107,6	97,1	112	32	80	50	51,5	1,559	B	3,5 6,0	ON...05 SN...12	
181120900	100A90845-12-06-032050	12	100	107,6	97,1	112	32	80	50	51,5	1,540	B	3,5 6,0	ON...05 SN...12	
181121000	125A90845-10-06-040063	10	125	132,6	122,1	137	40	90	63	64,5	2,890	B	3,5 6,0	ON...05 SN...12	
181121100	160A90845-12-06-U040063	12	160	167,6	157,1	172	40	110	63	64,5	4,360	C	3,5 6,0	ON...05 SN...12	
181121200	200A90845-14-06-U060063	14	200	207,6	197,1	212	60	172	63	64,5	8,890	C	3,5 6,0	ON...05 SN...12	
181121300	250A90845-16-06-U060063	16	250	257,6	247,1	262	60	172	63	64,5	11,490	C	3,5 6,0	ON...05 SN...12	

Stock item | Produto de stock | Itens de stock

Available under request (see page A-9) | Disponível sobre consulta (consulte a página A-9) | Disponible bajo consulta (mire pagina A-9)

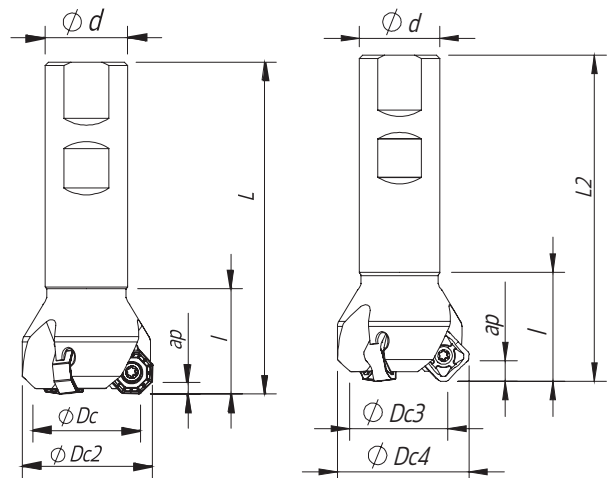

Weldon Shank

$K_r=45^\circ$ | $\gamma_p=-6^\circ$

Order code Código	Reference Referência Referencia		Dimensions Dimensões Dimensiones (mm)							Kg	Specifications		Insert Pastilha Inserto	Stock
			ϕDc	$\phi Dc2$	$\phi Dc3$	$\phi Dc4$	ϕd	L	L2		Ap (mm)			
181118000	032W90845-03-06-025100	3	32	39,6	29,1	44	25	100	101,5	0,375	3,5 6,0	ON...05 SN...12		
181118100	040W90845-04-06-032110	4	40	47,6	37,1	52	32	110	111,5	0,653	3,5 6,0	ON...05 SN...12		

Stock item | Produto de stock | Itens de stock

Available under request (see page A-9) | Disponível sobre consulta (consulte a página A-9) | Disponible bajo consulta (mire pagina A-9)

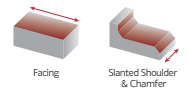

ONH(K)X 05 | SNH(K)X 12 | Inserts | Pastilhas | Plaquetas

A

MILLING

Overview

Face milling

Hifeed milling

Shoulder milling

Profile milling

Hardmill

Center & Chamfer

Spot face

Spare Parts

Technical Data

End Mills

ONH(K)X-MP
(PHP grade)



ONH(K)X-MK



ONH(K)X-LP | MP | MK

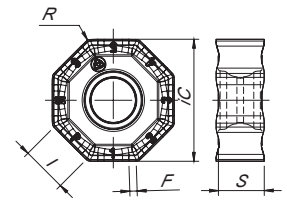

ONHX-W
8 Cutting Edges (8R)



SNHX-W
4 Cutting edges (2R + 2L)



ONHX-W

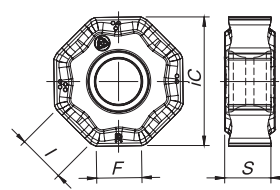

SNHX-W

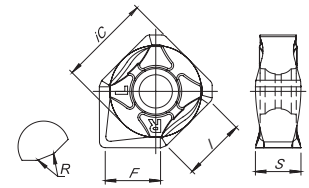

SNH(K)X-LP



SNH(K)X-MP
(PHP grade)

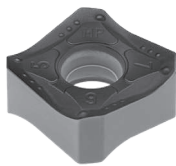

SNH(K)X-MK

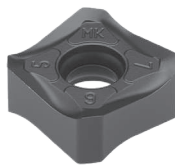

SNHX-LN

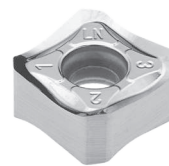

SNH(K)X-LP | MP | MK | LN

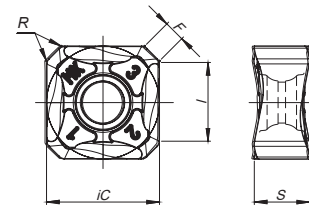

Geometry code	ISO Reference	Material																		Dimensions						
		P						M		K						N		S		Dimensions						
		CVD						PVD		CVD			PVD			UNC		PVD		Dimensions (mm)						
(2) Grade code	T9	X5	G4	T1	P3	P4	G6	X9	G6	L5	L6	L9	X5	G4	T1	P3	P4	G6	10	X9	G6	iC	S	I	R	F
1112302	ONHX 050505 ANEN-LP				⊗		⊗		⊗						⊗		⊗	⊗			⊗	12,70	5,20	5,30	0,50	-
1112304	ONHX 050505 ANSN-MP				⊗		⊗								⊗		⊗					12,70	5,20	5,30	0,50	-
1112301	ONKX 050505 ANEN-LP			⊗	⊗	⊗		⊗							⊗	⊗	⊗				⊗	12,70	5,20	5,30	0,50	-
1112303	ONKX 050505 ANSN-MP	⊗		⊗	⊗	⊗									⊗	⊗	⊗					12,70	5,20	5,30	0,50	-
1112305	ONKX 050500 ANEN-MK														⊗	⊗						12,70	5,20	5,30	-	-
1112307	ONHX 050500 ANER-W			⊗											⊗							12,70	5,20	5,30	-	4,30
1111452	SNHX 1206 ANEN-LP				⊗		⊗		⊗							⊗		⊗			⊗	12,70	6,35	9,30	0,80	2,00
1111502	SNHX 1206 ANSN-MP	⊗	⊗	⊗	⊗		⊗								⊗	⊗	⊗					12,70	6,35	9,30	0,80	2,00
1111503	SNHX 1206 ANEN-MK														⊗		⊗	⊗				12,70	6,35	9,30	0,80	2,00
1111504	SNHX 1206 ANFN-LN																				⊗	12,70	6,35	9,30	0,80	2,00
1111899	SNHX 1206 ANFN-W*		⊗		⊗										⊗	⊗						12,70	6,30	9,30	0,40	7,60
1112293	SNKX 1206 ANSN-MP	⊗		⊗	⊗		⊗								⊗	⊗				⊗		12,70	6,35	9,30	0,80	2,00
1112249	SNKX 1206 ANEN-MK														⊗	⊗	⊗					12,70	6,35	9,30	0,80	2,00

⊗ First choice | Primeira opção | 1ª opción ⊗ Stock item | Produto de stock | Itens de stock ○ Available under request (see page A-9) | Disponível sobre consulta (consulte a página A-9) | Disponible bajo consulta (mire página A-9) Insert order code = (1) Geometry Code + (2) Grade Code

* Wiper insert with 2 rights and 2 left-hand cutting edges.

PLUS 90845

SPARE PARTS | Complementos | Repuestos

Cutter ØDc	Insert Screw	Key (Torx)	Order separately		Order separately	
			Key (Torx - Nm)	Torque Value	Screw	DIN 6368 Wrench
A90845 - 50 - 63	P0401200	XT15	DT1530	3,0	-	-
A90845 - 80	P0401200	XT15	DT1530	3,0	J0123510	SD6368-12
A90845 - 100	P0401200	PT15	DT1530	3,0	J0164110	SD6368-16
A90845 - 125	P0401200	PT15	DT1530	3,0	J0204610	SD6368-20
A90845 - 160 - 250	P0401200	PT15	DT1530	3,0	-	-
W90845 - 32 - 40	P0401200	XT15	DT1530	3,0	-	-

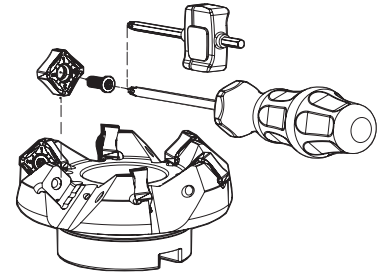

Note: The toolholder is supplied with the XT/PT key. To order the DT key please check the page A-241.
Check the procedures for the clamping screws on the page A-241.

GRADES SELECTION GUIDE | Guia para selecção de graus | Tabla para selección de calidades

ISO	PSM	Material	HB (Brinell)	Grades											
				← Wear Resistance								Toughness →			
				PH0910	PH5705	PH5320	PHP910	PHP920	PH7920	PHP930	PHH930	PH7930	PH5740	PHS740	PH7740
P	1	Unalloyed Steel	125-220				✓	✓	✓	✓		✓	✓		
	2	Low-Alloyed Steel	220-280				✓	✓	✓	✓		✓	✓		
	3	High-Alloyed Steel	280-380				✓	✓	✓	✓		✓	✓		
M	4	SS - Ferritic / Martensitic	200-330								✓	✓	✓		
	5	SS - Austenitic	200-330								✓	✓	✓		
	6	SS - Austenitic-ferritic (Duplex)	230-260								✓	✓	✓		
K	7	Malleable Cast Iron	130-230		✓	✓	✓	✓	✓	✓		✓	✓		
	8	Grey Cast Iron	180-245		✓	✓	✓	✓	✓	✓		✓	✓		
	9	Nodular Cast iron	160-250		✓	✓	✓	✓	✓	✓		✓	✓		
N	10	Aluminium and Non Ferrous	30-130	✓											
S	11	Heat Resistant Super Alloys	200-320								✓	✓	✓		

● Good Conditions

● Average Conditions

● Difficult Conditions

RECOMMENDED CUTTING CONDITIONS | Condições de corte recomendadas | Condiciones de corte recomendables

ISO	PSM	Material	HB (Brinell)	Vc (m/min)						
				← Wear Resistance				Toughness →		
				PH0910	PH5705	PH5320	PHP910	PHP920	PH7920	PHP930
P	1	Unalloyed Steel	125-220	-	-	-	180-250	180-250	180-240	160-220
	2	Low-Alloyed Steel	220-280	-	-	-	160-240	160-230	160-220	140-200
	3	High-Alloyed Steel	280-380	-	-	-	140-230	140-220	140-210	120-190
M	4	SS - Ferritic / Martensitic	200-330	-	-	-	-	-	140-220	140-200
	5	SS - Austenitic	200-330	-	-	-	-	-	130-180	120-160
	6	SS - Austenitic-ferritic (Duplex)	230-260	-	-	-	-	-	120-160	100-140
K	7	Malleable Cast Iron	130-230	-	160-290	150-280	180-300	160-270	160-260	150-240
	8	Grey Cast Iron	180-245	-	170-320	160-320	160-250	140-250	140-240	140-230
	9	Nodular Cast iron	160-250	-	140-200	100-190	150-210	120-210	120-200	100-190
N	10	Aluminium and Non Ferrous	30-130	100-2000	-	-	-	-	-	-
S	11	Heat Resistant Super Alloys	200-320	-	-	-	-	-	-	30-100

ISO	PSM	Material	HB (Brinell)	Vc (m/min)					Feed fz (mm/t)	
				← Wear Resistance			Toughness →		SNH(K)X 12...	ONH(K)X 05...
				PHH930	PH7930	PH5740	PH5740	PH7740		
P	1	Unalloyed Steel	125-220	-	160-220	-	140-220	140-200	0,10-0,35	0,10-0,35
	2	Low-Alloyed Steel	220-280	-	140-200	-	120-200	130-180	0,10-0,35	0,10-0,35
	3	High-Alloyed Steel	280-380	-	120-190	-	100-190	100-170	0,10-0,30	0,10-0,30
M	4	SS - Ferritic / Martensitic	200-330	140-210	140-200	-	-	130-180	0,10-0,30	0,10-0,30
	5	SS - Austenitic	200-330	120-170	120-160	-	-	110-160	0,10-0,30	0,10-0,30
	6	SS - Austenitic-ferritic (Duplex)	230-260	100-150	100-140	-	-	90-150	0,10-0,25	0,10-0,25
K	7	Malleable Cast Iron	130-230	-	150-240	160-260	-	140-220	0,10-0,35	0,10-0,35
	8	Grey Cast Iron	180-245	-	140-230	140-240	-	120-210	0,10-0,35	0,10-0,35
	9	Nodular Cast iron	160-250	-	100-190	120-200	-	100-190	0,10-0,30	0,10-0,30
N	10	Aluminium and Non Ferrous	30-130	-	-	-	-	0,10-0,35	-	
S	11	Heat Resistant Super Alloys	200-320	30-110	30-100	-	-	30-100	0,07-0,20	0,07-0,18

(Note 1) Cutting conditions $a_e/D_c=70\%$.

(Note 2) It's possible to occur vibrations in certain cases. Please reduce depth of cut and / or reduce cutting conditions in following cases:

- When using long shank;
- When using long tool overhang with arbor type;
- When application has poor clamping rigidity or when using a low rigidity machine.

(Note 3) PH5... and PHS... can be used wet or dry. PH7... use only air.

CHIP-BREAKER SELECTION GUIDE | Guia para aplicações do quebra- aparas | Guía para aplicación del rompevirutas

ISO	PSM	Material	HB (Brinell)	Chip-Breaker Application	
				1st choice	Difficult Operations
P	1	Unalloyed Steel	125-220	LP	MP
	2	Low-Alloyed Steel	220-280	LP	MP
	3	High-Alloyed Steel	280-380	MP	-
M	4	SS - Ferritic / Martensitic	200-330	LP	MP
	5	SS - Austenitic	200-330	LP	-
	6	SS - Austenitic-ferritic (Duplex)	230-260	LP	-
K	7	Malleable Cast Iron	130-230	MK	-
	8	Grey Cast Iron	180-245	MK	-
	9	Nodular Cast iron	160-250	MK	-
N	10	Aluminium and Non Ferrous	30-130	LN	-
S	11	Heat Resistant Super Alloys	200-320	LP	-

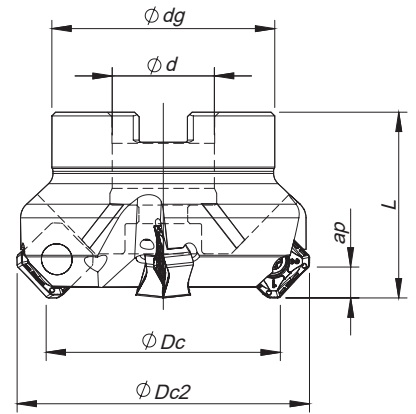

Arbor Mounting

$K_r=45^\circ$ | $\gamma_p=-6^\circ$

Order code Código	Reference Referência Referencia		Dimensions Dimensões Dimensiones (mm)					Kg	Specifications		Insert Pastilha Inserto	Stock
			ϕDc	$\phi Dc2$	ϕd	ϕdg	L		Arbor Type	A_p max (mm)		
181048200	050A90945-04-06-022040	4	50	63	22	48	40	0,424	A	6,0	SN... 1206	
181067000	050A90945-06-06-022040	6	50	63	22	48	40	0,415	A	6,0	SN... 1206	
181048300	063A90945-06-06-022040	6	63	76	22	52	40	0,575	A	6,0	SN... 1206	
181067100	063A90945-08-06-022040	8	63	76	22	52	40	0,577	A	6,0	SN... 1206	
181048400	080A90945-07-06-027050	7	80	93	27	60	50	0,966	B	6,0	SN... 1206	
181067200	080A90945-10-06-027050	10	80	93	27	60	50	0,950	B	6,0	SN... 1206	
181048500	100A90945-08-06-032050	8	100	113	32	80	50	1,667	B	6,0	SN... 1206	
181067300	100A90945-12-06-032050	12	100	113	32	80	50	1,650	B	6,0	SN... 1206	
181048600	125A90945-10-06-040063	10	125	138	40	90	63	2,890	B	6,0	SN... 1206	
181048700	160A90945-12-06-U040063	12	160	173	40	110	63	4,360	C	6,0	SN... 1206	
181052800	200A90945-14-06-U060063	14	200	213	60	172	63	8,890	C	6,0	SN... 1206	
181064700	250A90945-16-06-U060063	16	250	263	60	172	63	11,490	C	6,0	SN... 1206	

Stock item | Produto de stock | Itens de stock

Available under request (see page A-9) | Disponível sobre consulta (consulte a página A-9) | Disponible bajo consulta (mire página A-9)

SPARE PARTS | Complementos | Repuestos

Cutter ϕDc	Insert Screw	Key (Torx)	Order separately		Order separately	
			Key (Torx - Nm)	Torque Value	Screw	DIN 6368 Wrench
A90945 - 50 - 63	P0401200	XT15	DT1530	3,0	-	-
A90945 - 80	P0401200	XT15	DT1530	3,0	J0123510	SD6368-12
A90945 - 100	P0401200	PT15	DT1530	3,0	J0164110	SD6368-16
A90945 - 125	P0401200	PT15	DT1530	3,0	J0204610	SD6368-20
A90945 - 160 - 250	P0401200	PT15	DT1530	3,0	-	-

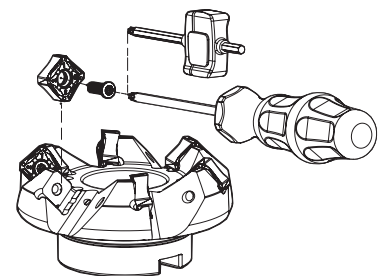

Note: The toolholder is supplied with the XT/PT key. To order the DT key please check the page A-241.
Check the procedures for the clamping screws on the page A-241.

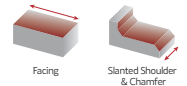

SNH(K)X 1206 | Inserts | Pastilhas | Plaquetas

A

MILLING

Overview

Face milling

Hifeed milling

Shoulder milling

Profile milling

Hardmill

Center & Chamfer

Spot face

Spare Parts

Technical Data

End Mills

SNH(K)X-LP



SNH(K)X-MP

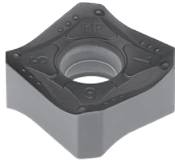

SNH(K)X-LP | MP | MK | LN

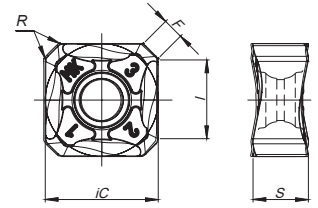

SNH(K)X-MK

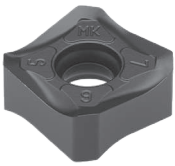

SNHX-LN



SNHX-W

4 Cutting edges (2R + 2L)



SNHX-W

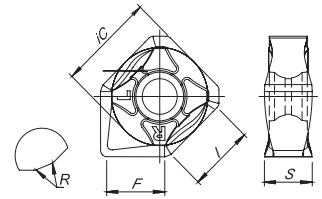

(1) Geometry code	(2) Grade code ISO Reference	P						M	K						N	S	Dimensions Dimensões Dimensiones (mm)					
		CVD		PVD				PVD	CVD			PVD			UNC	PVD						
		T9	X5	G4	T1	P4	G6	X9	L5	L6	L9	X5	G4	T1	P4	G6	10	X9	iC	S	I	R
1112293	SNKX 1206 ANSN-MP	⊗		⊗	⊗		⊗					⊗	⊗		⊗			12,70	6,35	9,30	0,80	2,00
1112249	SNKX 1206 ANEN-MK							⊗	⊗	⊗								12,70	6,35	9,30	0,80	2,00
1111452	SNHX 1206 ANEN-LP				⊗	⊗		⊗						⊗	⊗		⊗	12,70	6,35	9,30	0,80	2,00
1111502	SNHX 1206 ANSN-MP	⊗	⊗	⊗	⊗	⊗					⊗	⊗	⊗	⊗				12,70	6,35	9,30	0,80	2,00
1111503	SNHX 1206 ANEN-MK		⊗	⊗	⊗			⊗		⊗	⊗	⊗	⊗					12,70	6,35	9,30	0,80	2,00
1111504	SNHX 1206 ANFN-LN															⊗		12,70	6,35	9,30	0,80	2,00
1111899	SNHX 1206 ANFN-W*		⊗		⊗						⊗		⊗					12,70	6,30	9,30	0,40	7,60

⊗ First choice | Primeira opção | 1ª opción ⊗ Stock item | Produto de stock | Itens de stock ○ Available under request (see page A-9) | Disponível sobre consulta (consulte a página A-9) | Disponible bajo consulta (mire página A-9) Insert order code = (1) Geometry Code + (2) Grade Code

* Wiper insert with 2 rights and 2 left-hand cutting edges.

PLUS 90945

RECOMMENDED CUTTING CONDITIONS | Condições de corte recomendadas | Condiciones de corte recomendables

ISO	PSM	Material	HB (Brinell)	Vc (m/min)						
				← Wear Resistance						
				PH0910	PH5705	PH5320	PHP910	PHP920	PH7920	PHP930
P	1	Unalloyed Steel	125-220	-	-	-	180-250	180-250	180-240	160-220
	2	Low-Alloyed Steel	220-280	-	-	-	160-240	160-230	160-220	140-200
	3	High-Alloyed Steel	280-380	-	-	-	140-230	140-220	140-210	120-190
M	4	SS - Ferritic / Martensitic	200-330	-	-	-	-	-	140-220	140-200
	5	SS - Austenitic	200-330	-	-	-	-	-	130-180	120-160
	6	SS - Austenitic-ferritic (Duplex)	230-260	-	-	-	-	-	120-160	100-140
K	7	Malleable Cast Iron	130-230	-	160-290	150-280	180-300	160-270	160-260	150-240
	8	Grey Cast Iron	180-245	-	170-320	160-320	160-250	140-250	140-240	140-230
	9	Nodular Cast iron	160-250	-	140-200	100-190	150-210	120-210	120-200	100-190
N	10	Aluminium and Non Ferrous	30-130	100-2000	-	-	-	-	-	-
S	11	Heat Resistant Super Alloys	200-320	-	-	-	-	-	-	30-100

(Note 1) Cutting conditions $a_e/D_c=70\%$.

(Note 2) It's possible to occur vibrations in certain cases. Please reduce depth of cut and / or reduce cutting conditions in following cases:

- When using long shank;
- When using long tool overhang with arbor type;
- When application has poor clamping rigidity or when using a low rigidity machine.

(Note 3) PH5... and PH5... can be used wet or dry. PH7... use only air.

GRADES SELECTION GUIDE | Guia para selecção de graus | Tabla para selección de calidades

ISO	PSM	Material	HB (Brinell)	Grades											
				← Wear Resistance							Toughness →				
				PH0910	PH5705	PH5320	PHP910	PHP920	PH7920	PHP930	PHH930	PH7930	PH5740	PHS740	PH7740
P	1	Unalloyed Steel	125-220				✓	✓	✓	✓		✓		✓	✓
	2	Low-Alloyed Steel	220-280				✓	✓	✓	✓		✓		✓	✓
	3	High-Alloyed Steel	280-380				✓	✓	✓	✓		✓		✓	✓
M	4	SS - Ferritic / Martensitic	200-330								✓	✓			✓
	5	SS - Austenitic	200-330								✓	✓			✓
	6	SS - Austenitic-ferritic (Duplex)	230-260								✓	✓			✓
K	7	Malleable Cast Iron	130-230		✓	✓	✓	✓	✓	✓		✓	✓		✓
	8	Grey Cast Iron	180-245		✓	✓	✓	✓	✓	✓		✓	✓		✓
	9	Nodular Cast iron	160-250		✓	✓	✓	✓	✓	✓		✓	✓		✓
N	10	Aluminium and Non Ferrous	30-130	✓											
S	11	Heat Resistant Super Alloys	200-320								✓	✓			✓

● Good Conditions

● Average Conditions

● Difficult Conditions

CHIP-BREAKER SELECTION GUIDE | Guia para aplicações do quebra- aparas | Guía para aplicación del rompevirutas

ISO	PSM	Material	HB (Brinell)	Chip-Breaker Application	
				1st choice	Difficult Operations
P	1	Unalloyed Steel	125-220	SNHX 12... LP	SNH(K)X 12... MP
	2	Low-Alloyed Steel	220-280	SNHX 12... LP	SNH(K)X 12... MP
	3	High-Alloyed Steel	280-380	SNH(K)X 12... MP	-
M	4	SS - Ferritic / Martensitic	200-330	SNHX 12... LP	-
	5	SS - Austenitic	200-330	SNHX 12... LP	-
	6	SS - Austenitic-ferritic (Duplex)	230-260	SNHX 12... LP	-
K	7	Malleable Cast Iron	130-230	SNH(K)X 12... MK	-
	8	Grey Cast Iron	180-245	SNH(K)X 12... MK	-
	9	Nodular Cast iron	160-250	SNH(K)X 12... MK	-
N	10	Aluminium and Non Ferrous	30-130	SNHX 12... LN	-
S	11	Heat Resistant Super Alloys	200-320	SNHX 12... LP	-

Vc (m/min)					Feed fz (mm/t)				
Toughness →									
PHH930	PH7930	PH5740	PHS740	PH7740	SNHX 12... LP	SNH(K)X 12... MP	SNH(K)X 12... MK	SNHX 12... LN	SNHX 12... W
-	160-220	-	140-220	140-200	0,10-0,35	0,10-0,35	-	-	0,10-0,35
-	140-200	-	120-200	130-180	0,10-0,35	0,10-0,35	-	-	0,10-0,35
-	120-190	-	100-190	100-170	0,10-0,30	0,10-0,30	-	-	0,10-0,30
140-210	140-200	-	-	130-180	0,10-0,30	-	-	-	-
120-170	120-160	-	-	110-160	0,10-0,30	-	-	-	-
100-150	100-140	-	-	90-150	0,10-0,25	-	-	-	-
-	150-240	160-260	-	140-220	0,10-0,35	-	0,10-0,35	-	0,10-0,40
-	140-230	140-240	-	120-210	0,10-0,35	-	0,10-0,35	-	0,10-0,40
-	100-190	120-200	-	100-190	0,10-0,30	-	0,10-0,30	-	0,10-0,40
-	-	-	-	-	-	-	-	0,10-0,35	-
30-110	30-100	-	-	30-100	0,07-0,20	-	-	-	-

WIPER INSERTS

Recommended Cutting Conditions:

- f_z should be equal to $0,8 \times F_w / Z$
- Axial depth of cut is 0,5 to 0,8mm.

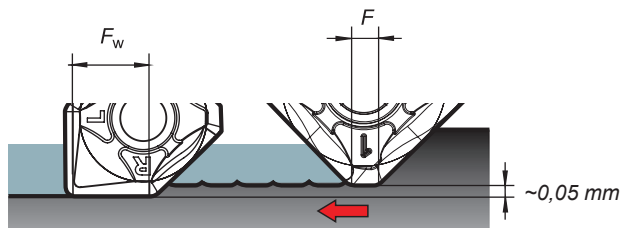

Example:

- The width of the parallel land (F) of the insert is 2mm.
- To obtain a good surface finishing, the feed per revolution should be a maximum of 80% of 2mm = 1,6mm.
- The wiper insert will have a parallel land (F_w) with a width of 7,6mm.
- Result: Feed per revolution (f_r) could be increased from 1,6mm to 6,1mm (80% of 7,6mm).

Note: Other limitations, such as machine power, must be taken into consideration.

How to use a wiper insert:

- Since wiper is one corner use to standard cutters, please attach the insert with the parallel land down to the workspace cutting surface.

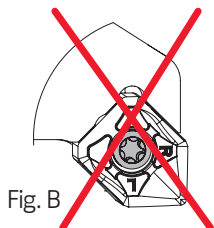
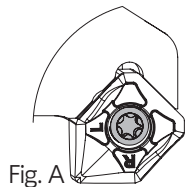

When using wiper insert, install the insert as shown on Fig. A if the insert is installed as shown on Fig. B breakage of the insert is inevitable and normal surface finish can not be obtained.

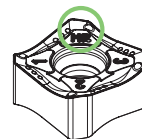

This point shows the SNKX insert difference to SNHX



Put the same side of insert in each pocket for best radial and axial runout when using SNKX.

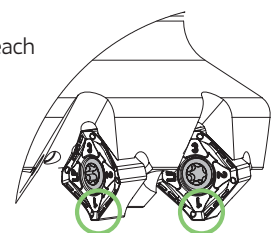

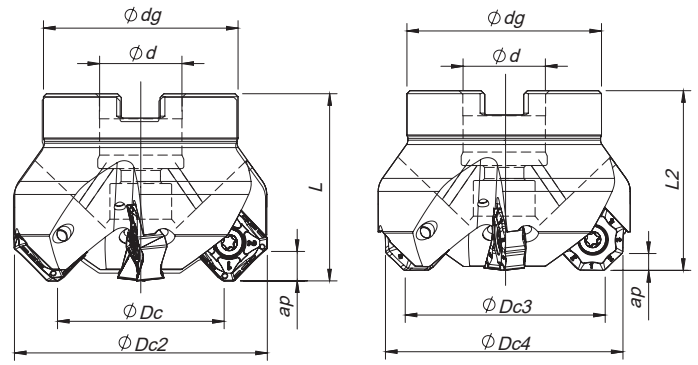
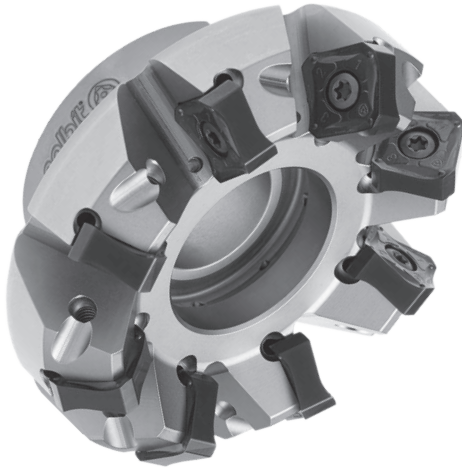

Arbor Mounting
 $K_r = 45^\circ$ | $\gamma_p = -6^\circ$

Order code Código	Reference Referência Referencia		Dimensions Dimensões Dimensiones (mm)								Kg	Specifications		Insert Pastilha Inserto	Stock
			ϕDc	$\phi Dc2$	$\phi Dc3$	$\phi Dc4$	ϕd	ϕdg	L	L2		Arbor Type	Ap (mm)		
181088900	063A91245-05-06-022050	5	63	80,1	66,6	76,0	22	52	50	48	0,81	A	3,8 8,5	ON...06 SN...16	
181089000	080A91245-06-06-027050	6	80	97,1	83,6	93,0	27	60	50	48	1,06	B	3,8 8,5	ON...06 SN...16	
181089100	080A91245-08-06-027050	8	80	97,1	83,6	93,0	27	60	50	48	1,09	B	3,8 8,5	ON...06 SN...16	
181089200	100A91245-07-06-032063	7	100	117,1	103,6	113,0	32	80	63	61	2,24	B	3,8 8,5	ON...06 SN...16	
181089300	100A91245-10-06-032063	10	100	117,1	103,6	113,0	32	80	63	61	2,28	B	3,8 8,5	ON...06 SN...16	
181089400	125A91245-08-06-040063	8	125	142,1	128,6	138,0	40	90	63	61	3,04	B	3,8 8,5	ON...06 SN...16	
181089500	160A91245-10-06-U040063	10	160	177,1	163,6	173,0	40	110	63	61	4,40	C	3,8 8,5	ON...06 SN...16	
181089600	200A91245-12-06-U060063	12	200	217,1	203,6	213,0	60	172	63	61	9,12	C	3,8 8,5	ON...06 SN...16	
181089700	250A91245-14-06-U060063	14	250	267,1	253,6	263,0	60	172	63	61	11,93	C	3,8 8,5	ON...06 SN...16	

Stock item | Produto de stock | Itens de stock

Available under request (see page A-9) | Disponível sobre consulta (consulte a página A-9) | Disponible bajo consulta (mire pagina A-9)

SPARE PARTS | Complementos | Repuestos

Cutter ϕDc	Insert Screw	Key (Torx)	Order separately		Order separately	
			Key (Torx - Nm)	Torque Value	Screw	DIN 6368 Wrench
A91245 - 63	P0451400	XT20	DT2050	5,0	-	-
A91245 - 80	P0451400	XT20	DT2050	5,0	J0123510	SD6368-12
A91245 -100	P0451400	PT20	DT2050	5,0	J0164110	SD6368-16
A91245 -125	P0451400	PT20	DT2050	5,0	J0204610	SD6368-20
A91245 - 160-250	P0451400	PT20	DT2050	5,0	-	-

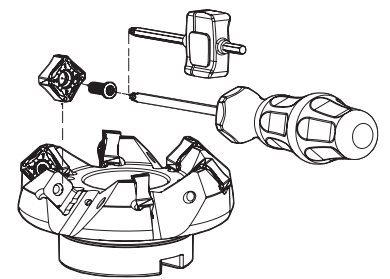

Note: The toolholder is supplied with the XT/PT key. To order the DT key please check the page A-241.
 Check the procedures for the clamping screws on the page A-241.

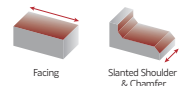

ONH(K)X 0606 | SNH(K)X 1606 | Inserts | Pastilhas | Plaquetas

A
MILLING
Overview
Face milling
Hifed milling
Shoulder milling
Profile milling
Hardmill
Center & Chamfer
Spotface
Spare Parts
Technical Data
End Mills

ONH(K)X-LP



ONH(K)X-MP
(PHP grade)



ONH(K)X-MK



ONH(K)X-LP | MP | MK

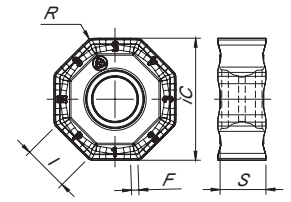

ONHX-W
(8 Cutting edges (4R + 4L))



ONHX-LS
(PHH grade) **NEW**



ONHX-W

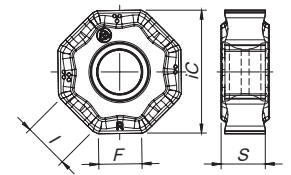

SNH(K)X-LP



SNH(K)X-MP
(PHS grade)

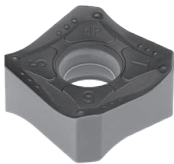

SNH(K)X-MK

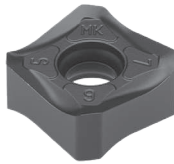

SNH(K)X-LP | MP | MK

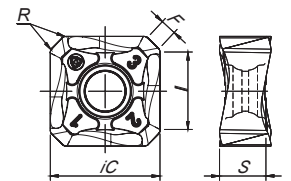

(1) Geometry code	(2) Grade code ISO Reference	P						M			K						S			Dimensions Dimensões Dimensiones (mm)						
		CVD		PVD				PVD			CVD		PVD				PVD			iC	S	I	R	F		
		T9	G4	T1	P3	P4	G6	P3	X9	G6	L5	L6	L9	G4	T1	P3	P4	G6	P3						X9	G6
1111954	ONHX 0606 ANEN-LP			⊗		⊗	⊗															16,50	6,35	6,20	0,80	1,00
1112696	ONHX 0606 ANEN-LS								⊗													16,50	6,35	6,20	0,80	1,00
1111955	ONHX 0606 ANEN-MP			⊗			⊗								⊗							16,50	6,35	6,20	0,80	1,00
1111956	ONHX 0606 ANEN-MK											⊗		⊗								16,50	6,35	6,20	0,80	1,00
1112053	ONHX 0606 ANEN-W*		⊗									⊗			⊗							16,50	6,35	6,20	-	6,00
1112284	ONKX 0606 ANEN-LP		⊗	⊗	⊗		⊗	⊗				⊗		⊗	⊗	⊗		⊗	⊗			16,50	6,35	6,20	0,80	1,00
1112287	ONKX 0606 ANEN-MP	⊗	⊗	⊗			⊗							⊗	⊗		⊗					16,50	6,35	6,20	0,80	1,00
1112291	ONKX 0606 ANEN-MK											⊗										16,50	6,35	6,20	0,80	1,00
1111951	SNHX 1606 ANER-LP		⊗	⊗		⊗	⊗			⊗				⊗	⊗		⊗					16,50	6,35	12,50	0,80	2,20
1111952	SNHX 1606 ANER-MP	⊗		⊗			⊗									⊗		⊗				16,50	6,35	12,50	0,80	2,20
1111953	SNHX 1606 ANER-MK												⊗									16,50	6,35	12,50	0,80	2,20
1112281	SNKX 1606 ANER-MP	⊗	⊗	⊗			⊗							⊗	⊗		⊗					16,50	6,35	12,50	0,80	2,20
1112282	SNKX 1606 ANER-MK													⊗	⊗							16,50	6,35	12,50	0,80	2,20

⊗ First choice | Primeira opção | 1ª opción ⊗ Stock item | Produto de stock | Itens de stock ○ Available under request (see page A-9) | Disponível sobre consulta (consulte a página A-9) | Disponible bajo consulta (mire página A-9) Insert order code = (1) Geometry Code + (2) Grade Code

* Wiper insert with 4 rights and 4 left-hand cutting edges.

GRADES SELECTION GUIDE | Guia para selecção de graus | Tabla para selección de calidades

ISO	PSM	Material	HB (Brinell)	Grades									
				← Wear Resistance					Toughness →				
				PH5705	PH5320	PHP920	PH7920	PHP930	PHH930	PH7930	PH5740	PHS740	PH7740
P	1	Unalloyed Steel	125-220	●	●	●	●	●	●	●	●	●	●
	2	Low-Alloyed Steel	220-280			●	●	●		●		●	●
	3	High-Alloyed Steel	280-380			●	●	●		●		●	●
M	4	SS - Ferritic / Martensitic	200-330							●	●		●
	5	SS - Austenitic	200-330							●	●		●
	6	SS - Austenitic-ferritic (Duplex)	230-260							●	●		●
K	7	Malleable Cast Iron	130-230	●	●	●	●	●		●	●		●
	8	Grey Cast Iron	180-245	●	●	●	●	●		●	●		●
	9	Nodular Cast iron	160-250	●	●	●	●	●		●	●		●
S	11	Heat Resistant Super Alloys	200-320							●	●		●

● Good Conditions

● Average Conditions

● Difficult Conditions

RECOMMENDED CUTTING CONDITIONS | Condições de corte recomendadas | Condiciones de corte recomendables

ISO	PSM	Material	HB (Brinell)	Vc (m/min)					
				← Wear Resistance			Toughness →		
				PH5705	PH5320	PHP920	PH7920	PHP930	PHH930
P	1	Unalloyed Steel	125-220	-	-	180-250	180-240	160-230	-
	2	Low-Alloyed Steel	220-280	-	-	160-230	160-220	140-210	-
	3	High-Alloyed Steel	280-380	-	-	140-220	140-210	120-200	-
M	4	SS - Ferritic / Martensitic	200-330	-	-	-	-	-	140-210
	5	SS - Austenitic	200-330	-	-	-	-	-	120-170
	6	SS - Austenitic-ferritic (Duplex)	230-260	-	-	-	-	-	100-150
K	7	Malleable Cast Iron	130-230	160-290	150-280	160-270	160-260	150-250	-
	8	Grey Cast Iron	180-245	170-320	160-320	140-250	140-240	140-230	-
	9	Nodular Cast iron	160-250	140-200	100-190	120-210	120-200	100-200	-
S	11	Heat Resistant Super Alloys	200-320	-	-	-	-	-	30-110

ISO	PSM	Material	HB (Brinell)	Vc (m/min)				Feed fz (mm/t)
				← Wear Resistance		Toughness →		
				PH7930	PH5740	PHS740	PH7740	SNH(K)X/ONH(K)X
P	1	Unalloyed Steel	125-220	160-220	-	140-220	140-200	0,15 (0,25) 0,4
	2	Low-Alloyed Steel	220-280	140-200	-	120-200	130-180	0,15 (0,25) 0,4
	3	High-Alloyed Steel	280-380	120-190	-	100-190	100-170	0,15 (0,25) 0,4
M	4	SS - Ferritic / Martensitic	200-330	140-200	-	-	130-180	0,1 (0,20) 0,3
	5	SS - Austenitic	200-330	120-160	-	-	110-160	0,1 (0,20) 0,3
	6	SS - Austenitic-ferritic (Duplex)	230-260	100-140	-	-	90-150	0,1 (0,20) 0,3
K	7	Malleable Cast Iron	130-230	150-240	160-260	-	140-220	0,15 (0,25) 0,4
	8	Grey Cast Iron	180-245	140-230	140-240	-	120-210	0,14 (0,25) 0,4
	9	Nodular Cast iron	160-250	100-190	120-200	-	100-190	0,14 (0,25) 0,4
S	11	Heat Resistant Super Alloys	200-320	30-100	-	-	30-100	0,1 (0,15) 0,17

(Note 1) Cutting conditions $a_e/D_c=70\%$.

(Note 2) It's possible to occur vibrations in certain cases. Please reduce depth of cut and / or reduce cutting conditions in following cases:

- When using long shank;
- When using long tool overhang with arbor type;
- When application has poor clamping rigidity or when using a low rigidity machine.

(Note 3) PH5... and PHS... can be used wet or dry. PH7... use only air.

CHIP-BREAKER SELECTION GUIDE | Guia para aplicações do quebra- aparas | Guía para aplicación del rompevirutas

Selection Example:

ISO	PSM	Material	HB (Brinell)	Vc (m/min)		Feed fz (mm/t)		
				← Wear Resistance			Toughness →	
				PH5705	PH5740		SNHX/ONHX	
K	7	Malleable cast iron	130-230	170 (190) 305	150 (170) 260	0,15 (0,25) 0,40		
	8	Grey cast iron	180-245	180 (240) 350	155 (190) 290	0,14 (0,25) 0,40		
	9	Nodular cast iron	160-250	130 (160) 210	115 (140) 180	0,14 (0,25) 0,40		

This example shows the recommended starting cutting conditions, indicated in **Bold type**.

ISO	PSM	Material	HB (Brinell)	Chip-Breaker Application	
				1 st choice	Alternative
P	1	Unalloyed Steel	125-220	LP	MP
	2	Low-Alloyed Steel	220-280	LP	MP
	3	High-Alloyed Steel	280-380	MP	-
M	4	SS - Ferritic / Martensitic	200-330	LS	LP
	5	SS - Austenitic	200-330	LS	LP
	6	SS - Austenitic-ferritic (Duplex)	230-260	LS	LP
K	7	Malleable Cast Iron	130-230	MK	-
	8	Grey Cast Iron	180-245	MK	-
	9	Nodular Cast iron	160-250	MK	LP
S	11	Heat Resistant Super Alloys	200-320	LS	LP

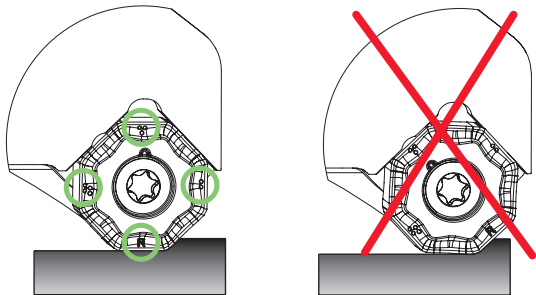

The points and letter (R or L) on the insert indicates the side that should be parallel to the workspace material.

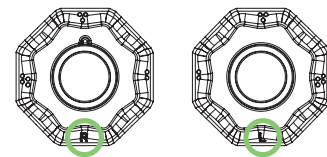

Wiper insert with 4 Right and 4 Left-hand cutting edges. The side work of the insert it's indicated by the letter R (Right) & L (Left).

WIPER INSERTS

Recommended Cutting Conditions:

- f_z should be equal to $0,8 \times F_w / Z$
- Axial depth of cut is 0,5 to 0,8mm.

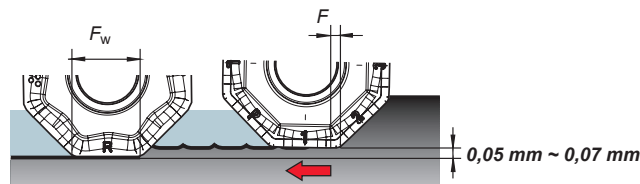

Example:

- The width of the parallel land (F) of the insert is 1mm.
- To obtain a good surface finishing, the feed per revolution should be a maximum of 80% of 1mm = 0,8mm.
- The wiper insert will have a parallel land (F_w) with a width of 6,0mm.
- Result: Feed per revolution (f_n) could be increased from 0,8mm to 4,8mm (80% of 6,0mm).

Note: Other limitations, such as machine power, must be taken into consideration.

How to use a wiper insert:

- Since wiper is one corner use to standard cutters, please attach the insert with the parallel land down to the workspace cutting surface.
- The points and the letter (R or L) on the insert indicates the side that should be parallel to the workspace material.
- The side work of the insert it's indicated by the letter (R - Right & L - Left).

LINEPRO 06045

A

MILLING

Overview

Face milling

Hifeed milling

Shoulder milling

Profile milling

Hardmill

Center & Chamfer

Spot face

Spare Parts

Technical Data

End Mills



Arbor Mounting

$K_r=45^\circ$ | $\gamma_p=+19^\circ$

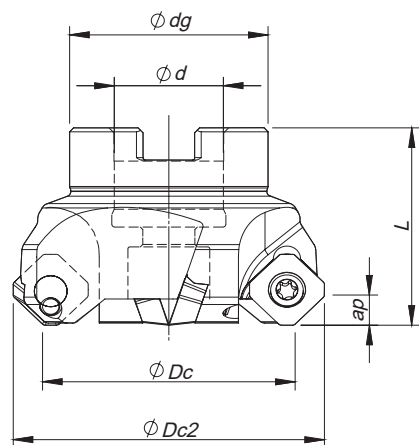

Order code Código	Reference Referência Referencia		Dimensions Dimensões Dimensiones (mm)					Kg	Specifications		Insert Pastilha Inserto	Stock
			ϕDc	$\phi Dc2$	ϕd	ϕdg	L		Arbor Type	Ap max (mm)		
181163200	050A06045-04-19-022040	4	50	62	22	42	40	0,350	A	6,0	SE...T/W 1204	○
181148800	063A06045-05-19-022050	5	63	75	22	42	50	0,800	A	6,0	SE...T/W 1204	○
181148900	080A06045-06-19-027050	6	80	92	27	50	50	1,150	A	6,0	SE...T/W 1204	○
181149000	100A06045-06-19-032050	6	100	112	32	64	50	1,700	A	6,0	SE...T/W 1204	○
181163300	125A06045-07-19-040063	7	125	132	40	85	63	2,750	B	6,0	SE...T/W 1204	○
181040300	160A06045-08-19-U040063	8	160	172	40	100	63	4,600	C	6,0	SE...T/W 1204	○

⊗ Stock item | Produto de stock | Itens de stock

○ Available under request (see page A-9) | Disponível sobre consulta (consulte a página A-9) | Disponible bajo consulta (mire pagina A-9)

SEH... 1204 || Inserts | Pastilhas | Plaquetas

SEHW



SEHT



SEHT-LN



SEHW | SEHT | SEHT-LN

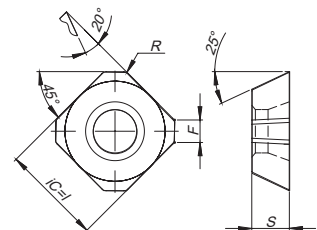

Geometry code	ISO Reference	P		M	K		N	Dimensions Dimensões Dimensiones (mm)			
		PVD			PVD		UNC	iC	S	I	F
		68	I5	I5	68	I5	10				
1110216	SEHT 1204 AFEN	⊗	⊗	⊗	⊗	⊗		12,70	4,76	12,70	2,80
1110218	SEHT 1204 AFTN	⊗	⊗	⊗	⊗	⊗		12,70	4,76	12,70	2,80
1112283	SEHT 1204 AFFN-LN						⊗	12,70	4,76	12,70	2,00
1110219	SEHW 1204 AFEN	⊗	⊗	⊗	⊗	⊗		12,70	4,76	12,70	2,80
1110222	SEHW 1204 AFTN	⊗	⊗	⊗	⊗	⊗		12,70	4,76	12,70	2,80

⊗ First choice | Primeira opção | 1ª opción

⊗ Stock item | Produto de stock | Itens de stock

○ Available under request (see page A-9) | Disponível sobre consulta (consulte a página A-9) | Disponible bajo consulta (mire pagina A-9)

Insert order code = (1) Geometry Code + (2) Grade Code

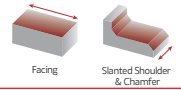

SPARE PARTS || Complementos | Repuestos

Cutter ØDc	Insert Screw	Key (Torx)	Order separately	
			Key (Torx - Nm)	Torque Value
A06045 - 50 - 160	P0501100	PT20	DT2050	5,0

Note: The toolholder is supplied with the XT/PT key. To order the DT key please check the page A-241.
Check the procedures for the clamping screws on the page A-241.

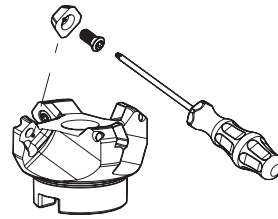

GRADES SELECTION GUIDE || Guia para seleção de graus | Tabla para selección de calidades

ISO	PSM	Material	HB (Brinell)	Grades		
				← Wear Resistance		Toughness →
				PH0910	PH6920	PH6740
P	1	Unalloyed steel	125-220	●	✓	✓
	2	Low-alloyed steel	220-280		✓	✓
	3	High-alloy steel	280-380		✓	✓
M	4	SS - Ferritic / Martensitic	200-330			✓
	5	SS - Austenitic	200-330			✓
	6	SS - Austenitic-ferritic (Duplex)	230-260			✓
K	7	Malleable cast iron	130-230		✓	✓
	8	Grey cast iron	180-245		✓	✓
	9	Nodular cast iron	160-250		✓	✓
N	10	Aluminium and Non Ferrous	30-130	✓		

● Good Conditions
 ● Average Conditions
 ● Difficult Conditions

RECOMMENDED CUTTING CONDITIONS || Condições de corte recomendadas | Condiciones de corte recomendables

ISO	PSM	Material	HB (Brinell)	Vc (m/min)			Feed fz (mm/t)		
				← Wear Resistance		Toughness →			
				PH0910	PH6920	PH6740	SEHT 1204...	SEHT 1204 LN	SEHW 1204...
P	1	Unalloyed Steel	125-220	-	150-230	130-160	0,10-0,20	-	0,10-0,20
	2	Low-Alloyed Steel	220-280	-	140-220	120-150	0,10-0,20	-	0,10-0,20
	3	High-Alloyed Steel	280-380	-	130-180	100-130	0,10-0,20	-	0,10-0,20
M	4	SS - Ferritic / Martensitic	200-330	-	-	100-120	0,10-0,15	-	0,10-0,20
	5	SS - Austenitic	200-330	-	-	80-110	0,10-0,15	-	0,10-0,20
	6	SS - Austenitic-ferritic (Duplex)	230-260	-	-	70-100	0,10-0,15	-	0,10-0,20
K	7	Malleable Cast Iron	130-230	-	-	130-250	0,10-0,25	-	0,10-0,25
	8	Grey Cast Iron	180-245	-	-	110-220	0,10-0,25	-	0,10-0,25
	9	Nodular Cast iron	160-250	-	-	80-170	0,10-0,25	-	0,10-0,25
N	10	Aluminium and Non Ferrous	30-130	350-1400	-	-	0,10-0,25	-	-

(Note 1) Cutting conditions ae/DC=70%

(Note 2) Cutting conditions should be adjusted according to the machine and work rigidity.

(Note 3) If chattering occurs, reduce ap and Vc by 30% and keep the same fz per tooth.

CHIP-BREAKER SELECTION GUIDE || Guia para aplicações do quebra- aparas | Guía para aplicación del rompevirutas

ISO	PSM	Material	HB (Brinell)	Chip-Breaker Application	
				1st choice	Difficult Operations
P	1	Unalloyed Steel	125-220	SEHT 12... AFEN	SEHW 12... AFEN
	2	Low-Alloyed Steel	220-280	SEHT 12... AFTN	SEHW 12... AFTN
	3	High-Alloyed Steel	280-380	SEHT 12... AFTN	SEHW 12... AFTN
M	4	SS - Ferritic / Martensitic	200-330	SEHT 12... AFEN	SEHW 12... AFEN
	5	SS - Austenitic	200-330	SEHT 12... AFEN	SEHW 12... AFEN
	6	SS - Austenitic-ferritic (Duplex)	230-260	SEHW 12... AFEN	-
K	7	Malleable Cast Iron	130-230	SEHT 12... AFEN	SEHW 12... AFEN
	8	Grey Cast Iron	180-245	SEHT 12... AFEN	SEHW 12... AFEN
	9	Nodular Cast iron	160-250	SEHW 12... AFEN	SEHW 12... AFTN
N	10	Aluminium and Non Ferrous	30-130	SEHT 12... AFFN-LN	-

LINEPRO 09945

A

MILLING

Overview

Face milling

Hi-feed milling

Shoulder milling

Profile milling

Hardmill

Center & Chamfer

Spotface

Spare Parts

Technical Data

End Mills

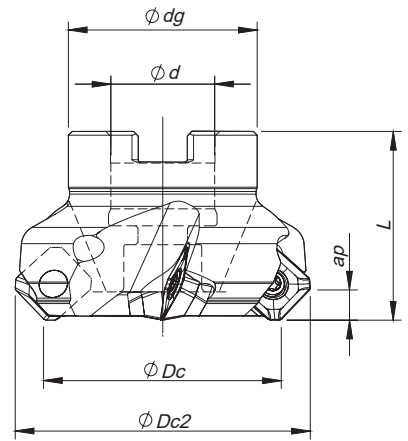

Arbor Mounting

$$K_r=45^\circ \mid \gamma_p=+20^\circ \sim +21^\circ$$

Order code Código	Reference Referência Referencia		Dimensions Dimensões Dimensiones (mm)					Kg	Specifications		Insert Pastilha Inserto	Stock
			ϕDc	$\phi Dc2$	ϕd	ϕdg	L		Arbor Type	A_p max (mm)		
181034700	050A09945-04-20-U022040	4	50	63	22	40	40	0,36	A	6,0	SE...13T3	
181024200	063A09945-05-21-U022040	5	63	76	22	48	40	0,59	A	6,0	SE...13T3	
181024300	080A09945-06-21-U027050	6	80	93	27	60	50	1,02	B	6,0	SE...13T3	
181024400	100A09945-07-21-U032050	7	100	113	32	70	50	1,52	B	6,0	SE...13T3	
181024500	125A09945-08-21-U040063	8	125	138	40	90	63	3,16	B	6,0	SE...13T3	
181024600	160A09945-10-21-U040063	10	160	173	40	110	63	4,61	C	6,0	SE...13T3	
181051400	250A09945-24-21-U060063L	24	250	263	60	172	63	13,89	C	6,0	SE...13T3	
181024800	250A09945-24-21-U060063	24	250	263	60	172	63	13,89	C	6,0	SE...13T3	

Stock item | Produto de stock | Itens de stock

Available under request (see page A-9) | Disponível sobre consulta (consulte a página A-9) | Disponible bajo consulta (mire página A-9)

SPARE PARTS | Complementos | Repuestos

Cutter ϕDc	Insert Screw	Key (Torx)	Order separately		Order separately	
			Key (Torx - Nm)	Torque Value	Shim	Shim Screw
A09945 - 50 - 80	P0351200	XT15	DT1530	3,0	CS130300	T0503509
A09945 - 100-250	P0351200	PT15	DT1530	3,0	CS130300	T0503509

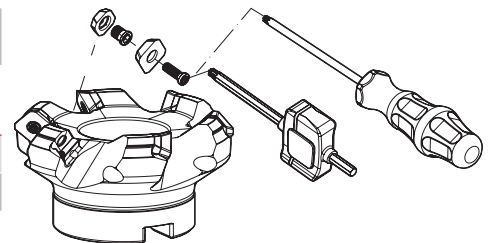

Note: The toolholder is supplied with the XT/PT key. To order the DT key please check the page A-241.
Check the procedures for the clamping screws on the page A-241.

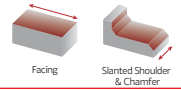

SE... 13T3 | Inserts | Pastilhas | Plaquetas

SEHT



SEHW



SEHT-LN



SEHT | SEHW | SEHT-LN

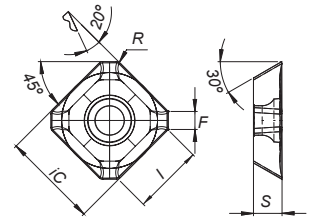

SEHT-W

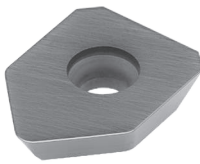

SEHT-W

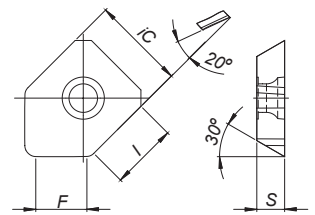

	(2) Grade code	P		M	K		N	Dimensions Dimensões Dimensiones (mm)			
		PVD		PVD			UNC	iC	S	I	F
		68	I5	I5	68	I5	10				
(1) Geometry code	ISO Reference	PH6920	PH6740	PH6740	PH6920	PH6740	PH0910				
1110559	SEHT 13T3 AGSN	⊗	⊗	⊗	⊗	⊗		13,35	3,97	10,0	2,0
1111586	SEHT 13T3 AGFN-LN						⊗	13,35	3,97	10,0	2,3
1110627	SEHT 13T3 AGSN-W	⊗			⊗	⊗		13,35	3,97	10,0	8,2
1111146	SEHW 13T3 AGFN	⊗			⊗			13,35	3,97	10,0	2,0

⊗ First choice | Primeira opção | 1ª opción ⊗ Stock item | Produto de stock | Itens de stock ○ Available under request (see page A-9) | Disponível sobre consulta (consulte a página A-9) | Disponible bajo consulta (mire página A-9) Insert order code = (1) Geometry Code + (2) Grade Code

GRADES SELECTION GUIDE | Guia para selecção de graus | Tabla para selección de calidades

ISO	Material	HB (Brinell)	Grades		
			← Wear Resistance		Toughness →
			PH0910	PH6920	PH6740
P	Unalloyed steel	125-220	●	●	●
	Low-alloyed steel	220-280		●	●
	High-alloy steel	280-380		●	●
M	SS - Ferritic / Martensitic	200-330			●
	SS - Austenitic	200-330			●
	SS - Austenitic-ferritic (Duplex)	230-260			●
K	Malleable cast iron	130-230		●	●
	Grey cast iron	180-245		●	●
	Nodular cast iron	160-250		●	●
N	Aluminium and Non Ferrous	30-130	●		

● Good Conditions
● Average Conditions
● Difficult Conditions

RECOMMENDED CUTTING CONDITIONS | Condições de corte recomendadas | Condiciones de corte recomendables

ISO	PSM	Material	HB (Brinell)	Vc (m/min)			Feed fz (mm/t)			
				← Wear Resistance		Toughness →	SEHT 13T3 AGSN	SEHW 13T3 AGFN	SEHT 13T3 AGFN-LN	SEHT 13T3 AGSN-W
				PH0910	PH6920	PH6740				
P	1	Unalloyed Steel	125-220	-	180-340	180-240	0,10-0,25	-	-	0,10-0,30
	2	Low-Alloyed Steel	220-280	-	180-340	160-220	0,10-0,20	-	-	0,10-0,30
	3	High-Alloyed Steel	280-380	-	180-330	140-210	0,10-0,20	-	-	0,10-0,30
M	4	SS - Ferritic / Martensitic	200-330	-	-	140-220	0,10-0,20	-	-	-
	5	SS - Austenitic	200-330	-	-	130-180	0,10-0,20	-	-	-
	6	SS - Austenitic-ferritic (Duplex)	230-260	-	-	120-160	0,10-0,20	-	-	-
K	7	Malleable Cast Iron	130-230	-	-	160-260	0,10-0,25	0,10-0,25	-	0,10-0,30
	8	Grey Cast Iron	180-245	-	-	140-240	0,10-0,25	0,10-0,25	-	0,10-0,30
	9	Nodular Cast iron	160-250	-	-	120-200	0,10-0,20	0,10-0,20	-	0,10-0,30
N	10	Aluminium and Non Ferrous	30-130	350-1400	-	-	0,10-0,20	-	0,10-0,20	-

(Note 1) Cutting conditions ae/DC=70%

(Note 2) Cutting conditions should be adjusted according to the machine and work rigidity.

(Note 3) If chattering occurs, reduce ap and Vc by 30% and keep the same fz per tooth.

CHIP-BREAKER SELECTION GUIDE | Guia para aplicações do quebra- aparas | Guía para aplicación del rompevirutas

ISO	PSM	Material	HB (Brinell)	Chip-Breaker Application	
				1st choice	Difficult Operations
P	1	Unalloyed Steel	125-220	SEHT... AGSN	-
	2	Low-Alloyed Steel	220-280	SEHT... AGSN	-
	3	High-Alloyed Steel	280-380	SEHT... AGSN	-
M	4	SS - Ferritic / Martensitic	200-330	SEHT... AGSN	SEHW... AGFN
	5	SS - Austenitic	200-330	SEHT... AGSN	SEHW... AGFN
	6	SS - Austenitic-ferritic (Duplex)	230-260	SEHT... AGSN	SEHW... AGFN
K	7	Malleable Cast Iron	130-230	SEHW... AGFN	-
	8	Grey Cast Iron	180-245	SEHW... AGFN	-
	9	Nodular Cast iron	160-250	SEHW... AGFN	-
N	10	Aluminium and Non Ferrous	30-130	SEHT... AGFN-LN	-

WIPER INSERTS

Rec. Cutting Conditions

- F_w at least 40% larger than f_n ($f_n = f_z \times Z$);
- Axial depth of cut is 0,5 - 0,8 mm;

Example:

- The width of parallel land (F) of the SEHT insert is 2,0 mm.
 - With a cutter of 10 inserts and using a feed per tooth (f_z) of 0,3 mm, the feed per revolution (f_n) will be 3 mm, i.e. 66% bigger than the parallel land.
 - To obtain a good surface finishing, the feed per revolution should be a maximum 80% of 2,0 mm = 1,6 mm.
 - The wiper insert will have a parallel land (F_w) with a width of approximately 8,2 mm.
 - Result: Feed per revolution (f_n) could be increased from 1,6 mm to 60% of 6,0 mm = 4,9 mm.
- Note: Other limitations, such as machine power, must be taken into consideration.

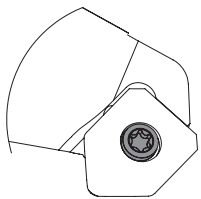

Fig. A

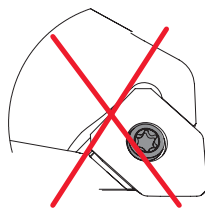

Fig. B

When using wiper insert, install the insert as shown on Fig. A.
If the insert is installed as shown on Fig. B breakage of the insert is inevitable and normal surface finish can not be obtained.

LINEPRO 00036

A

MILLING

Overview

Face milling

Hi-feed milling

Shoulder milling

Profile milling

Hardmill

Center & Chamfer

Spot face

Spare Parts

Technical Data

End Mills

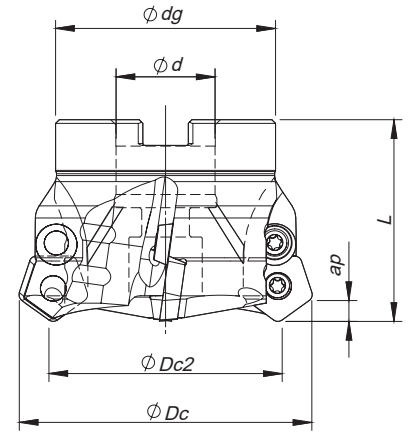
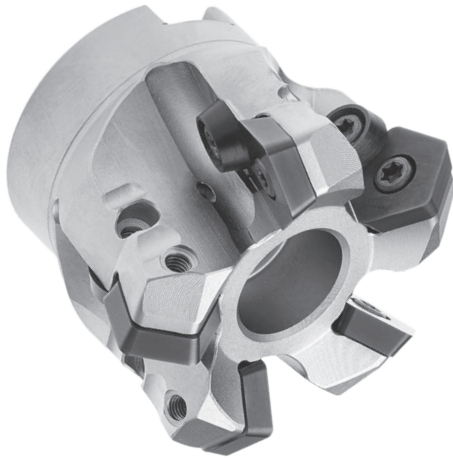

Arbor Mounting

$K_r=36^\circ$ | $\gamma_p=+9^\circ$ | $R_p=7,0$

Order code Código	Reference Referência Referencia		Dimensions Dimensões Dimensiones (mm)					Kg	Specifications		Insert Pastilha Inserto	Stock
			ϕDc	$\phi Dc2$	ϕd	ϕdg	L		Arbor Type	A_p max (mm)		
181009800	066C00036-05-09-027055		66	47,5	27	48	55	0,520	A	5,5	PD...1204	
181010400	080C00036-06-09-027055		80	61,5	27	60	55	0,940	A	5,5	PD...1204	
181018100	100C00036-07-09-U032055		100	81,5	32	70	55	1,400	B	5,5	PD...1204	
181001100	125C00036-08-09-U040055		125	106,5	40	90	55	2,420	B	5,5	PD...1204	
181002700	160C00036-09-09-U040055		160	141,5	40	120	55	4,590	B	5,5	PD...1204	

Stock item | Produto de stock | Itens de stock

Available under request (see page A-9) | Disponível sobre consulta (consulte a página A-9) | Disponible bajo consulta (mire pagina A-9)

PD... 1204... || Inserts | Pastilhas | Plaquetas

PDMW

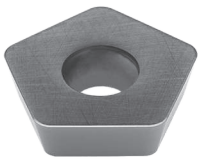

PDHW

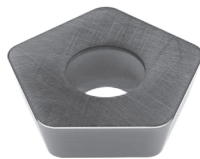

PDM(H)W

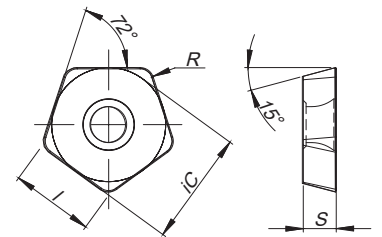

		P			K	Dimensions Dimensões Dimensiones (mm)			
		PVD				PVD	iC	S	I
⁽²⁾ Grade code	68	78	86	68					
⁽¹⁾ Geometry code	ISO Reference	PH6920	PH6125	PH6135	PH6920				
1110555	PDMW 120420 T					16,52	4,76	12,0	2,0
1110554	PDHW 120420 T					16,52	4,76	12,0	2,0

First choice | Primeira opção | 1ª opción

Stock item | Produto de stock | Itens de stock

Available under request (see page A-9) | Disponível sobre consulta (consulte a página A-9) | Disponible bajo consulta (mire pagina A-9)

Insert order code = (1) Geometry Code + (2) Grade Code

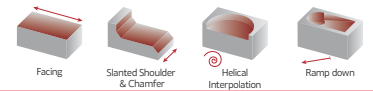

SPARE PARTS | Complementos | Repuestos

ScrewCutter ØDc	Insert Screw	Key (Torx)	Order separately		Order separately	
			Key (Torx - Nm)	Torque Value	Washer	Washer Screw
C00036 – 66-80	P0451001	XT20	DT2050	5,0	HC01200	P0451001
C00036 – 100-160	P0451001	PT20	DT2050	5,0	HC01200	P0451001

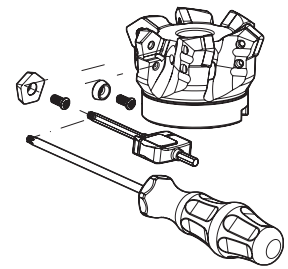

Note: The toolholder is supplied with the XT/PT key. To order the DT key please check the page A-241.
Check the procedures for the clamping screws on the page A-241.

RECOMMENDED CUTTING CONDITIONS | Condições de corte recomendadas | Condiciones de corte recomendables

ISO	PSM	Material	HB (Brinell)	Vc (m/min)			Feed fz (mm/t)
				← Wear Resistance	Toughness →		
				PH6920	PH6125	PH6135	PDHW / PDMW
P	1	Unalloyed Steel	125-220	150-230	160-190	150-180	0,25-0,50
	2	Low-Alloyed Steel	220-280	140-220	140-180	140-170	0,25-0,50
	3	High-Alloyed Steel	280-380	130-180	130-160	120-150	0,25-0,40
K	7	Malleable Cast Iron	130-230	150-280	-	-	0,25-0,60
	8	Grey Cast Iron	180-245	130-230	-	-	0,25-0,60
	9	Nodular Cast iron	160-250	80-190	-	-	0,25-0,60

(Note 1) Cutting conditions ae/DC=70%

(Note 2) Cutting conditions should be adjusted according to the machine and work rigidity.

(Note 3) If chattering occurs, reduce ap and Vc by 30% and keep the same fz per tooth.

RAMPING AND HELICAL INTERPOLATION

Descida em rampa e interpolação helicoidal | Bajada en rampa e interpolación circular

Ramping

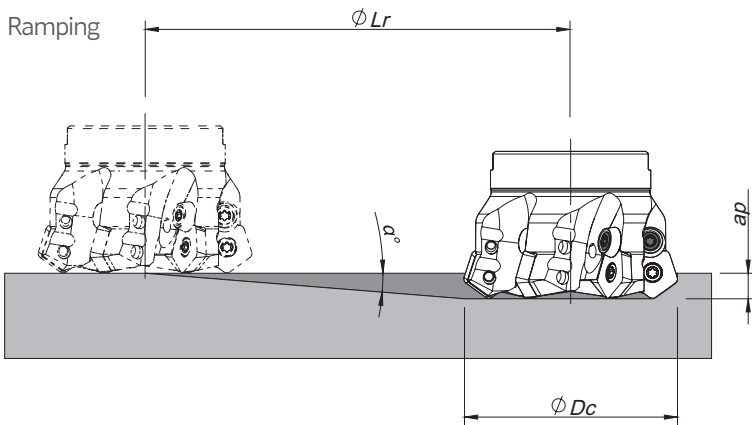

Helical Interpolation

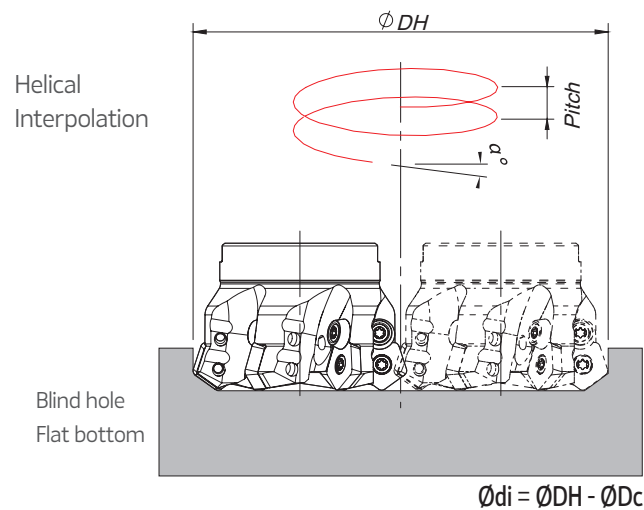

ØDc	Ramping			Helical Interpolation		
	Max Ramp a°	Max ap	Min Lr	ØDHmin	ØDHmax	Max Pitch/Rev.
66	8	5,5	39,1	113,3	-	20,9
				-	130,4	28,4
80	6	5,5	52,3	141,3	-	20,2
				-	158,4	25,9
100	4,3	5,5	73,1	181,3	-	19,2
				-	198,4	23,2
125	3,2	5,5	98,4	231,3	-	18,7
				-	248,4	21,7
160	2,4	5,5	131,2	301,3	-	18,6
				-	318,4	20,8

Note: During helical interpolation do not exceed max Pitch.

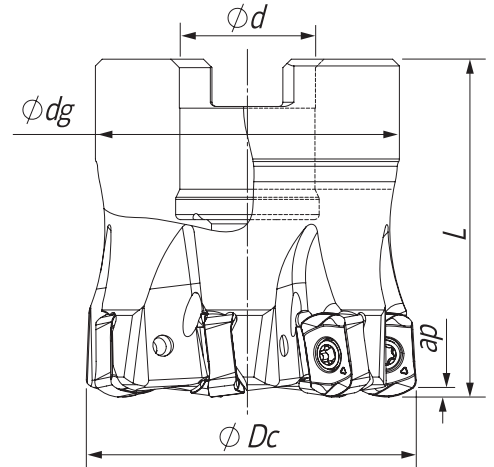
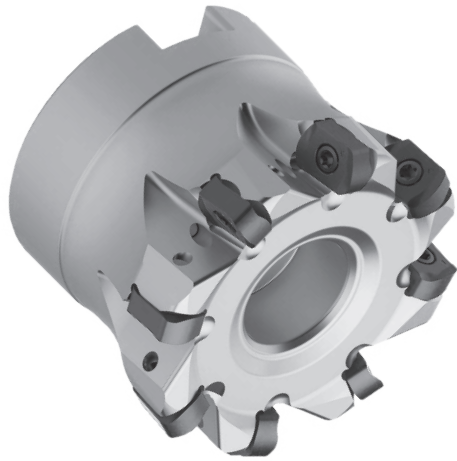

Arbor Mounting
 $K_r=20^\circ$ | $\gamma_p=-7^\circ$ | $R_p=1,8$

Order code Código	Reference Referência Referencia		Dimensions Dimensões Dimensiones (mm)				Kg	Specifications		Insert	Stock
			ϕDc	ϕd	ϕdg	L		Ap max (mm)	Arbor Type		
181152300	040A16320-07-07-016040	7	40	16	36	40	0,20	1,00	A	XNKU 06...	
181157500	050A16320-06-07-022040	6	50	22	42	40	0,25	1,00	A	XNKU 06...	
181152400	050A16320-08-07-022040	8	50	22	42	40	0,29	1,00	A	XNKU 06...	
181152500	052A16320-08-07-022040	8	52	22	40	40	0,39	1,00	A	XNKU 06...	
181152600	063A16320-09-07-022040	9	63	22	48	40	0,50	1,00	A	XNKU 06...	

Stock item | Produto de stock | Itens de stock

Available under request (see page A-9) | Disponível sobre consulta (consulte a página A-9) | Disponible bajo consulta (mire pagina A-9)

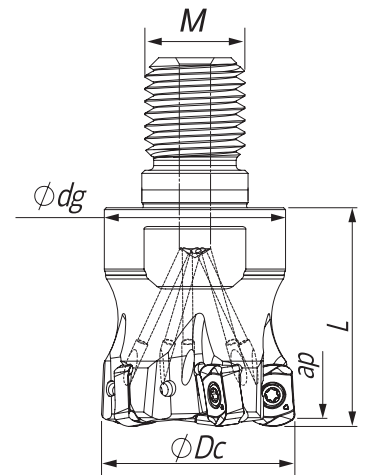

Threaded Coupling
 $K_r=20^\circ$ | $\gamma_p=-7^\circ$ | $R_p=1,8$

Order code Código	Reference Referência Referencia		Dimensions Dimensões Dimensiones (mm)				Kg	Specifications		Insert	Stock
			ϕDc	ϕM	ϕdg	L		Ap max (mm)	Arbor Type		
181151300	016R16320-02-07-M08025	2	16	M08	13	25	0,02	1,00	XNKU 06...		
181151400	020R16320-03-07-M10028	3	20	M10	18	28	0,05	1,00	XNKU 06...		
181151500	025R16320-04-07-M12030	4	25	M12	18	30	0,07	1,00	XNKU 06...		
181148000	032R16320-05-07-M16035	5	32	M16	29	35	0,16	1,00	XNKU 06...		
181151600	035R16320-06-07-M16035	6	35	M16	29	35	0,17	1,00	XNKU 06...		
181151700	040R16320-05-07-M16045	5	40	M16	29	45	0,24	1,00	XNKU 06...		
181151800	042R16320-07-07-M16035	7	42	M16	29	35	0,24	1,00	XNKU 06...		

Stock item | Produto de stock | Itens de stock

Available under request (see page A-9) | Disponível sobre consulta (consulte a página A-9) | Disponible bajo consulta (mire pagina A-9)

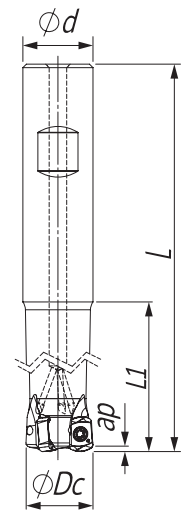
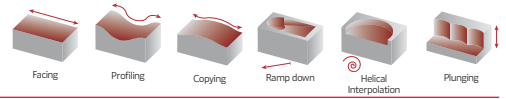

Weldon Shank
 $K_r=20^\circ$ | $\gamma_p=-7^\circ$ | $R_p=1,8$

Order code Código	Reference Referência Referencia		Dimensions Dimensões Dimensiones (mm)				Kg	Specifications		Insert	Stock
			ϕDc	ϕd	L	L1		A_p max (mm)			
181161000	016W16320-02-07-016150	2	16	16	150	50	0,19	1,00	XNKU 06...		
181151900	020W16320-03-07-020160	3	20	20	160	90	0,29	1,00	XNKU 06...		
181152000	025W16320-04-07-025180	4	25	25	180	100	0,40	1,00	XNKU 06...		
181152100	032W16320-05-07-032200	5	32	32	200	120	1,10	1,00	XNKU 06...		

Stock item | Produto de stock | Itens de stock

Available under request (see page A-9) | Disponível sobre consulta (consulte a página A-9) | Disponible bajo consulta (mire pagina A-9)

XNKU 06T3... || Inserts | Pastilhas | Plaquetas

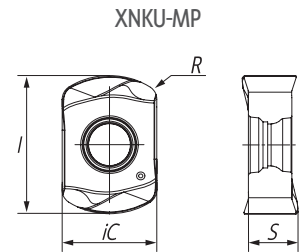
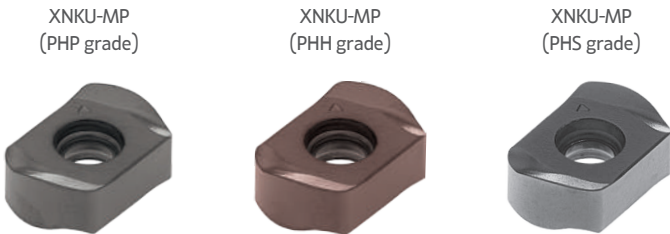

NEW	(1) Geometry code	ISO Reference	P				M		K		S		Dimensions Dimensões Dimensiones (mm)			
			CVD		PVD		CVD	PVD	CVD	PVD	CVD	PVD	iC	S	I	R
			T9	G4	T1	X9	T9	X9	T9	T1	T9	X9				
1112802	XNKU 06T310-MP											6,85	3,60	10,00	1,00	

First choice | Primeira opção | 1ª opção

Stock item | Produto de stock | Itens de stock

Available under request | Disponível sobre consulta
Disponível sobre consulta

Insert order code = (1) Geometry Code + (2) Grade Code

SPARE PARTS Complementos | Repuestos

Cutter ϕDc	Order separately			
	Insert Screw	Key (Torx)	Key (Torx - Nm)	Torque Value
A16320 - 40-63	P0250704	XT08	DT0812	1,20
R16320 - 20-42	P0250704	XT08	DT0812	1,20
W16320 - 20-32	P0250704	XT08	DT0812	1,20

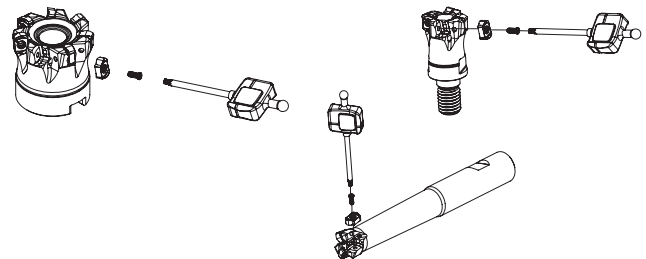

PROGRAMMING DATA | Dados para programação | Datos para la programación

Insert	Programming Data			
	Rp	X	b	ae
XNKU 06T310-MP	1,8	0,4	3,6	3,4

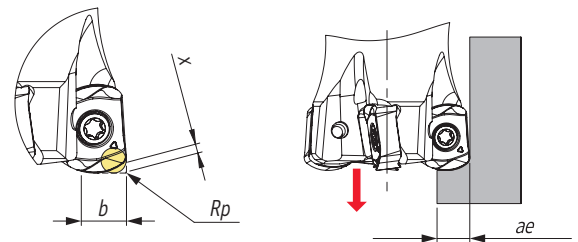

GRADES SELECTION GUIDE | Guia para selecção de graus | Tabla para selección de calidades

ISO	PSM	Material	HB (Brinell)	Grades				
				← Wear Resistance				Toughness →
				PHP910	PHP920	PHP930	PHH930	PHS740
P	1	Unalloyed Steel	125-220	●	●	●	●	●
	2	Low-Alloyed Steel	220-280	●	●	●	●	●
	3	High-Alloyed Steel	280-380	●	●	●	●	●
M	4	SS - Ferritic / Martensitic	200-330	●	●	●	●	●
	5	SS - Austenitic	200-330	●	●	●	●	●
	6	SS - Austenitic-ferritic (Duplex)	230-260	●	●	●	●	●
K	7	Malleable Cast Iron	130-230	●	●	●	●	●
	8	Grey Cast Iron	180-245	●	●	●	●	●
	9	Nodular Cast iron	160-250	●	●	●	●	●
S	11	Heat Resistant Super Alloys	200-320	●	●	●	●	●

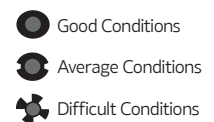

RECOMMENDED CUTTING CONDITIONS | Condições de corte recomendadas | Condiciones de corte recomendables

ISO	PSM	Material	HB (Brinell)	Vc (m/min)					Feed fz (mm/t)
				← Wear Resistance				Toughness →	
				PHP910	PHP920	PHP930	PHH930	PHS740	
P	1	Unalloyed Steel	125-220	180-250	180-250	160-230	-	160-230	0,50-1,50
	2	Low-Alloyed Steel	220-280	160-240	170-210	150-190	-	150-190	0,50-1,50
	3	High-Alloyed Steel	280-380	140-230	160-200	140-180	-	140-180	0,50-1,50
M	4	SS - Ferritic / Martensitic	200-330	-	-	-	130-170	120-180	0,50-1,40
	5	SS - Austenitic	200-330	-	-	-	100-160	100-150	0,50-1,40
	6	SS - Austenitic-ferritic (Duplex)	230-260	-	-	-	80-140	70-130	0,50-1,40
K	7	Malleable Cast Iron	130-230	180-300	180-320	-	-	160-300	0,50-1,50
	8	Grey Cast Iron	180-245	160-250	170-280	-	-	150-260	0,50-1,50
	9	Nodular Cast iron	160-250	150-210	100-240	-	-	80-220	0,50-1,50
S	11	Heat Resistant Super Alloys	200-320	-	-	-	30-75	30-70	0,50-1,30

(Note 1) Cutting conditions $a_e/D_c=70\%$.

(Note 2) It's possible to occur vibrations in certain cases. Please reduce depth of cut and / or reduce cutting conditions in following cases:

- When using long shank;
- When using long tool overhang with arbor type;
- When application has poor clamping rigidity or when using a low rigidity machine.

(Note 3) When using $\varnothing D_c=16\text{mm}$ apply 70% or less feed (fz) from the table.

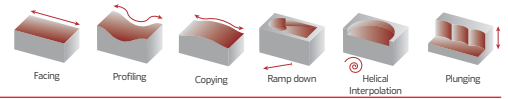

RAMPING AND HELICAL INTERPOLATION

Descida em rampa e interpolação helicoidal | Bajada en rampa e interpolación circular

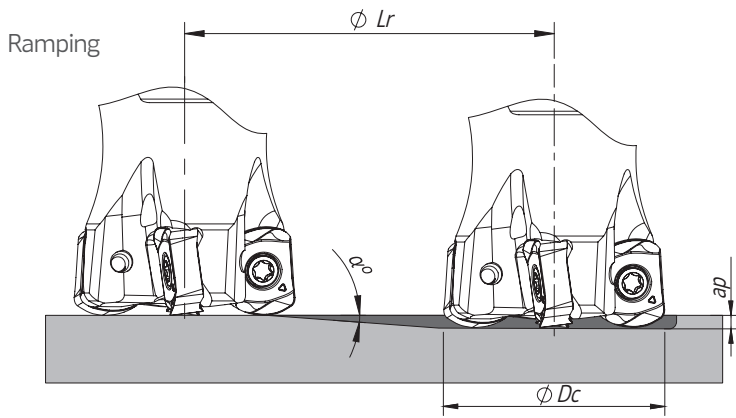

Helical Interpolation

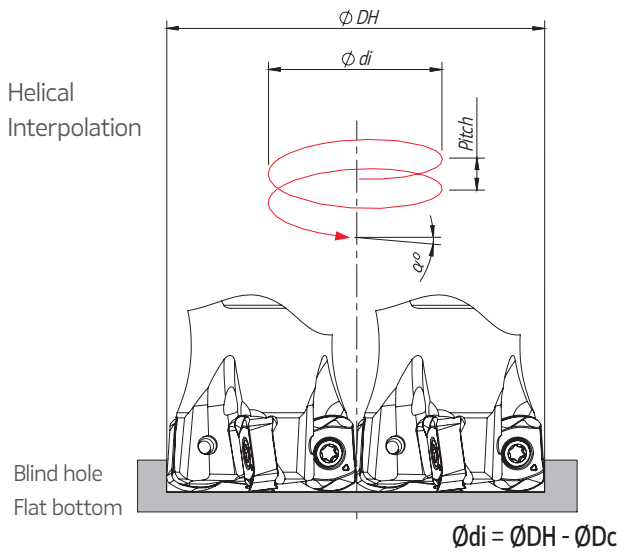

ØDc	Ramping			Helical Interpolation		
	Max Ramp a°	Max ap	Min Lr	ØDHmin	ØDHmax	Max Pitch/Rev.
16	0,5	1	114,6	24,8 -	- 30,0	0,2 0,3
20	0,5	1	114,6	32,8 -	- 38,0	0,3 0,4
25	0,8	1	71,6	42,8 -	- 48,0	0,7 1,0
32	0,8	1	71,6	56,8 -	- 62,0	1,0 1,3
35	0,5	1	114,6	62,8 -	- 68,0	0,7 0,9
40	0,4	1	143,2	72,8 -	- 78,0	0,7 0,8
42	0,4	1	143,2	76,8 -	- 82,0	0,7 0,8
50	0,3	1	191,0	92,8 -	- 98,0	0,7 0,7
52	0,3	1	191,0	96,8 -	- 102,0	0,7 0,8
63	0,25	1	229,2	118,8 -	- 124,0	0,7 0,8

Note: During helical interpolation do not exceed max Pitch.
 (*) Down cutting is recommended, tool pass rotation should be counter-clockwise.
 (*) In case of ramping and helical interpolation, apply 70% or less feed (fz) from recommended cutting conditions table.

PLUNGING | Mergulho | Plunge

L ≤ 3Dc	L > 3Dc	S max.
fz (mm/t)		
0,08-0,15	0,05 - 0,10	$S_{max} = \sqrt{Dc \cdot Dr - Dr^2}$

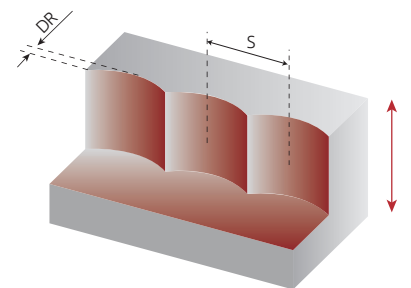

S max and DR corresponding cutting diameter Dc (mm)										
DR (mm)	Dc (mm) XNKU 06...									
	1	3,9	4,4	4,9	5,6	5,8	6,2	6,4	7,0	7,1
2	5,3	6,0	6,8	7,7	8,1	8,7	8,9	9,8	10,0	11,0
3	6,2	7,1	8,1	9,3	9,8	10,5	10,8	11,9	12,1	13,4

Note: Recommended for L ≤ 4 Dc for extra long tool this step and side cut must be reduced.

PENTA HIFEED 06320

Proprietary milling line

A

MILLING

Overview

Face milling

Hifeed milling

Shoulder milling

Profile milling

Hardmill

Center & Chamfer

Spot face

Spare Parts

Technical Data

End Mills

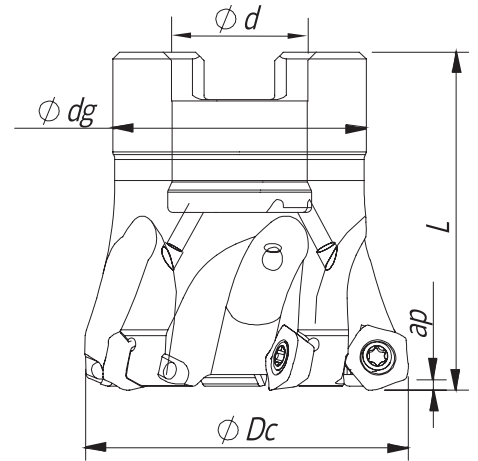

Arbor Mounting
 $K_r=20^\circ$ | $\gamma_p=14^\circ$ | $R_p=2,5$

Order code Código	Reference Referência Referencia		Dimensions Dimensões Dimensiones (mm)				Kg	Specifications		Insert	Stock
			ϕDc	ϕd	ϕdg	L		A_p max (mm)	Arbor Type		
181129300	040A06320-05-14-016040	5	40	16	30	40	0,15	1,0	A	POKT 0403...	
181129400	050A06320-06-14-022045	6	50	22	40	45	0,19	1,0	A	POKT 0403...	
181129500	052A06320-06-14-022045	6	52	22	40	45	0,29	1,0	A	POKT 0403...	
181129600	063A06320-07-14-027050	7	63	27	48	50	0,50	1,0	A	POKT 0403...	
181131300	066A06320-07-14-027050	7	66	27	48	50	0,55	1,0	A	POKT 0403...	

Stock item | Produto de stock | Itens de stock

Available under request (see page A-9) | Disponível sobre consulta (consulte a página A-9) | Disponible bajo consulta (mire pagina A-9)

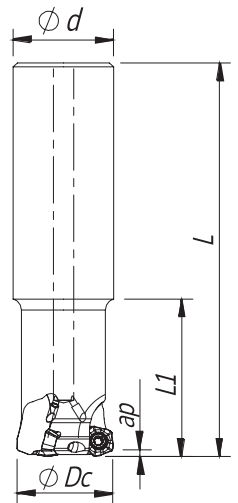

Cylindrical Shank
 $K_r=20^\circ$ | $\gamma_p=14^\circ$ | $R_p=2,5$

Order code Código	Reference Referência Referencia		Dimensions Dimensões Dimensiones (mm)				Kg	Specifications		Insert	Stock
			ϕDc	ϕd	L	L1		A_p max (mm)	Arbor Type		
181147200	020E06320-02-14-020130	2	20	20	130	40	0,38	1,0	A	POKT 0403...	
181131000	025E06320-03-14-025150	3	25	25	150	40	0,41	1,0	A	POKT 0403...	
181131100	032E06320-05-14-032180	5	32	32	180	50	0,56	1,0	A	POKT 0403...	
181131200	040E06320-05-14-032180	5	40	32	180	50	0,70	1,0	A	POKT 0403...	

Stock item | Produto de stock | Itens de stock

Available under request (see page A-9) | Disponível sobre consulta (consulte a página A-9) | Disponible bajo consulta (mire pagina A-9)

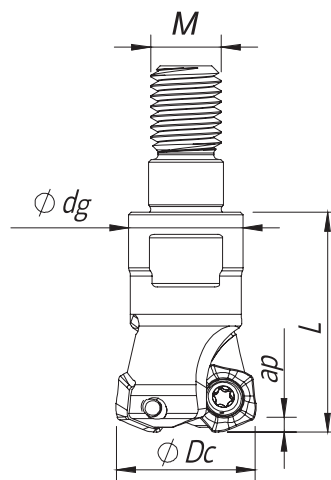
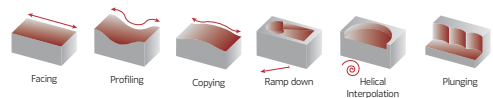

Threaded Coupling
 $K_r=20^\circ$ | $\gamma_p=14^\circ$ | $R_p=2,5$

Order code Código	Reference Referência Referencia		Dimensions Dimensões Dimensiones (mm)				Kg	Specifications		Insert	Stock
			ØDc	ØM	Ødg	L		Ap max (mm)			
181113500	016R06320-02-14-M08025	2	16	M08	13	25	0,02	1,0	POKT 0403...		
181113600	020R06320-02-14-M10025	2	20	M10	18	25	0,05	1,0	POKT 0403...		
181113700	025R06320-03-14-M12028	3	25	M12	21	28	0,07	1,0	POKT 0403...		
181129100	032R06320-05-14-M16035	5	32	M16	29	35	0,17	1,0	POKT 0403...		
181129200	035R06320-05-14-M16035	5	35	M16	29	35	0,19	1,0	POKT 0403...		
181130900	042R06320-05-14-M16035	5	42	M16	29	35	0,23	1,0	POKT 0403...		

Stock item | Produto de stock | Itens de stock

Available under request (see page A-9) | Disponível sobre consulta (consulte a página A-9) | Disponible bajo consulta (mire pagina A-9)

POKT 0403... || Inserts | Pastilhas | Plaquetas

POKT-MP



POKT-MP

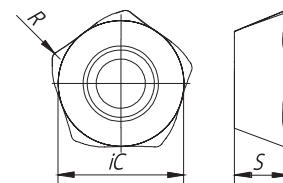

	⁽²⁾ Grade code	P				K		Dimensions Dimensões Dimensiones (mm)		
		PVD				PVD				
		G1	G4	P3	G6	G1	G4	iC	S	R
⁽¹⁾ Geometry code	ISO Reference	PH7910	PH7920	PH7930	PH7740	PH7910	PH7920			
1112365	POKT 040305 ZDSR-MP							7,00	3,00	0,50

First choice | Primeira opção | 1ª opción

Stock item | Produto de stock | Itens de stock

Available under request (see page A-9) | Disponível sobre consulta (consulte a página A-9) | Disponible bajo consulta (mire pagina A-9)

Insert order code = (1) Geometry Code + (2) Grade Code

PENTA HIFEED 06320

SPARE PARTS Complementos | Repuestos

Cutter ØDc	Order separately			Order separately		
	Insert Screw	Key (Torx)	Key (Torx - Nm)	Torque Value	Screw	DIN 6368 Wrench
R06320 - 16-42	P0250503	XT08	DT0812	1,20	-	-
E06320 - 25-40	P0250503	XT08	DT0812	1,20	-	-
A06320 - 40-60	P0250503	XT08	DT0812	1,20	-	-

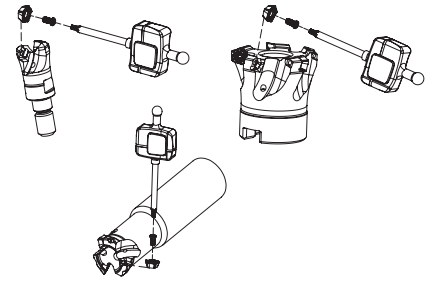

Note: The toolholder is supplied with the XT/PT key. To order the DT key please check the page A-241.
Check the procedures for the clamping screws on the page A-241.

GRADES SELECTION GUIDE | Guia para selecção de graus | Tabla para selección de calidades

ISO	PSM	Material	HB (Brinell)	Grades			
				← Wear Resistance			Toughness →
				PH7910	PH7920	PH7930	PH7740
P	1	Unalloyed Steel	125-220	●	●	●	●
	2	Low-Alloyed Steel	220-280	●	●	●	●
	3	High-Alloyed Steel	280-380	●	●	●	●
K	7	Malleable Cast Iron	130-230	●	●		
	8	Grey Cast Iron	180-245	●	●		
	9	Nodular Cast iron	160-250	●	●		

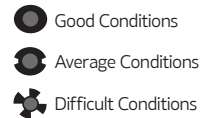

RECOMMENDED CUTTING CONDITIONS | Condições de corte recomendadas | Condiciones de corte recomendables

ISO	PSM	Material	HB (Brinell)	Vc (m/min)				Feed fz (mm/t)
				← Wear Resistance			Toughness →	
				PH7910	PH7920	PH7930	PH7740	
P	1	Unalloyed Steel	125-220	180-250	180-240	160-220	140-200	0,50-1,50
	2	Low-Alloyed Steel	220-280	160-230	160-220	140-200	130-180	0,50-1,51
	3	High-Alloyed Steel	280-380	140-220	140-210	120-190	100-170	0,50-1,52
K	7	Malleable Cast Iron	130-230	180-300	160-260	-	-	0,50-1,53
	8	Grey Cast Iron	180-245	160-250	140-240	-	-	0,50-1,54
	9	Nodular Cast iron	160-250	150-200	120-200	-	-	0,50-1,55

(Note 1) Cutting conditions $a_e/D_c=70\%$.

(Note 2) It's possible to occur vibrations in certain cases. Please reduce depth of cut and / or reduce cutting conditions in following cases:

- When using long shank;
- When using long tool overhang with arbor type;
- When application has poor clamping rigidity or when using a low rigidity machine.

(Note 3) PH5... and PH8... can be used wet or dry. PH7... use only air.

PROGRAMMING DATA | Dados para programação | Datos para la programación

Insert	Programming Data			
	Rp	X	b	a_e
POKT 0403...	2,5	1,2	4,3	4,0

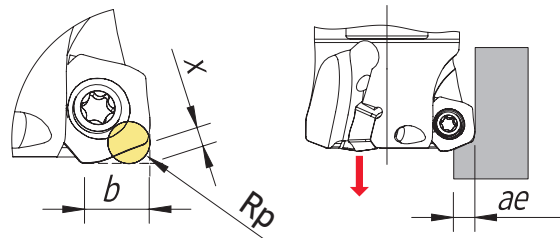

RAMPING AND HELICAL INTERPOLATION

Descida em rampa e interpolação helicoidal | Bajada en rampa e interpolación circular

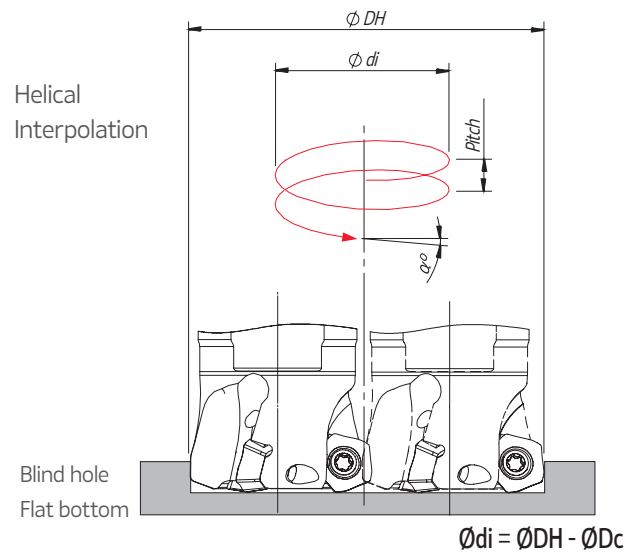
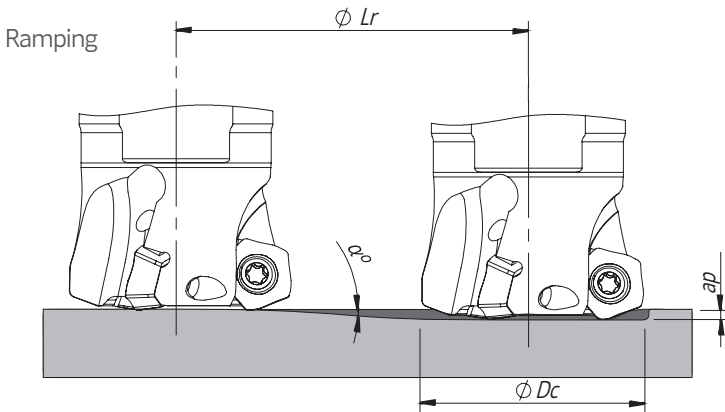

$$\phi di = \phi DH - \phi Dc$$

ØDc	Ramping			Helical Interpolation		
	Max Ramp a°	Max ap	Min Lr	ØDHmin	ØDHmax	Max Pitch/Rev.
16	15	1,0	3,7	23,4	-	6
				-	30,0	11
20	9,0	1,0	6,3	31,4	-	5
				-	38,0	8
25	5,0	1,0	11,4	41,4	-	4
				-	48,0	6
32	3,4	1,0	16,8	55,4	-	4
				-	62,0	5
35	3,0	1,0	19,1	61,4	-	4
				-	68,0	5
40	2,0	1,0	28,6	71,4	-	3
				-	78,0	4
42	2,0	1,0	28,6	84,0	-	4
				-	82,0	4
50	2,0	1,0	28,6	91,4	-	4
				-	98,0	5
52	2,0	1,0	28,6	95,4	-	4
				-	102,0	5
63	2,0	1,0	28,6	117,4	-	5
				-	124,0	6
66	1,8	1,0	31,8	123,4	-	5
				-	130,0	6

Note: During helical interpolation do not exceed max Pitch.

PLUNGING | Mergulho | Plunge

L ≤ 3Dc	L > 3Dc	S max.
fz (mm/t)		
0,08-0,15	0,05 - 0,10	$S_{max} = \sqrt{Dc \cdot Dr - Dr^2}$

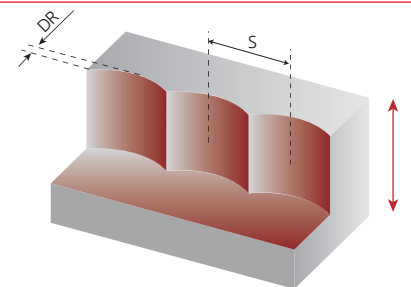

S max and DR corresponding cutting diameter Dc (mm)											
DR (mm)	Dc (mm) POKT 04...										
	16	20	25	32	35	40	42	50	52	63	66
1,0	3,9	4,4	4,9	5,7	5,8	6,2	6,4	7,0	7,1	7,9	8,1
2,0	5,3	6,0	6,8	7,7	8,1	8,7	8,9	9,8	10,0	11,0	11,3
3,0	6,2	7,1	8,1	9,3	9,8	10,5	10,8	11,9	12,1	13,4	13,7
4,0	6,9	8,0	9,2	10,6	11,1	12,0	12,3	13,6	13,9	15,4	15,7

Note: Recommended for L ≤ 4 Dc for extra long tool this step and side cut must be reduced.

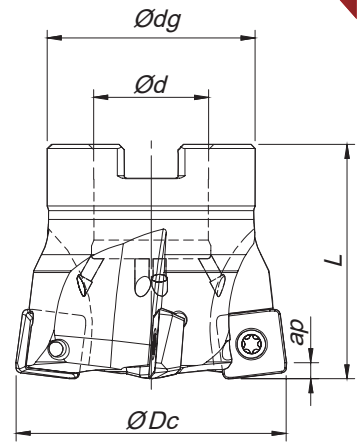

Arbor Mounting

$K_r=10^\circ$ | $\gamma_p=+2^\circ$ | $\gamma_f=+2^\circ$ | $R_p=2,0$

Order code Código	Reference Referência Referencia		Dimensions Dimensões Dimensiones (mm)				Kg	Specifications		Insert Pastilha Inserto	Stock
			$\varnothing Dc$	$\varnothing d$	$\varnothing dg$	L		Ap max (in)	Arbor Type		
181149800	040A06410-05-02-016040	5	40	16	30	40	0,157	1,00	A	SO...0803...	
181153200	050A06410-06-02-022045	6	50	22	40	45	0,312	1,00	A	SO...0803...	
181149900	052A06410-06-02-022045	6	52	22	40	45	0,331	1,00	A	SO...0803...	

Stock item | Produto de stock | Itens de stock

Available under request | Disponível sobre consulta | Disponible bajo consulta

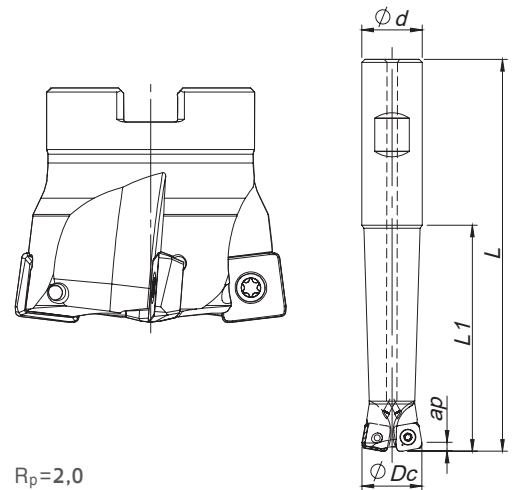

Weldon Shank

$K_r=10^\circ$ | $\gamma_p=+2^\circ$ | $\gamma_f=+2^\circ$ | $R_p=2,0$

Order code Código	Reference Referência Referencia		Dimensions Dimensões Dimensiones (mm)				Kg	Specifications		Insert Pastilha Inserto	Stock
			$\varnothing Dc$	$\varnothing d$	L	L1		Ap max (mm)	Arbor Type		
181076300	020W06410-02-02-020130	2	20	20	130	75	0,360	1,00	SO...0803...		
181080900	020W06410-02-02-020190	2	20	20	190	110	0,340	1,00	SO...0803...		
181076400	025W06410-03-02-025140	3	25	25	140	80	0,410	1,00	SO...0803...		
181081100	025W06410-03-02-025200	3	25	25	200	130	0,570	1,00	SO...0803...		
181076500	032W06410-04-02-032150	4	32	32	150	90	0,760	1,00	SO...0803...		
181081300	032W06410-04-02-032200	4	32	32	200	130	1,010	1,00	SO...0803...		

Stock item | Produto de stock | Itens de stock

Available under request | Disponível sobre consulta | Disponible bajo consulta

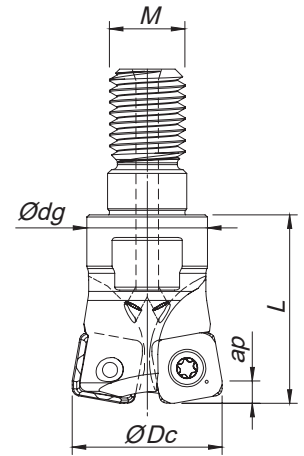
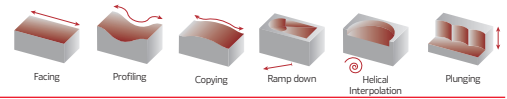

Threaded Coupling

$K_r=10^\circ$ | $\gamma_p=+2^\circ$ | $\gamma_f=+2^\circ$ | $R_p=2,0$

Order code Código	Reference Referência Referencia		Dimensions Dimensões Dimensiones (mm)				Kg	Specifications	Insert Pastilha Inserto	Stock
			ØDc	ØM	Ødg	L		Ap max (mm)		
181071900	020R06410-02-02-M10025		20	M10	16	25	0,040	1,00	SO...0803...	
181076600	025R06410-03-02-M12028		25	M12	21	28	0,070	1,00	SO...0803...	
181076700	032R06410-04-02-M16035		32	M16	29	35	0,160	1,00	SO...0803...	
181076800	035R06410-04-02-M16035		35	M16	29	35	0,180	1,00	SO...0803...	
181076900	042R06410-05-02-M16035		42	M16	29	35	0,220	1,00	SO...0803...	

Stock item | Produto de stock | Itens de stock

Available under request | Disponível sobre consulta | Disponible bajo consulta

SO...0803... || Inserts | Pastilhas | Plaquetas

SOEW



SOET



SOEW

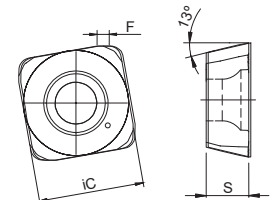

SOET

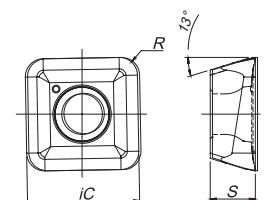

Geometry code	ISO Reference	P			M		K			S		Dimensions Dimensões Dimensiones (mm)			
		PVD			PVD		PVD			PVD		iC	S	R	F
		X5	T1	G6	X9	G6	X5	T1	G6	X9	G6				
1111884	SOEW 080310 S											8,60	3,47	1,0	1,0
1112149	SOET 080315-MS											8,60	3,47	1,5	-

First choice | Primeira opção | 1ª opción

Stock item | Produto de stock | Itens de stock

Available under request | Disponível sobre consulta | Disponible bajo consulta

Insert order code = (1) Geometry Code + (2) Grade Code

HIFEED 06410

SPARE PARTS | Complementos | Repuestos

Cutter ØDc	Insert Screw	Key (Torx)	Order separately	
			Key (Torx - Nm)	Torque Value
A06410 - 40 - 52	P0300800	XT09	DT0914	1,4
R06410 - 20 - 42	P0300800	XT09	DT0914	1,4
W06410 - 20 - 32	P0300800	XT09	DT0914	1,4

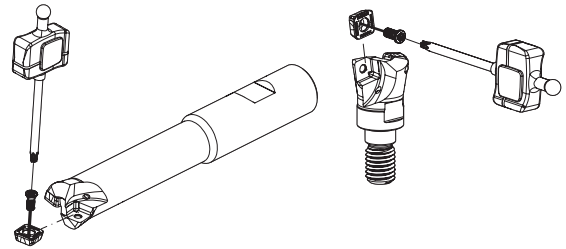

PROGRAMMING DATA | Dados para programação | Datos para la programación

Insert	Programming Data			
	Rp	X	b	ae
SO... 0803..	2,0	0,8	6,8	6,3

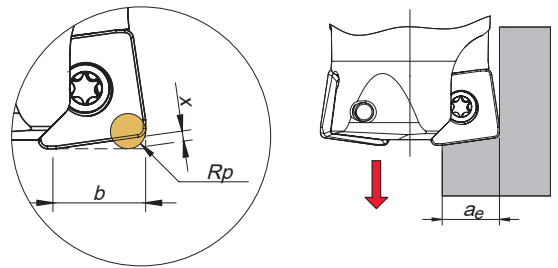

GRADES SELECTION GUIDE | Guia para selecção de graus | Tabla para selección de calidades

ISO	PSM	Material	HB (Brinell)	Grades			
				← Wear Resistance		Toughness →	
				PHP910	PHP920	PHH930	PH7740
P	1	Unalloyed Steel	125-220	●	●	●	●
	2	Low-Alloyed Steel	220-280	✓	✓		✓
	3	High-Alloyed Steel	280-380	✓	✓		✓
M	4	SS - Ferritic / Martensitic	200-330			✓	✓
	5	SS - Austenitic	200-330			✓	✓
	6	SS - Austenitic-ferritic (Duplex)	230-260			✓	✓
K	7	Malleable Cast Iron	130-230	✓	✓		
	8	Grey Cast Iron	180-245	✓	✓		
	9	Nodular Cast iron	160-250	✓	✓		
S	11	Heat Resistant Super Alloys	200-320			✓	✓

- Good Conditions
- Average Conditions
- Difficult Conditions

RECOMMENDED CUTTING CONDITIONS | Condições de corte recomendadas | Condiciones de corte recomendables

ISO	PSM	Material	HB (Brinell)	Vc (m/min)				Feed fz (mm/t)	
				← Wear Resistance		Toughness →		SOEW 08...	SOET 08...
				PHP910	PHP920	PHH930	PH7740		
P	1	Unalloyed Steel	125-220	180-250	180-250	-	140-200	0,40-1,80	0,40-1,80
	2	Low-Alloyed Steel	220-280	160-240	160-230	-	130-180	0,40-1,80	-
	3	High-Alloyed Steel	280-380	140-230	140-220	-	100-170	0,40-1,50	-
M	4	SS - Ferritic / Martensitic	200-330	-	-	140-210	130-180	-	0,40-1,30
	5	SS - Austenitic	200-330	-	-	120-170	110-160	-	0,40-1,30
	6	SS - Austenitic-ferritic (Duplex)	230-260	-	-	100-150	90-150	-	0,10-1,00
K	7	Malleable Cast Iron	130-230	180-300	160-270	-	-	0,40-1,80	0,40-1,80
	8	Grey Cast Iron	180-245	160-250	140-250	-	-	0,40-1,80	-
	9	Nodular Cast iron	160-250	150-210	120-210	-	-	0,40-1,80	-
S	11	Heat Resistant Super Alloys	200-320			30-110	30-100	-	0,40-1,00

(Note 1) Cutting conditions $a_e/D_c=70\%$.

(Note 2) It's possible to occur vibrations in certain cases. Please reduce depth of cut and / or reduce cutting conditions in following cases:

- When using long shank;
- When using long tool overhang with arbor type;
- When application has poor clamping rigidity or when using a low rigidity machine.

(Note 3) PH5... and PH8... can be used wet or dry. PH7... use only air.

(Note 4) It's possible to occur vibrations in certain cases. Please reduce depth of cut and / or reduce cutting conditions in following cases:

- When using long shank;
- When using long tool overhang with arbor type;
- When application has poor clamping rigidity or when using a low rigidity machine.

CHIP-BREAKER SELECTION GUIDE | Guia para aplicações do quebra- aparas | Guía para aplicación del rompevirutas

ISO	PSM	Material	HB (Brinell)	Chip-Breaker Application	
				1st choice	Difficult Operations
P	1	Unalloyed Steel	125-220	SOET 08...	SOEW 08...
	2	Low-Alloyed Steel	220-280	SOEW 08...	-
	3	High-Alloyed Steel	280-380	SOEW 08...	-
M	4	SS - Ferritic / Martensitic	200-330	SOET 08...	-
	5	SS - Austenitic	200-330	SOET 08...	-
	6	SS - Austenitic-ferritic (Duplex)	230-260	SOET 08...	-
K	7	Malleable Cast Iron	130-230	SOET 08...	SOEW 08...
	8	Grey Cast Iron	180-245	SOEW 08...	-
	9	Nodular Cast iron	160-250	SOEW 08...	-
S	11	Heat Resistant Super Alloys	200-320	SOET 08...	-



HIFEED 06410

RAMPING AND HELICAL INTERPOLATION

Descida em rampa e interpolação helicoidal | Bajada en rampa e interpolación circular

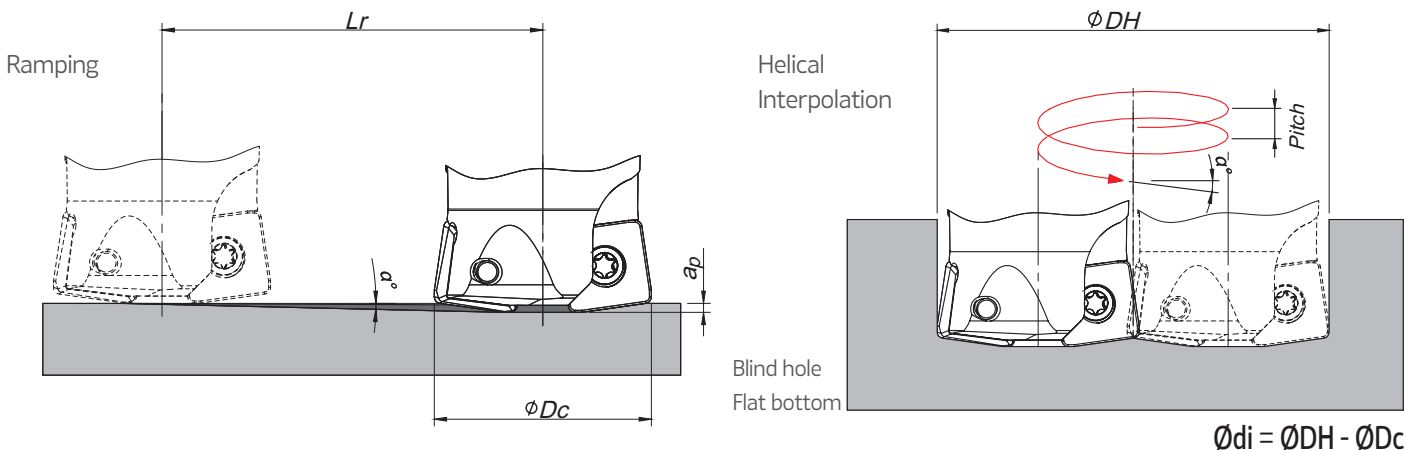

ϕD_c	Ramping			Helical Interpolation		
	Max Ramp a_p°	Max a_p	Min L_r	ϕDH_{min}	ϕDH_{max}	Max Pitch/Rev.
20	15	1,0	3,2	26,4 -	- 38,0	6 17
25	9,5	1,0	6,0	36,4 -	- 48,0	5 12
32	5,5	1,0	10,4	50,4 -	- 62,0	5 9
35	4,5	1,0	12,7	56,4 -	- 68,0	5 8
40	3,5	1,0	16,3	66,4 -	80	5 7
42	3,5	1,0	16,3	70,4 -	- 82,0	5 7
50	3,5	1,0	16,3	86,4 -	- 100,0	6 9
52	3,5	1,0	16,3	90,4 -	- 104,0	7 9

Note: During helical interpolation do not exceed max Pitch.

PLUNGING | Mergulho | Plunge

L ≤ 3Dc	L > 3Dc	S max.
f _z (mm/t)		
0,08-0,15	0,05-0,10	$S_{max} = \sqrt{D_c \cdot DR \cdot DR^2}$

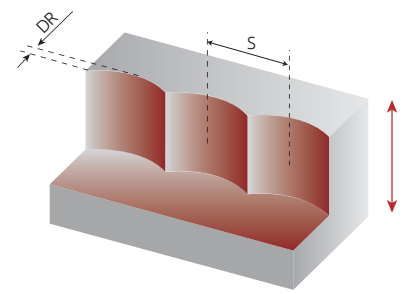

S max and DR corresponding cutting diameter Dc (mm)								
DR (mm)	Dc (mm)							
	20	25	32	35	40	42	50	52
1,0	4,4	4,9	5,6	5,8	6,2	6,4	7,0	7,1
2,0	6,0	6,8	7,7	8,1	8,7	8,9	9,8	10,0
3,0	7,1	8,1	9,3	9,8	10,5	10,8	11,9	12,1
4,0	8,0	9,2	10,6	11,1	12,0	12,3	13,6	13,9
5,0	8,7	10,0	11,6	12,2	13,2	13,6	15,0	15,3
6,0	9,2	10,7	12,5	13,2	14,3	14,7	16,2	16,6

Note: Recommended for L ≤ 4 Dc for extra long tool this step and side cut must be reduced.

A

MILLING

Overview

Face milling

Hifeed milling

Shoulder milling

Profile milling

Hardmill

Center & Chamfer

Spot face

Spare Parts

Technical Data

End Mills

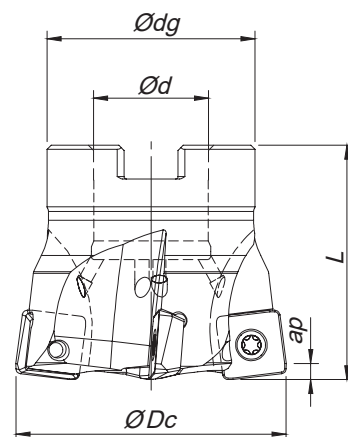
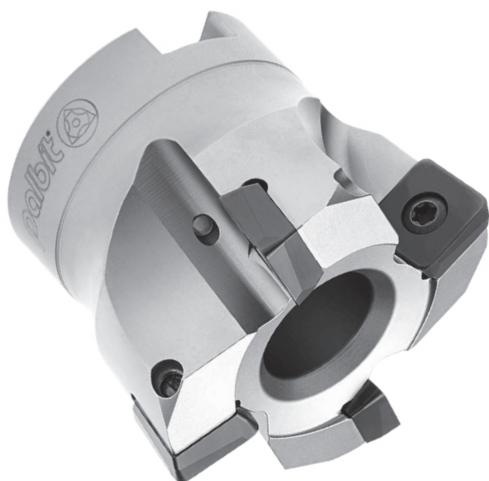

Arbor Mounting

$K_r=10^\circ$ | $\gamma_p=+5^\circ$ | $R_p=2,5$

Order code Código	Reference Referência Referencia		Dimensions Dimensões Dimensiones (mm)				Kg	Specifications		Insert Pastilha Inserto	Stock
			ØDc	Ød	Ødg	L		Ap max (mm)	Arbor Type		
181069100	050A06690-04-05-022045	4	50	22	40	45	0,274	1,50	A	SO...13M5...	
181111100	050A06690-05-05-022045	5	50	22	40	45	0,272	1,50	A	SO...13M5...	
181029800	052A06690-04-05-022045	4	52	22	40	45	0,290	1,50	A	SO...13M5...	
181033500	063A06690-05-05-027050	5	63	27	48	50	0,500	1,50	A	SO...13M5...	
181029900	066A06690-05-05-027050	5	66	27	48	50	0,550	1,50	A	SO...13M5...	
181030000	080A06690-06-05-027050	6	80	27	60	50	0,955	1,50	A	SO...13M5...	
181113100	100A06690-08-05-032050	8	100	32	70	50	1,500	1,50	A	SO...13M5...	

Stock item | Produto de stock | Itens de stock

Available under request (see page A-9) | Disponível sobre consulta (consulte a página A-9) | Disponible bajo consulta (mire pagina A-9)

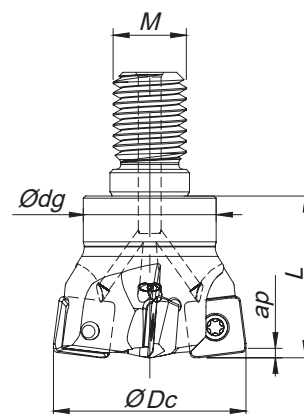

Threaded Coupling

$K_r=10^\circ$ | $\gamma_p=+5^\circ$ | $R_p=2,5$

Order code Código	Reference Referência Referencia		Dimensions Dimensões Dimensiones (mm)				Kg	Specifications		Insert Pastilha Inserto	Stock
			ØDc	ØM	Ødg	L		Ap max (mm)	Arbor Type		
181038700	032R06690-03-05-M16035	3	32	M16	29	35	0,145	1,50	SO...13M5		
181064600	035R06690-03-05-M16035	3	35	M16	29	35	0,163	1,50	SO...13M5		
181038800	042R06690-04-05-M16035	4	42	M16	29	35	0,194	1,50	SO...13M5		

Stock item | Produto de stock | Itens de stock

Available under request (see page A-9) | Disponível sobre consulta (consulte a página A-9) | Disponible bajo consulta (mire pagina A-9)

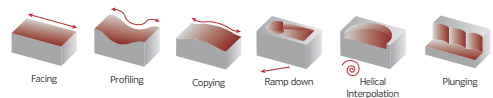

SO...13M5... || Inserts | Pastilhas | Plaquetas

SOEW



SOEW-MD **NEW**



SOEW | SOEW-MD

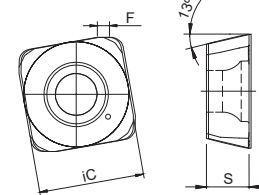

SOET



SOET

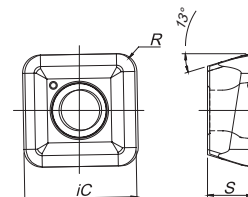

(1) Geometry code	(2) Grade code	P			M			K			S		Dimensions Dimensões Dimensiones (mm)			
		PVD			PVD			PVD			PVD		iC	S	R	F
		X5	T1	G6	P3	X9	G6	X5	T1	G6	X9	G6				
1111906	SOEW 13M510 S	⊗	⊗	⊗				⊗	⊗	⊗			12,43	5,00	1,20	1,0
1112813	SOEW 13M510-MD		⊗						⊗				12,43	5,00	1,20	1,0
1112147	SOET 13M520-MS			⊗	⊗	⊗	⊗			⊗	⊗	⊗	12,43	5,00	2,0	-

⊗ First choice | Primeira opção | 1ª opción ⊗ Stock item | Produto de stock | Itens de stock ○ Available under request (see page A-9) | Disponível sobre consulta (consulte a página A-9) | Disponible bajo consulta (mire página A-9) Insert order code = (1) Geometry Code + (2) Grade Code
 ⊕ Stock available until sold out | Stock disponível até acabar o stock | Stock disponible hasta acabar el stock

SPARE PARTS || Complementos | Repuestos

Cutter ØDc	Order separately				
	Insert Screw	Key (Torx)	Key (Torx - Nm)	Torque Value	Retaining Screw
R06690 - 32 - 42	P0401200	XT15	DT1530	3	-
A06690 - 50 - 80	P0401200	XT15	DT1530	3	-
A06690 - 100	P0401200	XT15	DT1530	3	D1603500

Note: The toolholder is supplied with the XT/PT key. To order the DT key please check the page A-241.
 Check the procedures for the clamping screws on the page A-241.

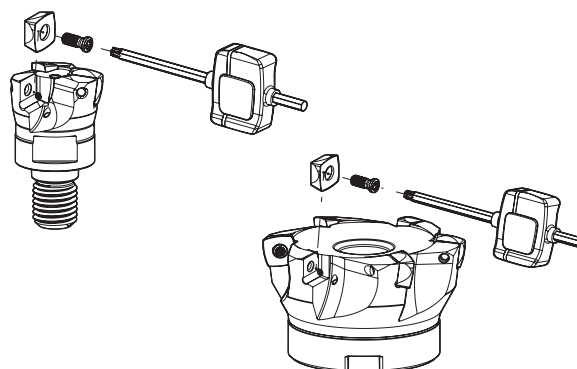

A
MILLING
Overview
Face milling
Hifeed milling
Shoulder milling
Profile milling
Hardmill
Center & Chamfer
Spot face
Spare Parts
Technical Data
End Mills

GRADES SELECTION GUIDE | Guia para selecção de graus | Tabla para selección de calidades

ISO	PSM	Material	HB (Brinell)	Grades			
				← Wear Resistance			Toughness →
				PHP910	PHP920	PHH930	PH7740
P	1	Unalloyed Steel	125-220	●	●	●	●
	2	Low-Alloyed Steel	220-280	●	●		●
	3	High-Alloyed Steel	280-380	●	●		●
M	4	SS - Ferritic / Martensitic	200-330			●	●
	5	SS - Austenitic	200-330			●	●
	6	SS - Austenitic-ferritic (Duplex)	230-260			●	●
K	7	Malleable Cast Iron	130-230	●	●		●
	8	Grey Cast Iron	180-245	●	●		●
	9	Nodular Cast iron	160-250	●	●		●
S	11	Heat Resistant Super Alloys	200-320			●	●

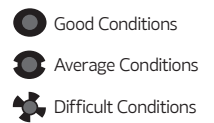

RECOMMENDED CUTTING CONDITIONS | Condições de corte recomendadas | Condiciones de corte recomendables

ISO	PSM	Material	HB (Brinell)	Vc (m/min)				Feed fz (mm/t)		
				← Wear Resistance			Toughness →			
				PHP910	PHP920	PHH930	PH7740	SOEW S	SOEW MD	SOET MS
P	1	Unalloyed Steel	125-220	180-250	180-250	-	140-200	0,50-2,10	0,50-2,20	0,50-2,10
	2	Low-Alloyed Steel	220-280	160-240	160-230	-	130-180	0,50-2,10	0,50-2,20	-
	3	High-Alloyed Steel	280-380	140-230	140-220	-	100-170	0,50-2,00	0,50-2,10	-
M	4	SS - Ferritic / Martensitic	200-330	-	-	140-210	130-180	-	-	0,50-1,80
	5	SS - Austenitic	200-330	-	-	120-170	110-160	-	-	0,50-1,80
	6	SS - Austenitic-ferritic (Duplex)	230-260	-	-	100-150	90-150	-	-	0,50-1,50
K	7	Malleable Cast Iron	130-230	180-300	160-270	-	140-220	0,50-2,10	0,50-2,20	0,50-2,10
	8	Grey Cast Iron	180-245	160-250	140-250	-	120-210	0,50-2,10	0,50-2,20	-
	9	Nodular Cast iron	160-250	150-210	120-210	-	100-190	0,50-2,10	0,50-2,20	-
S	11	Heat Resistant Super Alloys	200-320	-	-	30-110	30-100	-	-	0,40-1,30

(Note 1) Cutting conditions $a_e/D_c=70\%$.

(Note 2) It's possible to occur vibrations in certain cases. Please reduce depth of cut and / or reduce cutting conditions in following cases:

- When using long shank;
- When using long tool overhang with arbor type;
- When application has poor clamping rigidity or when using a low rigidity machine.

(Note 3) It's possible to occur vibrations in certain cases. Please reduce depth of cut and / or reduce cutting conditions in following cases:

- When using long shank;
- When using long tool overhang with arbor type;
- When application has poor clamping rigidity or when using a low rigidity machine.

CHIP-BREAKER SELECTION GUIDE | Guia para aplicações do quebra- aparas | Guía para aplicación del rompevirutas

ISO	PSM	Material	HB (Brinell)	Chip-Breaker Application	
				1st choice	Difficult Operations
P	1	Unalloyed Steel	125-220	SOEW-MD	SOEW-S
	2	Low-Alloyed Steel	220-280	SOEW-MD	SOEW-S
	3	High-Alloyed Steel	280-380	SOEW-MD	SOEW-S
M	4	SS - Ferritic / Martensitic	200-330	SOET-MS	-
	5	SS - Austenitic	200-330	SOET-MS	-
	6	SS - Austenitic-ferritic (Duplex)	230-260	SOET-MS	-
K	7	Malleable Cast Iron	130-230	SOET-MS	SOEW-S
	8	Grey Cast Iron	180-245	SOEW-MD	SOEW-S
	9	Nodular Cast iron	160-250	SOEW-MD	SOEW-S
S	11	Heat Resistant Super Alloys	200-320	SOET-MS	-

PROGRAMMING DATA | Dados para programação | Datos para la programación

Insert	Programming Data			
	Rp	X	b	ae
SO... 13M5..	2,5	1,1	10,5	10,0

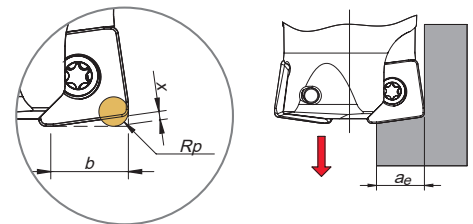

HIFEED 06690

RAMPING AND HELICAL INTERPOLATION

Descida em rampa e interpolação helicoidal | Bajada en rampa e interpolación circular

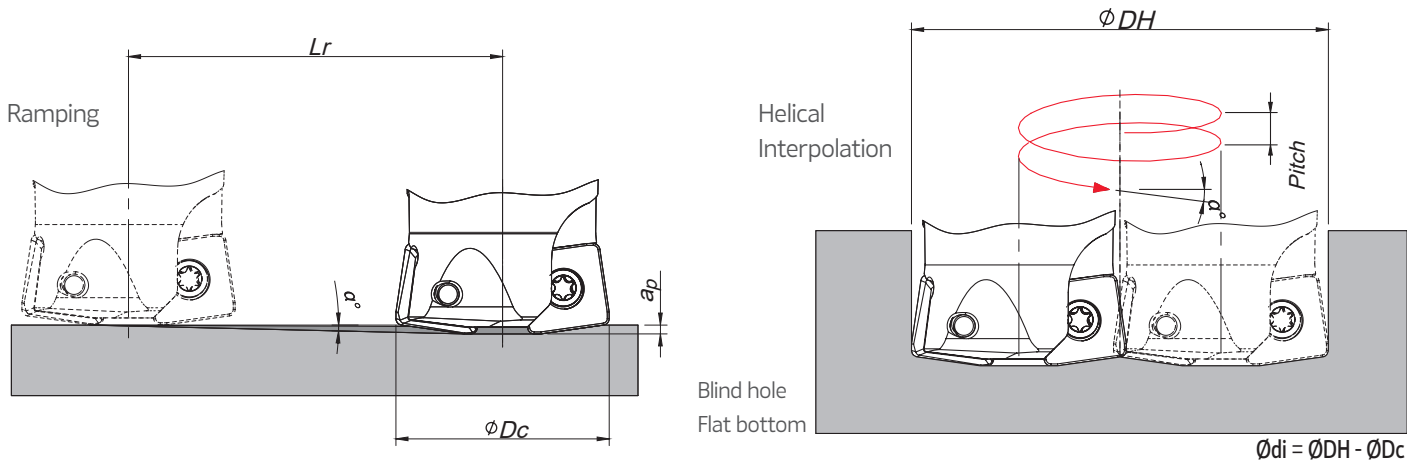

ϕDc	Ramping			Helical Interpolation		
	Max Ramp a°	Max a_p	Min L_r	ϕDH_{min}	ϕDH_{max}	Max Pitch/Rev.
32	10,0	1,5	6,0	43 -	- 62,0	6 16
35	9,0	1,5	9,5	49 -	- 68,0	6 16
42	6,4	1,5	13,4	63 -	- 82,0	7 14
50	4,3	1,5	19,9	79 -	- 98,0	6 11
52	4,0	1,5	21,5	83 -	- 102,0	6 10
63	3,0	1,5	28,6	105 -	- 124,0	6 10
66	2,6	1,5	33,0	111 -	- 130,0	6 9
80	2,0	1,5	43,0	139 -	- 158,0	6 8
100	1,0	1,5	85,9	179 -	- 198,0	4 5

Note: During helical interpolation do not exceed max Pitch.

PLUNGING | Mergulho | Plunge

L ≤ 3Dc	L > 3Dc	S max.
f _z (mm/t)		
0,10-0,20	0,07-0,14	$S_{max} = \sqrt{D_c \cdot DR - DR^2}$

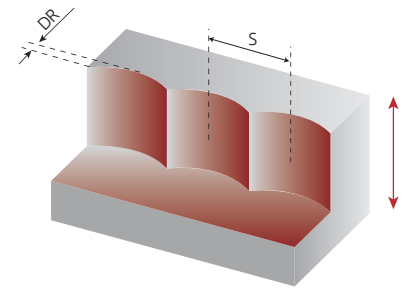

S max and DR corresponding cutting diameter Dc (mm)									
DR (mm)	Dc (mm)								
	32	35	42	50	52	63	66	80	
1,0	5,6	5,8	6,4	7,0	7,1	7,9	8,1	8,9	
2,0	7,7	8,1	8,9	9,8	10,0	11,0	11,3	12,5	
3,0	9,3	9,8	10,8	11,9	12,1	13,4	13,7	15,2	
4,0	10,6	11,1	12,3	13,6	13,9	15,4	15,7	17,4	
5,0	11,6	12,2	13,6	15,0	15,3	17,0	17,5	19,4	
6,0	12,5	13,2	14,7	16,2	16,6	18,5	19,0	21,1	
7,0	13,2	14,0	15,7	17,3	17,7	19,8	20,3	22,6	
8,0	13,9	14,7	16,5	18,3	18,8	21,0	21,5	24,0	
9,0	14,4	15,3	17,2	19,2	19,7	22,0	22,6	25,3	
10,0	14,8	15,8	17,9	20,2	20,5	23,0	23,7	26,5	

Note: Recommended for L ≤ 4 Dc for extra long tool this step and side cut must be reduced.

A

MILLING

Overview

Face milling

Hifeed milling

Shoulder milling

Profile milling

Hardmill

Center & Chamfer

Spot face

Spare Parts

Technical Data

End Mills

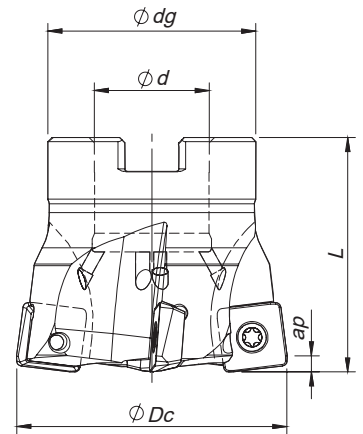
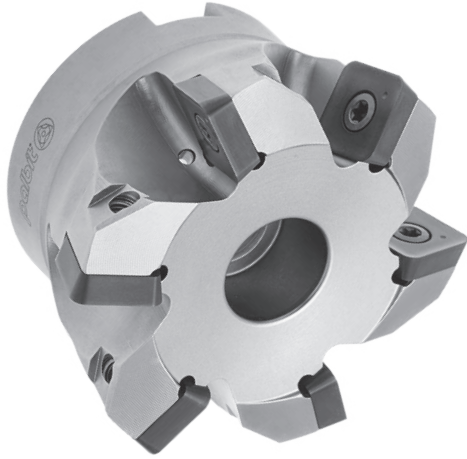

Arbor Mounting

$\kappa_r=15^\circ$ | $\gamma_p=+2^\circ$ | $R_p=4,5$

Order code Código	Reference Referência Referencia		Dimensions Dimensões Dimensiones (mm)				Kg	Specifications		Insert Pastilha Inserto	Stock
			ϕDc	ϕd	ϕdg	L		Ap max (mm)	Arbor Type		
181100400	063A06815-05-02-027050		63	27	48	50	0,460	3,50	A	SO...1605...	
181081900	066A06815-05-02-027050		66	27	48	50	0,500	3,50	A	SO...1605...	
181082000	080A06815-06-02-027050		80	27	60	50	0,900	3,50	A	SO...1605...	
181082100	100A06815-08-02-032050		100	32	80	50	1,600	3,50	B	SO...1605...	
181082200	125A06815-10-02-040063		125	40	90	63	2,900	3,50	B	SO...1605...	
181082300	160A06815-12-02-U040063		160	40	110	63	4,400	3,50	C	SO...1605...	

Stock item | Produto de stock | Itens de stock

Available under request (see page A-9) | Disponível sobre consulta (consulte a página A-9) | Disponible bajo consulta (mire pagina A-9)

SO...1605... || Inserts | Pastilhas | Plaquetas

SOEW



SOEW

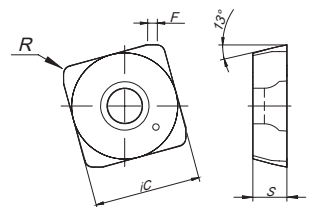

SOET



SOET

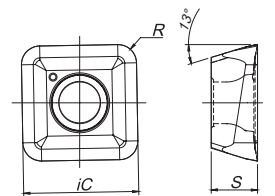

(1) Geometry code	ISO Reference	P					M			K					S		Dimensions Dimensões Dimensiones (mm)			
		PVD					PVD			PVD					PVD		iC	S	R	F
		X5	G1	T1	G4	G6	X9	P3	G6	X5	G1	T1	G4	G6	X9	G6				
1111907	SOEW 160512 S																16,40	5,26	1,20	1,50
1112221	SOET 160520-MS																16,40	5,26	2,00	-

First choice | Primeira opção | 1ª opción

Stock item | Produto de stock | Itens de stock

Available under request (see page A-9) | Disponível sobre consulta (consulte a página A-9) | Disponible bajo consulta (mire pagina A-9)

Insert order code = (1) Geometry Code + (2) Grade Code

Stock available until sold out | Stock disponível até acabar o stock | Stock disponible hasta acabar el stock

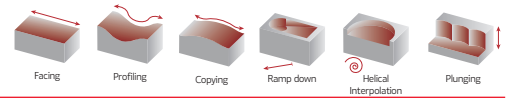

SPARE PARTS | Complementos | Repuestos

Cutter ØDc	Insert Screw	Key (Torx)	Order separately		Order separately	
			Key (Torx - Nm)	Torque Value	Screw	DIN 6368 Wrench
A06815 - 63-80	P0501302	PT20	DT2050	5,0	-	-
A06815 - 100	P0501302	PT20	DT2050	5,0	J0123510	SD6368-12
A06815 - 125	P0501302	PT20	DT2050	5,0	J0164110	SD6368-16
A06815 - 160	P0501302	PT20	DT2050	5,0	-	-

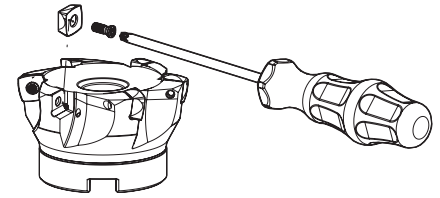

Note: The toolholder is supplied with the XT/PT key. To order the DT key please check the page A-241.
Check the procedures for the clamping screws on the page A-241.

GRADES SELECTION GUIDE | Guia para selecção de graus | Tabla para selección de calidades

ISO	PSM	Material	HB (Brinell)	Grades			
				← Wear Resistance		Toughness →	
				PHP910	PHP920	PHH930	PH7740
P	1	Unalloyed Steel	125-220	●	●		●
	2	Low-Alloyed Steel	220-280	●	●		●
	3	High-Alloyed Steel	280-380	●	●		●
M	4	SS - Ferritic / Martensitic	200-330			●	●
	5	SS - Austenitic	200-330			●	●
	6	SS - Austenitic-ferritic (Duplex)	230-260			●	●
K	7	Malleable Cast Iron	130-230	●	●		●
	8	Grey Cast Iron	180-245	●	●		●
	9	Nodular Cast iron	160-250	●	●		●
S	11	Heat Resistant Super Alloys	200-320			●	●

● Good Conditions
● Average Conditions
● Difficult Conditions

RECOMMENDED CUTTING CONDITIONS | Condições de corte recomendadas | Condiciones de corte recomendables

ISO	PSM	Material	HB (Brinell)	Vc (m/min)				Feed fz (mm/t)	
				← Wear Resistance		Toughness →		SOEW S...	SOET MS...
				PHP910	PHP920	PHH930	PH7740		
P	1	Unalloyed Steel	125-220	180-250	180-250	-	140-200	0,50-2,10	0,50-2,20
	2	Low-Alloyed Steel	220-280	160-240	160-230	-	130-180	0,50-2,10	0,50-2,20
	3	High-Alloyed Steel	280-380	140-230	140-220	-	100-170	0,50-2,00	0,50-1,80
M	4	SS - Ferritic / Martensitic	200-330	-	-	140-210	130-180	-	0,50-1,80
	5	SS - Austenitic	200-330	-	-	120-170	110-160	-	0,50-1,80
	6	SS - Austenitic-ferritic (Duplex)	230-260	-	-	100-150	90-150	-	0,50-1,50
K	7	Malleable Cast Iron	130-230	180-300	160-270	-	140-220	0,50-2,10	0,50-2,00
	8	Grey Cast Iron	180-245	160-250	140-250	-	120-210	0,50-2,10	0,50-2,00
	9	Nodular Cast iron	160-250	150-210	120-210	-	100-190	0,50-2,10	0,50-1,80
S	11	Heat Resistant Super Alloys	200-320	-	-	30-110	30-100	-	0,40-1,30

(Note 1) Cutting conditions $a_e/D_c=70\%$.

(Note 2) It's possible to occur vibrations in certain cases. Please reduce depth of cut and / or reduce cutting conditions in following cases:
- When using long shank;
- When using long tool overhang with arbor type;
- When application has poor clamping rigidity or when using a low rigidity machine.

(Note 3) PH5... and PHS... can be used wet or dry. PH7... use only air.

(Note 4) It's possible to occur vibrations in certain cases. Please reduce depth of cut and / or reduce cutting conditions in following cases:
- When using long shank;
- When using long tool overhang with arbor type;
- When application has poor clamping rigidity or when using a low rigidity machine.

CHIP-BREAKER SELECTION GUIDE | Guia para aplicações do quebra- aparas | Guía para aplicación del rompevirutas

ISO	PSM	Material	HB (Brinell)	Chip-Breaker Application	
				1st choice	Difficult Operations
P	1	Unalloyed Steel	125-220	SOET 16...	SOEW 16...
	2	Low-Alloyed Steel	220-280	SOEW 16...	-
	3	High-Alloyed Steel	280-380	SOEW 16...	-
M	4	SS - Ferritic / Martensitic	200-330	SOET 16...	-
	5	SS - Austenitic	200-330	SOET 16...	-
	6	SS - Austenitic-ferritic (Duplex)	230-260	SOET 16...	-
K	7	Malleable Cast Iron	130-230	SOET 16...	SOEW 16...
	8	Grey Cast Iron	180-245	SOEW 16...	-
	9	Nodular Cast iron	160-250	SOEW 16...	-
S	11	Heat Resistant Super Alloys	200-320	SOET 16...	-

PROGRAMMING DATA | Dados para programação | Datos para la programación

Insert	Programming Data			
	Rp	X	b	ae
SO... 1605..	4,5	2,3	13,5	12,8

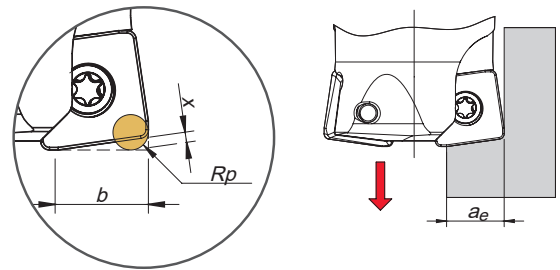

RAMPING AND HELICAL INTERPOLATION

Descida em rampa e interpolação helicoidal | Bajada en rampa e interpolación circular

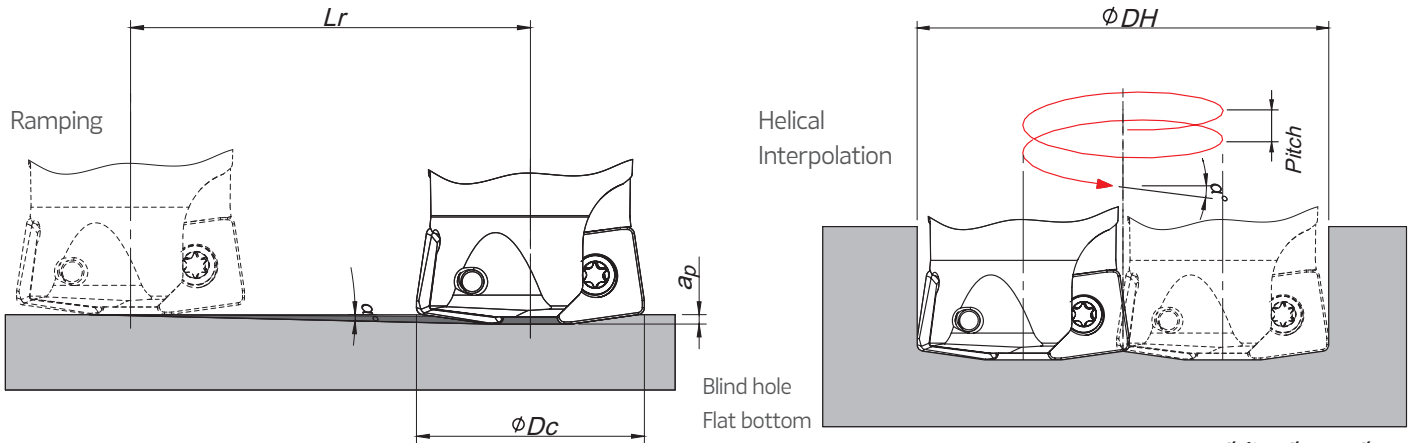

$$\text{Ødi} = \text{ØDH} - \text{ØDc}$$

ØDc	Ramping			Helical Interpolation		
	Max Ramp a°	Max ap	Min Lr	ØDHmin	ØDHmax	Max Pitch/Rev.
63	3,5	3,5	80,2	99,0	-	6
				-	123,6	11
66	3,0	3,5	66,8	105	-	6
				-	129,6	10
80	2,0	3,5	100,2	133	-	5
				-	157,5	8
100	1,5	3,5	133,7	173	-	6
				-	197,5	8
125	1,0	3,5	200,5	223	-	5
				-	247,5	6
160	0,5	3,5	401,1	293	-	3
				-	317,5	4

Note: During helical interpolation do not exceed max Pitch.

PLUNGING | Mergulho | Plunge

$L \leq 3D_c$	$L > 3D_c$	S max.
f_z (mm/t)		
0,10-0,20	0,07-0,14	$S_{max} = \sqrt{D_c \cdot DR - DR^2}$

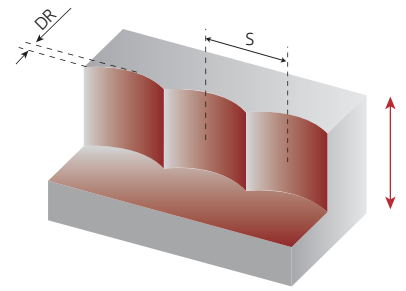

S max and DR corresponding cutting diameter Dc (mm)		
DR (mm)	Dc (mm)	
	66	80
1,0	8,1	8,9
2,0	11,3	12,5
3,0	13,7	15,2
4,0	15,7	17,4
5,0	17,5	19,4
6,0	19,0	21,1
7,0	20,3	22,6
8,0	21,5	24,0
9,0	22,6	25,3
10,0	23,7	26,5
11,0	24,6	27,5
12,0	25,5	28,6

Note: Recommended for $L \leq 4 D_c$ for extra long tool this step and side cut must be reduced.

A

MILLING

Overview

Face milling

Hifeed milling

Shoulder milling

Profile milling

Hardmill

Center & Chamfer

Spot face

Spare Parts

Technical Data

End Mills

HIFEED 50560

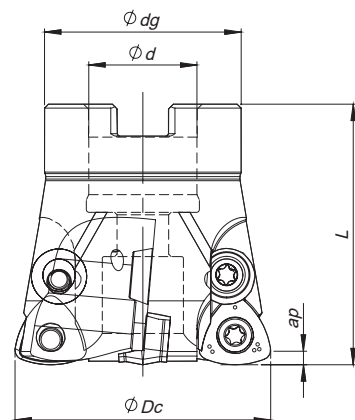

Arbor Mounting

$\gamma_p = +5^\circ$ | $R_p = 3,2$

Order code Código	Reference Referência Referencia		Dimensions Dimensões Dimensiones (mm)				Kg	Specifications		Insert Pastilha Inserto	Stock
			ϕDc	ϕd	ϕdg	L		A_p max (mm)	Arbor Type		
181020800	052C50560-04-05-022053	4	52	22	40	53	0,390	1,5	A	WD... 1204...	
181020200	066C50560-05-05-027053	5	66	27	48	53	0,640	1,5	A	WD... 1204...	
181020300	080C50560-06-05-027053	6	80	27	60	53	1,060	1,5	A	WD... 1204...	
181172400	063C50560-05-05-027053	5	63	27	48	53	0,59	1,5	A	WD... 1204...	

Stock item | Produto de stock | Itens de stock

Available under request (see page A-9) | Disponível sobre consulta (consulte a página A-9) | Disponible bajo consulta (mire pagina A-9)

SPARE PARTS | Complementos | Repuestos

ScrewCutter ϕDc	Insert Screw	Key (Torx)	Order separately		Order separately	
			Key (Torx - Nm)	Torque Value	Washer	Washer Screw
A50560 - 52 - 80						
	P0451001	XT20	DT2050	5,0	HC01200	P0451001

Note: The toolholder is supplied with the XT/PT key. To order the DT key please check the page A-241.
Check the procedures for the clamping screws on the page A-241.

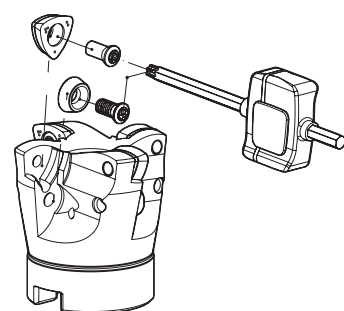



WD... 1204... | Inserts | Pastilhas | Plaquetas

WDET

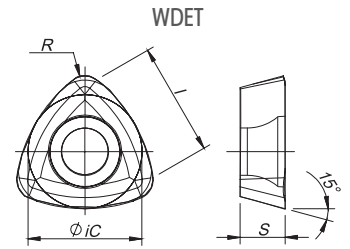

WDMW

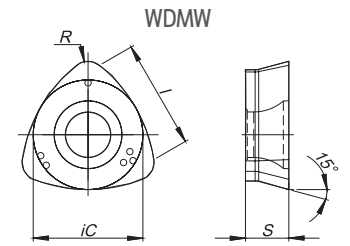

	⁽²⁾ Grade code	P			M		K		S		Dimensions Dimensões Dimensiones (mm)			
		PVD			PVD		PVD		PVD					
		G4	P3	G6	P3	G6	G4	G6	P3	G6				
⁽¹⁾ Geometry code	ISO Reference	PH7920	PH7930	PH7740	PH7930	PH7740	PH7920	PH7740	PH7930	PH7740	iC	S	I	R
1112148	WDET 120420-MS		⊗	⊗	⊗	⊗			⊗	⊗	12,00	4,76	11,9	2,00
1111123	WDMW 120420-T	⊗		⊗			⊗	⊗			12,00	4,76	11,9	2,00

⊗ First choice | Primeira opção | 1ª opción ⊗ Stock item | Produto de stock | Itens de stock ○ Available under request (see page A-9) | Disponível sobre consulta (consulte a página A-9) | Disponible bajo consulta (mire página A-9) Insert order code = (1) Geometry Code + (2) Grade Code

GRADES SELECTION GUIDE | Guia para seleção de graus | Tabla para selección de calidades

ISO	PSM	Material	HB (Brinell)	Grades			
				← Wear Resistance		Toughness →	
				PH7910	PH7920	PH7930	PH7740
P	1	Unalloyed Steel	125-220	●	●	●	●
	2	Low-Alloyed Steel	220-280	✓	✓	✓	✓
	3	High-Alloyed Steel	280-380	✓	✓	✓	✓
M	4	SS - Ferritic / Martensitic	200-330			✓	✓
	5	SS - Austenitic	200-330			✓	✓
	6	SS - Austenitic-ferritic (Duplex)	230-260			✓	✓
K	7	Malleable Cast Iron	130-230	✓	✓	✓	✓
	8	Grey Cast Iron	180-245	✓	✓	✓	✓
	9	Nodular Cast iron	160-250	✓	✓	✓	✓
S	11	Heat Resistant Super Alloys	200-320			✓	✓

● Good Conditions
● Average Conditions
● Difficult Conditions

HIFEED 50560

RECOMMENDED CUTTING CONDITIONS | Condições de corte recomendadas | Condiciones de corte recomendables

ISO	PSM	Material	HB (Brinell)	Vc (m/min)				Feed fz (mm/t)	
				← Wear Resistance		Toughness →		WDMW 12...	WDET 12...
				PH7910	PH7920	PH7930	PH7740		
P	1	Unalloyed Steel	125-220	180-250	180-240	160-220	140-200	0,30-1,50	0,30-1,30
	2	Low-Alloyed Steel	220-280	160-230	160-220	140-200	130-180	0,30-1,50	0,30-1,30
	3	High-Alloyed Steel	280-380	140-220	140-210	120-190	100-170	0,30-1,30	0,30-1,00
M	4	SS - Ferritic / Martensitic	200-330			140-200	130-180	-	0,30-1,30
	5	SS - Austenitic	200-330			120-160	110-160	-	0,30-1,30
	6	SS - Austenitic-ferritic (Duplex)	230-260			100-140	90-150	-	0,30-1,00
K	7	Malleable Cast Iron	130-230	180-300	160-260		140-220	0,30-1,50	-
	8	Grey Cast Iron	180-245	160-250	140-240		120-210	0,30-1,50	-
	9	Nodular Cast iron	160-250	150-200	120-200		100-190	0,30-1,40	-
S	11	Heat Resistant Super Alloys	200-320	-	-	30-100	30-100	-	0,30-1,00

(Note 1) Cutting conditions $a_e/D_c=70\%$.

(Note 2) It's possible to occur vibrations in certain cases. Please reduce depth of cut and / or reduce cutting conditions in following cases:

- When using long shank;
- When using long tool overhang with arbor type;
- When application has poor clamping rigidity or when using a low rigidity machine.

(Note 3) PH5... and PHS... can be used wet or dry. PH7... use only air.

(Note 4) It's possible to occur vibrations in certain cases. Please reduce depth of cut and / or reduce cutting conditions in following cases:

- When using long shank;
- When using long tool overhang with arbor type;
- When application has poor clamping rigidity or when using a low rigidity machine.

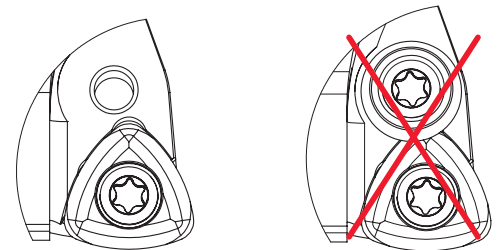

When using WDET insert, please remove the washer and the washer screw, otherwise it will break the insert.

CHIP-BREAKER SELECTION GUIDE | Guia para aplicações do quebra- aparas | Guía para aplicación del rompevirutas

ISO	PSM	Material	HB (Brinell)	Chip-Breaker Application	
				1st choice	Difficult Operations
P	1	Unalloyed Steel	125-220	WDET 12...	WDMW 12...
	2	Low-Alloyed Steel	220-280	WDMW 12...	-
	3	High-Alloyed Steel	280-380	WDMW 12...	-
M	4	SS - Ferritic / Martensitic	200-330	WDET 12...	-
	5	SS - Austenitic	200-330	WDET 12...	-
	6	SS - Austenitic-ferritic (Duplex)	230-260	WDET 12...	-
K	7	Malleable Cast Iron	130-230	WDMW 12...	-
	8	Grey Cast Iron	180-245	WDMW 12...	-
	9	Nodular Cast iron	160-250	WDMW 12...	-
S	11	Heat Resistant Super Alloys	200-320	WDET 12...	-

PROGRAMMING DATA | Dados para programação | Datos para la programación

Insert	Programming Data			
	Rp	x	b	a _e
WD...1204	3,2	0,7	7,2	7,0

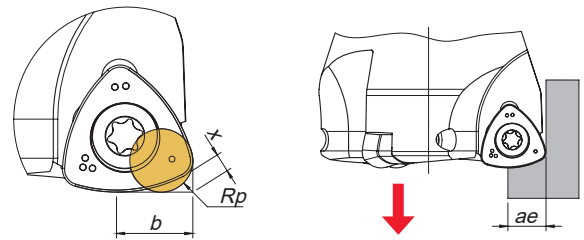

RAMPING AND HELICAL INTERPOLATION

Descida em rampa e interpolação helicoidal | Bajada en rampa e interpolación circular

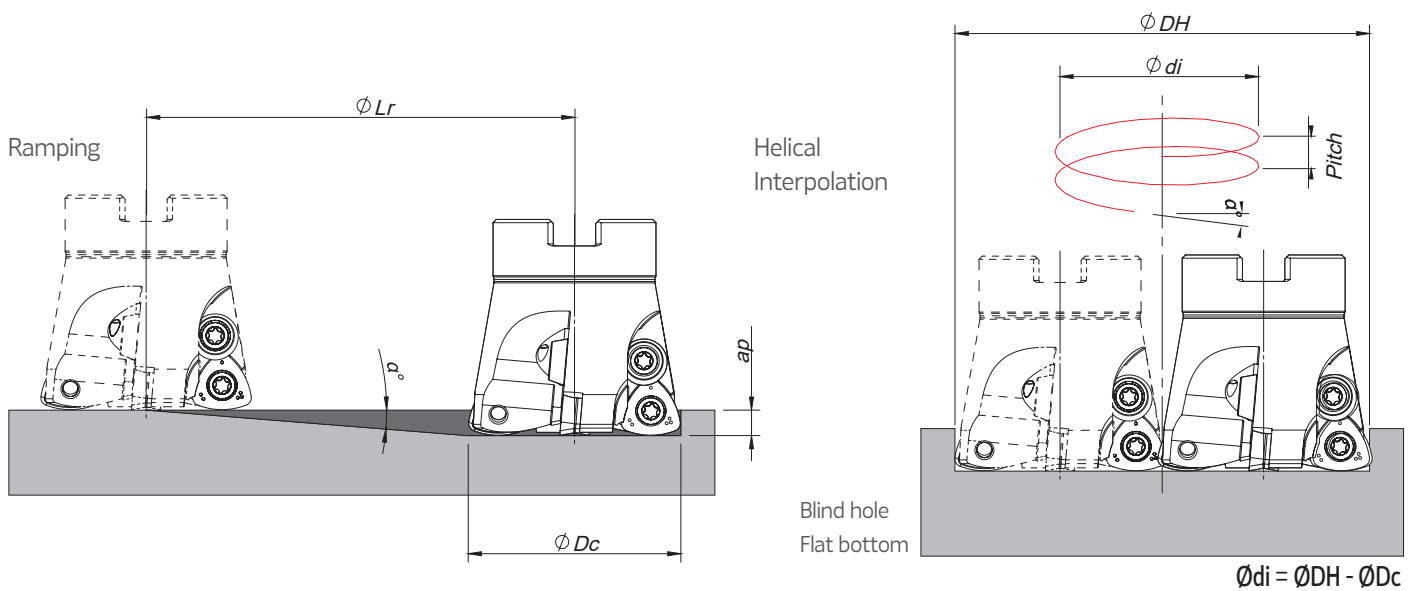

ϕDc	Ramping			Helical Interpolation		
	Max Ramp a°	Max a _p	Min L _r	ϕDH_{min}	ϕDH_{max}	Max Pitch/Rev.
52	0,8	1,5	107,4	89,6	-	1
66	0,4	1,5	214,9	117,6	-	2
				-	102,0	1
80	0,3	1,5	286,5	145,6	-	1
				-	130,0	1
					158,0	1

Note: During helical interpolation do not exceed max Pitch.

HIFEED 50060

A

MILLING

Overview

Face milling

Hifeed milling

Shoulder milling

Profile milling

Hardmill

Center & Chamfer

Spot face

Spare Parts

Technical Data

End Mills

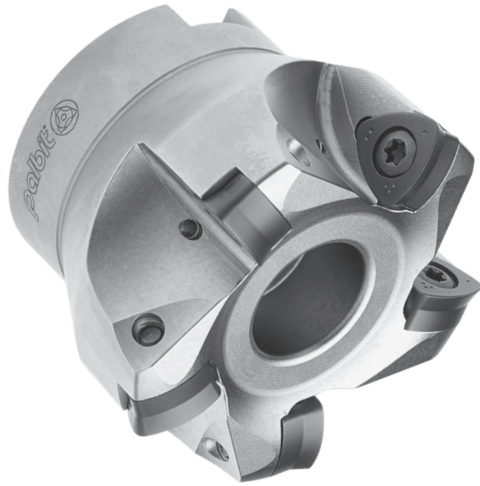

Arbor Mounting

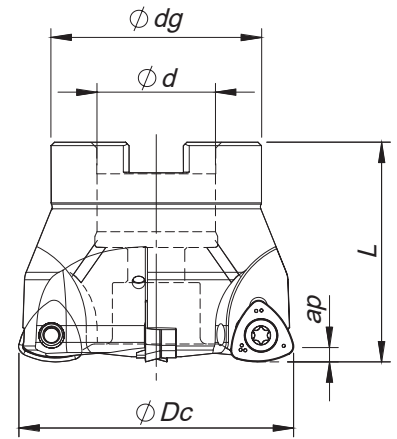
 $\gamma_p=0^\circ$ | $R_p=3,5$

Order code Código	Reference Referência Referencia		Dimensions Dimensões Dimensiones (mm)				Kg	Specifications		Insert Pastilha Inserto	Stock
			ϕDc	ϕd	ϕdg	L		A_p max (mm)	Arbor Type		
181020400	052A50060-03-022045	3	52	22	40	45	0,320	1,8	A	WN... 1207	
181033900	063A50060-04-027050	4	63	27	48	50	0,547	1,8	A	WN... 1207	
181028700	066A50060-04-027050	4	66	27	48	50	0,597	1,8	A	WN... 1207	
181035900	066A50060-05-027050	5	66	27	48	50	0,610	1,8	A	WN... 1207	
181020100	080A50060-05-027050	5	80	27	60	50	1,000	1,8	A	WN... 1207	

Stock item | Produto de stock | Itens de stock

Available under request (see page A-9) | Disponível sobre consulta (consulte a página A-9) | Disponible bajo consulta (mire pagina A-9)

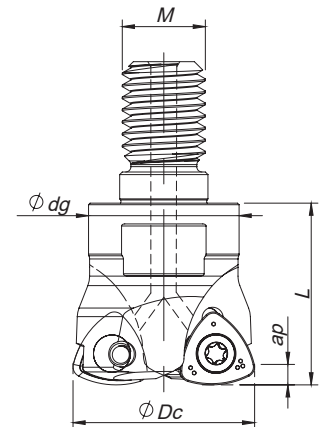

Threaded Coupling

 $\gamma_p=0^\circ$ | $R_p=3,5$

Order code Código	Reference Referência Referencia		Dimensions Dimensões Dimensiones (mm)				Kg	Specifications		Insert Pastilha Inserto	Stock
			ϕDc	ϕM	ϕdg	L		A_p max (mm)			
181039000	035R50060-02-M16035	2	35	M16	29	35	0,166	1,8	WN... 1207		

Stock item | Produto de stock | Itens de stock

Available under request (see page A-9) | Disponível sobre consulta (consulte a página A-9) | Disponible bajo consulta (mire pagina A-9)

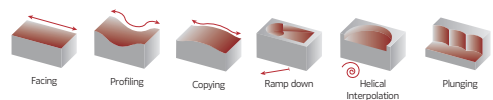

WNMW 1207 | Inserts | Pastilhas | Plaquetas

WNMW

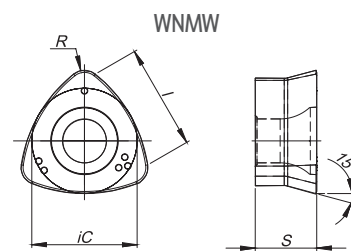
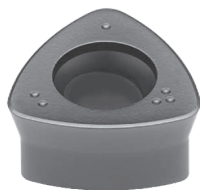

	⁽²⁾ Grade code	P				K		Dimensions Dimensões Dimensiones (mm)			
		PVD				CVD					
⁽¹⁾ Geometry code	ISO Reference	G1	G4	78	86	G1	G4	iC	S	I	R
1121148	WNMW 1207-SP							12,00	7,00	11,90	2,00

First choice | Primeira opção | 1ª opción Stock item | Produto de stock | Itens de stock Available under request (see page A-9) | Disponível sobre consulta (consulte a página A-9) | Disponible bajo consulta (mire página A-9) Insert order code = (1) Geometry Code + (2) Grade Code

SPARE PARTS | Complementos | Repuestos

Cutter ØDc	Insert Screw	Key (Torx)	Order separately	
			Key (Torx - Nm)	Torque Value
R50060 – 35	P0451400	XT20	DT2050	5,0
A50060 – 52 - 80	P0451400	XT20	DT2050	5,0

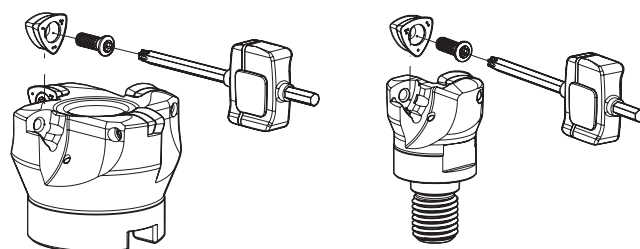

Note: The toolholder is supplied with the XT/PT key. To order the DT key please check the page A-241. Check the procedures for the clamping screws on the page A-241.

GRADES SELECTION GUIDE | Guia para selecção de graus | Tabla para selección de calidades

ISO	PSM	Material	HB (Brinell)	Grades			
				← Wear Resistance		Toughness →	
				PH7910	PH7920	PH6125	PH6135
P	1	Unalloyed Steel	125-220				
	2	Low-Alloyed Steel	220-280				
	3	High-Alloyed Steel	280-380				
K	7	Malleable Cast Iron	130-230				
	8	Grey Cast Iron	180-245				
	9	Nodular Cast iron	160-250				

Good Conditions
 Average Conditions
 Difficult Conditions

HIFEED 50060

RECOMMENDED CUTTING CONDITIONS | Condições de corte recomendadas | Condiciones de corte recomendables

ISO	PSM	Material	HB (Brinell)	Vc (m/min)				Feed fz (mm/t)
				← Wear Resistance			Toughness →	
				PH7910	PH7920	PH6125	PH6135	
P	1	Unalloyed Steel	125-220	180-250	180-240	160-190	150-180	0,30-1,50
	2	Low-Alloyed Steel	220-280	160-230	160-220	140-180	140-170	0,30-1,50
	3	High-Alloyed Steel	280-380	140-220	140-210	130-160	120-150	0,30-1,30
K	7	Malleable Cast Iron	130-230	180-300	160-260	-	-	0,30-1,50
	8	Grey Cast Iron	180-245	160-250	140-240	-	-	0,30-1,50
	9	Nodular Cast iron	160-250	150-200	120-200	-	-	0,30-1,40

(Note 1) Cutting conditions $a_e/D_c=70\%$.

(Note 2) It's possible to occur vibrations in certain cases. Please reduce depth of cut and / or reduce cutting conditions in following cases:

- When using long shank;
- When using long tool overhang with arbor type;
- When application has poor clamping rigidity or when using a low rigidity machine.

(Note 3) PH5... and PHS... can be used wet or dry. PH7... use only air.

(Note 4) It's possible to occur vibrations in certain cases. Please reduce depth of cut and / or reduce cutting conditions in following cases:

- When using long shank;
- When using long tool overhang with arbor type;
- When application has poor clamping rigidity or when using a low rigidity machine.

PROGRAMMING DATA | Dados para programação | Datos para la programación

Insert	Programming Data			
	Rp	X	b	a _e
WNMW 12	3,5	0,9	8,4	8,0

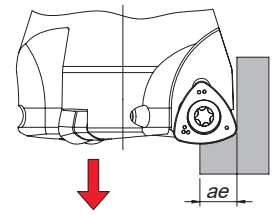
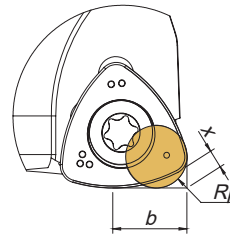

RAMPING AND HELICAL INTERPOLATION

Descida em rampa e interpolação helicoidal | Bajada en rampa e interpolación circular

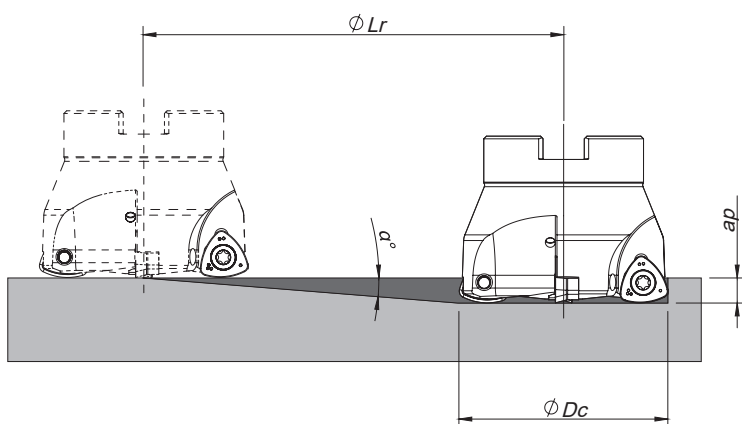

Helical Interpolation

Blind hole
Flat bottom

$$\phi di = \phi DH - \phi Dc$$

ϕDc	Ramping			Helical Interpolation		
	Max Ramp a°	Max ap	Min Lr	ϕDH_{min}	ϕDH_{max}	Max Pitch/Rev.
35	3,0	1,8	34,3	53,2 -	- 68,0	2 5
52	1,8	1,8	57,3	87,2 -	- 102,0	3 4
63	1,2	1,8	85,9	109,2 -	- 124,0	3 4
66	1,0	1,8	114,6	115,2 -	- 130,0	3 3
80	0,9	1,8	114,6	143,0 -	- 158,0	3 3

Note: During helical interpolation do not exceed max Pitch.

PLUNGING | Mergulho | Plunge

$L \leq 3Dc$	$L > 3Dc$	S_{max}
f_z (mm/t)		
0,10-0,20	0,07-0,14	$S_{max} = \sqrt{Dc \cdot DR - DR^2}$

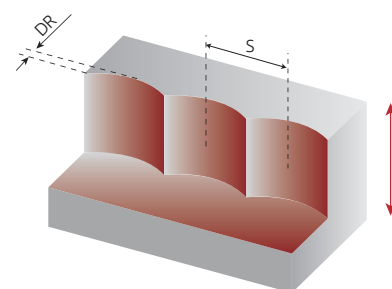

S max and DR corresponding cutting diameter Dc (mm)					
DR (mm)	Dc (mm)				
	35	52	63	66	80
1,0	5,8	7,1	7,9	8,1	8,9
2,0	8,1	10,0	11,0	11,3	12,5
3,0	9,8	12,1	13,4	13,7	15,2
4,0	11,1	13,9	15,4	15,7	17,4
5,0	12,2	15,3	17,0	17,5	19,4
6,0	13,2	16,6	18,5	19,0	21,1
7,0	14,0	17,7	19,8	20,3	22,6
8,0	14,7	18,8	21,0	21,5	24,0

Note: Recommended for $L \leq 4 Dc$, for $L > 4 Dc$ steps must be reduced to 40%.

HIFEED 06590

A

MILLING

Overview

Face milling

Hifeed milling

Shoulder milling

Profile milling

Hardmill

Center & Chamfer

Spot face

Spare Parts

Technical Data

End Mills

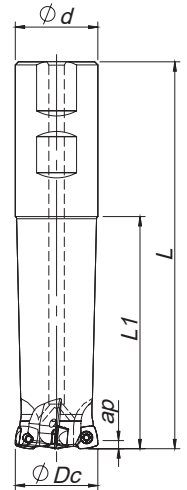

Weldon Shank

 $\gamma_p = +5^\circ$ | $R_p = 1,8$

Order code Código	Reference Referência Referencia		Dimensions Dimensões Dimensiones (mm)				Kg	Specifications	Insert Pastilha Inserto	Stock
			ϕDc	ϕd	L	L1		Ap max (mm)		
181047600	020W06590-02-05-020130	2	20	20	130	75	0,250	1,2	SP... 08T3...	
181047900	020W06590-02-05-020190	2	20	20	190	110	0,380	1,2	SP... 08T3...	
181047700	025W06590-03-05-025140	3	25	25	140	80	0,431	1,2	SP... 08T3...	
181048000	025W06590-03-05-025200	3	25	25	200	130	0,611	1,2	SP... 08T3...	
181047800	032W06590-04-05-032150	4	32	32	150	90	0,780	1,2	SP... 08T3...	
181048100	032W06590-04-05-032200	4	32	32	200	130	1,040	1,2	SP... 08T3...	

Stock item | Produto de stock | Itens de stock

Available under request (see page A-9) | Disponível sobre consulta (consulte a página A-9) | Disponible bajo consulta (mire pagina A-9)

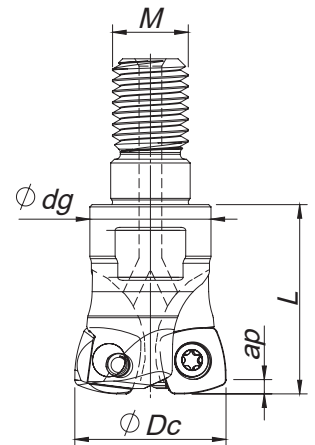

Threaded Coupling

 $\gamma = +5^\circ$ | $R_p = 1,8$

Order code Código	Reference Referência Referencia		Dimensions Dimensões Dimensiones (mm)				Kg	Specifications	Insert Pastilha Inserto	Stock
			ϕDc	ϕM	ϕdg	L		Ap max (mm)		
181031100	020R06590-02-05-M10025	2	20	M10	16	25	0,040	1,2	SP... 08T3...	
181029400	025R06590-03-05-M12028	3	25	M12	21	28	0,071	1,2	SP... 08T3...	
181029600	032R06590-04-05-M16035	4	32	M16	29	35	0,162	1,2	SP... 08T3...	
181045800	035R06590-04-05-M16035	4	35	M16	29	35	0,176	1,2	SP... 08T3...	
181031000	042R06590-05-05-M16035	5	42	M16	29	35	0,215	1,2	SP... 08T3...	

Stock item | Produto de stock | Itens de stock

Available under request (see page A-9) | Disponível sobre consulta (consulte a página A-9) | Disponible bajo consulta (mire pagina A-9)

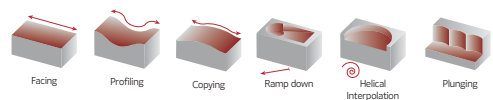

SP..08T3.. || Inserts | Pastilhas | Plaquetas

SPKW

SPKT

SPKW | SPKT

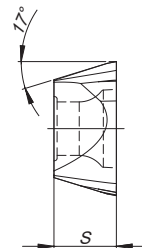
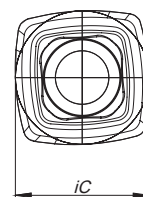

		P	M	K	Dimensions Dimensões Dimensiones (mm)	
		PVD	PVD	PVD	iC	S
(2) Grade code		68	68	68		
(1) Geometry code	ISO Reference	PH6920	PH6920	PH6920		
1111364	SPKW 08T308-E	⊗		⊗	8,50	3,97
1121227	SPKW 08T308-S	⊗		⊗	8,50	3,97
1111314	SPKT 08T308-E	⊗	⊗	⊗	8,50	3,97

⊗ First choice | Primeira opção | 1ª opción

⊗ Stock item | Produto de stock | Itens de stock

○ Available under request (see page A-9) | Disponível sobre consulta (consulte a página A-9) | Disponible bajo consulta (mire página A-9)

Insert order code = (1) Geometry Code + (2) Grade Code

SPARE PARTS || Complementos | Repuestos

Cutter ØDc	Insert Screw	Key (Torx)	Order separately	
			Key (Torx - Nm)	Torque Value
W06590 - 20 - 32	P0300800	XT09	DT0914	1,4
R06590 - 20 - 42	P0300800	XT09	DT0914	1,4

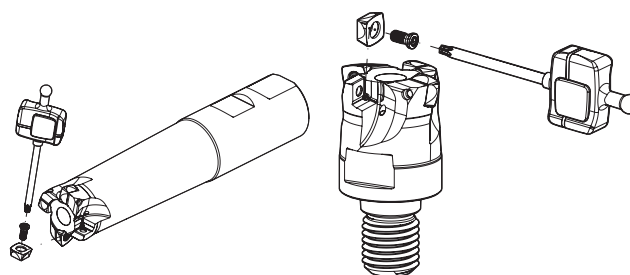

Note: The toolholder is supplied with the XT/PT key. To order the DT key please check the page A-241. Check the procedures for the clamping screws on the page A-241.

HIFEED 06590

RECOMMENDED CUTTING CONDITIONS | Condições de corte recomendadas | Condiciones de corte recomendables

ISO	PSM	Material	HB (Brinell)	Vc (m/min)		Feed fz (mm/t)	
				PH6920	SP ... 08T308		
P	1	Unalloyed Steel	125-220	150-230		0,30-1,50	
	2	Low-Alloyed Steel	220-280	140-220		0,30-1,50	
	3	High-Alloyed Steel	280-380	130-180		0,30-1,30	
M	4	SS - Ferritic / Martensitic	200-330	120-160		0,30-1,40	
	5	SS - Austenitic	200-330	100-150		0,30-1,40	
	6	SS - Austenitic-ferritic (Duplex)	230-260	70-110		0,30-1,20	
K	7	Malleable Cast Iron	130-230	150-280		0,30-1,50	
	8	Grey Cast Iron	180-245	130-230		0,30-1,50	
	9	Nodular Cast iron	160-250	80-190		0,30-1,40	

(Note 1) Cutting conditions $a_e/D_c=70\%$.

(Note 2) It's possible to occur vibrations in certain cases. Please reduce depth of cut and / or reduce cutting conditions in following cases:

- When using long shank;
- When using long tool overhang with arbor type;
- When application has poor clamping rigidity or when using a low rigidity machine.

(Note 3) Use only air.

(Note 4) It's possible to occur vibrations in certain cases. Please reduce depth of cut and / or reduce cutting conditions in following cases:

- When using long shank;
- When using long tool overhang with arbor type;
- When application has poor clamping rigidity or when using a low rigidity machine.

CHIP-BREAKER SELECTION GUIDE | Guia para aplicações do quebra-apanas | Guía para aplicación del rompevirutas

ISO	PSM	Material	HB (Brinell)	Chip-Breaker Application	
				1st choice	Difficult Operations
P	1	Unalloyed Steel	125-220	SPKT 08...	SPKW 08...
	2	Low-Alloyed Steel	220-280	SPKW 08...	-
	3	High-Alloyed Steel	280-380	SPKW 08...	-
M	4	SS - Ferritic / Martensitic	200-330	SPKT 08...	-
	5	SS - Austenitic	200-330	SPKT 08...	-
	6	SS - Austenitic-ferritic (Duplex)	230-260	SPKW 08...	SPKW 08...
K	7	Malleable Cast Iron	130-230	SPKT 08...	SPKW 08...
	8	Grey Cast Iron	180-245	SPKW 08...	-
	9	Nodular Cast iron	160-250	SPKW 08...	-

PROGRAMMING DATA | Dados para programação | Datos para la programación

Insert	Programming Data			
	Rp	X	b	a_e
SP... 08T3...	1,9	0,7	5,6	6,6

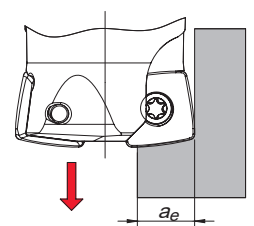
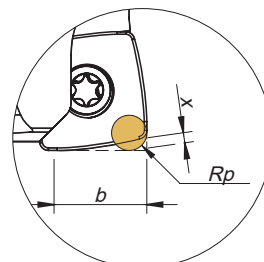

RAMPING AND HELICAL INTERPOLATION

Descida em rampa e interpolação helicoidal | Bajada en rampa e interpolación circular

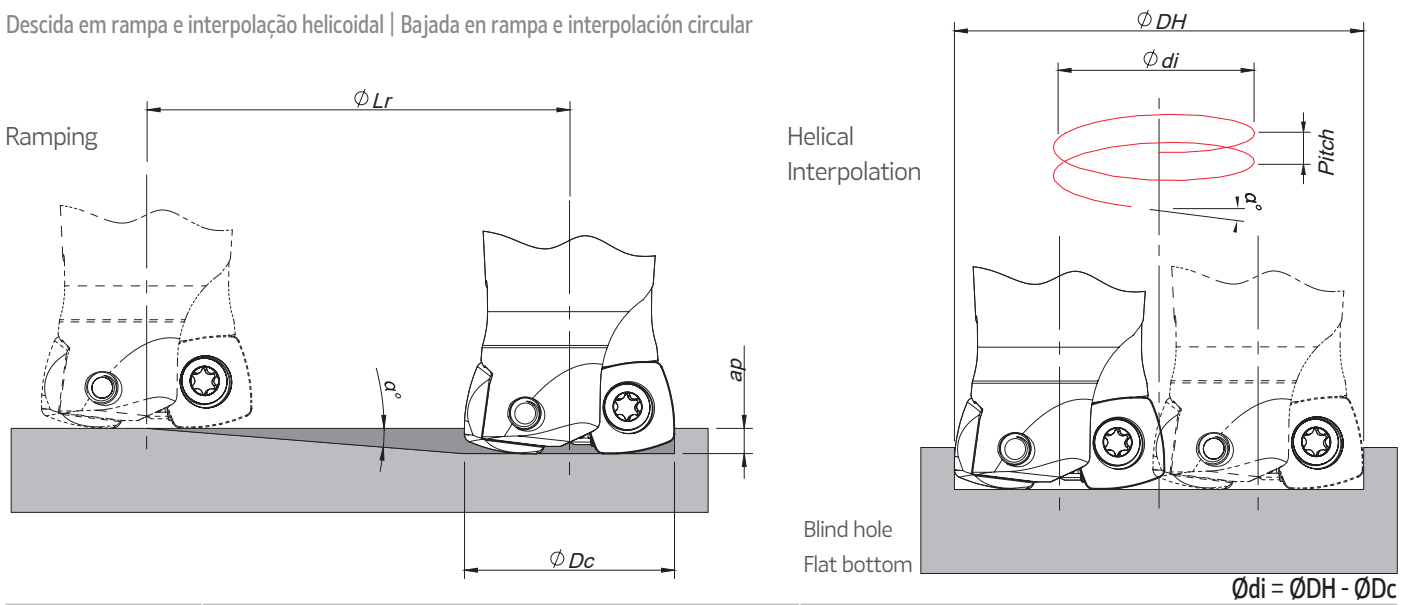

ϕDc	Ramping			Helical Interpolation		
	Max Ramp a°	Max ap	Min Lr	ϕDH_{min}	ϕDH_{max}	Max Pitch/Rev.
20	0,5	1,2	137,5	27,8	-	0,2
25	1	1,2	68,7	37,8	38,0	0,5
32	1,4	1,2	49,1	51,8	48,0	0,7
35	1,1	1,2	62,5	57,8	62,0	1,2
42	0,9	1,2	76,4	71,8	68,0	1,5
					82,0	2,3
						1,3
						2,0
						1,4
						1,9

Note: During helical interpolation do not exceed max Pitch.

PLUNGING | Mergulho | Plunge

$L \leq 3Dc$	$L > 3Dc$	S_{max}
f_z (mm/t)		
0,08-0,15	0,05-0,10	$S_{max} = \sqrt{DC \cdot Dr - Dr^2}$

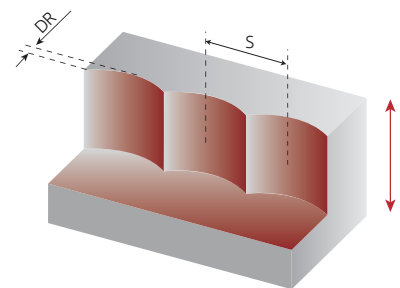

S max and DR corresponding cutting diameter Dc (mm)					
DR (mm)	Dc (mm)				
	20	25	32	35	42
1,0	4,4	4,9	5,6	5,8	6,4
2,0	6,0	6,8	7,7	8,1	8,9
3,0	7,1	8,1	9,3	9,8	10,8
4,0	8,0	9,2	10,6	11,1	12,3
5,0	8,7	10,0	11,6	12,2	13,6
6,0	9,2	10,7	12,5	13,2	14,7

Note: Recommended for $L \leq 4 Dc$ for extra long tool this step and side cut must be reduced.

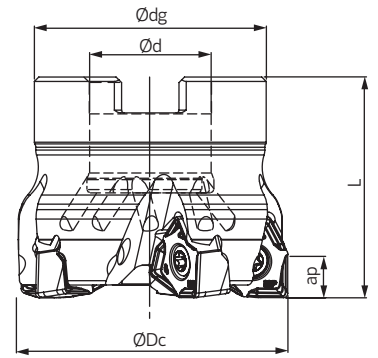

Arbor Mounting

$$K_r = 90^\circ \quad | \quad \gamma_p = -6^\circ$$

(1) Geometry code	Reference Referência Referencia		Dimensions Dimensões Dimensiones (mm)				Kg	Specifications		Insert Pastilha Inserto	Stock
			ØDc	Ød	Ødg	L		Arbor Type	Ap max (mm)		
181174900	040A49590-03-06-016040		40	16	32	40	0,15	A	7,5	WNXT 0806...	
181175000	040A49590-04-06-016040		40	16	32	40	0,13	A	7,5	WNXT 0806...	
181173400	050A49590-04-06-022040		50	22	42	40	0,39	A	7,5	WNXT 0806...	
181165600	050A49590-05-06-022040		50	22	42	40	0,38	A	7,5	WNXT 0806...	
181173500	063A49590-05-06-022040		63	22	52	40	0,5	A	7,5	WNXT 0806...	
181173600	063A49590-06-06-022040		63	22	52	40	0,49	A	7,5	WNXT 0806...	
181173700	080A49590-07-06-027050		80	27	60	50	1,18	B	7,5	WNXT 0806...	
181173800	080A49590-09-06-027050		80	27	60	50	1,16	B	7,5	WNXT 0806...	
181173900	100A49590-08-06-032050		100	32	80	50	1,62	B	7,5	WNXT 0806...	
181174000	100A49590-11-06-032050		100	32	80	50	1,55	B	7,5	WNXT 0806...	
181174100	125A49590-11-06-040063		125	40	90	63	2,82	B	7,5	WNXT 0806...	
181174200	125A49590-14-06-040063		125	40	90	63	2,76	B	7,5	WNXT 0806...	

Stock item | Produto de stock | Itens de stock

Available under request | Disponível sobre consulta
Disponível bajo consulta

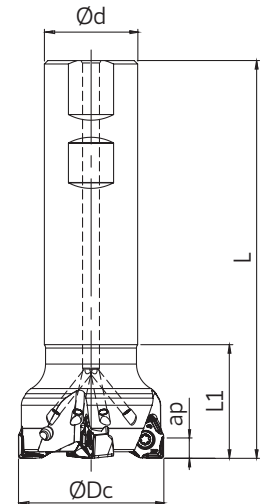

Weldon Shank

$$K_r = 90^\circ \quad | \quad \gamma_p = -6^\circ$$

(1) Geometry code	Reference Referência Referencia		Dimensions Dimensões Dimensiones (mm)				Kg	Specifications		Insert Pastilha Inserto	Stock
			ØDc	Ød	L	L1		ap max (mm)			
181174300	032W49590-02-06-032125		32	32	125	40	0,65	7,5	WNXT 0806...		
181174400	032W49590-03-06-032125		32	32	125	40	0,60	7,5	WNXT 0806...		
181174500	040W49590-03-06-032130		40	32	130	40	0,70	7,5	WNXT 0806...		
181174600	040W49590-04-06-032130		40	32	130	40	0,65	7,5	WNXT 0806...		
181174700	050W49590-04-06-032140		50	32	140	45	0,86	7,5	WNXT 0806...		
181174800	050W49590-05-06-032140		50	32	140	45	0,81	7,5	WNXT 0806...		

Stock item | Produto de stock | Itens de stock

Available under request | Disponível sobre consulta
Disponível bajo consulta

WNXT | Inserts | Pastilhas | Plaquitas

WNXT NEW

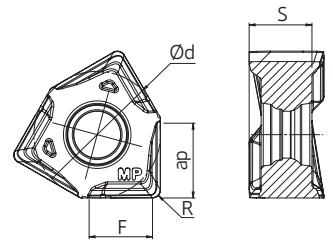

(1) Geometry code	(2) Grade code Reference Referência Referencia	P		K		Dimensions Dimensões Dimensiones (mm)		
		PVD		PVD				
		T1	P4	T1	P4	iC	S	R
1113000	WNXT 080608 PNSR-MP	PHP920	PHP930	PHP920	PHP930	12,7	6,3	0,8

🔴 First choice | Primeira opção | 1ª opção
📦 Stock item | Produto de stock | Itens de stock
🕒 Available under request | Disponível sobre consulta | Disponible bajo consulta
📄 Insert order code = (1) Geometry Code + (2) Grade Code

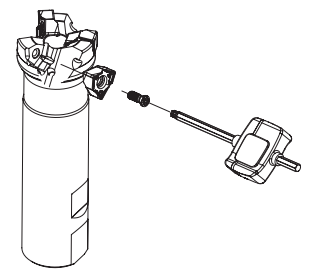
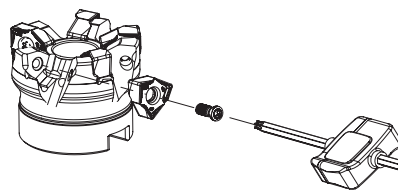

SPARE PARTS Complementos | Repuestos

Cutter ØDc	Insert Screw	Key (Torx)	Key (Torx - Nm)	Torque Value	Screw	DIN 6368 Wrench	Retaining Screw
W49590 - 25 - 50	P0401200	XT15	DT1530	3,0	-	-	-
A49590 - 40	P0401200	XT15	DT1530	3,0	-	-	-
A49590 - 50 - 63	P0401200	XT15	DT1530	3,0	-	-	290087600
A49590 - 80	P0401200	XT15	DT1530	3,0	J0123510	SD6368-12	-
A49590 - 100	P0401200	PT15	DT1530	3,0	J0164110	SD6368-16	-
A49590 - 125	P0401200	PT15	DT1530	3,0	J0204610	SD6368-20	-



GRADES SELECTION GUIDE | Guia para selecção de graus | Tabla para selección de calidades

ISO	PSM	Material	HB (Brinell)	Grades	
				← Wear Resistance	Toughness →
				PHP920	PHP930
P	1	Unalloyed Steel	125-220	✓	✓
	2	Low-Alloyed Steel	220-280	✓	✓
	3	High-Alloyed Steel	280-380	✓	✓
K	7	Malleable Cast Iron	130-230	✓	✓
	8	Grey Cast Iron	180-245	✓	✓
	9	Nodular Cast iron	160-250	✓	✓

-  Good Conditions
-  Average Conditions
-  Difficult Conditions

RECOMMENDED CUTTING CONDITIONS | Condições de corte recomendadas | Condiciones de corte recomendables

ISO	PSM	Material	HB (Brinell)	Vc (m/min)		Feed fz (mm/t)
				← Wear Resistance	Toughness →	
				PHP920	PHP930	
P	1	Unalloyed Steel	125-220	180-250	160-230	0,08 - 0,25
	2	Low-Alloyed Steel	220-280	160-230	140-210	0,08 - 0,25
	3	High-Alloyed Steel	280-380	140-220	120-200	0,08 - 0,20
K	7	Malleable Cast Iron	130-230	130-230	150-250	0,08 - 0,25
	8	Grey Cast Iron	180-245	180-245	140-230	0,08 - 0,25
	9	Nodular Cast iron	160-250	120-210	100-200	0,08 - 0,20

RAMPING AND HELICAL INTERPOLATION

Descida em rampa e interpolação helicoidal | Bajada en rampa e interpolación circular

Ramping

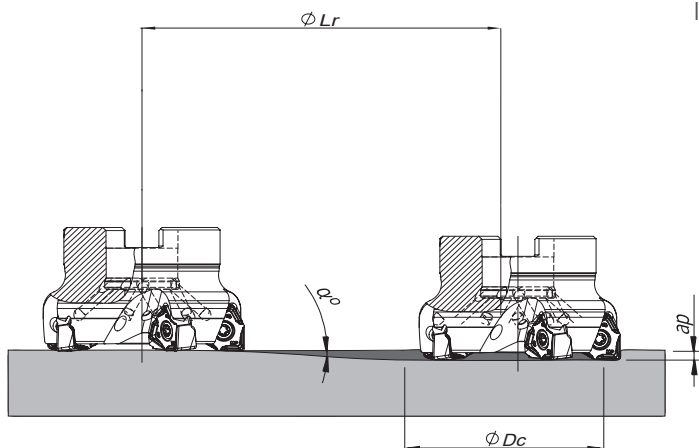

Helical Interpolation

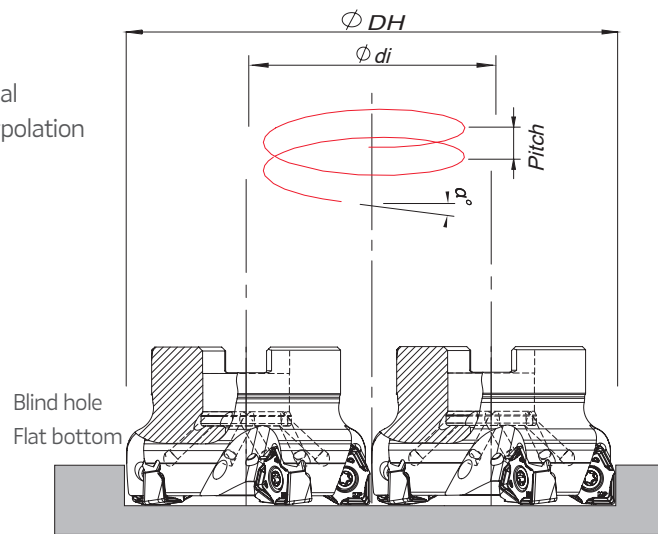

$$\phi di = \phi DH - \phi Dc$$

ØDc	Ramping			Helical Interpolation		
	Max Ramp α°	Max ap	Min Lr	ØDHmin	ØDHmax	Max Pitch/Rev.
32	4,0	7,5	107,3	52 -	- 62	4,3 6,6
40	3,8	7,5	112,9	68 -	- 78	5,8 8
50	3,5	7,5	122,6	88 -	- 98	7,3 9,2
63	3,5	7,5	122,6	114 -	- 124	9 11,7
80	3,0	7,5	143,1	148 -	- 158	11,1 12,9
100	2,1	7,5	204,5	188 -	- 198	10,1 11,3
125	1,4	7,5	306,9	238 -	- 248	8,6 9,4

Note: During helical interpolation do not exceed max Pitch.

(*) Down cutting is recommended, tool pass rotation should be counter-clockwise.

(*) In case of ramping and helical interpolation, apply 70% or less feed (fz) from recommended cutting conditions table.

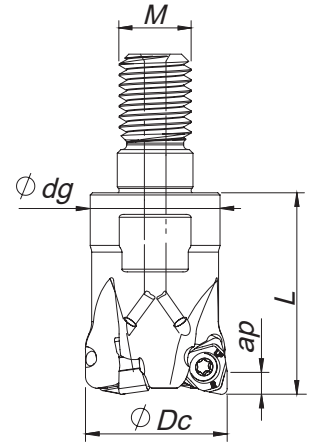

Threaded Coupling

$\kappa_r = 90^\circ$ | $\gamma_p = -7^\circ$

Order code Código	Reference Referência Referencia		Dimensions Dimensões Dimensiones (mm)				Kg	Specification	Insert Pastilha Inserto	Stock
			ØDc	M	Ødg	L		Ap max (mm)		
181136000	016R49090-02-07-M08023	2	16	M08	13	23	0,023	3,00	WNHU 04T308-LP	
181128300	020R49090-03-07-M10028	3	20	M10	18	28	0,052	3,00	WNHU 04T308-LP	
181110900	025R49090-04-07-M12030	4	25	M12	21	30	0,078	3,00	WNHU 04T308-LP	
181128400	032R49090-05-07-M16035	5	32	M16	29	35	0,150	3,00	WNHU 04T308-LP	

Stock item | Produto de stock | Itens de stock

Available under request (see page A-9) | Disponível sobre consulta (consulte a página A-9) | Disponible bajo consulta (mire pagina A-9)

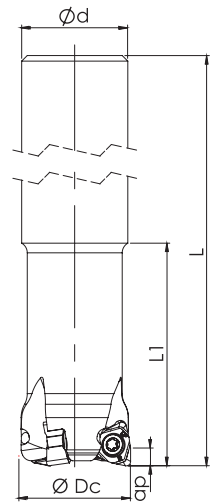

Cylindrical Shank

$\kappa_r = 90^\circ$ | $\gamma_p = -7^\circ$

Order code Código	Reference Referência Referencia		Dimensions Dimensões Dimensiones (mm)				Kg	Specification	Insert Pastilha Inserto	Stock
			ØDc	Ød	L	L1		Ap max (mm)		
181136100	016E49090-02-07-U015150	2	16	15	150	32	0,185	3,00	WNHU 04T308-LP	
181136200	020E49090-03-07-U019150	3	20	19	150	40	0,292	3,00	WNHU 04T308-LP	
181136300	025E49090-04-07-U024150	4	25	24	150	50	0,471	3,00	WNHU 04T308-LP	

Stock item | Produto de stock | Itens de stock

Available under request (see page A-9) | Disponível sobre consulta (consulte a página A-9) | Disponible bajo consulta (mire pagina A-9)

SPARE PARTS || Complementos | Repuestos

Cutter ØDc	Order separately			
	Insert Screw	Key (Torx)	Key (Torx - Nm)	Torque Value
R49090 - 20-32	P0250704	XT08	DT0812	1,2
E49090 - 16-25	P0250704	XT08	DT0812	1,2

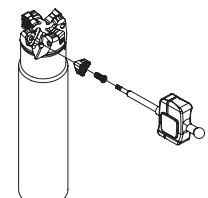
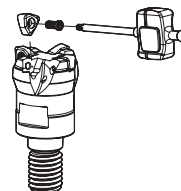

Note: The toolholder is supplied with the XT/PT key. To order the DT key please check the page A-241.
Check the procedures for the clamping screws on the page A-241.

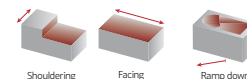

WNHU 04T308 | Inserts | Pastilhas | Plaquetas

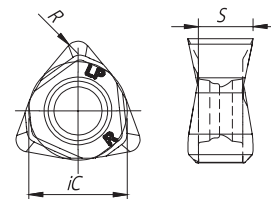
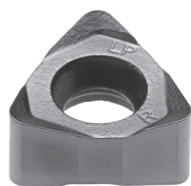

(1) Geometry code	(2) Grade code	P			K			Dimensions Dimensões Dimensiones (mm)		
		PVD			PVD			iC	S	R
		X5	T1	P4	X5	T1	P4			
1112277	WNHU 04T308 PNER-LP	PHP910	PHP920	PHP930	PHP910	PHP920	PHP930	6,35	3,50	0,80

⊗ First choice | Primeira opção | 1ª opción
⊗ Stock item | Produto de stock | Itens de stock
○ Available under request (see page A-9) | Disponível sobre consulta (consulte a página A-9) | Disponible bajo consulta (mire página A-9)
Insert order code = (1) Geometry Code + (2) Grade Code

GRADES SELECTION GUIDE | Guia para selecção de graus | Tabla para selección de calidades

ISO	PSM	Material	HB (Brinell)	Grades		
				← Wear Resistance		Toughness →
				PHP910	PHP920	PHP930
P	1	Unalloyed Steel	125-220	●	●	●
	2	Low-Alloyed Steel	220-280	●	●	●
	3	High-Alloyed Steel	280-380	●	●	●
K	7	Malleable Cast Iron	130-230	●	●	●
	8	Grey Cast Iron	180-245	●	●	●
	9	Nodular Cast iron	160-250	●	●	●

- Good Conditions
- Average Conditions
- Difficult Conditions

RECOMMENDED CUTTING CONDITIONS | Condições de corte recomendadas | Condiciones de corte recomendables

ISO	PSM	Material	HB (Brinell)	Vc (m/min)			Feed fz (mm/t)
				← Wear Resistance		Toughness →	
				PHP910	PHP920	PHP930	WNHU 04T3
P	1	Unalloyed Steel	125-220	180-250	180-250	160-230	0,10-0,30
	2	Low-Alloyed Steel	220-280	160-240	160-230	140-210	0,10-0,30
	3	High-Alloyed Steel	280-380	140-230	140-220	120-200	0,10-0,25
K	7	Malleable Cast Iron	130-230	180-300	160-270	150-250	0,10-0,30
	8	Grey Cast Iron	180-245	160-250	140-250	140-230	0,10-0,30
	9	Nodular Cast iron	160-250	150-210	120-210	100-200	0,10-0,25

Insert	Feed fz (mm/t)		ap Rec.
	Roughing	Finishing	
WNHU 04T308-LP	0.15-0.30	0.10-0.25	0.50-3.00

(Note 1) Cutting conditions should be adjusted according to the machine and work rigidity.
(Note 2) If chattering occurs, reduce ap and Vc by 30% and keep the same fz per tooth.

A

MILLING

Overview

Face milling

Hi-feed milling

Shoulder milling

Profile milling

Hardmill

Center & Chamfer

Spotface

Spare Parts

Technical Data

End Mills

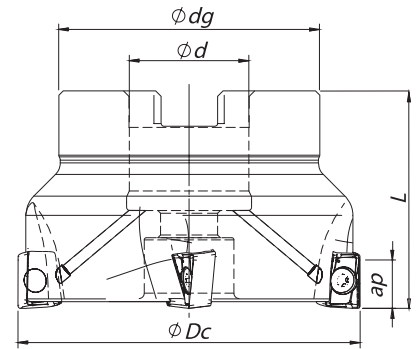

Arbor Mounting

$K_r = 90^\circ$ | $\gamma_p = -7^\circ$

Order code Código	Reference Referência Referencia		Dimensions Dimensões Dimensiones (mm)				Kg	Specifications		Insert Pastilha Inserto	Stock
			ϕDc	ϕd	ϕdg	L		Arbor Type	Ap max (mm)		
181075300	040A17190-04-07-016040	4	40	16	32	40	0,21	A	9,00	ANHX 1004...	
181075400	040A17190-05-07-016040	5	40	16	32	40	0,21	A	9,00	ANHX 1004...	
181075500	050A17190-05-07-022040	5	50	22	42	40	0,35	A	9,00	ANHX 1004...	
181075600	050A17190-07-07-022040	7	50	22	42	40	0,34	A	9,00	ANHX 1004...	
181075700	063A17190-07-07-022040	7	63	22	52	40	0,55	A	9,00	ANHX 1004...	
181075800	063A17190-09-07-022040	9	63	22	52	40	0,54	A	9,00	ANHX 1004...	
181075900	080A17190-08-07-027050	8	80	27	60	50	1,00	B	9,00	ANHX 1004...	
181076000	080A17190-10-07-027050	10	80	27	60	50	1,00	B	9,00	ANHX 1004...	
181076100	100A17190-09-07-032050	9	100	32	80	50	1,80	B	9,00	ANHX 1004...	
181076200	100A17190-12-07-032050	12	100	32	80	50	1,80	B	9,00	ANHX 1004...	

Stock item | Produto de stock | Itens de stock

Available under request (see page A-9) | Disponível sobre consulta (consulte a página A-9) | Disponible bajo consulta (mire pagina A-9)

ANHX 1004.. | Inserts | Pastilhas | Plaquitas

ANHX-LP

ANHX-LM

ANHX-LN

ANHX-LP | LM | LN

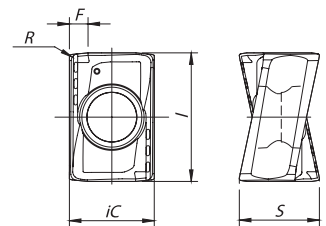
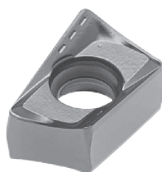

(1) Geometry code	(2) Grade code	P				M		K				N	S		Dimensions Dimensões Dimensiones (mm)				
		PVD						UNC		PVD		iC	S	I	R	F			
		X5	T1	P4	G6	X9	G6	X5	T1	P4	G6						10	X9	G6
1111652	ANHX 100405 PNR-LP													6,60	6,20	10,00	0,50	0,85	
1112106	ANHX 100408 PNR-LP													6,60	6,20	10,00	0,80	0,60	
1111908	ANHX 100412 PNR-LP													6,60	6,20	10,00	1,20	0,30	
1112005	ANHX 100405 PNER-LM													6,60	6,20	10,00	0,50	0,85	
1112162	ANHX 100408 PNER-LM													6,60	6,20	10,00	0,80	0,60	
1112103	ANHX 100412 PNER-LM													6,60	6,20	10,00	1,20	0,30	
1111997	ANHX 100405 PNFR-LN													6,60	6,20	10,00	0,50	0,85	
1112102	ANHX 100412 PNR-LN													6,60	6,20	10,00	1,20	0,30	

First choice | Primeira opção | 1ª opción Stock item | Produto de stock | Itens de stock

Available under request (see page A-9) | Disponível sobre consulta (consulte a página A-9) | Disponible bajo consulta (mire pagina A-9)

Insert order code = (1) Geometry Code + (2) Grade Code

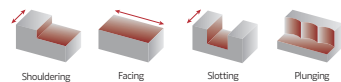

Weldon Shank
 $K_r = 90^\circ$ | $\gamma_p = -7^\circ (-6^\circ \times)$

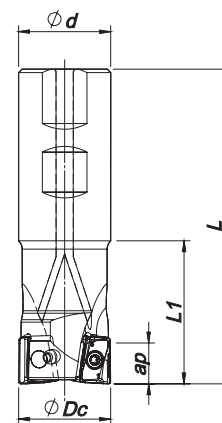

Order code Código	Reference Referência Referencia		Dimensions Dimensões Dimensiones (mm)				Kg	Specifications	Insert Pastilha Inserto	Stock
			ØDc	Ød	L	L1		Ap max (mm)		
181075000	014W17190-01-06-016090*	1	14	16	90	23	0,188	9,00	ANHX 1004...	
181101400	016W17190-02-06-016090*	2	16	16	90	25	0,123	9,00	ANHX 1004...	
181096800	016W17190-02-06-016150*	2	16	16	150	25	0,190	9,00	ANHX 1004...	
181075200	018W17190-02-06-016090*	2	18	16	90	23	0,125	9,00	ANHX 1004...	
181071400	020W17190-02-06-020100*	2	20	20	100	30	0,210	9,00	ANHX 1004...	
181071500	020W17190-03-06-020100*	3	20	20	100	30	0,206	9,00	ANHX 1004...	
181074400	025W17190-02-06-025115*	2	25	25	115	35	0,391	9,00	ANHX 1004...	
181074500	025W17190-03-06-025115*	3	25	25	115	35	0,387	9,00	ANHX 1004...	
181074600	032W17190-03-06-032125*	3	32	32	125	40	0,701	9,00	ANHX 1004...	
181074700	032W17190-04-06-032125*	4	32	32	125	40	0,698	9,00	ANHX 1004...	
181074800	040W17190-04-07-032130	4	40	32	130	40	0,780	9,00	ANHX 1004...	
181074900	040W17190-05-07-032130	5	40	32	130	40	0,777	9,00	ANHX 1004...	

Stock item | Produto de stock | Itens de stock

Available under request (see page A-9) | Disponível sobre consulta (consulte a página A-9) | Disponible bajo consulta (mire pagina A-9)

SPARE PARTS | Complementos | Repuestos

Cutter ØDc	Order separately				Order separately	
	Insert Screw	Key (Torx)	Key (Torx - Nm)	Torque Value	Screw	DIN 6368 Wrench
W17190 - 14 - 40	P0300800	XT09	DT0914	1,4	-	-
A17190 - 40 - 63	P0300800	XT09	DT0914	1,4	-	-
A17190 - 80	P0300800	XT09	DT0914	1,4	J0123510	SD6368-12
A17190 - 100	P0300800	XT09	DT0914	1,4	J0164110	SD6368-16

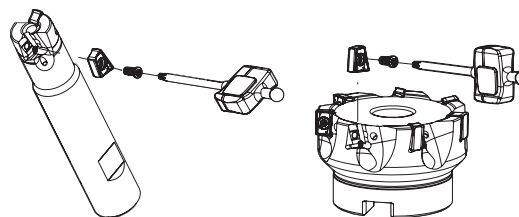

Note: The toolholder is supplied with the XT/PT key. To order the DT key please check the page A-241.
 Check the procedures for the clamping screws on the page A-241.

GRADES SELECTION GUIDE | Guia para selecção de graus | Tabla para selección de calidades

ISO	PSM	Material	HB (Brinell)	Grades					
				← Wear Resistance				Toughness →	
				PH0910	PHP910	PHP920	PHP930	PHH930	PH7740
P	1	Unalloyed Steel	125-220	●	●	●	●	●	●
	2	Low-Alloyed Steel	220-280		●	●	●		●
	3	High-Alloyed Steel	280-380		●	●	●		●
M	4	SS - Ferritic / Martensitic	200-330					●	●
	5	SS - Austenitic	200-330					●	●
	6	SS - Austenitic-ferritic (Duplex)	230-260					●	●
K	7	Malleable Cast Iron	130-230		●	●	●		●
	8	Grey Cast Iron	180-245		●	●	●		●
	9	Nodular Cast iron	160-250		●	●	●		●
N	10	Aluminium and Non Ferrous	30-130	●					
S	11	Heat Resistant Super Alloys	200-320					●	●

- Good Conditions
- Average Conditions
- Difficult Conditions

RECOMMENDED CUTTING CONDITIONS | Condições de corte recomendadas | Condiciones de corte recomendables

ISO	PSM	Material	HB (Brinell)	Vc (m/min)						Feed fz (mm/t)		
				← Wear Resistance			Toughness →			ANH... LP	ANH... LM	ANH... LN
				PH0910	PHP910	PHP920	PHP930	PHH930	PH7740			
P	1	Unalloyed Steel	125-220	-	180-250	180-250	160-230	-	140-200	0,08-0,20	0,08-0,20	-
	2	Low-Alloyed Steel	220-280	-	160-240	160-230	140-210	-	130-180	0,08-0,20	0,08-0,15	-
	3	High-Alloyed Steel	280-380	-	140-230	140-220	120-200	-	100-170	0,08-0,15	0,08-0,15	-
M	4	SS - Ferritic / Martensitic	200-330	-	-	-	-	140-210	130-180	-	0,08-0,20	-
	5	SS - Austenitic	200-330	-	-	-	-	120-170	110-160	-	0,08-0,15	-
	6	SS - Austenitic-ferritic (Duplex)	230-260	-	-	-	-	100-150	90-150	-	0,08-0,15	-
K	7	Malleable Cast Iron	130-230	-	180-300	160-270	150-250	-	140-220	0,08-0,25	0,08-0,20	-
	8	Grey Cast Iron	180-245	-	160-250	140-250	140-230	-	120-210	0,08-0,20	0,08-0,20	-
	9	Nodular Cast iron	160-250	-	150-210	120-210	100-200	-	100-190	0,08-0,20	0,08-0,15	-
N	10	Aluminium and Non Ferrous	30-130	100-2000	-	-	-	-	-	-	-	0,08-0,20
S	11	Heat Resistant Super Alloys	200-320	-	-	-	-	30-110	30-100	-	0,08-0,15	-

(Note 1) Cutting conditions $a_e/D_c=70\%$.

(Note 2)

Operation	a_e	Vc & fz	a_p (mm)
Slotting	100%	<20%	2,0-3,5
Shouldering	<50%	>8%	3,0-6,0
	≤25%	>12%	6,0-8,5

(Note 3)

It's possible to occur vibrations in certain cases. Please reduce depth of cut and / or reduce cutting conditions in following cases:

- When using long shank;
- When using long tool overhang with arbor type;
- When application has poor clamping rigidity or when using a low rigidity machine.

CHIP-BREAKER SELECTION GUIDE | Guia de selecção do quebra- aparas | Guía de selección del rompevirutas

ISO	PSM	Material	HB (Brinell)	Chip Breaker Application	
				1 st choice	Difficult Operations
P	1	Unalloyed Steel	125-220	ANHX 10... LM	ANHX 10... LP
	2	Low-Alloyed Steel	220-280	ANHX 10... LM	ANHX 10... LP
	3	High-Alloyed Steel	280-380	ANHX 10... LM	ANHX 10... LP
M	4	SS - Ferritic / Martensitic	200-330	ANHX 10... LM	-
	5	SS - Austenitic	200-330	ANHX 10... LM	-
	6	SS - Austenitic-ferritic (Duplex)	220-260	ANHX 10... LM	-
K	7	Malleable Cast Iron	130-230	ANHX 10... LM	ANHX 10... LP
	8	Grey Cast Iron	180-245	ANHX 10... LM	ANHX 10... LP
	9	Nodular Cast iron	160-250	ANHX 10... LP	-
N	10	Aluminium and Non Ferrous	30-130	ANHX 10... LN	-
S	11	Heat Resistant Super Alloys	200-320	ANHX 10... LM	-

PLUNGING | Mergulho | Plunge

L < 3Dc	L > 3Dc	S max.
f _Z (mm/t)		
0,10-0,20	0,10-0,14	$S_{max} = \sqrt{Dc \cdot Dr - Dr^2}$

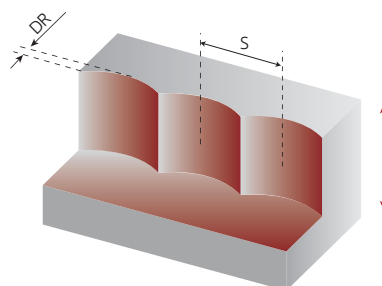

S max and DR corresponding cutting diameter Dc (mm)											
DR (mm)	Dc (mm)										
	14	16	18	20	25	32	40	50	63	80	100
1,0	3,6	3,9	4,1	4,4	4,9	5,6	6,2	7,0	7,9	8,9	9,9
2,0	4,9	5,3	5,7	6,0	6,8	7,7	8,7	9,8	11,0	12,5	14,0
3,0	5,7	6,2	6,7	7,1	8,1	9,3	10,5	11,9	13,4	15,2	17,1

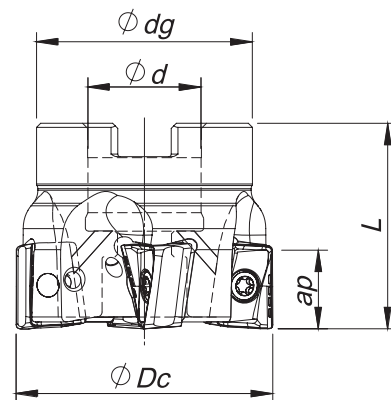
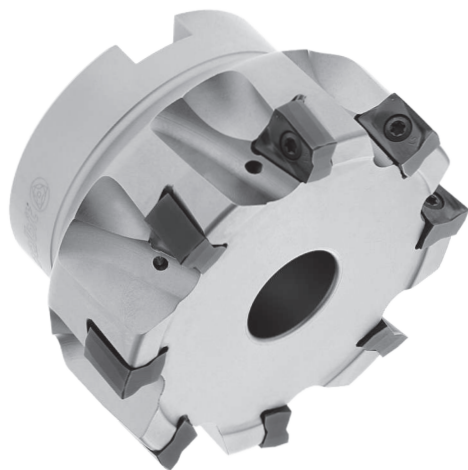

Arbor Mounting

$K_r = 90^\circ$ | $\gamma_p = -6^\circ$

Order code Código	Reference Referência Referencia		Dimensions Dimensões Dimensiones (mm)				Kg	Specifications		Insert Pastilha Inserto	Stock
			ϕDc	ϕd	ϕDg	L		Arbor Type	Ap max		
181116400	040A17590-04-06-016040	4	40	16	32	40	0,17	A	11,00	ANHX 1206...	
181114500	050A17590-05-06-022040	5	50	22	42	40	0,30	A	11,00	ANHX 1206...	
181115900	050A17590-06-06-022040	6	50	22	42	40	0,30	A	11,00	ANHX 1206...	
181116500	063A17590-05-06-022040	5	63	22	52	40	0,55	A	11,00	ANHX 1206...	
181116600	063A17590-07-06-022040	7	63	22	52	40	0,52	A	11,00	ANHX 1206...	
181116700	080A17590-08-06-027050	8	80	27	60	50	1,10	A	11,00	ANHX 1206...	
181116800	080A17590-10-06-027050	10	80	27	60	50	1,10	A	11,00	ANHX 1206...	
181116900	100A17590-12-06-032050	12	100	32	80	50	1,65	B	11,00	ANHX 1206...	
181117000	125A17590-14-06-040063	14	125	40	90	63	3,16	B	11,00	ANHX 1206...	

Stock item | Produto de stock | Itens de stock

Available under request (see page A-9) | Disponível sobre consulta (consulte a página A-9) | Disponible bajo consulta (mire pagina A-9)

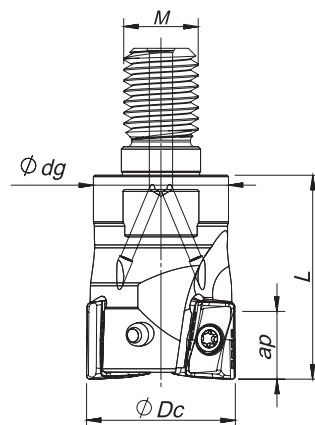

Threaded Coupling

$K_r = 90^\circ$ | $\gamma_p = -6^\circ$

Order code Código	Reference Referência Referencia		Dimensions Dimensões Dimensiones (mm)				Kg	Specifications		Insert Pastilha Inserto	Stock
			ϕDc	ϕM	ϕdg	L		Ap max			
181117100	025R17590-02-06-M12035	2	25	M12	21	35	0,09	11,00	ANHX 1206...		
181117200	032R17590-03-06-M16043	3	32	M16	29	43	0,20	11,00	ANHX 1206...		
181117300	042R17590-04-06-M16043	4	42	M16	29	43	0,26	11,00	ANHX 1206...		

Stock item | Produto de stock | Itens de stock

Available under request (see page A-9) | Disponível sobre consulta (consulte a página A-9) | Disponible bajo consulta (mire pagina A-9)

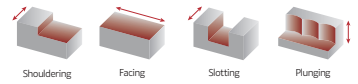

Weldon Shank
 $K_r = 90^\circ$ | $\gamma_p = -6^\circ$

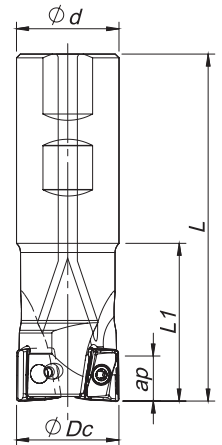

Order code Código	Reference Referência Referencia		Dimensions Dimensões Dimensiones (mm)				Kg	Specifications		Insert Pastilha Inserto	Stock
			ØDc	Ød	L	L1		Ap max			
181116000	025W17590-02-06-025110	2	25	25	110	35	0,37	11,00	ANHX 1206...		
181120600	032W17590-03-06-032150	3	32	32	150	35	0,84	11,00	ANHX 1206...		
181116100	040W17590-04-06-032150	4	40	32	150	40	0,88	11,00	ANHX 1206...		

Stock item | Produto de stock | Itens de stock

Available under request (see page A-9) | Disponível sobre consulta (consulte a página A-9) | Disponible bajo consulta (mire pagina A-9)

A
MILLING
Overview
Face milling
Hifed milling
Shoulder milling
Profile milling
Hardmill
Center & Chamfer
Spot face
Spare Parts
Technical Data
End Mills



Cylindrical Shank
 $K_r = 90^\circ$ | $\gamma_p = -6^\circ$

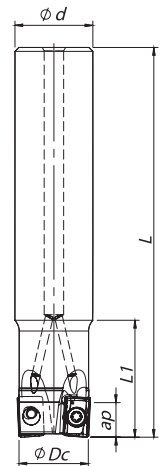

Order code Código	Reference Referência Referencia		Dimensions Dimensões Dimensiones (mm)				Kg	Specifications		Insert Pastilha Inserto	Stock
			ØDc	Ød	L	L1		Ap max			
181116300	026E17590-02-06-025200	2	26	25	200	40	0,66	11,00	ANHX 1206...		
181116200	033E17590-03-06-032250	3	33	32	250	40	1,40	11,00	ANHX 1206...		

Stock item | Produto de stock | Itens de stock

Available under request (see page A-9) | Disponível sobre consulta (consulte a página A-9) | Disponible bajo consulta (mire pagina A-9)

SPARE PARTS | Complementos | Repuestos

Cutter ØDc	Order separately			
	Insert Screw	Key (Torx)	Key (Torx - Nm)	Torque Value
E17590 - 26 - 33	P0350904	XT10	DT1020	2,0
A17590 - 40 - 100	P0350904	XT10	DT1020	2,0
A17590 - 125	P0350904	PT10	DT1020	2,0
R17590 - 25 - 42	P0350904	XT10	DT1020	2,0
W17590 - 25-40	P0350904	XT10	DT1020	2,0

Note: The toolholder is supplied with the XT/PT key. To order the DT key please check the page A-241.
Check the procedures for the clamping screws on the page A-241.

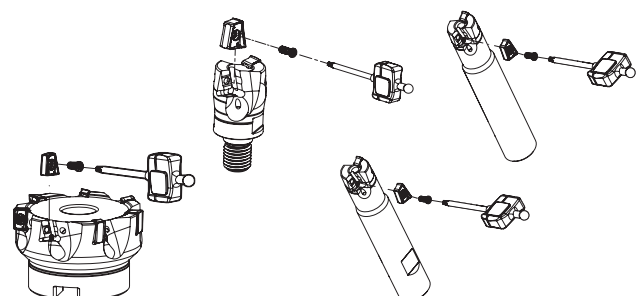

PLUS 17590

ANHX 1206.. | Inserts | Pastilhas | Plaquetas

ANHX-LS

ANHX-MP

ANHX-LS | MP

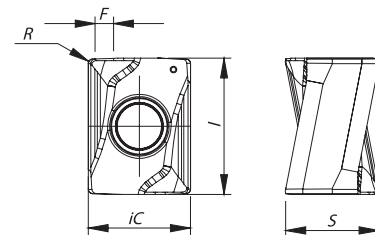
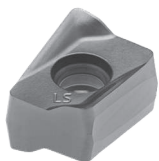

	(2) Grade code	P					M			K					S			Dimensions Dimensões Dimensiones (mm)				
		CVD	PVD				PVD			PVD					PVD							
(1) Geometry code	ISO Reference	T9	G4	T1	P3	G6	P3	X9	G6	L6	G4	T1	P3	G6	P3	X9	G6	iC	S	I	R	F
1112474	ANHX 120604 PNER-LS		⊗		⊗	⊗	⊗		⊗		⊗		⊗	⊗	⊗		⊗	9,0	8,3	12,0	0,4	1,6
1112237	ANHX 120608 PNER-LS		⊗			⊗	⊗		⊗		⊗		⊗		⊗		⊗	9,0	8,3	12,0	0,8	1,2
1112429	ANHX 120616 PNER-LS		⊗		⊗	⊗	⊗		⊗		⊗		⊗	⊗	⊗		⊗	9,0	8,3	12,0	1,6	0,4
1112473	ANHX 120604 PNSR-MP			⊗		⊗			⊗	⊗	⊗	⊗		⊗				9,0	8,3	12,0	0,4	1,6
1112238	ANHX 120608 PNSR-MP	⊗		⊗		⊗			⊗	⊗	⊗	⊗		⊗				9,0	8,3	12,0	0,8	1,2
1112430	ANHX 120616 PNSR-MP		⊗	⊗		⊗			⊗	⊗	⊗	⊗		⊗				9,0	8,3	12,0	1,6	0,4

⊗ First choice | Primeira opção | 1ª opción ⊗ Stock item | Produto de stock | Itens de stock ○ Available under request (see page A-9) | Disponível sobre consulta (consulte a página A-9) | Disponible bajo consulta (mire pagina A-9) Insert order code = (1) Geometry Code + (2) Grade Code
 ⊗ Stock available until sold out | Stock disponível até acabar o stock | Stock disponible hasta acabar el stock

RECOMMENDED CUTTING CONDITIONS | Condições de corte recomendadas | Condiciones de corte recomendables

ISO	PSM	Material	HB (Brinell)	Vc (m/min)							Feed fz (mm/t)	
				← Wear Resistance				Toughness →			ANHX 12... LS	ANHX 12... MP
				PH5320	PHP920	PH7920	PHH930	PH7930	PHS740	PH7740		
P	1	Unalloyed Steel	125-220	-	180-250	180-240	-	160-220	140-220	140-200	0,08-0,20	0,08-0,30
	2	Low-Alloyed Steel	220-280	-	160-230	160-220	-	140-200	120-200	130-180	0,08-0,20	0,08-0,25
	3	High-Alloyed Steel	280-380	-	140-220	140-210	-	120-190	100-190	100-170	0,08-0,15	0,08-0,20
M	4	SS - Ferritic / Martensitic	200-330	-	-	140-220	140-210	140-200	-	130-180	0,08-0,20	-
	5	SS - Austenitic	200-330	-	-	130-180	120-170	120-160	-	110-160	0,08-0,15	-
	6	SS - Austenitic-ferritic (Duplex)	230-260	-	-	120-160	100-150	100-140	-	90-150	0,08-0,15	-
K	7	Malleable Cast Iron	130-230	150-280	160-270	160-260	-	150-240	-	140-220	0,08-0,20	0,08-0,30
	8	Grey Cast Iron	180-245	160-320	140-250	140-240	-	140-230	-	120-210	0,08-0,20	0,08-0,25
	9	Nodular Cast iron	160-250	100-190	120-210	120-200	-	100-190	-	100-190	0,08-0,20	0,08-0,20
S	11	Heat Resistant Super Alloys	200-320	-	-	-	30-110	30-100	-	30-100	0,07-0,10	-

(Note 1) Cutting conditions $a_e/D_c=70\%$.

(Note 2)

Operation	a_e	Vc & fz	a_p (mm)
Slotting	100%	<20%	2,5-4,0
Shouldering	<50%	>8%	4,0-7,0
	≤25%	>12%	7,0-10,0

(Note 3)

It's possible to occur vibrations in certain cases. Please reduce depth of cut and / or reduce cutting conditions in following cases:

- When using long shank;
- When using long tool overhang with arbor type;
- When application has poor clamping rigidity or when using a low rigidity machine.

GRADES SELECTION GUIDE | Guia para selecção de graus | Tabla para selección de calidades

ISO	PSM	Material	HB (Brinell)	Grades						
				← Wear Resistance			Toughness →			
				PH5320	PHP920	PH7920	PHH930	PH7930	PHS740	PH7740
P	1	Unalloyed Steel	125-220	●	●	●	●	●	●	●
	2	Low-Alloyed Steel	220-280		●	●		●	●	●
	3	High-Alloyed Steel	280-380		●	●		●	●	●
M	4	SS - Ferritic / Martensitic	200-330				●	●		●
	5	SS - Austenitic	200-330				●	●		●
	6	SS - Austenitic-ferritic (Duplex)	230-260				●	●		●
K	7	Malleable Cast Iron	130-230	●	●	●		●		●
	8	Grey Cast Iron	180-245	●	●	●		●		●
	9	Nodular Cast iron	160-250	●	●	●		●		●
S	11	Heat Resistant Super Alloys	200-320					●		●

● Good Conditions ● Average Conditions ● Difficult Conditions

CHIP-BREAKER SELECTION GUIDE | Guia de selecção do quebra-apanas | Guía de selección del rompevirutas

ISO	PSM	Material	HB (Brinell)	Chip Breaker Application	
				1 st choice	Difficult Operations
P	1	Unalloyed Steel	125-220	ANHX 12... LS	ANHX 12... MP
	2	Low-Alloyed Steel	220-280	ANHX 12... MP	-
	3	High-Alloyed Steel	280-380	ANHX 12... MP	-
M	4	SS - Ferritic / Martensitic	200-330	ANHX 12... LS	-
	5	SS - Austenitic	200-330	ANHX 12... LS	-
	6	SS - Austenitic-ferritic (Duplex)	220-260	ANHX 12... LS	-
K	7	Malleable Cast Iron	130-230	ANHX 12... LS	ANHX 12... MP
	8	Grey Cast Iron	180-245	ANHX 12... MP	-
	9	Nodular Cast iron	160-250	ANHX 12... MP	-
S	11	Heat Resistant Super Alloys	200-320	ANHX 12... LS	-

PLUNGING | Mergulho | Plunge

L ≤ 3Dc	L > 3Dc	S max.
f _z (mm/t)		
0,10-0,20	0,10-0,14	$S_{max} = \sqrt{DC \cdot Dr - Dr^2}$

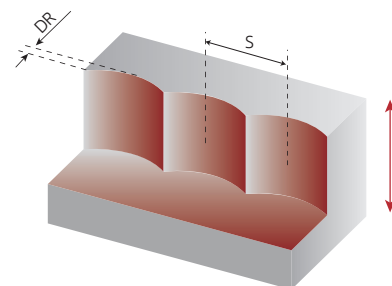

S max and DR corresponding cutting diameter Dc (mm)							
DR (mm)	Dc (mm)						
	32	40	50	63	80	100	125
1,0	5,6	6,2	7,0	7,9	8,9	9,9	11,1
2,0	7,7	8,7	9,8	11,0	12,5	14,0	15,7
3,0	9,3	10,5	11,9	13,4	15,2	17,1	19,1

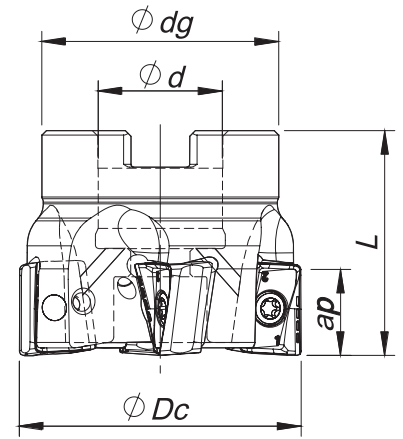
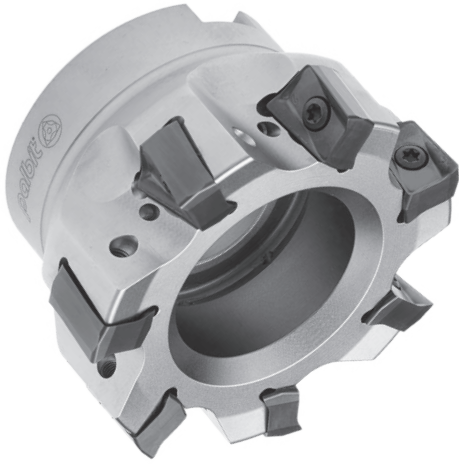

Arbor Mounting

$K_r = 90^\circ$ | $\gamma_p = -4^\circ$

Order code Código	Reference Referência Referencia		Dimensions Dimensões Dimensiones (mm)				Kg	Specifications		Insert Pastilha Inserto	Stock
			ϕDc	ϕd	ϕDg	L		Arbor Type	Ap max		
181067600	050A18190-03-04-022040	3	50	22	42	40	0,28	A	15,0	ANHX 1607...	
181067700	050A18190-04-04-022040	4	50	22	42	40	0,27	A	15,0	ANHX 1607...	
181067800	063A18190-04-04-022040	4	63	22	52	40	0,51	A	15,0	ANHX 1607...	
181067900	063A18190-06-04-022040	6	63	22	52	40	0,48	A	15,0	ANHX 1607...	
181068000	080A18190-05-04-027050	5	80	27	60	50	0,88	B	15,0	ANHX 1607...	
181051800	080A18190-07-04-027050	7	80	27	60	50	0,36	B	15,0	ANHX 1607...	
181068100	100A18190-05-04-032050	5	100	32	80	50	1,60	B	15,0	ANHX 1607...	
181068200	100A18190-08-04-032050	8	100	32	80	50	1,59	B	15,0	ANHX 1607...	
181068300	125A18190-07-04-040063	7	125	40	90	63	2,93	B	15,0	ANHX 1607...	
181068400	125A18190-10-04-040063	10	125	40	90	63	2,89	B	15,0	ANHX 1607...	
181068500	160A18190-08-04-U040063	8	160	40	110	63	4,29	C	15,0	ANHX 1607...	
181068600	160A18190-12-04-U040063	12	160	40	110	63	4,29	C	15,0	ANHX 1607...	

Stock item | Produto de stock | Itens de stock

Available under request (see page A-9) | Disponível sobre consulta (consulte a página A-9) | Disponible bajo consulta (mire pagina A-9)

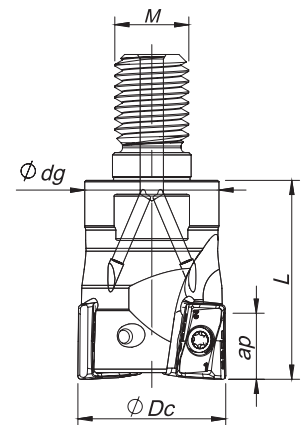

Threaded Coupling

$K_r = 90^\circ$ | $\gamma_p = -4^\circ$

Order code Código	Reference Referência Referencia		Dimensions Dimensões Dimensiones (mm)				Kg	Specifications		Insert Pastilha Inserto	Stock
			ϕDc	ϕM	ϕdg	L		Ap max			
181082800	032R18190-02-04-M16043	2	32	M16	29	43	0,20	15,0	ANHX 1607...		
181082900	040R18190-03-04-M16043	3	40	M16	29	43	0,24	15,0	ANHX 1607...		

Stock item | Produto de stock | Itens de stock

Available under request (see page A-9) | Disponível sobre consulta (consulte a página A-9) | Disponible bajo consulta (mire pagina A-9)

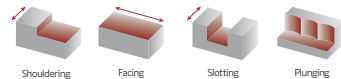

Weldon Shank
 $K_r = 90^\circ$ | $\gamma_p = -4^\circ$

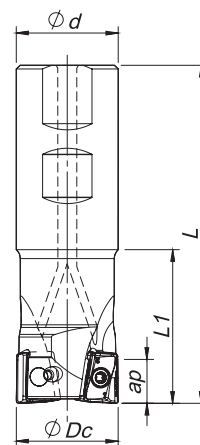

Order code Código	Reference Referência Referencia		Dimensions Dimensões Dimensiones (mm)				Kg	Specifications	Insert Pastilha Inserto	Stock
			ϕDc	ϕd	L	L1		Ap max		
181051600	032W18190-02-04-032110	2	32	32	110	50	0,66	15,0	ANHX 1607...	
181067500	040W18190-03-04-032115	3	40	32	115	40	0,66	15,0	ANHX 1607...	

Stock item | Produto de stock | Itens de stock

Available under request (see page A-9) | Disponível sobre consulta (consulte a página A-9) | Disponible bajo consulta (mire pagina A-9)

ANHX 1607.. | Inserts | Pastilhas | Plaquetas

ANHX-LP

ANHX-MP

ANHX-LN

ANHX-LP | MP | LN

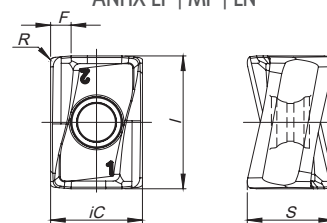

(1) Geometry code	(2) Grade code ISO Reference	P						K					N	Dimensions Dimensões Dimensiones (mm)				
		CVD	PVD					PVD					UNC					
		T9	G1	G4	T1	P3	P4	G1	G4	T1	P3	P4	10					
1111519	ANHX 160708 PNR-LP													11,20	10,80	16	0,8	1,4
1111596	ANHX 160712 PNR-LP													11,20	10,50	16	1,2	1,2
1111595	ANHX 160708 PNER-MP													11,20	10,80	16	0,8	1,4
1111598	ANHX 160712 PNER-MP													11,20	10,50	16	1,2	1,2
1111659	ANHX 160708 PNFR-LN													11,20	10,80	16	0,8	1,4
1111597	ANHX 160712 PNFR-LN													11,20	10,50	16	1,2	1,2

First choice | Primeira opção | 1ª opción

Stock item | Produto de stock | Itens de stock

Available under request (see page A-9) | Disponível sobre consulta (consulte a página A-9) | Disponible bajo consulta (mire pagina A-9)

Insert order code = (1) Geometry Code + (2) Grade Code

Stock available until sold out | Stock disponível até acabar o stock | Stock disponible hasta acabar el stock

PLUS 18190

SPARE PARTS | Complementos | Repuestos

Cutter ØDc	Insert Screw	Key (Torx)	Order separately		Order separately	
			Key (Torx - Nm)	Torque Value	Screw	DIN 6368 Wrench
W18190 - 32 - 40	P0401200	XT15	DT1530	3,0	-	-
R18190 - 32 - 40	P0401200	XT15	DT1530	3,0	-	-
A18190 - 50 - 63	P0401200	XT15	DT1530	3,0	-	-
A18190 - 80	P0401200	XT15	DT1530	3,0	J0123510	SD6368-12
A18190 - 100	P0401200	XT15	DT1530	3,0	J0164110	SD6368-16
A18190 - 125	P0401200	PT15	DT1530	3,0	J0204610	SD6368-20
A18190 - 160	P0401200	PT15	DT1530	3,0	-	-

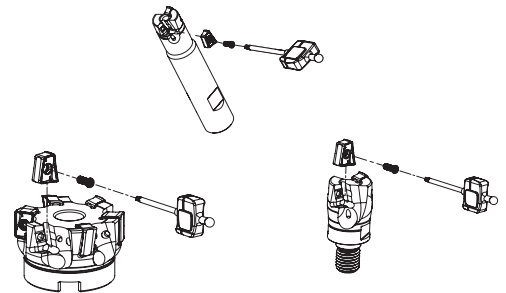

Note: The toolholder is supplied with the XT/PT key. To order the DT key please check the page A-241.
Check the procedures for the clamping screws on the page A-241.

RECOMMENDED CUTTING CONDITIONS | Condições de corte recomendadas | Condiciones de corte recomendadas

ISO	PSM	Material	HB (Brinell)	Vc (m/min)							Feed fz (mm/t)		
				← Wear Resistance Toughness →							ANHX 12... LP	ANHX 12... MP	ANHX 12... LN
				PH0910	PH7910	PHP920	PH7920	PHP930	PH7930	PHS740			
P	1	Unalloyed Steel	125-220	-	180-250	180-250	180-240	160-230	160-220	140-220	0,10-0,25	0,10-0,25	-
	2	Low-Alloyed Steel	220-280	-	160-230	160-230	160-220	140-210	140-200	120-200	0,10-0,25	0,10-0,25	-
	3	High-Alloyed Steel	280-380	-	140-220	140-220	140-210	120-200	120-190	100-190	0,10-0,20	0,10-0,20	-
K	7	Malleable Cast Iron	130-230	-	180-300	160-270	160-260	150-250	150-240	-	0,10-0,25	0,10-0,25	-
	8	Grey Cast Iron	180-245	-	160-250	140-250	140-240	140-230	140-230	-	0,10-0,25	0,10-0,25	-
	9	Nodular Cast iron	160-250	-	150-200	120-210	120-200	100-200	100-190	-	0,10-0,20	0,10-0,25	-
N	10	Aluminium and Non Ferrous	30-130	100-2000	-	-	-	-	-	-	-	-	0,10-0,40

(Note 1)
Cutting conditions $a_e/D_c=70\%$.

(Note 2)

Operation	a_e	Vc & fz	a_p (mm)
Slotting	100%	<20%	2,0-4,5
Shouldering	<50%	>8%	6,0-8,0
	≤25%	>12%	8,0-15,0

(Note 3)

It's possible to occur vibrations in certain cases. Please reduce depth of cut and / or reduce cutting conditions in following cases:

- When using long shank;
- When using long tool overhang with arbor type;
- When application has poor clamping rigidity or when using a low rigidity machine.

GRADES SELECTION GUIDE | Guia para selecção de graus | Guía para selección de calidades

ISO	PSM	Material	HB (Brinell)	Grades						
				← Wear Resistance				Toughness →		
				PH0910	PH7910	PHP920	PH7920	PHP930	PH7930	PHS740
P	1	Unalloyed Steel	125-220	●	✓	✓	✓	✓	✓	✓
	2	Low-Alloyed Steel	220-280		✓	✓	✓	✓	✓	✓
	3	High-Alloyed Steel	280-380		✓	✓	✓	✓	✓	✓
K	7	Malleable Cast Iron	130-230		✓	✓	✓	✓	✓	
	8	Grey Cast Iron	180-245		✓	✓	✓	✓	✓	
	9	Nodular Cast iron	160-250		✓	✓	✓	✓	✓	
N	10	Aluminium and Non Ferrous	30-130	✓						

- Good Conditions
- Average Conditions
- Difficult Conditions

CHIP-BREAKER SELECTION GUIDE | Guia para aplicações do quebra-apanas | Guía para aplicación del rompevirutas

ISO	PSM	Material	HB (Brinell)	Chip Breaker Application	
				1 st choice	Difficult Operations
P	1	Unalloyed Steel	125-220	ANHX 16... LP	ANHX 16... MP
	2	Low-Alloyed Steel	220-280	ANHX 16... LP	ANHX 16... MP
	3	High-Alloyed Steel	280-380	ANHX 16... LP	ANHX 16... MP
K	7	Malleable Cast Iron	130-230	ANHX 16... LP	ANHX 16... MP
	8	Grey Cast Iron	180-245	ANHX 16... LP	ANHX 16... MP
	9	Nodular Cast iron	160-250	ANHX 16... LP	ANHX 16... MP
N	10	Aluminium and Non Ferrous	30-130	ANHX 16... LN	-

PLUNGING | Mergulho | Plunge

L < 3Dc	L > 3Dc	S max.
f _z (mm/t)		
0,10-0,20	0,10-0,14	$S_{max} = \sqrt{D_c \cdot DR - DR^2}$

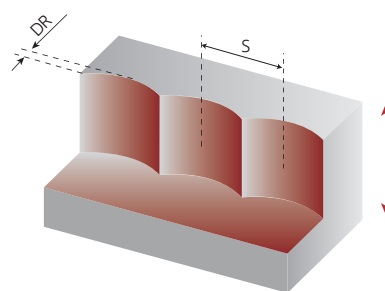

S max and DR corresponding cutting diameter Dc (mm)								
DR (mm)	Dc (mm)							
	32	40	50	63	80	100	125	160
1,0	5,6	6,2	7,0	7,9	8,9	9,9	11,1	12,6
2,0	7,7	8,7	9,8	11,0	12,5	14,0	15,7	17,8
3,0	9,3	10,5	11,9	13,4	15,2	17,1	19,1	21,7
4,0	10,6	12,0	13,6	15,4	17,4	19,6	22,0	25,0
5,0	11,6	13,2	15,0	17,0	19,4	21,8	24,5	27,8

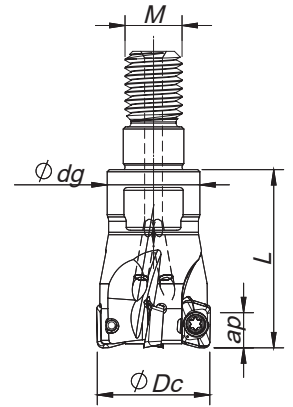

Threaded Coupling

$K_r=90^\circ$ | $\gamma_p=+4^\circ$

Order code Código	Reference Referência Referencia		Dimensions Dimensões Dimensiones (mm)				Kg	Max ap (mm)			Insert Pastilha Inserto	Stock
			ϕDc	ϕM	ϕdg	L		LP LN	HF	MH		
181120400	010R20090-02-04-M06020	2	10	M6	9,8	20	0,01	4,00	0,30	2,00	XP... 0602...	
181112800	011R20090-02-04-M06020	2	11	M6	9,8	20	0,01	4,00	0,30	2,00	XP... 0602...	
181120500	012R20090-03-04-M06020	3	12	M6	9,8	20	0,02	4,00	0,30	2,00	XP... 0602...	
181112900	013R20090-03-04-M06020	3	13	M6	9,8	20	0,02	4,00	0,30	2,00	XP... 0602...	
181087500	016R20090-04-04-M08025	4	16	M8	13,0	25	0,03	4,00	0,30	2,00	XP... 0602...	
181113000	017R20090-04-04-M08025	4	17	M8	13,0	25	0,04	4,00	0,30	2,00	XP... 0602...	
181087600	020R20090-05-04-M10030	5	20	M10	18,0	30	0,06	4,00	0,30	2,00	XP... 0602...	
181087700	025R20090-07-04-M12030	7	25	M12	21,0	30	0,09	4,00	0,30	2,00	XP... 0602...	
181087800	032R20090-08-04-M16035	8	32	M16	29,0	35	0,19	4,00	0,30	2,00	XP... 0602...	

Stock item | Produto de stock | Itens de stock

Available under request (see page A-8) | Disponível sobre consulta (consulte a página A-8) | Disponible bajo consulta (mire página A-8)

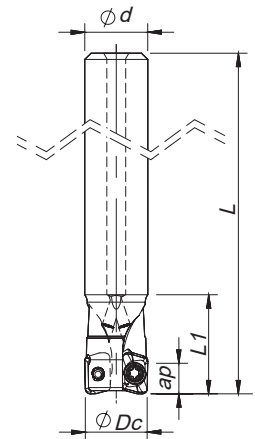

Cylindrical Shank

$K_r=90^\circ$ | $\gamma_p=+4^\circ$

Order code Código	Reference Referência Referencia		Dimensions Dimensões Dimensiones (mm)				Kg	Max ap (mm)			Insert Pastilha Inserto	Stock
			ϕDc	ϕd	L	L1		LP LN	HF	MH		
181087100	010E20090-02-04-010055	2	10	10	55	16	0,03	4,00	0,30	2,00	XP... 0602...	
181108300	010E20090-02-04-010100	2	10	10	100	25	0,03	4,00	0,30	2,00	XP... 0602...	
181087200	012E20090-02-04-012080	2	12	12	80	17	0,06	4,00	0,30	2,00	XP... 0602...	
181109900	012E20090-03-04-012120	3	12	12	120	30	0,06	4,00	0,30	2,00	XP... 0602...	
181087300	016E20090-03-04-016090	3	16	16	90	20	0,12	4,00	0,30	2,00	XP... 0602...	
181087400	016E20090-04-04-016090	4	16	16	90	20	0,11	4,00	0,30	2,00	XP... 0602...	
181097100	017E20090-05-04-016090	5	17	16	90	35	0,11	4,00	0,30	2,00	XP... 0602...	
181097200	021E20090-05-04-020090	5	21	20	90	35	0,13	4,00	0,30	2,00	XP... 0602...	

Stock item | Produto de stock | Itens de stock

Available under request (see page A-8) | Disponível sobre consulta (consulte a página A-8) | Disponible bajo consulta (mire página A-8)



XP... 0602... || Inserts | Pastilhas | Plaquetas

XPET-LP

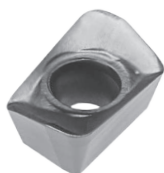

XPET-LN

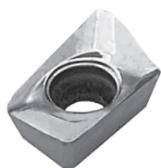

XPET-LP | LN

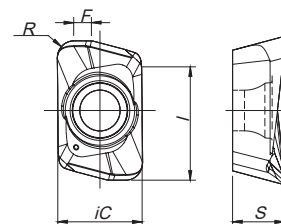

XPET-HF
(HiFeed geometry)

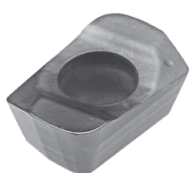

XPET-HF

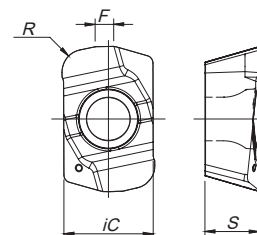

XPHW-MH
(finishing geometry)

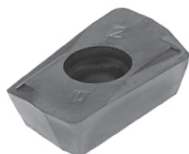

XPHW-MH

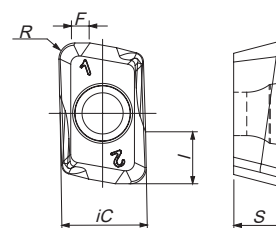

		P				M	K	N	S	H		Dimensions Dimensões Dimensiones (mm)					
		PVD				CVD	CVD	PVD	UNC	PVD	PVD						
		X4	X6	T1	P4	X9	T1	P4	10	X9	X4						X6
⁽¹⁾ Geometry code	⁽²⁾ Grade code ISO Reference	PHH603	PHH910	PHP920	PHP930	PHH930	PHP920	PHP930	PH0910	PHH930	PHH603	PHH910	iC	S	I	R	F
1112002	XPET 060204 PDER-LP			⊗	⊗	⊗	⊗	⊗		⊗			3,90	2,40	5,30	0,40	0,80
1112003	XPET 060208 PDER-LP			⊗	⊗	⊗	⊗	⊗		⊗			3,90	2,40	5,30	0,80	0,70
1112004	XPET 060216 PDER-LP			⊗	⊗		⊗	⊗					3,90	2,40	5,30	1,60	0,60
1112579	XPET 060202 PDFR-LN								⊗				3,90	2,40	5,10	0,20	0,95
1112580	XPET 060204 PDFR-LN								⊗				3,90	2,40	5,10	0,40	0,80
1112049	XPET 060210 ZER-HF			⊗	⊗	⊗	⊗	⊗		⊗			3,90	2,40	-	1,00	0,80
1112259	XPHW 060208 ZER-MH	⊗	⊗								⊗	⊗	3,90	2,40	2,40	0,80	0,70

⊗ First choice | Primeira opção | 1ª opción ⊗ Stock item | Produto de stock | Itens de stock ○ Available under request (see page A-9) | Disponível| sobre consulta (consulte a página A-9) | Disponible bajo consulta (mire pagina A-9) Insert order code = (1) Geometry Code + (2) Grade Code

LINEPRO 20090

A

SPARE PARTS | Complementos | Repuestos

MILLING

Cutter ØDc	Insert Screw	Key (Torx)	Order separately	
			Key (Torx - Nm)	Torque Value
E20090 - 10	P0180300	XT06IP	DT0606IP	0,6
E20090 - 12-16	P0180400	XT06IP	DT0606IP	0,6
R20090 - 12-16	P0180400	XT06IP	DT0606IP	0,6

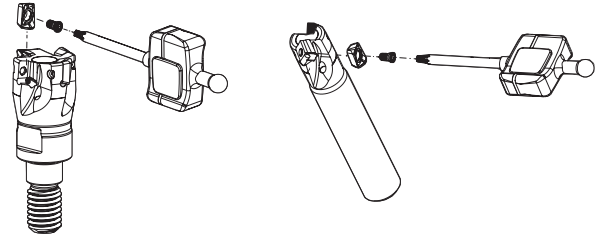

Note: The toolholder is supplied with the XT/PT key. To order the DT key please check the page A-241. Check the procedures for the clamping screws on the page A-241.

Overview

Face milling

Hi-feed milling

GRADES SELECTION GUIDE | Guia para selección de graus | Tabla para selección de calidades

ISO	PSM	Material	HB (Brinell)	Grades					
				← Wear Resistance			Toughness →		
				PH0910	PHH603	PHH910	PHP920	PHP930	PHH930
P	1	Unalloyed Steel	125-220	●	●	●	✓	✓	
	2	Low-Alloyed Steel	220-280			✓	✓	✓	
	3	High-Alloyed Steel	280-380		✓	✓	✓	✓	
M	4	SS - Ferritic / Martensitic	200-330						✓
	5	SS - Austenitic	200-330						✓
	6	SS - Austenitic-ferritic (Duplex)	230-260						✓
K	7	Malleable Cast Iron	130-230				✓	✓	
	8	Grey Cast Iron	180-245				✓	✓	
	9	Nodular Cast iron	160-250				✓	✓	
N	10	Aluminium and Non Ferrous	30-130	✓					
S	11	Heat Resistant Super Alloys	200-320						✓
H	12	Hardened Steels	40-55 HRC		✓	✓			

- Good Conditions
- Average Conditions
- Difficult Conditions

Center & Chamfer

Spot face

Spare Parts

Technical Data

End Mills

RECOMMENDED CUTTING CONDITIONS | Condições de corte recomendadas | Condiciones de corte recomendables

ISO	PSM	Material	HB (Brinell)	Vc (m/min)					
				← Wear Resistance				Toughness →	
				PH0910	PHH603	PHH910	PHP920	PHP930	PHH930
P	1	Unalloyed Steel	125-220	-	-	-	180-250	160-230	-
	2	Low-Alloyed Steel	220-280	-	-	160-270	160-230	140-210	-
	3	High-Alloyed Steel	280-380	-	180-310	140-230	140-220	120-200	-
M	4	SS - Ferritic / Martensitic	200-330	-	-	-	-	-	140-210
	5	SS - Austenitic	200-330	-	-	-	-	-	120-170
	6	SS - Austenitic-ferritic (Duplex)	230-260	-	-	-	-	-	100-150
K	7	Malleable Cast Iron	130-230	-	-	-	160-270	150-250	-
	8	Grey Cast Iron	180-245	-	-	-	140-250	140-230	-
	9	Nodular Cast iron	160-250	-	-	-	120-210	100-200	-
N	10	Aluminium and Non Ferrous	30-130	100-2000	-	-	-	-	-
S	11	Heat Resistant Super Alloys	200-320	-	-	-	-	-	30-110
H	12	Hardened Steels	40-55 HRC	-	70-270	70-260	-	-	-

ISO	PSM	Material	HB (Brinell)	Feed fz (mm/t)			
				XPET 06...LP	XPET 06...LN	XPET 06...HF	XPHW 06...MH
				P	1	Unalloyed Steel	125-220
2	Low-Alloyed Steel	220-280	0,05-0,07		-	0,40-0,80	0,05-0,12
3	High-Alloyed Steel	280-380	0,05-0,07		-	0,40-0,60	0,05-0,12
M	4	SS - Ferritic / Martensitic	200-330	0,05-0,07	-	0,40-0,80	-
	5	SS - Austenitic	200-330	0,05-0,07	-	0,40-0,60	-
	6	SS - Austenitic-ferritic (Duplex)	230-260	0,05-0,07	-	0,40-0,60	-
K	7	Malleable Cast Iron	130-230	0,05-0,07	-	0,40-0,80	-
	8	Grey Cast Iron	180-245	0,05-0,07	-	0,40-0,80	-
	9	Nodular Cast iron	160-250	0,05-0,07	-	0,40-0,80	-
N	10	Aluminium and Non Ferrous	30-130	-	0,05-0,07	-	-
S	11	Heat Resistant Super Alloys	200-320	0,05-0,07	-	0,40-0,60	-
H	12	Hardened Steels	40-55 HRC	-	-	-	0,03-0,10

(Note 1) Cutting conditions $a_e/D_c=70\%$.

(Note 2) It's possible to occur vibrations in certain cases. Please reduce depth of cut and / or reduce cutting conditions in following cases:

- When using long shank;
- When using long tool overhang with arbor type;
- When application has poor clamping rigidity or when using a low rigidity machine.

(Note 3) PH5... and PHS... can be used wet or dry. PH7... use only air.

(Note 4) It's possible to occur vibrations in certain cases. Please reduce depth of cut and / or reduce cutting conditions in following cases:

- When using long shank;
- When using long tool overhang with arbor type;
- When application has poor clamping rigidity or when using a low rigidity machine.

Operation	a_e	Vc & fz	a_p (mm)
Slotting	100%	<20%	1,0-3,0
Shouldering	<50%	>8%	1,0-4,0
	≤25%	>12%	1,0-4,0

LINEPRO 20090

CHIP-BREAKER SELECTION GUIDE | Guia para aplicações do quebra- aparas | Guía para aplicación del rompevirutas

ISO	PSM	Material	HB (Brinell)	Chip-Breaker Application	
				1st choice	Difficult Operations
P	1	Unalloyed Steel	125-220	XPET 06... LP/HF	-
	2	Low-Alloyed Steel	220-280	XPET 06... LP/HF	XPHW 06... MH
	3	High-Alloyed Steel	280-380	XPET 06... LP/HF	XPHW 06... MH
M	4	SS - Ferritic / Martensitic	200-330	XPET 06... LP/HF	-
	5	SS - Austenitic	200-330	XPET 06... LP/HF	-
	6	SS - Austenitic-ferritic (Duplex)	230-260	XPET 06... LP/HF	-
K	7	Malleable Cast Iron	130-230	XPET 06... LP/HF	-
	8	Grey Cast Iron	180-245	XPET 06... LP/HF	-
	9	Nodular Cast iron	160-250	XPET 06... LP/HF	-
N	10	Aluminium and Non Ferrous	30-130	XPET 06... LN	-
S	11	Heat Resistant Super Alloys	200-320	XPET 06... LP/HF	-
H	12	Hardened Steels	40-55 HRC	XPHW 06... MH	-

PROGRAMMING DATA | Dados para programação | Datos para la programación

Insert	Programming Data		
	Rp	X	b
XPET 06 HF	1,1	0,84	2,3

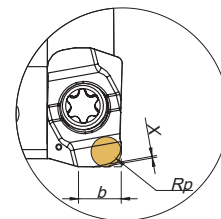

RAMPING AND HELICAL INTERPOLATION

Descida em rampa e interpolação helicoidal | Bajada en rampa e interpolación circular

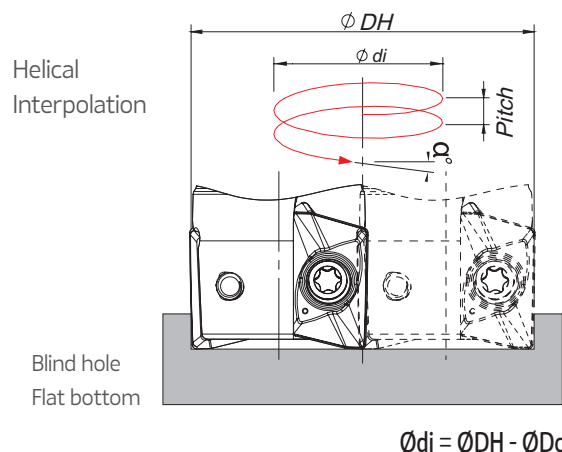
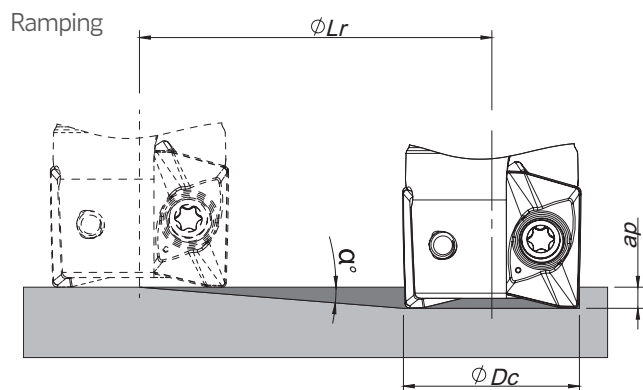

ØDc	Ramping			Helical Interpolation		
				Diameter for Blind Hole, Flat Bottom Face (1)		Max Pitch/Rev.
	Max Ramp α°	Max ap	Min Lr	ØDHmin	ØDHmax	
10	5,5	4,0	41,5	17,2 -	- 18,4	2,2 2,5
12	4,0	4,0	57,2	21,2 -	- 22,4	2,0 2,3
16	2,5	4,0	91,6	29,2 -	- 30,4	1,8 2,0
17	2,2	4,0	104,1	31,2 -	- 32,4	1,7 1,9
20	1,9	4,0	120,6	37,2 -	- 38,4	1,8 1,9
21	1,6	4,0	143,2	39,2 -	- 40,4	1,6 1,7
25	1,3	4,0	171,0	47,2 -	- 48,4	1,6 1,7
32	1,0	4,0	229,2	61,2 -	- 62,4	1,6 1,7

(1) using LP insert with radius 0,8 mm

Note: During helical interpolation do not exceed maximum pitch

When using HF insert or other different insert radius to calculate the ØDHmin and ØDHmax use the equation below:

- Minimum Diameter: $\text{ØDHmin} = 2 \times (\text{ØDc} - (R \text{ corner radius} + F \text{ width of edge wiper}))$

- Maximum Diameter: $\text{ØDHmax} = 2 \times (\text{ØDc} - R \text{ corner radius})$

(On HF insert the corner radius should be corner radius programming)

A

MILLING

Overview

Face milling

Hi-feed milling

Shoulder milling

Profile milling

Hardmill

Center & Chamfer

Spot face

Spare Parts

Technical Data

End Mills

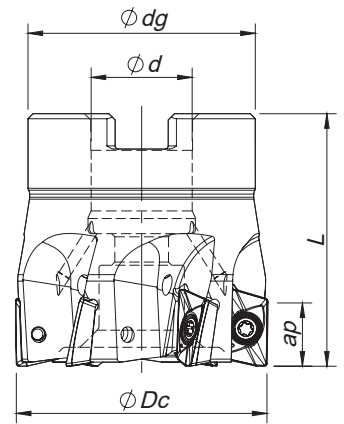
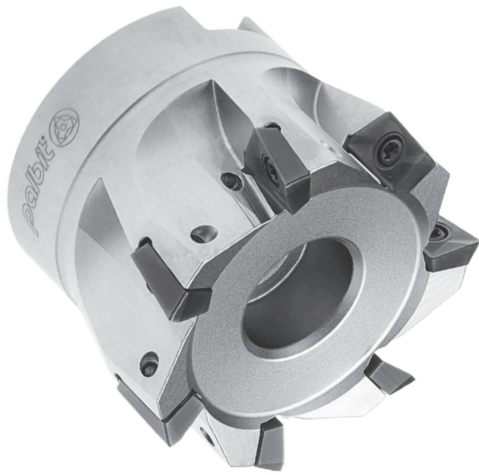

Arbor Mounting

$K_r=90^\circ$ | $\gamma_p=+8^\circ$

Order code Código	Reference Referência Referencia		Dimensions Dimensões Dimensiones (mm)				Kg	Max ap (mm)			Arbor Style	Insert Pastilha Inserto	Stock
			ϕDc	ϕd	ϕdg	L		LP/MP	HF	MH			
181088600	040A20190-06-08-016040		40	16	36	40	0,22	10,0	0,80	3,00	A	XP... 1003...	
181088700	050A20190-07-08-022040		50	22	42	40	0,31	10,0	0,80	3,00	A	XP... 1003...	
181088800	063A20190-08-08-022040		63	22	52	40	0,43	10,0	0,80	3,00	A	XP... 1003...	

Stock item | Produto de stock | Itens de stock

Available under request (see page A-8) | Disponível sobre consulta (consulte a página A-8) | Disponible bajo consulta (mire pagina A-8)

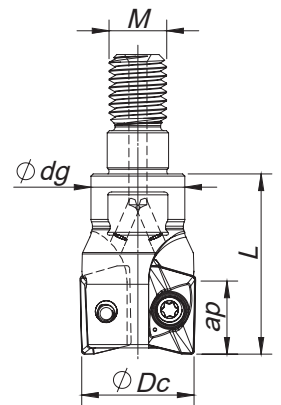

Threaded Coupling

$K_r=90^\circ$ | $\gamma_p=+5^\circ \sim +6^\circ$

Order code Código	Reference Referência Referencia		Dimensions Dimensões Dimensiones (mm)				Kg	Max ap (mm)			Insert Pastilha Inserto	Stock
			ϕDc	ϕM	ϕdg	L		LP/MP	HF	MH		
181088200	016R20190-02-05-M08025		16	M8	14	25	0,03	10,0	0,80	3,00	XP... 1003...	
181088300	020R20190-03-05-M10030		20	M10	18	30	0,06	10,0	0,80	3,00	XP... 1003...	
181088400	025R20190-04-05-M12035		25	M12	21	35	0,12	10,0	0,80	3,00	XP... 1003...	
181088500	032R20190-05-06-M16035		32	M16	29	35	0,15	10,0	0,80	3,00	XP... 1003...	
181149100	040R20190-06-08-M16043		40	M16	29	43	0,25	10,0	0,80	3,00	XP... 1003...	

Stock item | Produto de stock | Itens de stock

Available under request (see page A-8) | Disponível sobre consulta (consulte a página A-8) | Disponible bajo consulta (mire pagina A-8)



Weldon Shank

$K_r=90^\circ$ | $\gamma_p=+5^\circ\sim 8^\circ$

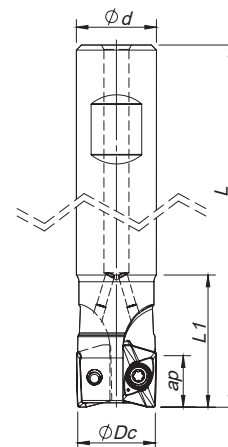

Order code Código	Reference Referência Referencia		Dimensions Dimensões Dimensiones (mm)				Kg	Max ap (mm)			Insert Pastilha Inserto	Stock
			ØDc	Ød	L	L1		LP/MP	HF	MH		
181087900	016W20190-02-05-016085	2	16	16	85	32	0,10	10,0	0,80	3,00	XP... 1003...	
181100600	016W20190-02-05-016150	2	16	16	150	70	0,13	10,0	0,80	3,00	XP... 1003...	
181108600	017W20190-02-05-016150	2	17	16	150	36	0,14	10,0	0,80	3,00	XP... 1003...	
181088000	020W20190-03-05-020090	3	20	20	90	28	0,21	10,0	0,80	3,00	XP... 1003...	
181100700	020W20190-03-05-020150	3	20	20	150	70	0,26	10,0	0,80	3,00	XP... 1003...	
181108700	022W20190-03-05-020150	3	22	20	150	70	0,30	10,0	0,80	3,00	XP... 1003...	
181088100	025W20190-04-05-025095	4	25	25	95	30	0,33	10,0	0,80	3,00	XP... 1003...	
181100800	025W20190-04-05-025150	4	25	25	150	80	0,36	10,0	0,80	3,00	XP... 1003...	
181108800	027W20190-04-05-025150	4	27	25	150	80	0,38	10,0	0,80	3,00	XP... 1003...	
181085400	032W20190-04-08-032110	4	32	32	110	50	0,55	10,0	0,80	3,00	XP... 1003...	

Stock item | Produto de stock | Itens de stock

Available under request (see page A-8) | Disponível sobre consulta (consulte a página A-8) | Disponible bajo consulta (mire pagina A-8)



Cylindrical Shank

$K_r=90^\circ$ | $\gamma_p=+4^\circ$

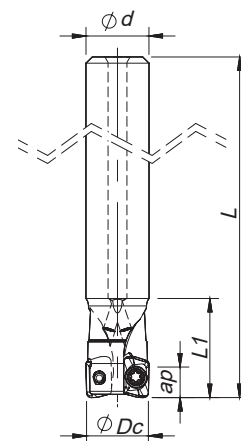

Order code Código	Reference Referência Referencia		Dimensions Dimensões Dimensiones (mm)				Kg	Max ap (mm)			Insert Pastilha Inserto	Stock
			ØDc	Ød	L	L1		LP/MP	HF	MH		
181171700	016E20190-02-05-016085	2	16	16	85	32	0,10	10,0	0,8	3,0	XP...1003...	
181173000	016E20190-02-05-016150	2	16	16	150	70	0,13	10,0	0,8	3,0	XP...1003...	
181171600	020E20190-03-05-020090	3	20	20	90	28	0,21	10,0	0,8	3,0	XP...1003...	
181171800	020E20190-03-05-020150	3	20	20	150	70	0,26	10,0	0,8	3,0	XP...1003...	
181171400	025E20190-04-05-025095	4	25	25	95	30	0,33	10,0	0,8	3,0	XP...1003...	
181172900	025E20190-04-05-025150	4	25	25	150	80	0,36	10,0	0,8	3,0	XP...1003...	

Stock item | Produto de stock | Itens de stock

Available under request (see page A-8) | Disponível sobre consulta (consulte a página A-8) | Disponible bajo consulta (mire pagina A-8)

LINEPRO 20190

XP... 1003... | Inserts | Pastilhas | Plaquetas

A

MILLING

Overview

Face milling

Hifeed milling

Shoulder milling

Profile milling

Hardmill

Center & Chamfer

Spot face

Spare Parts

Technical Data

End Mills

XPET-LP
(PHH-PHP grade)

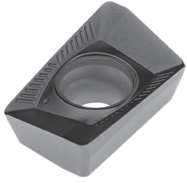

XPET-MP
(PHH-PHP grade)

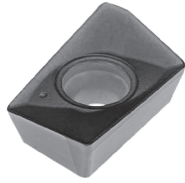

XPET-LN

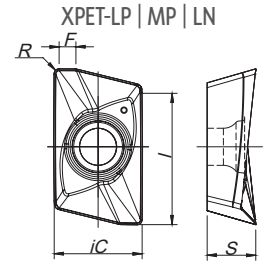

XPET-HF
(HiFeed geometry)



XPHW-MH
(finishing geometry)

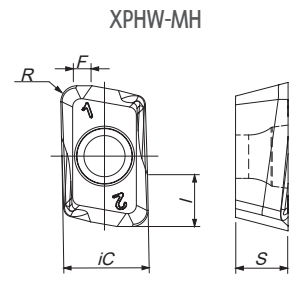
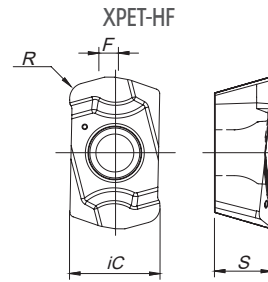
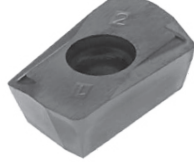

XPHW-R Z1 **NEW**

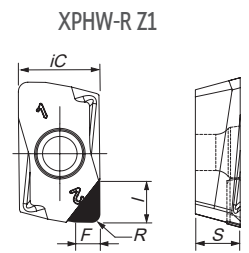
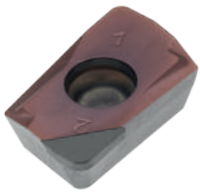

		P		M	K			N	S	H		Dimensions Dimensões Dimensiones (mm)										
		CVD	PVD			PVD	CVD	PVD		UNC	PCD						PVD	PVD				
(1)	(2) Grade code	T9	G1	X5	T1	P4	X9	L5	L9	X5	T1	P4	10	D6	X9	X4	X6	iC	S	I	R	F
Geometry code	ISO Reference	PHS740	PH7910	PHP910	PHP920	PHP930	PHH930	PH5705	PH5740	PHP910	PHP920	PHP930	PH0910	PDP410	PHH930	PHH603	PHH910					
1111980	XPET 100304 PDER-LP				⊗	⊗	⊗				⊗	⊗			⊗			6,95	3,96	10,50	0,40	1,30
1111981	XPET 100308 PDER-LP	⊗			⊗	⊗	⊗				⊗	⊗			⊗			6,95	3,96	10,50	0,80	1,40
1112022	XPET 100316 PDER-LP				⊗	⊗	⊗				⊗	⊗			⊗			6,95	3,96	10,50	1,60	0,80
1111982	XPET 100304 PDSR-MP		⊗		⊗	⊗		⊗	⊗		⊗	⊗						6,95	3,96	10,50	0,40	1,10
1111983	XPET 100308 PDSR-MP	⊗	⊗		⊗	⊗		⊗	⊗		⊗	⊗						6,95	3,96	10,50	0,80	1,35
1111984	XPET 100304 PDFR-LN												⊗					6,95	3,96	10,50	0,40	0,75
1112906	XPET 100308 PDFR-LN												⊗					6,95	3,96	10,50	0,80	1,05
1111985	XPET 100312 PDFR-LN												⊗					6,95	3,96	10,50	1,20	0,75
1112376	XPET 100312 ZDR-HF			⊗	⊗	⊗	⊗			⊗	⊗	⊗			⊗			6,95	3,96	-	1,20	1,50
1112500	XPHW 100308 ZER-MH															⊗	⊗	6,95	3,60	3,00	0,80	1,30
1112736	XPHW 100310 ZER-MH															⊗		6,95	3,60	3,00	1,00	0,35
1112735	XPHW 100320 ZER-MH															⊗		6,95	3,60	3,00	1,20	1,10
1112556	XPHW 100308 R Z1													⊗				6,95	3,60	3,80	0,80	2,30

⊗ First choice | Primeira opção | 1ª opción ⊗ Stock item | Produto de stock | Itens de stock ○ Available under request (see page A-9) | Disponível sobre consulta (consulte a página A-9) | Disponible bajo consulta (mire página A-9) Insert order code = (1) Geometry Code + (2) Grade Code

SPARE PARTS | Complementos | Repuestos

Cutter ØDc	Insert Screw	Key (Torx)	Order separately	
			Key (Torx - Nm)	Torque Value
W20190 - 16-17	P0250503	XT08	DT0812	1,2
W20190 - 20-32	P0250704	XT08	DT0812	1,2
R20190 - 16	P0250503	XT08	DT0812	1,2
R20190 - 20-40	P0250704	XT08	DT0812	1,2
A20190 - 40-63	P0250704	XT08	DT0812	1,2

Note: The toolholder is supplied with the XT/PT key. To order the DT key please check the page A-241.
Check the procedures for the clamping screws on the page A-241.

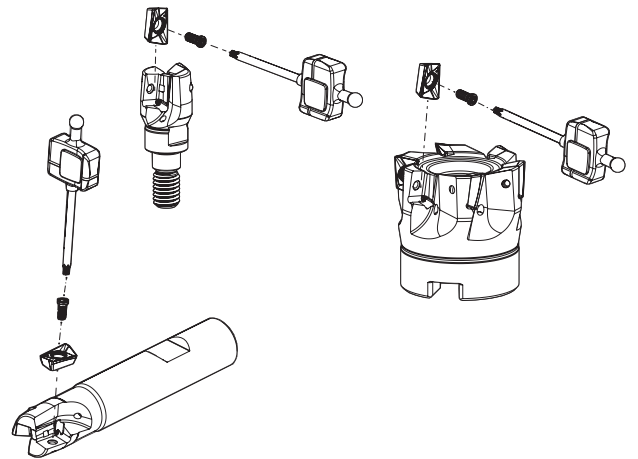

PROGRAMMING DATA | Dados para programação | Datos para la programación

Insert	Programming Data		
	Rp	X	b
XPET 10 HF	1,6	0,33	3,45

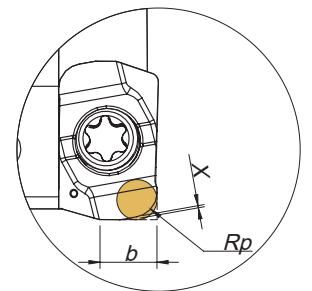

RAMPING AND HELICAL INTERPOLATION

Descida em rampa e interpolação helicoidal | Bajada en rampa e interpolación circular

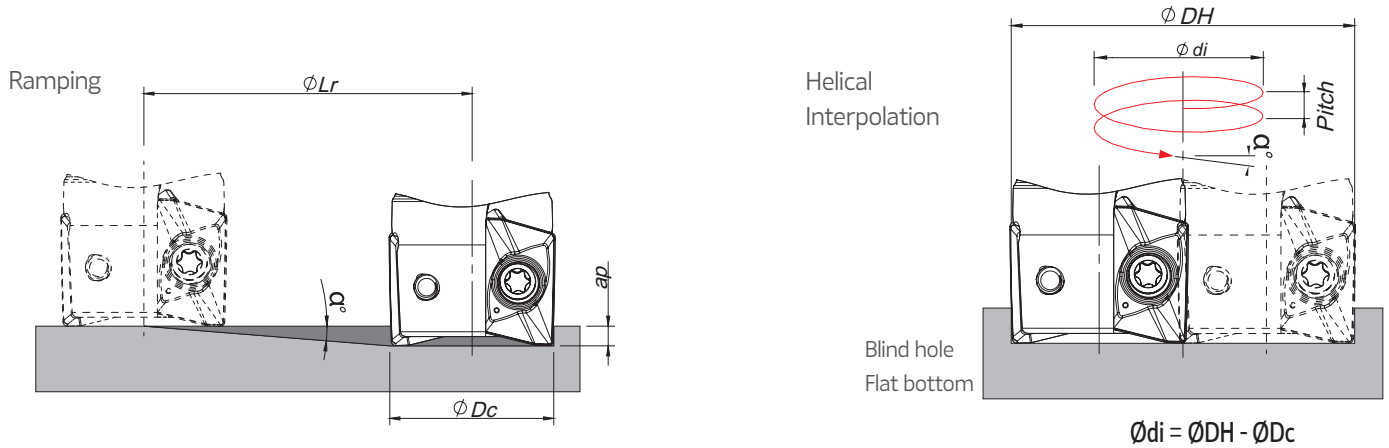

ϕDc	Ramping			Helical Interpolation		
	Max Ramp a°	Max a_p	Min Lr	Diameter for Blind Hole, Flat Bottom Face (1)		Max Pitch/Rev.
				ϕDH_{min}	ϕDH_{max}	
16	7,5	10,0	76,0	27,6 -	- 30,4	4,8 6,0
17	7,0	10,0	81,4	29,6 -	- 32,4	4,9 5,9
20	5,0	10,0	114,3	35,6 -	- 38,4	4,3 5,1
22	4,5	10,0	127,1	39,6 -	- 42,4	4,3 5,0
25	3,5	10,0	163,5	45,6 -	- 48,4	4,0 4,5
27	3,0	10,0	190,8	49,6 -	- 52,4	3,7 4,2
32	2,5	10,0	229,0	59,6 -	- 62,4	3,8 4,2
40	1,7	10,0	336,9	75,6 -	- 78,4	3,3 3,6
50	1,3	10,0	440,7	95,6 -	- 98,4	3,2 3,4
63	1,0	10,0	572,9	121,6 -	- 124,4	3,2 3,4

(1) using LP insert with radius 0,8 mm

Note: During helical interpolation do not exceed maximum pitch

When using HF insert or other different insert radius to calculate the ϕDH_{min} and ϕDH_{max} use the equation below:

- Minimum Diameter: $\phi DH_{min} = 2 \times (\phi Dc - (R \text{ corner radius} + F \text{ width of edge wiper}))$

- Maximum Diameter: $\phi DH_{max} = 2 \times (\phi Dc - R \text{ corner radius})$

CHIP-BREAKER SELECTION GUIDE | Guia para aplicações do quebra- aparas | Guía para aplicación del rompevirutas

ISO	PSM	Material	HB (Brinell)	Chip-Breaker Application	
				1st choice	Difficult Operations
P	1	Unalloyed Steel	125-220	XPET 10 ... LP/HF	XPET 10 ... MP
	2	Low-Alloyed Steel	220-280	XPET 10 ... LP/HF	XPET 10 ... MP
	3	High-Alloyed Steel	280-380	XPET 10 ... MP/HF	-
M	4	SS - Ferritic / Martensitic	200-330	XPET 10 ... LP/HF	-
	5	SS - Austenitic	200-330	XPET 10 ... LP/HF	-
	6	SS - Austenitic-ferritic (Duplex)	230-260	XPET 10 ... LP/HF	-
K	7	Malleable Cast Iron	130-230	XPET 10 ... LP/HF	XPET 10 ... MP
	8	Grey Cast Iron	180-245	XPET 10 ... MP/HF	-
	9	Nodular Cast iron	160-250	XPET 10 ... MP/HF	-
N	10	Aluminium and Non Ferrous	30-130	XPET 10 ... LN	-
S	11	Heat Resistant Super Alloys	200-320	XPET 10 ... LP/HF	-
H	12	Hardened Steels	40-55 HRC	XPHW 10 ... MH	-

GRADES SELECTION GUIDE | Guia para selecção de graus | Tabla para selección de calidades

ISO	PSM	Material	HB (Brinell)	Grades								
				← Wear Resistance				Toughness →				
				PH0910	PH5705	PHH603	PHP910	PHP920	PHP930	PHH930	PH5740	PHS740
P	1	Unalloyed Steel	125-220	●	●	●	●	●	●	●	●	●
	2	Low-Alloyed Steel	220-280				●	●	●			●
	3	High-Alloyed Steel	280-380			●	●	●	●			●
M	4	SS - Ferritic / Martensitic	200-330							●		
	5	SS - Austenitic	200-330							●		
	6	SS - Austenitic-ferritic (Duplex)	230-260							●		
K	7	Malleable Cast Iron	130-230		●		●	●	●		●	
	8	Grey Cast Iron	180-245		●		●	●	●		●	
	9	Nodular Cast iron	160-250		●		●	●	●		●	
N	10	Aluminium and Non Ferrous	30-130	●								
S	11	Heat Resistant Super Alloys	200-320							●		
H	12	Hardened Steels	40-55 HRC			●						

● Good Conditions

● Average Conditions

● Difficult Conditions

RECOMMENDED CUTTING CONDITIONS | Condições de corte recomendadas | Condiciones de corte recomendables

ISO	PSM	Material	HB (Brinell)	Vc (m/min)								
				← Wear Resistance						Toughness →		
				PH0910	PH5705	PHH603	PHP910	PHP920	PHP930	PHH930	PH5740	PHS740
P	1	Unalloyed Steel	125-220	-	-	-	180-250	180-250	160-230	-	-	140-220
	2	Low-Alloyed Steel	220-280	-	-	-	160-240	160-230	140-210	-	-	120-200
	3	High-Alloyed Steel	280-380	-	-	180-310	140-230	140-220	120-200	-	-	100-190
M	4	SS - Ferritic / Martensitic	200-330	-	-	-	-	-	-	140-210	-	-
	5	SS - Austenitic	200-330	-	-	-	-	-	-	120-170	-	-
	6	SS - Austenitic-ferritic (Duplex)	230-260	-	-	-	-	-	-	100-150	-	-
K	7	Malleable Cast Iron	130-230	-	160-290	-	180-300	160-270	150-250	-	160-260	-
	8	Grey Cast Iron	180-245	-	170-320	-	160-250	140-250	140-230	-	140-240	-
	9	Nodular Cast iron	160-250	-	140-200	-	150-210	120-210	100-200	-	120-200	-
N	10	Aluminium and Non Ferrous	30-130	100-2000	-	-	-	-	-	-	-	-
S	11	Heat Resistant Super Alloys	200-320	-	-	-	-	-	-	30-110	-	-
H	12	Hardened Steels	40-55 HRC	-	-	70-270	-	-	-	-	-	-

(Note 1): Cutting conditions $a_e/D_c=70\%$.

(Note 2): PH5... and PHS... can be used wet or dry. PH7... use only air.

(Note 3):

Operation	a_e	Vc & fz	a_p (mm)
Slotting	100%	<20%	2,0-4,0
Shouldering	<50%	>8%	3,0-6,0
	≤25%	>12%	7,0-9,0

(Note 4):

It's possible to occur vibrations in certain cases. Please reduce depth of cut and / or reduce cutting conditions in following cases:

- When using long shank;
- When using long tool overhang with arbor type;
- When application has poor clamping rigidity or when using a low rigidity machine.

Feed fz (mm/t)				
XPET 10... LP	XPET 10... MP	XPET 10... LN	XPET 10... HF	XPHW 10... MH
0,08-0,20	0,10-0,25	-	0,40-0,80	0,10-0,25
0,08-0,20	0,10-0,20	-	0,40-0,80	0,10-0,25
0,08-0,15	0,10-0,20	-	0,40-0,60	0,10-0,25
0,08-0,20	0,10-0,20	-	0,40-0,70	-
0,08-0,20	0,10-0,20	-	0,40-0,70	-
0,08-0,15	0,10-0,20	-	0,40-0,60	-
0,08-0,20	0,10-0,25	-	0,50-0,80	-
0,08-0,20	0,10-0,25	-	0,50-0,80	-
0,08-0,20	0,10-0,20	-	0,50-0,60	-
-	-	0,07-0,25	-	-
0,05-0,07	-	-	0,40-0,60	-
-	-	-	-	0,08-0,15

A

MILLING

Overview

Face milling

Hifeed milling

Shoulder milling

Profile milling

Hardmill

Center & Chamfer

Spot face

Spare Parts

Technical Data

End Mills

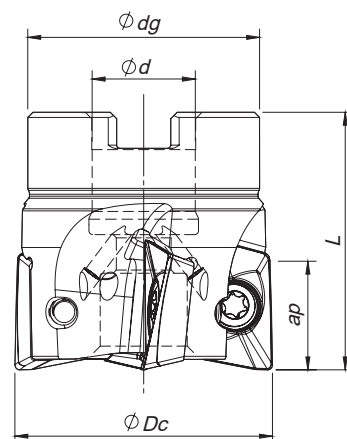
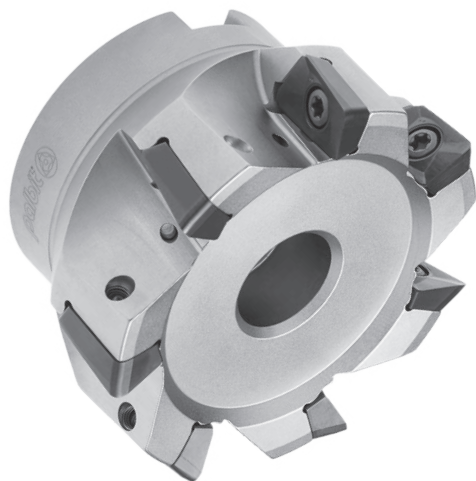

Arbor Mounting

$K_r=90^\circ$ | $\gamma_p=+7^\circ \sim +8^\circ$

Order code Código	Reference Referência Referencia		Dimensions Dimensões Dimensiones (mm)				Kg	Specifications		Insert Pastilha Inserto	Stock
			ϕDc	ϕd	ϕdg	L		Arbor Type	Ap max (mm)		
181090900	040A20290-04-07-016040	4	40	16	32	40	0,18	A	17,0	XPET 1706...	
181091000	050A20290-05-08-022040	5	50	22	42	40	0,29	A	17,0	XPET 1706...	
181091100	063A20290-06-08-027040*	6	63	27	52	40	0,53	A	17,0	XPET 1706...	
181091200	080A20290-07-08-027050	7	80	27	60	50	0,92	A	17,0	XPET 1706...	
181091300	100A20290-08-08-032050	8	100	32	80	50	1,68	A	17,0	XPET 1706...	
181091400	125A20290-09-08-040063	9	125	40	90	63	3,01	A	17,0	XPET 1706...	

Stock item | Produto de stock | Itens de stock

Available under request (see page A-8) | Disponível sobre consulta (consulte a página A-8) | Disponible bajo consulta (mire pagina A-8)

* For shank assembly a DIN 6920 screw is needed.

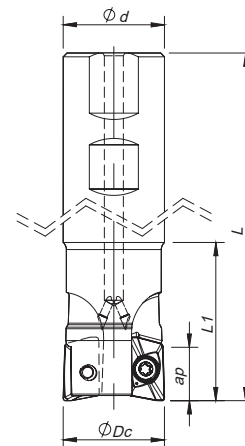

Weldon Shank

$K_r=90^\circ$ | $\gamma_p=+6^\circ \sim +7^\circ$

Order code Código	Reference Referência Referencia		Dimensions Dimensões Dimensiones (mm)				Kg	Specifications		Insert Pastilha Inserto	Stock
			ϕDc	ϕd	L	L1		Ap max (mm)			
181090500	032W20290-02-06-032110	2	32	32	110	50	0,56	17,0	XPET 1706...		
181090600	032W20290-02-06-032200	2	32	32	200	60	1,10	17,0	XPET 1706...		
181090700	040W20290-03-07-032115	3	40	32	115	50	0,67	17,0	XPET 1706...		
181090800	040W20290-03-07-032200	3	40	32	200	60	1,19	17,0	XPET 1706...		

Stock item | Produto de stock | Itens de stock

Available under request (see page A-8) | Disponível sobre consulta (consulte a página A-8) | Disponible bajo consulta (mire pagina A-8)

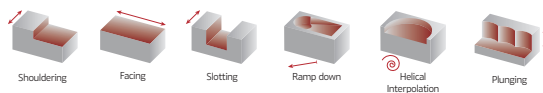

XPET 1706... | Inserts | Pastilhas | Plaquetas

XPET-LP

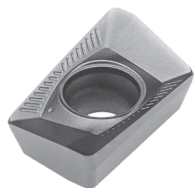

XPET-MP



XPET-LN



XPET-LP | MP | LN | LS

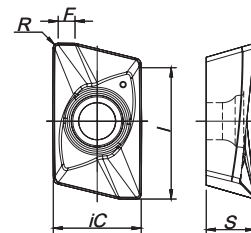

XPET-LS (PHH grade) **NEW**



(1) Geometry code	(2) Grade code	P		M		K				N		S		Dimensions Dimensões Dimensiones (mm)					
		CVD	PVD			PVD		CVD		PVD		UNC	PVD		iC	S	I	R	F
		T9	T1	G6	X9	G6	L5	L9	T1	G6	10	X9	G6						
1111986	XPET 170608 PDER-LP		⊗	⊗		⊗			⊗	⊗			⊗	11,30	6,35	17,50	0,80	1,80	
1111987	XPET 170616 PDER-LP		⊗	⊗		⊗			⊗	⊗			⊗	11,30	6,35	17,50	1,60	1,20	
1111988	XPET 170608 PDSR-MP	⊗	⊗	⊗			⊗	⊗	⊗	⊗				11,30	6,35	17,50	0,80	1,80	
1111989	XPET 170616 PDSR-MP		⊗	⊗			⊗	⊗	⊗	⊗				11,30	6,35	17,50	1,60	1,00	
1111990	XPET 170608 PDFR-LN										⊗			11,30	6,35	17,50	0,80	1,20	
1111991	XPET 170620 PDFR-LN										⊗			11,30	6,35	17,50	2,00	1,00	
1111992	XPET 170632 PDFR-LN										⊗			11,30	6,35	17,50	3,20	0,80	
NEW 1112223	XPET 170608 PDER-LS				⊗	⊗						⊗	⊗	11,3	6,35	17,5	0,8	1,8	

⊗ First choice | Primeira opção | 1ª opción ⊗ Stock item | Produto de stock | Itens de stock ○ Available under request (see page A-9) | Disponível sobre consulta (consulte a página A-9) | Disponible bajo consulta (mire página A-9) Insert order code = (1) Geometry Code + (2) Grade Code

SPARE PARTS | Complementos | Repuestos

Cutter ØDc	Order separately				
	Insert Screw	Key (Torx)	Key (Torx - Nm)	Torque Value	Retaining Screw
W20290 - 32-40	P0451001	XT20	DT2050	5	-
A20290 - 40-80	P0451001	XT20	DT2050	5	-
A20290 - 100	P0451001	PT20	DT2050	5	D1603500
A20290 - 125	P0451001	PT20	DT2050	5	D2004000

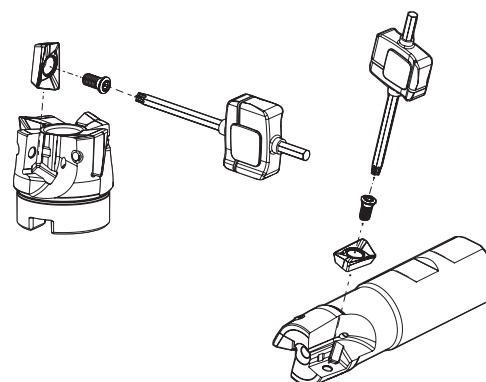

Note: The toolholder is supplied with the XT/PT key. To order the DT key please check the page A-241.
Check the procedures for the clamping screws on the page A-241.

LINEPRO 20290

A

GRADES SELECTION GUIDE | Guia para selecção de graus | Tabla para selección de calidades

MILLING

Overview

Face milling

Hifeed milling

Shoulder milling

Profile milling

Hardmill

Center & Chamfer

Spot face

Spare Parts

Technical Data

End Mills

ISO	PSM	Material	HB (Brinell)	Grades							
				← Wear Resistance				Toughness →			
				PH0910	PH5705	PHP920	PHP930	PHH930	PH5740	PHS740	PH7740
P	1	Unalloyed Steel	125-220	●	●	●	●	●	●	●	●
	2	Low-Alloyed Steel	220-280			●	●			●	●
	3	High-Alloyed Steel	280-380			●	●			●	●
M	4	SS - Ferritic / Martensitic	200-330					●			●
	5	SS - Austenitic	200-330					●			●
	6	SS - Austenitic-ferritic (Duplex)	230-260					●			●
K	7	Malleable Cast Iron	130-230		●	●	●		●		●
	8	Grey Cast Iron	180-245		●	●	●		●		●
	9	Nodular Cast iron	160-250		●	●	●		●		●
N	10	Aluminium and Non Ferrous	30-130	●							
S	11	Heat Resistant Super Alloys	200-320					●			●

● Good Conditions

● Average Conditions

● Difficult Conditions

CHIP-BREAKER SELECTION GUIDE | Guia para aplicações do quebra- aparas | Guía para aplicación del rompevirutas

ISO	PSM	Material	HB (Brinell)	Chip-Breaker Application	
				1st choice	Difficult Operations
				P	1
2	Low-Alloyed Steel	220-280	XPET 17... LP		XPET 17... MP
3	High-Alloyed Steel	280-380	XPET 17... MP		-
M	4	SS - Ferritic / Martensitic	200-330	XPET 17... LS	XPET 17... LP
	5	SS - Austenitic	200-330	XPET 17... LS	XPET 17... LP
	6	SS - Austenitic-ferritic (Duplex)	230-260	XPET 17... LS	XPET 17... LP
K	7	Malleable Cast Iron	130-230	XPET 17... LP	XPET 17... MP
	8	Grey Cast Iron	180-245	XPET 17... MP	-
	9	Nodular Cast iron	160-250	XPET 17... MP	-
N	10	Aluminium and Non Ferrous	30-130	XPET 17... LN	-
S	11	Heat Resistant Super Alloys	200-320	XPET 17... LS	XPET 17... LP

RECOMMENDED CUTTING CONDITIONS | Condições de corte recomendadas | Condiciones de corte recomendables

ISO	PSM	Material	HB (Brinell)	Vc (m/min)				
				← Wear Resistance				
				PH0910	PH5705	PHP920	PHP930	PHH930
P	1	Unalloyed Steel	125-220	-	-	180-250	160-230	-
	2	Low-Alloyed Steel	220-280	-	-	160-230	140-210	-
	3	High-Alloyed Steel	280-380	-	-	140-220	120-200	-
M	4	SS - Ferritic / Martensitic	200-330	-	-	-	-	140-210
	5	SS - Austenitic	200-330	-	-	-	-	120-170
	6	SS - Austenitic-ferritic (Duplex)	230-260	-	-	-	-	100-150
K	7	Malleable Cast Iron	130-230	-	160-290	160-270	-	-
	8	Grey Cast Iron	180-245	-	170-320	140-250	-	-
	9	Nodular Cast iron	160-250	-	140-200	120-210	-	-
N	10	Aluminium and Non Ferrous	30-130	100-2000	-	-	-	-
S	11	Heat Resistant Super Alloys	200-320	-	-	-	-	30-110

(Note 1) Cutting conditions ae/DC=70%

(Note 2) Cutting conditions should be adjusted according to the machine and work rigidity.

(Note 3):

Operation	ae	Vc & fz	ap (mm)
Slotting	100%	<20%	2,0-6,0
Shouldering	<50%	>8%	7,0-13,0
	≤25%	>12%	13,0-16,0

(Note 4) It's possible to occur vibrations in certain cases.

Please reduce depth of cut and / or reduce cutting conditions in following cases:

- When using long shank;
- When using long tool overhang with arbor type;
- When application has poor clamping rigidity or when using a low rigidity machine.

RAMPING AND HELICAL INTERPOLATION

Descida em rampa e interpolação helicoidal | Bajada en rampa e interpolación circular

Ramping

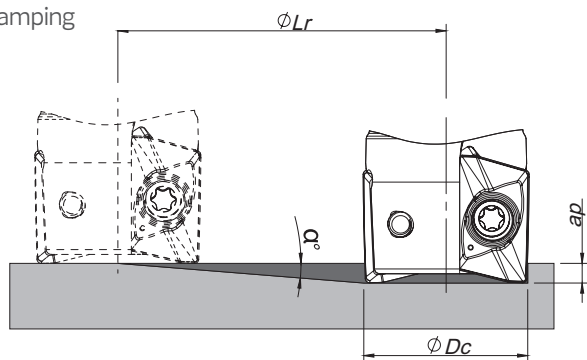

Helical Interpolation

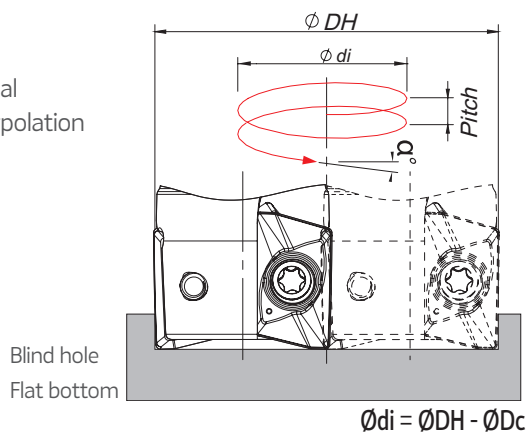

ØDc	Ramping			Helical Interpolation		
	Max Ramp α°	Max ap	Min Lr	Diameter for Blind Hole, Flat Bottom Face (1)		Max Pitch/Rev.
				ØDHmin	ØDHmax	
32	3,8	17,0	255,9	58,8 -	- 62,4	5,6 6,3
40	2,7	17,0	360,5	74,8 -	- 78,4	5,2 5,7
50	2,0	17,0	486,8	94,8 -	- 98,4	4,9 5,3
63	1,5	17,0	649,2	120,8 -	- 124,4	4,8 5,0
80	1,0	17,0	973,9	154,8 -	- 158,4	4,1 4,3
100	0,8	17,0	1217,5	194,8 -	- 198,4	4,2 4,3
125	0,7	17,0	1498,4	244,8 -	- 248,4	4,3 4,4

(1) using LP insert with radius 0,8 mm

Note: During helical interpolation do not exceed maximum pitch

When using HF insert or other different insert radius to calculate the ØDHmin and ØDHmax use the equation below:

- Minimum Diameter: $\text{ØDHmin} = 2 \times (\text{ØDc} - (\text{R corner radius} + \text{F width of edge wiper}))$

- Maximum Diameter: $\text{ØDHmax} = 2 \times (\text{ØDc} - \text{R corner radius})$

Vc (m/min)			Feed fz (mm/t)			
			Toughness →			
PH5740	PHS740	PH7740	XPET 17... LP	XPET 17... MP	XPET 17... LN	XPET 17... LS
-	140-220	140-200	0,10-0,35	0,10-0,35	-	-
-	120-200	130-180	0,10-0,35	0,10-0,35	-	-
-	100-190	100-170	0,10-0,30	0,10-0,30	-	-
-	-	130-180	0,10-0,30	-	-	0,10-0,35
-	-	110-160	0,10-0,30	-	-	0,10-0,30
-	-	90-150	0,10-0,25	-	-	0,10-0,25
160-260	-	140-220	0,10-0,35	0,10-0,35	-	-
140-240	-	120-210	0,10-0,35	0,10-0,35	-	-
120-200	-	100-190	0,10-0,30	0,10-0,30	-	-
-	-	-	-	-	0,10-0,35	-
-	-	30-100	0,10-0,20	-	-	0,10-0,20

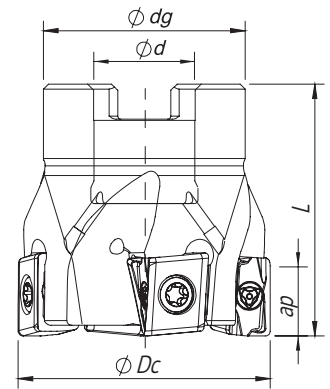

Arbor Mounting
 $K_r=90^\circ$ | $\gamma_p=-4^\circ$

Order code Código	Reference Referência Referencia		Dimensions Dimensões Dimensiones (mm)				Kg	Specifications		Insert	Stock
			ϕDc	ϕd	ϕDg	L		Ap max (mm)	Arbor Type		
181144400	040A90090-04-04-016040	4	40	16	36	40	0,24	7,0	A	LNXT 0904...	
181144500	050A90090-05-04-022040	5	50	22	40	40	0,32	7,0	A	LNXT 0904...	
181144600	063A90090-07-04-022040	7	63	22	48	40	0,54	7,0	A	LNXT 0904...	
181146600	063A90090-10-04-022040	10	63	22	48	40	0,54	7,0	A	LNXT 0904...	

Stock item | Produto de stock | Itens de stock

Available under request (see page A-8) | Disponível sobre consulta (consulte a página A-8) | Disponible bajo consulta (mire pagina A-8)

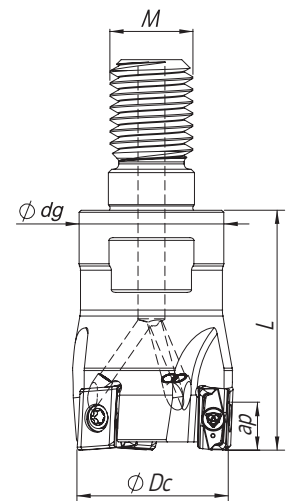

Threaded Coupling
 $K_r=90^\circ$ | $\gamma_p=-4^\circ$

Order code Código	Reference Referência Referencia		Dimensions Dimensões Dimensiones (mm)				Kg	Specifications		Insert	Stock
			ϕDc	ϕM	ϕdg	L		Ap max (mm)	Arbor Type		
181144200	025R90090-03-04-M12035	3	25	12	21	35	0,10	7,0	LNXT 0904...		
181144300	032R90090-04-04-M16040	4	32	16	29	40	0,21	7,0	LNXT 0904...		

Stock item | Produto de stock | Itens de stock

Available under request (see page A-8) | Disponível sobre consulta (consulte a página A-8) | Disponible bajo consulta (mire pagina A-8)

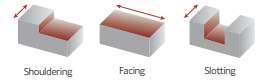

Weldon Shank
 $K_r = 90^\circ$ | $\gamma_p = -4^\circ \sim -6^\circ$

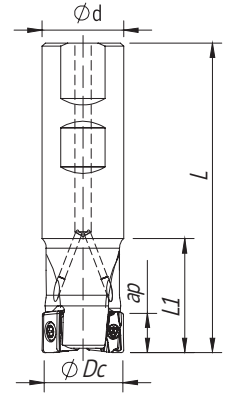

Order code Código	Reference Referência Referencia		Dimensions Dimensões Dimensiones (mm)				Kg	Specifications	Insert	Stock
			$\varnothing D_c$	$\varnothing d$	L	L1		A_p max (mm)		
181109400	016W90090-02-06-016090	2	16	16	90	25	0,12	7,0	LNXT 0904...	
181109500	025W90090-03-04-025095	3	25	25	95	30	0,31	7,0	LNXT 0904...	
181144100	032W90090-04-04-032110	4	32	32	110	30	0,61	7,0	LNXT 0904...	

Stock item | Produto de stock | Itens de stock

Available under request (see page A-8) | Disponível sobre consulta (consulte a página A-8) | Disponible bajo consulta (mire pagina A-8)



Cylindrical Shank
 $K_r = 90^\circ$ | $\gamma_p = -4^\circ$

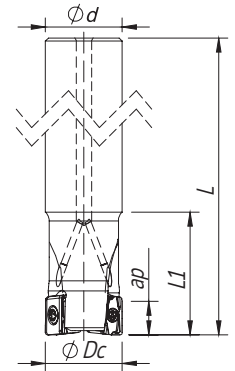

Order code Código	Reference Referência Referencia		Dimensions Dimensões Dimensiones (mm)				Kg	Specifications	Insert	Stock
			$\varnothing D_c$	$\varnothing d$	L	L1		A_p max (mm)		
NEW 181158800	020E90090-02-04-020150	2	20	20	150	30	0,15	7,0	LNXT 0904...	
181148100	025E90090-03-04-025200	3	25	25	200	30	0,31	7,0	LNXT 0904...	
181148200	032E90090-04-04-032250	4	32	32	250	30	0,78	7,0	LNXT 0904...	

Stock item | Produto de stock | Itens de stock

Available under request (see page A-8) | Disponível sobre consulta (consulte a página A-8) | Disponible bajo consulta (mire pagina A-8)

SPARE PARTS | Complementos | Repuestos

Cutter ØDc	Insert Screw	Key (Torx)	Order separately	
			Key (Torx - Nm)	Torque Value
E90090 - 25-32	P0250700	XT07	DT0709	1,2
W90090 - 16-32	P0250700	XT07	DT0709	1,2
A90090 - 40-63	P0250700	XT07	DT0709	1,2
R90090 - 25-32	P0250700	XT07	DT0709	1,2

Note: The toolholder is supplied with the XT/PT key. To order the DT key please check the page A-241. Check the procedures for the clamping screws on the page A-241.

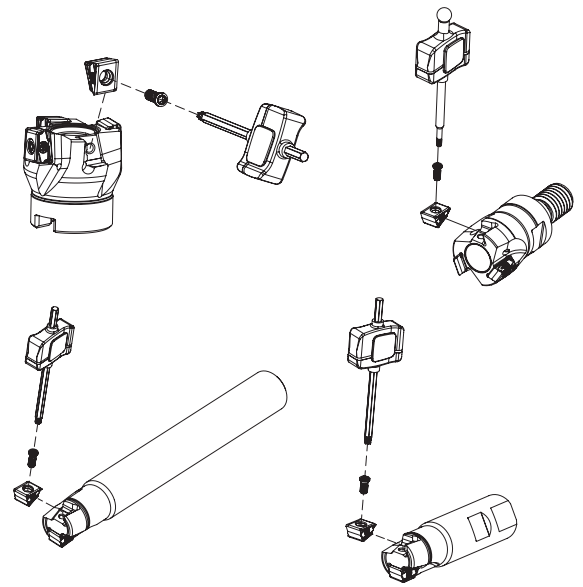

LNXT 0904... | Inserts | Pastilhas | Plaquetas

LNXT-MP

LNXT-LS
(PHH grade)

NEW



LNXT-MP | LS

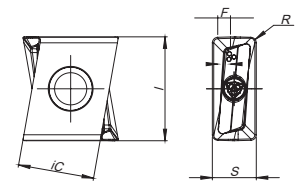

Geometry code	ISO Reference	P			M	K		S	Dimensions Dimensões Dimensiones (mm)					
		CVD	PVD		PVD	CVD	PVD	PVD	iC	S	I	R	F	
(1)	(2) Grade code	T9	T1	G6	X9	L6	T1	G6	X9					
1112225	LNXT 090404 PNER-MP	☺	☹	☺		☹	☹	☺		9,4	4,5	9,0	0,4	-
1112226	LNXT 090408 PNER-MP	☺	☹	☺		☹	☹	☺		9,4	4,5	9,0	0,8	-
NEW 1112868	LNXT 090404 PNER-LS				☹				☹	9,4	4,5	9,0	0,8	-

☺ First choice | Primeira opção | 1ª opción ☹ Stock item | Produto de stock | Itens de stock ○ Available under request (see page A-9) | Disponível sobre consulta (consulte a página A-9) | Disponible bajo consulta (mire pagina A-9) Insert order code = (1) Geometry Code + (2) Grade Code

GRADES SELECTION GUIDE | Guia para selecção de graus | Tabla para selección de calidades

ISO	PSM	Material	HB (Brinell)	Grades				
				← Wear Resistance			Toughness →	
				PH5320	PHP920	PHH930	PHS740	PH7740
P	1	Unalloyed Steel	125-220		✓		✓	✓
	2	Low-Alloyed Steel	220-280		✓		✓	✓
	3	High-Alloyed Steel	280-380		✓		✓	✓
M	4	SS - Ferritic / Martensitic	200-330			✓		
	5	SS - Austenitic	200-330			✓		
	6	SS - Austenitic-ferritic (Duplex)	230-260			✓		
K	7	Malleable Cast Iron	130-230	✓	✓			✓
	8	Grey Cast Iron	180-245	✓	✓			✓
	9	Nodular Cast iron	160-250	✓	✓			✓
S	11	Heat Resistant Super Alloys	200-320			✓		



Good Conditions



Average Conditions



Difficult Conditions

RECOMMENDED CUTTING CONDITIONS | Condições de corte recomendadas | Condiciones de corte recomendables

ISO	PSM	Material	HB (Brinell)	Vc (m/min)					Feed fz (mm/t)	
				← Wear Resistance			Toughness →		LNXT 09... MP	LNXT 09... LS
				PH5320	PHP920	PHH930	PHS740	PH7740		
P	1	Unalloyed Steel	125-220	-	180-250	-	140-220	140-200	0,08-0,25	-
	2	Low-Alloyed Steel	220-280	-	160-230	-	120-200	130-180	0,08-0,25	-
	3	High-Alloyed Steel	280-380	-	140-220	-	100-190	100-170	0,08-0,15	-
M	4	SS - Ferritic / Martensitic	200-330	-	-	140-210	-	-	0,08-0,25	0,08-0,25
	5	SS - Austenitic	200-330	-	-	120-170	-	-	0,08-0,20	0,08-0,20
	6	SS - Austenitic-ferritic (Duplex)	230-260	-	-	100-150	-	-	0,08-0,15	0,08-0,20
K	7	Malleable Cast Iron	130-230	150-280	160-270	-	-	140-220	0,08-0,30	-
	8	Grey Cast Iron	180-245	160-320	140-250	-	-	120-210	0,08-0,25	-
	9	Nodular Cast iron	160-250	100-190	120-210	-	-	100-190	0,08-0,20	-
S	11	Heat Resistant Super Alloys	200-320	-	-	30-110	-	-	-	-

(Note 1) Cutting conditions $a_e/D_c=70\%$.

(Note 2) It's possible to occur vibrations in certain cases. Please reduce depth of cut and / or reduce cutting conditions in following cases:

- When using long shank;
- When using long tool overhang with arbor type;
- When application has poor clamping rigidity or when using a low rigidity machine.

A

MILLING

Overview

Face milling

Hi-feed milling

Shoulder milling

Profile milling

Hardmill

Center & Chamfer

Spot face

Spare Parts

Technical Data

End Mills

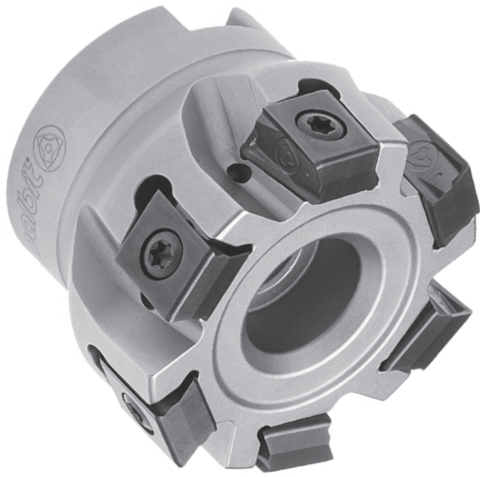

Arbor Mounting
 $K_r=90^\circ$ | $\gamma_p=-4^\circ$

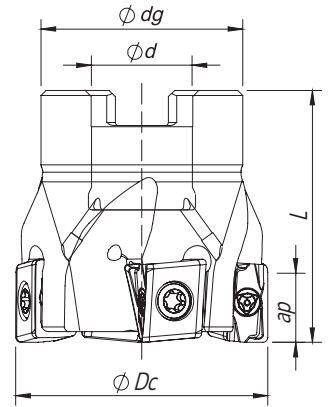

Order code Código	Reference Referência Referencia		Dimensions Dimensões Dimensiones (mm)				Kg	Specifications		Insert	Stock
			ϕDc	ϕd	ϕdg	L		Ap max (mm)	Arbor Type		
181118800	040A90190-04-04-016040	4	40	16	32	40	0,17	11	A	LNXT 1306...	
181118900	040A90190-05-04-016040	5	40	16	32	40	0,18	11	A	LNXT 1306...	
181111200	050A90190-05-04-022040	5	50	22	42	40	0,27	11	A	LNXT 1306...	
181111300	050A90190-06-04-022040	6	50	22	42	40	0,28	11	A	LNXT 1306...	
181119000	063A90190-06-04-022040	6	63	22	52	40	0,52	11	A	LNXT 1306...	
181119100	063A90190-08-04-022040	8	63	22	52	40	0,52	11	A	LNXT 1306...	
181119200	080A90190-07-04-027050	7	80	27	60	50	0,88	11	B	LNXT 1306...	
181119300	080A90190-10-04-027050	10	80	27	60	50	0,86	11	B	LNXT 1306...	
181119400	100A90190-09-04-032050	9	100	32	80	50	1,56	11	B	LNXT 1306...	
181119500	100A90190-13-04-032050	13	100	32	80	50	1,56	11	B	LNXT 1306...	
181119600	125A90190-11-04-040063	11	125	40	90	63	2,87	11	B	LNXT 1306...	
181119700	125A90190-16-04-040063	16	125	40	90	63	2,86	11	B	LNXT 1306...	

Stock item | Produto de stock | Itens de stock

Available under request (see page A-8) | Disponível sobre consulta (consulte a página A-8) | Disponible bajo consulta (mire página A-8)



Weldon Shank
 $K_r=90^\circ$ | $\gamma_p=-4^\circ$

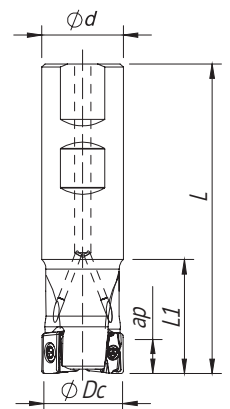

Order code Código	Reference Referência Referencia		Dimensions Dimensões Dimensiones (mm)				Kg	Specifications	Insert	Stock
			ϕDc	ϕd	L	L1		Ap max (mm)		
181118300	025W90190-02-04-025095	2	25	25	95	45	0,29	11	LNXT 1306...	
181109800	032W90190-03-04-032110	3	32	32	110	50	0,55	11	LNXT 1306...	
181118400	040W90190-04-04-032110	4	40	32	110	50	0,60	11	LNXT 1306...	

Stock item | Produto de stock | Itens de stock

Available under request (see page A-8) | Disponível sobre consulta (consulte a página A-8) | Disponible bajo consulta (mire página A-8)



Cylindrical Shank
 $K_r = 90^\circ$ | $\gamma_p = -4^\circ$

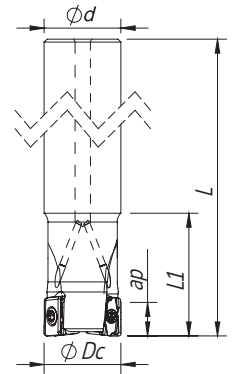

Order code Código	Reference Referência Referencia		Dimensions Dimensões Dimensiones (mm)				Kg	Specifications	Insert	Stock
			ϕD_c	ϕd	L	L ₁		A _p max (mm)		
181118500	025E90190-02-04-025200	2	25	25	200	40	0,66	11	LNXT 1306...	
181118600	032E90190-03-04-032250	3	32	32	250	50	1,37	11	LNXT 1306...	
181118700	040E90190-04-04-032250	4	40	32	250	50	1,42	11	LNXT 1306...	

Stock item | Produto de stock | Itens de stock

Available under request (see page A-8) | Disponível sobre consulta (consulte a página A-8) | Disponible bajo consulta (mire pagina A-8)

LNXT 1306... | Inserts | Pastilhas | Plaquitas

LNXT-MP



LNXT-MP

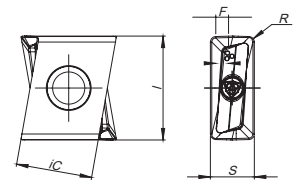

Geometry code	ISO Reference	P			M	K			Dimensions Dimensões Dimensiones (mm)				
		CVD	PVD		PVD	CVD	PVD						
		T9	T1	G6	G6	L6	T1	G6	iC	S	I	R	F
1112242	LNXT 130604 PNER-MP								9,8	6,8	13,0	0,4	0,9
1112243	LNXT 130608 PNER-MP								9,8	6,8	13,0	0,8	0,9

First choice | Primeira opção | 1ª opción

Stock item | Produto de stock | Itens de stock

Available under request (see page A-9) | Disponível sobre consulta (consulte a página A-9) | Disponible bajo consulta (mire pagina A-9)

Insert order code = (1) Geometry Code + (2) Grade Code

TGPLUS 90190

SPARE PARTS | Complementos | Repuestos

Cutter ØDc	Insert Screw	Key (Torx)	Order separately		Order separately	
			Key (Torx - Nm)	Torque Value	Screw	DIN 6368 Wrench
E90190 - 25	P0400900	XT15	DT1530	3,0	-	-
E90190 - 32-40	P0401200	XT15	DT1530	3,0	-	-
W90190 - 25	P0400900	XT15	DT1530	3,0	-	-
W90190 - 32-40	P0401200	XT15	DT1530	3,0	-	-
A90190 - 40-63	P0401200	XT15	DT1530	3,0	-	-
A90190 - 80	P0401200	XT15	DT1530	3,0	J0123510	SD6368-12
A90190 - 100	P0401200	XT15	DT1530	3,0	J0164110	SD6368-16
A90190 -125	P0401200	XT15	DT1530	3,0	J0204610	SD6368-20

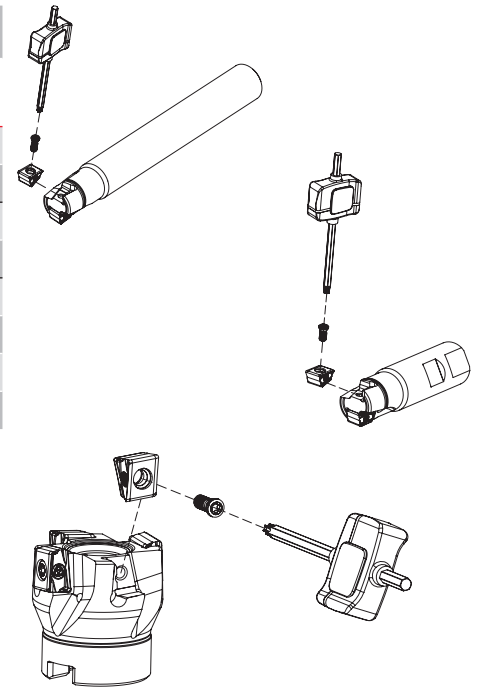

Note: The toolholder is supplied with the XT/PT key. To order the DT key please check the page A-241.
Check the procedures for the clamping screws on the page A-241.

GRADES SELECTION GUIDE | Guia para selección de graus | Tabla para selección de calidades

ISO	PSM	Material	HB (Brinell)	Grades			
				← Wear Resistance		Toughness →	
				PH5320	PHP920	PHS740	PH7740
P	1	Unalloyed Steel	125-220	●	✓	✓	✓
	2	Low-Alloyed Steel	220-280	●	✓	✓	✓
	3	High-Alloyed Steel	280-380	●	✓	✓	✓
M	4	SS - Ferritic / Martensitic	200-330	●			✓
	5	SS - Austenitic	200-330	●			✓
	6	SS - Austenitic-ferritic (Duplex)	230-260	●			✓
K	7	Malleable Cast Iron	130-230	✓	✓		✓
	8	Grey Cast Iron	180-245	✓	✓		✓
	9	Nodular Cast iron	160-250	✓	✓		✓

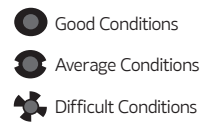

RECOMMENDED CUTTING CONDITIONS | Condições de corte recomendadas | Condiciones de corte recomendables

ISO	PSM	Material	HB (Brinell)	Vc (m/min)				Feed fz (mm/t)
				← Wear Resistance			Toughness →	
				PH5320	PHP920	PHS740	PH7740	
P	1	Unalloyed Steel	125-220	-	180-250	140-220	140-200	0,10-0,35
	2	Low-Alloyed Steel	220-280	-	160-230	120-200	130-180	0,10-0,30
	3	High-Alloyed Steel	280-380	-	140-220	100-190	100-170	0,10-0,20
M	4	SS - Ferritic / Martensitic	200-330	-	-	-	-	0,10-0,30
	5	SS - Austenitic	200-330	-	-	-	-	0,10-0,25
	6	SS - Austenitic-ferritic (Duplex)	230-260	-	-	-	-	0,10-0,20
K	7	Malleable Cast Iron	130-230	150-280	170-300	-	140-220	0,10-0,35
	8	Grey Cast Iron	180-245	160-320	150-250	-	120-210	0,10-0,30
	9	Nodular Cast iron	160-250	100-190	90-210	-	100-190	0,10-0,25

(Note 1) Cutting conditions $a_e/D_c=70\%$.

(Note 2) It's possible to occur vibrations in certain cases. Please reduce depth of cut and / or reduce cutting conditions in following cases:

- When using long shank;
- When using long tool overhang with arbor type;
- When application has poor clamping rigidity or when using a low rigidity machine.

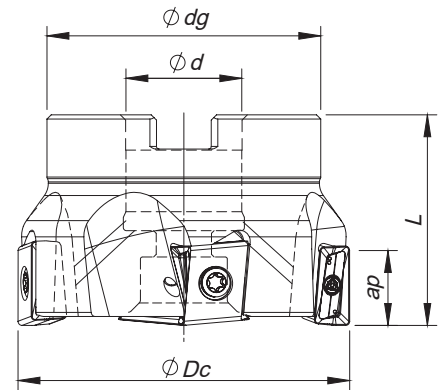
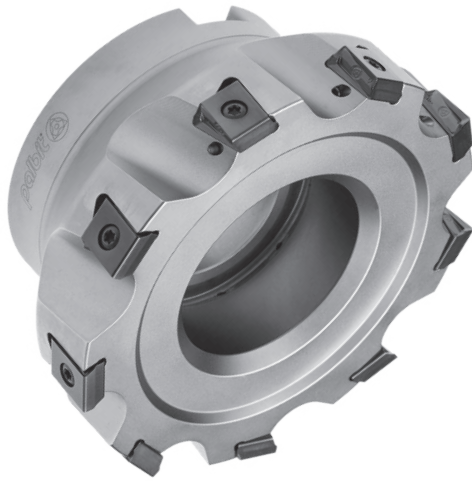

Arbor Mounting
 $K_r=90^\circ$ | $\gamma_p=-5^\circ$

Order code Código	Reference Referência Referencia		Dimensions Dimensões Dimensiones (mm)				Kg	Specifications		Insert Pastilha Inserto	Stock
			ϕDc	ϕd	ϕdg	L		Arbor Type	Ap max (mm)		
181069200	050A90390-05-05-022040	5	50	22	42	40	0,315	A	14,0	LNXT 1506...	
181066400	063A90390-05-05-022040	5	63	22	52	40	0,524	A	14,0	LNXT 1506...	
181051000	063A90390-08-05-022040	8	63	22	52	40	0,550	A	14,0	LNXT 1506...	
181066500	080A90390-07-05-027050	7	80	27	60	50	0,936	B	14,0	LNXT 1506...	
181052000	080A90390-10-05-027050	10	80	27	60	50	0,939	B	14,0	LNXT 1506...	
181066600	100A90390-08-05-032050	8	100	32	80	50	1,586	B	14,0	LNXT 1506...	
181051100	100A90390-12-05-032050	12	100	32	80	50	1,690	B	14,0	LNXT 1506...	
181066700	125A90390-09-05-040063	9	125	40	90	63	3,001	B	14,0	LNXT 1506...	
181051200	125A90390-15-05-040063	15	125	40	90	63	3,113	B	14,0	LNXT 1506...	
181051300	160A90390-10-05-U040063	10	160	40	110	63	4,470	C	14,0	LNXT 1506...	
181066800	160A90390-20-05-U040063	20	160	40	110	63	4,580	C	14,0	LNXT 1506...	

Stock item | Produto de stock | Itens de stock

Available under request (see page A-8) | Disponível sobre consulta (consulte a página A-8) | Disponible bajo consulta (mire pagina A-8)

SPARE PARTS | Complementos | Repuestos

Cutter ϕDc	Insert Screw	Order separately			Order separately	
		Key (Torx)	Key (Torx - Nm)	Torque Value	Screw	DIN 6368 Wrench
A90390 - 50 - 63	P0401200	XT15	DT1530	3,0	-	-
A90390 - 80	P0401200	XT15	DT1530	3,0	J0123510	SD6368-12
A90390 - 100	P0401200	XT15	DT1530	3,0	J0164110	SD6368-16
A90390 - 125	P0401200	XT15	DT1530	3,0	J0204610	SD6368-20
A90390 - 160	P0401200	XT15	DT1530	3,0	-	-

Note: The toolholder is supplied with the XT/PT key. To order the DT key please check the page A-241.
 Check the procedures for the clamping screws on the page A-241.

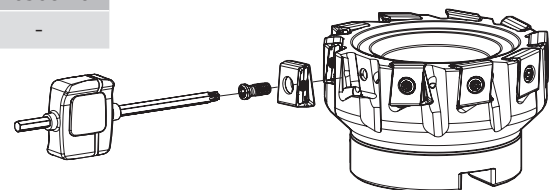

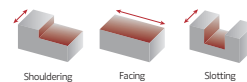

LNXT 1506... | Inserts | Pastilhas | Plaquetas

LNXT-HP

LNXT-MP
(PHP grade)

LNXT - MP | HP

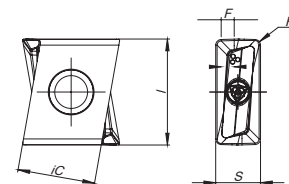

LNXT-W

LNXT-W

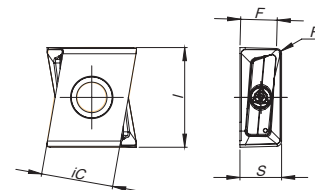

	(2) Grade code	P					K						Dimensions Dimensões Dimensiones (mm)					
		CVD		PVD			CVD		PVD									
(1) Geometry code	ISO Reference	T9	G1	G4	T1	G6	L5	L9	G1	G4	T1	G6	iC	S	I	R	F	
1111313	LNXT 150608 PNER-MP	☉	☉	☉	☹	☉	☉	☉	☉	☉	☹	☉	11,0	6,35	15,0	0,8	1,8	
1111590	LNXT 150612 PNER-MP			☉	☹	☉	☉	☉		☉	☹	☉	11,0	6,35	15,0	1,2	1,8	
1111591	LNXT 150608 PNSR-HP			☹		☉				☹		☉	11,0	6,35	15,0	0,8	1,8	
1111524	LNXT 150608 PNER-W		☉				☹		☉				11,0	6,35	15,2	0,8	5,5	

☉ First choice | Primeira opção | 1ª opción ☉ Stock item | Produto de stock | Itens de stock ○ Available under request (see page A-9) | Disponível sobre consulta (consulte a página A-9) | Disponible bajo consulta (mire página A-9) Insert order code = (1) Geometry Code + (2) Grade Code

GRADES SELECTION GUIDE | Guia para selecção de graus | Tabla para selección de calidades

ISO	PSM	Material	HB (Brinell)	Grades						
				← Wear Resistance				Toughness →		
				PH5705	PH7910	PHP920	PH7920	PH5740	PHS740	PH7740
P	1	Unalloyed Steel	125-220	☹	☉	☉	☉	☹	☉	☉
	2	Low-Alloyed Steel	220-280	☹	☉	☉	☉	☹	☉	☉
	3	High-Alloyed Steel	280-380	☹	☉	☉	☉	☹	☉	☉
K	7	Malleable Cast Iron	130-230	☉	☉	☉	☉	☉	☹	☉
	8	Grey Cast Iron	180-245	☉	☉	☉	☉	☉	☹	☉
	9	Nodular Cast iron	160-250	☉	☉	☉	☉	☉	☹	☉

☉ Good Conditions ☹ Average Conditions ☹ Difficult Conditions

RECOMMENDED CUTTING CONDITIONS | Condições de corte recomendadas | Condiciones de corte recomendables

ISO	PSM	Material	HB (Brinell)	Vc (m/min)						
				← Wear Resistance					Toughness →	
				PH5705	PH7910	PHP920	PH7920	PH5740	PHS740	PH7740
P	1	Unalloyed Steel	125-220	-	180-250	180-250	180-240	-	140-220	140-200
	2	Low-Alloyed Steel	220-280	-	160-230	160-230	160-220	-	120-200	130-180
	3	High-Alloyed Steel	280-380	-	140-220	140-220	140-210	-	100-190	100-170
K	7	Malleable Cast Iron	130-230	160-290	180-300	160-270	160-260	160-260	-	140-220
	8	Grey Cast Iron	180-245	170-320	160-250	140-250	140-240	140-240	-	120-210
	9	Nodular Cast iron	160-250	140-200	150-200	120-210	120-200	120-200	-	100-190

ISO	PSM	Material	HB (Brinell)	Feed fz (mm/t)		
				LNXT 15... MP	LNXT 15... HP	LNXT 15... W
				P	1	Unalloyed Steel
2	Low-Alloyed Steel	220-280	0,10-0,30		0,10-0,30	0,10-0,35
3	High-Alloyed Steel	280-380	0,10-0,25		0,10-0,25	0,10-0,35
K	7	Malleable Cast Iron	130-230	0,10-0,40	0,10-0,40	0,10-0,50
	8	Grey Cast Iron	180-245	0,10-0,35	0,10-0,35	0,10-0,50
	9	Nodular Cast iron	160-250	0,10-0,30	0,10-0,30	0,10-0,50

(Note 1) Cutting conditions $a_e/D_c=70\%$.

(Note 2) It's possible to occur vibrations in certain cases. Please reduce depth of cut and / or reduce cutting conditions in following cases:

- When using long shank;
- When using long tool overhang with arbor type;
- When application has poor clamping rigidity or when using a low rigidity machine.

CHIP-BREAKER SELECTION GUIDE | Guia para aplicações do quebra- aparas | Guía para aplicación del rompevirutas

ISO	PSM	Material	HB (Brinell)	Chip-Breaker Application	
				1st choise	Difficult Operations
P	1	Unalloyed Steel	125-220	LNXT 15... MP	LNXT 15... HP
	2	Low-Alloyed Steel	220-280	LNXT 15... MP	LNXT 15... HP
	3	High-Alloyed Steel	280-380	LNXT 15... MP	LNXT 15... HP
K	7	Malleable Cast Iron	130-230	LNXT 15... MP	LNXT 15... HP
	8	Grey Cast Iron	180-245	LNXT 15... MP	LNXT 15... HP
	9	Nodular Cast iron	160-250	LNXT 15... MP	LNXT 15... HP

WIPER INSERTS

Rec. Cutting Conditions

- F_w at least 40% larger than f_n ($f_n - f_z \times Z$);
- Axial depth of cut is 0,5 - 0,8mm.

Example:

- The width of the parallel land (F) of the insert is 1,8mm
- With a cutter of 10 inserts and using a feed per tooth (f_z) of 0,3mm, the feed per revolution (f_n) will be 3mm, i.e. 40% bigger than the parallel land.
- To obtain a good surface finish, the feed per revolution should be a maximum of 80% of 1,8mm = 1,44mm.
- The wiper insert will have a parallel land (F_w) with a width of approximately 5,5mm.
- Result: Feed per revolution (f_n) could be increased from 0,8mm to 60% of 5,5mm = 3,3mm.

Note: Other limitations, such as machine power, must be taken into consideration.

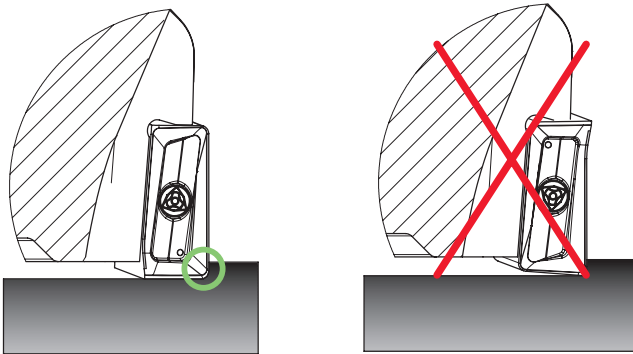

The points on the insert indicates the side that should be parallel to the workspace material.

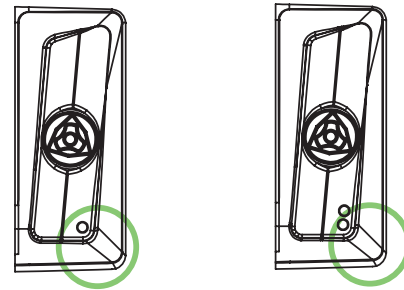

Wiper insert with 2 Right-hand cutting edges.
The side work of the insert it's indicated by points.

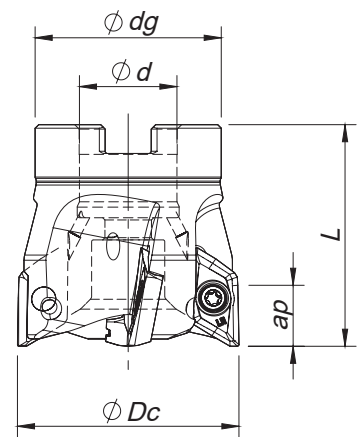

Arbor Mounting

$K_r=90^\circ$ | $\gamma_p=+11^\circ$

Order code Código	Reference Referência Referencia		Dimensions Dimensões Dimensiones (mm)				Kg	Specifications			Insert radius Raio da pastilha Rayo del Inserto	Stock
			ϕDc	ϕd	ϕdg	L		Cutter Type	Max ap (mm)	rpm max		
181094200	040A76090-03-11-016050-A	3	40	16	32	50	0,3	A	14,0	29 000	0,4-3,2	
181083400	050A76090-04-11-022050-A	4	50	22	42	50	0,4	A	14,0	24 000	0,4-3,2	
181085300	063A76090-05-11-022050-A	5	63	22	48	50	0,7	A	14,0	21 000	0,4-3,2	
181094300	080A76090-05-11-027050-A	5	80	27	60	50	1,1	A	14,0	19 000	0,4-3,2	
181094400	100A76090-06-11-032063-A	6	100	32	73	63	2,0	A	14,0	16 000	0,4-3,2	
181094500	040A76090-03-11-016050-B	3	40	16	32	50	0,3	B	14,0	29 000	4,0-5,0	
181094600	050A76090-04-11-022050-B	4	50	22	42	50	0,4	B	14,0	24 000	4,0-5,0	
181094700	063A76090-05-11-022050-B	5	63	22	48	50	0,7	B	14,0	21 000	4,0-5,0	
181094800	080A76090-05-11-027050-B	5	80	27	60	50	1,1	B	14,0	19 000	4,0-5,0	
181094900	100A76090-06-11-032063-B	6	100	32	73	63	2,0	B	14,0	16 000	4,0-5,0	

Stock item | Produto de stock | Itens de stock

Available under request (see page A-8) | Disponível sobre consulta (consulte a página A-8) | Disponible bajo consulta (mire pagina A-8)

Note: Type A cutters can only assemble inserts with a radius between 0,4 and 3,2. Type B cutters can only assemble inserts with a radius between 4,0 and 5,0.

SPARE PARTS | Complementos | Repuestos

Cutter ϕDc	Insert Screw	Key (Torx)	Order separately	
			Key (Torx - Nm)	Torque Value
A76090- 40-80	P0400900	XT15	DT1530	3,0
A76090 - 100	P0400900	PT15	DT1530	3,0
E76090 - 20-25	P0400803	XT15	DT1530	3,0
E76090 - 32-40	P0400900	XT15	DT1530	3,0

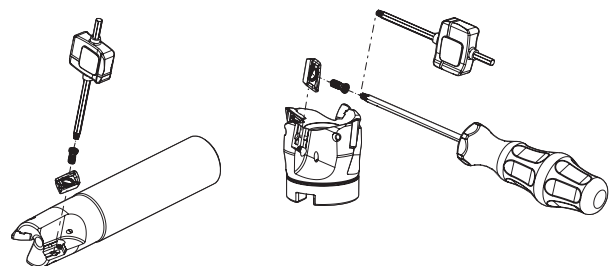

Note: The toolholder is supplied with the XT/PT key. To order the DT key please check the page A-241. Check the procedures for the clamping screws on the page A-241.

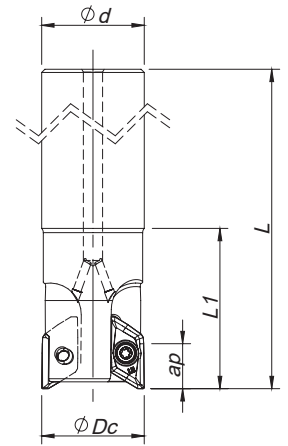
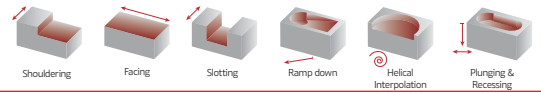

Cylindrical Shank

$K_r=90^\circ \mid \gamma_p=+6^\circ \sim +11^\circ$

Order code Código	Reference Referência Referencia		Dimensions Dimensões Dimensiones (mm)				Kg	Specifications			Insert radius Raio da pastilha Rayo del Inserto	Stock
			ØDc	Ød	L	L1		Cutter Type	Max ap (mm)	rpm max		
181095000	020E76090-01-06-020150-A		20	20	150	60	0,2	A	15,0	40 000	0,4~3,2	
181095100	025E76090-02-09-025180-A		25	25	180	90	0,4	A	15,0	38 000	0,4~3,2	
181095200	032E76090-02-09-032200-A		32	32	200	120	0,7	A	15,0	33 000	0,4~3,2	
181095300	040E76090-03-11-032250-A		40	32	250	65	1,4	A	15,0	29 000	0,4~3,2	
181095400	020E76090-01-06-020150-B		20	20	150	60	0,2	B	15,0	40 000	4,0~5,0	
181095500	025E76090-02-09-025180-B		25	25	180	90	0,4	B	15,0	38 000	4,0~5,0	
181095600	032E76090-02-09-032200-B		32	32	200	120	0,7	B	15,0	33 000	4,0~5,0	
181095700	040E76090-03-11-032250-B		40	32	250	65	1,4	B	15,0	29 000	4,0~5,0	

Stock item | Produto de stock | Itens de stock

Available under request (see page A-8) | Disponível sobre consulta (consulte a página A-8) | Disponible bajo consulta (mire pagina A-8)

Note: Type A cutters can only assemble inserts with a radius between 0,4 and 3,2. Type B cutters can only assemble inserts with a radius between 4,0 and 5,0.

XDGX 15M5... || Inserts | Pastilhas | Plaquetas

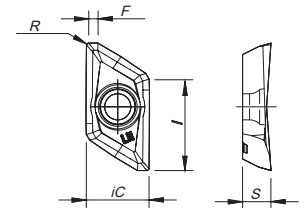

(1) Geometry code	ISO Reference	N UNC 10 PH0910	Dimensions Dimensões Dimensiones (mm)					Cutter Type
			iC	S	I	R	F	
1111624	XDGX 15M504 PDFR-LN		11,20	5,00	16,0	0,40	1,50	A
1111625	XDGX 15M508 PDFR-LN		11,20	5,00	16,0	0,80	1,10	A
1111626	XDGX 15M512 PDFR-LN		11,20	5,00	16,0	1,20	0,70	A
1111627	XDGX 15M516 PDFR-LN		11,20	5,00	16,0	1,60	0,40	A
1111628	XDGX 15M520 PDFR-LN		11,20	5,00	16,0	2,00	0,20	A
1112154	XDGX 15M530 PDFR-LN		11,20	5,00	16,0	3,00	0,60	A
1111629	XDGX 15M532 PDFR-LN		11,20	5,00	16,0	3,20	0,60	A
1111630	XDGX 15M540 PDFR-LN		11,20	5,00	16,0	4,00	0,50	B
1111631	XDGX 15M550 PDFR-LN		11,20	5,00	16,0	5,00	0,40	B

First choice | Primeira opção | 1ª opción

Stock item | Produto de stock | Itens de stock

Available under request (see page A-9) | Disponível sobre consulta (consulte a página A-9) | Disponible bajo consulta (mire pagina A-9)

Insert order code = (1) Geometry Code + (2) Grade Code

ALUPRO 76090

RECOMMENDED CUTTING CONDITIONS | Condições de corte recomendadas | Condiciones de corte recomendables

SHOULDERING							
ISO	PSM	Material	HB (Brinell)	Vc (m/min)	Width of Cut ae (mm)	Depth of Cut ap (mm)	Feed fz(mm/t)
				PH0910			
N	10	Aluminium and Non Ferrous	30-130	350-3000	≤ 25% ØDc	≤5.0	0,35 - 0,40
						5.0 - 10.0	0,30 - 0,35
						10.0 - 15.0	0,25 - 0,30
					< 50% ØDc	≤5.0	0,35 - 0,40
						5.0 - 10.0	0,30 - 0,35
						10.0 - 15.0	0,25 - 0,30
					≤ 75% ØDc	≤5.0	0,30 - 0,35
						5.0 - 10.0	0,25 - 0,30
						10.0 - 15.0	0,20 - 0,25

SLOTING							
ISO	PSM	Material	HB (Brinell)	Vc (m/min)	Width of Cut ae (mm)	Depth of Cut ap (mm)	Feed fz(mm/t)
				PH0910			
N	10	Aluminium and Non Ferrous	30-130	350-3000	100% ØDc	≤5.0	0,25 - 0,35
						5.0 - 10.0	0,20 - 0,30
						10.0 - 15.0	0,15 - 0,25

(Note 1) Cutting conditions $a_e/D_c=70\%$.

(Note 2) It's possible to occur vibrations in certain cases. Please reduce depth of cut and / or reduce cutting conditions in following cases:

- When using long shank;
- When using long tool overhang with arbor type;
- When application has poor clamping rigidity or when using a low rigidity machine.

(Note 3) Use internal coolant supply

OPERATIONAL GUIDE | Guia operacional | Guía operativa

- The maximum allowable revolutions are shown in Table 1. Ensure that the cutter operates under the maximum allowable revolutions. The maximum allowable revolutions for safety purposes are determined in accordance with ISO 15641 (Milling Cutters for high speed machining-Safety requirements).

Table 1 - Maximum allowable revolutions:

ØDc	Ø20	Ø25	Ø32	Ø40	Ø50	Ø63	Ø80	Ø100
RPM (min ⁻¹)	40000	38000	33000	29000	24000	21000	19000	16000

- Even when operating under the maximum allowable spindle speed, if the spindle speed is equal or higher than the values shown in Table 2., it is recommended that the balance quality (with the arbor or chuck) according ISO 1940.

Table 2 - Maximum revolutions when balancing with the arbor or chuck has not been achieved:

ØDc	Ø20	Ø25	Ø32	Ø40	Ø50	Ø63	Ø80	Ø100
RPM (min ⁻¹)	15000	12000	9500	8500	7600	6800	6000	5400

- When setting the spindle speed, take into consideration the maximum allowable revolutions of arbor or chuck.
- Use the specified set bolt when using the arbor type with internal coolant supply.

RAMPING AND HELICAL INTERPOLATION

Descida em rampa e interpolação helicoidal | Bajada en rampa e interpolación circular

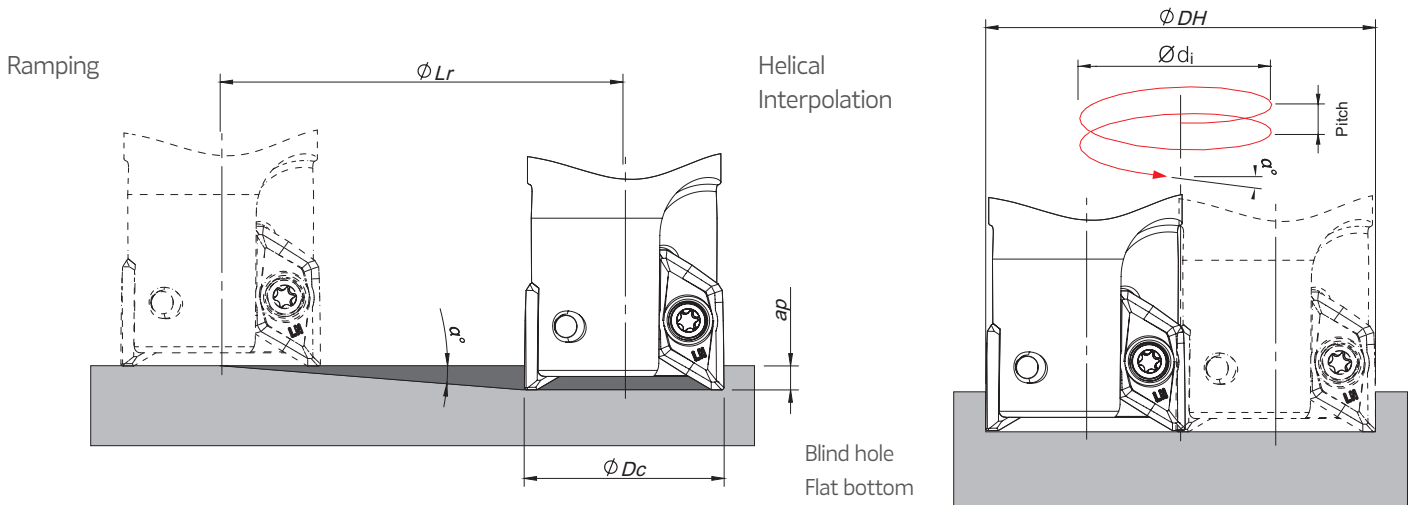

$$\phi_{di} = \phi_{DH} - \phi_{Dc}$$

Cutter Type	ϕ_{Dc}	Ramping			Helical Interpolation		
		Max Ramp a°	Max a_p	Min L_r	Diameter for Blind Hole, Flat Bottom Face (1)		Max Pitch/Rev.
					ϕ_{DHmin}	ϕ_{DHmax}	
A	20	23	15,0	35,3	36,2	-	21,6
	25	21	15,0	39,1	46,2	-	24,5
	32	15	15,0	56,0	60,2	-	25,6
	40	10	15,0	85,1	76,2	-	23,7
	50	8	15,0	106,7	96,2	-	25,6
	63	6	15,0	142,7	122,2	-	20,0
	80	4	15,0	214,5	156,2	-	21,3
	100	2,5	15,0	343,6	196,2	-	20,4
B	20	20	13,5	37,1	36,2	-	18,5
	25	18,5	13,5	40,3	46,2	-	21,0
	32	13,5	13,5	56,2	60,2	-	22,3
	40	8,5	13,5	90,3	76,2	-	24,6
	50	7	13,5	109,9	96,2	-	21,3
	63	5,5	13,5	140,2	122,2	-	22,9
	80	3,5	13,5	220,7	156,2	-	17,0
	100	2,5	13,5	309,2	196,2	-	18,0

(1) using insert radius 0,8 mm

Note: During helical interpolation do not exceed maximum pitch.
When using different insert radius to calculate the ϕ_{DHmin} and ϕ_{DHmax} use the equation below:
- Minimum Diameter: $\phi_{DHmin} = 2 \times (\phi_{Dc} - (R \text{ corner radius} + F \text{ width of edge wiper}))$
- Maximum Diameter: $\phi_{DHmax} = 2 \times (\phi_{Dc} - R \text{ corner radius})$

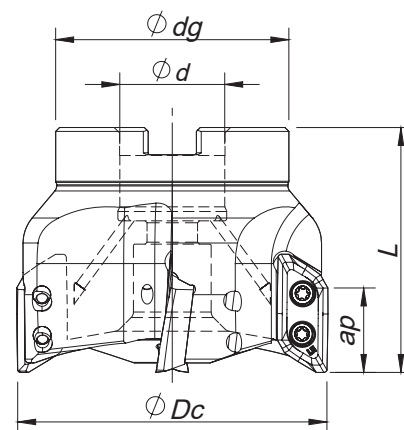

Arbor Mounting

$K_r=90^\circ$ | $\gamma_p=+7^\circ$

Order code Código	Reference Referência Referencia		Dimensions Dimensões Dimensiones (mm)				Kg	Specifications			Insert radius Raio da pastilha Rayo del Inserto	Stock
			ϕDc	ϕd	ϕdg	L		Cutter Type	Max ap (mm)	rpm max		
181093000	050A77090-03-07-022050-A	3	50	22	42	50	0,4	A	21,5	30 000	0,8~3,2	
181093100	063A77090-03-07-022050-A	3	63	22	42	50	0,5	A	21,5	25 000	0,8~3,2	
181071600	080A77090-04-07-027063-A	4	80	27	60	63	1,2	A	21,5	23 000	0,8~3,2	
181093200	100A77090-05-07-032063-A	5	100	32	70	63	1,8	A	21,5	19 000	0,8~3,2	
181093300	125A77090-06-07-040063-A	6	125	40	100	63	2,7	A	21,5	16 000	0,8~3,2	
181093400	050A77090-03-07-022050-B	3	50	22	42	50	0,4	B	21,0	30 000	4,0~5,0	
181093500	063A77090-03-07-022050-B	3	63	22	42	50	0,5	B	21,0	25 000	4,0~5,0	
181093600	080A77090-04-07-027063-B	4	80	27	60	63	1,2	B	21,0	23 000	4,0~5,0	
181093700	100A77090-05-07-032063-B	5	100	32	70	63	1,8	B	21,0	19 000	4,0~5,0	
181093800	125A77090-06-07-040063-B	6	125	40	100	63	2,7	B	21,0	16 000	4,0~5,0	

Stock item | Produto de stock | Itens de stock

Available under request (see page A-8) | Disponível sobre consulta (consulte a página A-8) | Disponible bajo consulta (mire pagina A-8)

Note: Type A cutters can only assemble inserts with a radius between 0,4 and 3,2. Type B cutters can only assemble inserts with a radius between 4,0 and 5,0.

SPARE PARTS | Complementos | Repuestos

Cutter ϕDc	Insert Screw	Key (Torx)	Order separately		Order separately	
			Key (Torx - Nm)	Torque Value	Screw	DIN 6368 Wrench
A77090 - 50-80	P0401200	XT15	DT1530	3,0	-	-
A77090 - 100	P0401200	PT15	DT1530	3,0	J0164110	SD6368-16
A77090 - 125	P0401200	PT15	DT1530	3,0	J0204610	SD6368-20
E77090 - 32-40	P0401200	XT15	DT1530	3,0	-	-

Note: The toolholder is supplied with the XT/PT key. To order the DT key please check the page A-241.
Check the procedures for the clamping screws on the page A-241.

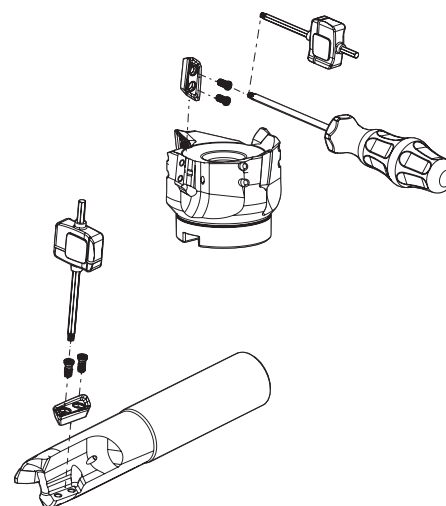

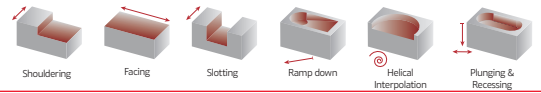

Cylindrical Shank
 $K_r=90^\circ$ | $\gamma_p=+6^\circ$

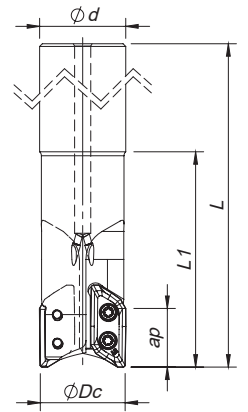

Order code Código	Reference Referência Referencia		Dimensions Dimensões Dimensiones (mm)				Kg	Specifications			Insert radius Raio da pastilha Rayo del Inserto	Stock
			ØDc	Ød	L	L1		Cutter Type	Max ap (mm)	rpm max		
181069800	032E77090-02-06-032170-A	2	32	32	170	80	0,8	A	21.5	41 000	0,8~3,2	☉
181093900	040E77090-02-06-040170-A	2	40	40	170	80	0,9	A	21.5	36 000	0,8~3,2	☉
181094000	032E77090-02-06-032170-B	2	32	32	170	80	0,8	B	21.0	41 000	4,0~5,0	○
181094100	040E77090-02-06-040170-B	2	40	40	170	80	0,9	B	21.0	36 000	4,0~5,0	☉

☉ Stock item | Produto de stock | Itens de stock

○ Available under request (see page A-8) | Disponível sobre consulta (consulte a página A-8) | Disponible bajo consulta (mire pagina A-8)

Note: Type A cutters can only assemble inserts with a radius between 0,4 and 3,2. Type B cutters can only assemble inserts with a radius between 4,0 and 5,0.

XDGX 22M7... | Inserts | Pastilhas | Plaquetas

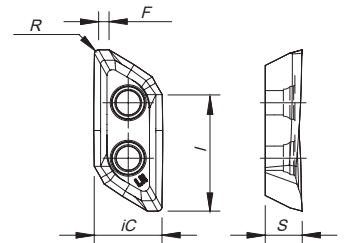

(1) Geometry code	ISO Reference	N		Dimensions Dimensões Dimensiones (mm)					Cutter Type
		UNC	10	iC	S	I	R	F	
1111618	XDGX 22M708 PDFR-LN	☉	☉	13,00	7,00	22,0	0,80	2,00	A
1111619	XDGX 22M716 PDFR-LN	☉	☉	13,00	7,00	22,0	1,60	1,20	A
1111620	XDGX 22M720 PDFR-LN	☉	☉	13,00	7,00	22,0	2,00	0,80	A
1111621	XDGX 22M732 PDFR-LN	☉	☉	13,00	7,00	22,0	3,20	0,60	A
1111622	XDGX 22M740 PDFR-LN	☉	☉	13,00	7,00	22,0	4,00	0,90	B
1111623	XDGX 22M750 PDFR-LN	☉	☉	13,00	7,00	22,0	5,00	0,40	B

☉ First choice | Primeira opção | 1ª opción

☉ Stock item | Produto de stock | Itens de stock

○ Available under request (see page A-9) | Disponível sobre consulta (consulte a página A-9) | Disponible bajo consulta (mire pagina A-9)

Insert order code = (1) Geometry Code + (2) Grade Code

ALUPRO 77090

RECOMMENDED CUTTING CONDITIONS | Condições de corte recomendadas | Condiciones de corte recomendables

SHOULDERING							
ISO	PSM	Material	HB (Brinell)	Vc (m/min)	Width of Cut ae (mm)	Depth of Cut ap (mm)	Feed fz(mm/t)
				PH0910			
N	10	Aluminium and Non Ferrous	30-130	350-3000	≤ 25% ØDc	≤5.0	0,35 - 0,40
						5.0 - 10.0	0,30 - 0,35
						10.0 - 15.0	0,25 - 0,30
						15.0 - 20.0	0,20 - 0,25
					< 50% ØDc	≤5.0	0,35 - 0,40
						5.0 - 10.0	0,30 - 0,35
						10.0 - 15.0	0,25 - 0,30
						15.0 - 20.0	0,20 - 0,25
					≤ 75% ØDc	≤5.0	0,30 - 0,35
						5.0 - 10.0	0,25 - 0,30
						10.0 - 15.0	0,20 - 0,25
						15.0 - 20.0	0,15 - 0,20

SLOTING							
ISO	PSM	Material	HB (Brinell)	Vc (m/min)	Width of Cut ae (mm)	Depth of Cut ap (mm)	Feed fz(mm/t)
				PH0910			
N	10	Aluminium and Non Ferrous	30-130	350-3000	100% ØDc	≤5.0	0,25 - 0,35
						5.0 - 10.0	0,20 - 0,30
						10.0 - 15.0	0,15 - 0,25
						15.0 - 20.0	0,10 - 0,20

(Note 1) Cutting conditions $a_e/D_c=70\%$.

(Note 2) It's possible to occur vibrations in certain cases. Please reduce depth of cut and / or reduce cutting conditions in following cases:

- When using long shank;
- When using long tool overhang with arbor type;
- When application has poor clamping rigidity or when using a low rigidity machine.

(Note 3) Use internal coolant supply.

OPERATIONAL GUIDE | Guia operacional | Guía operativa

- Only use the inserts and parts provided by Palbit with this tool. Use of the correct insert clamp screws is especially important to ensure overall tool safety. Do not use damaged or worn clamp screws.

- When tightening the clamp screws, follow the order in Figure 1. The recommended torque value is 3.5Nm.

- The maximum allowable revolutions are shown in Table 1. Ensure that the cutter operates under the maximum allowable revolutions.

The maximum allowable revolutions for safety purposes are determined in accordance with ISO 15641 (Milling Cutters for high speed machining-Safety requirements).

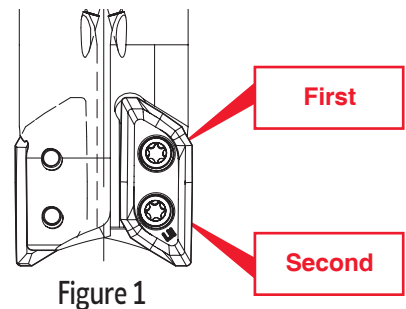

Table 1 - Maximum allowable revolutions:

ØDc	Ø32	Ø40	Ø50	Ø63	Ø80	Ø100	Ø125
RPM (min ⁻¹)	41000	36000	30000	25000	23000	19000	16000

- Even when operating under the maximum allowable spindle speed, if the spindle speed is equal or higher than the values shown in Table 2., it is recommended that the balance quality (with the arbor or chuck) according ISO 1940.

Table 2 - Maximum revolutions when balancing with the arbor or chuck has not been achieved:

ØDc	Ø32	Ø40	Ø50	Ø63	Ø80	Ø100	Ø125
RPM (min ⁻¹)	9500	7600	6000	4800	3800	3000	2400

- When setting the spindle speed, take into consideration the maximum allowable revolutions of arbor or chuck.
- Use the specified set bolt when using the arbor type with internal coolant supply.

RAMPING AND HELICAL INTERPOLATION

Descida em rampa e interpolação helicoidal | Bajada en rampa e interpolación circular

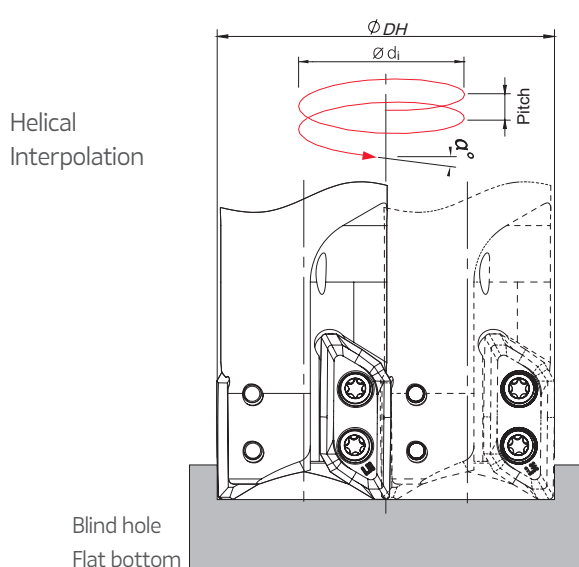
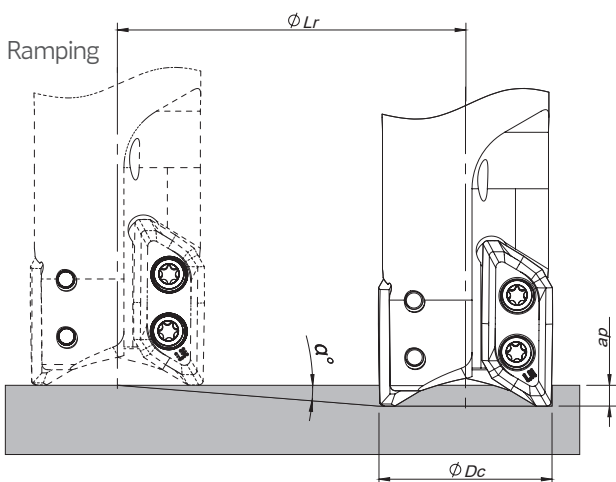

$$\phi_{di} = \phi_{DH} - \phi_{Dc}$$

Cutter Type	ϕ_{Dc}	Ramping			Helical Interpolation		
		Max Ramp a°	Max a_p	Min Lr	Diameter for Blind Hole, Flat Bottom Face (1)		Max Pitch/Rev.
					ϕ_{DHmin}	ϕ_{DHmax}	
A	32	19	21,5	62,4	60,0 -	- 62,4	30,3 32,9
	40	13	21,5	93,1	76,0 -	- 78,4	26,1 27,8
	50	9	21,5	135,7	96,0 -	- 98,4	22,9 24,1
	63	7	21,5	175,1	122,0 -	- 124,4	22,7 23,7
	80	5	21,5	245,7	156,0 -	- 158,4	20,9 21,5
	100	4	21,5	307,5	196,0 -	- 198,4	21,1 21,6
	125	3	21,5	410,2	246,0 -	- 248,4	19,9 20,3
B	32	18	21,0	64,6	60,0 -	- 62,4	28,6 31,0
	40	11	21,0	108,0	76,0 -	- 78,4	22,0 23,4
	50	8	21,0	149,4	96,0 -	- 98,4	20,3 21,4
	63	6	21,0	199,8	122,0 -	- 124,4	19,5 20,3
	80	4	21,0	300,3	156,0 -	- 158,4	16,7 17,2
	100	3	21,0	400,7	196,0 -	- 198,4	15,8 16,2
	125	2	21,0	601,4	246,0 -	- 248,4	13,3 13,5

(1) using insert radius 0,8 mm

Note: During helical interpolation do not exceed maximum pitch.

When using different insert radius to calculate the ϕ_{DHmin} and ϕ_{DHmax} use the equation below:

- Minimum Diameter: $\phi_{DHmin} = 2 \times (\phi_{Dc} - (R \text{ corner radius} + F \text{ width of edge wiper}))$

- Maximum Diameter: $\phi_{DHmax} = 2 \times (\phi_{Dc} - R \text{ corner radius})$

ALUPRO 08390

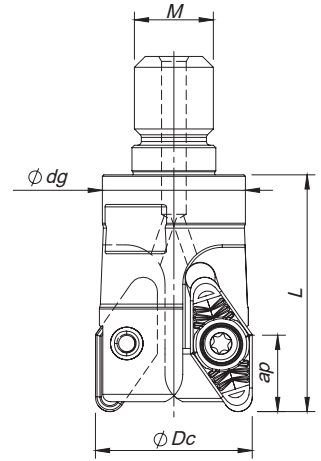

Threaded Coupling

$$K_r = 90^\circ \quad | \quad \gamma_p = 0^\circ$$

Order code Código	Reference Referência Referencia		Dimensions Dimensões Dimensiones (mm)				Kg	Specifications	Insert Pastilha Inserto	Stock
			ϕDc	$\phi d/M$	ϕdg	L		A_p max (mm)		
181019900	032R08390-02-M16048	2	32	M16	29	48	0,19	15,00	VCGX 22...	

Stock item | Produto de stock | Itens de stock

Available under request (see page A-8) | Disponível sobre consulta (consulte a página A-8) | Disponible bajo consulta (mire página A-8)

VCGX 220530 | Inserts | Pastilhas | Plaquetas

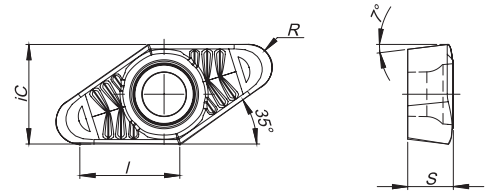

(1) Geometry code	ISO Reference	N		Dimensions Dimensões Dimensiones (mm)			
		UNC	10	iC	S	L	R
1121907	VCGX 220530 LN			12,70	5,60	12,7	3,00

First choice | Primeira opção | 1ª opción

Stock item | Produto de stock | Itens de stock

Available under request (see page A-8) | Disponível sobre consulta (consulte a página A-8) | Disponible bajo consulta (mire página A-8)

Insert order code = (1) Geometry Code + (2) Grade Code

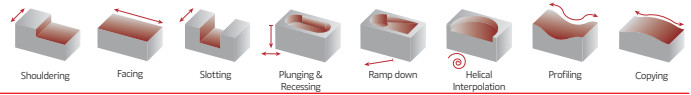

SPARE PARTS | Complementos | Repuestos

Cutter ØDc	Insert Screw	Key (Torx)	Order separately	
			Key (Torx - Nm)	Torque Value
R08390 - 32	P0451001	XT20	DT2050	5,00

Note: The toolholder is supplied with the XT/PT key. To order the DT key please check the page A-241.
Check the procedures for the clamping screws on the page A-241.

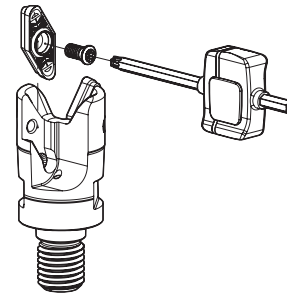

RECOMMENDED CUTTING CONDITIONS | Condições de corte recomendadas | Condiciones de corte recomendables

ISO	PSM	Material	HB (Brinell)	Vc (m/min)	Feed fz (mm/t)
				PH0910	VCGX 22...
N	10	Aluminium and Non Ferrous	30-130	350-1400	0,20-0,50

ØDc	Ø32
RPM (min ⁻¹)	9500

(Note 1) Cutting conditions $a_e/D_c=70\%$.

(Note 2) It's possible to occur vibrations in certain cases. Please reduce depth of cut and / or reduce cutting conditions in following cases:

- When using long shank;
- When using long tool overhang with arbor type;
- When application has poor clamping rigidity or when using a low rigidity machine.

(Note 3) Use internal coolant supply

RAMPING AND HELICAL INTERPOLATION

Descida em rampa e interpolação helicoidal | Bajada en rampa e interpolación circular

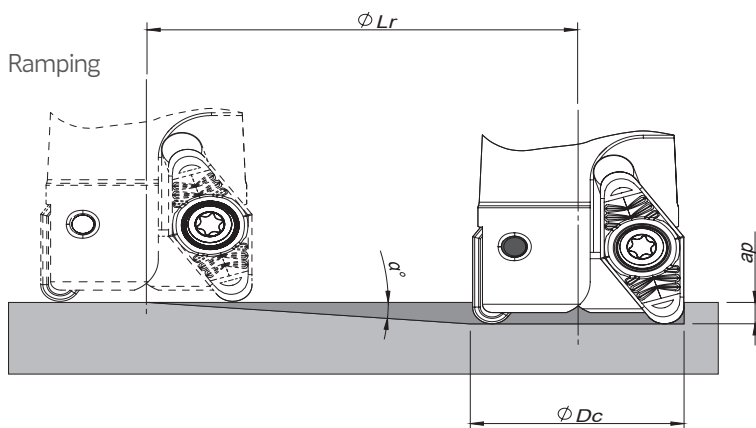

Helical Interpolation

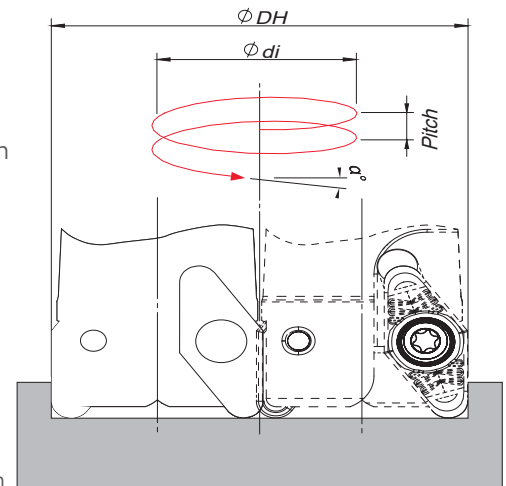

$$\text{Ødi} = \text{ØDH} - \text{ØDc}$$

ØDc	Ramping			Helical Interpolation		
	Max Ramp a°	Max ap	Min Lr	ØDHmin	ØDHmax	Max Pitch/Rev.
32	6,8	15,0	25,4	53,0	-	7,0
				-	62,0	11,0

Note: During helical interpolation do not exceed max Pitch.

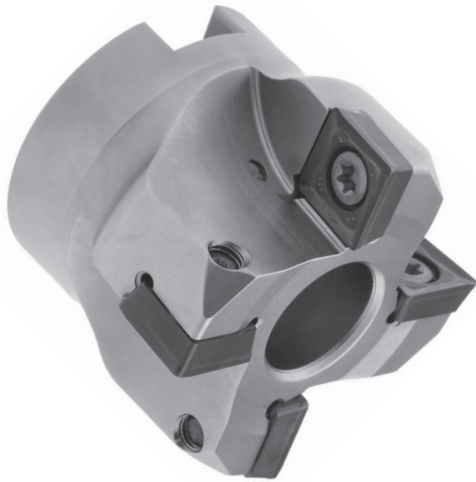

Arbor Mounting

$K_r=90^\circ$ | $\gamma_p=+6^\circ$

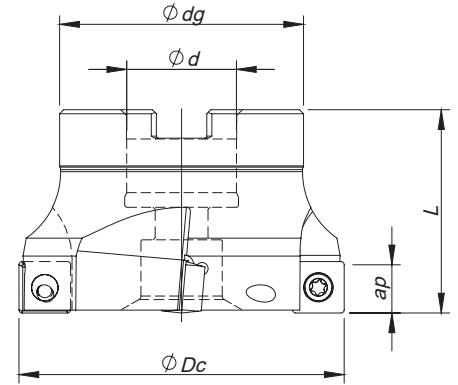

Order code Código	Reference Referência Referencia		Dimensions Dimensões Dimensiones (mm)				Kg	Specifications		Insert Pastilha Inserto	Stock
			ϕDc	ϕd	ϕdg	L		Arbor Type	Ap max (mm)		
181167700	040A06290-03-06-016040		40	16	39	40	0,2	A	11	SP...1204	
181167800	050A06290-04-06-022040		50	22	49	40	0,35	A	11	SP...1204	
181167900	063A06290-05-06-027050		63	27	60	50	0,7	A	11	SP...1204	
181168000	080A06290-06-06-027050		80	27	64	50	1,15	A	11	SP...1204	
181168100	100A06290-08-06-032050		100	32	78	50	1,75	A	11	SP...1204	
181168200	125A06290-08-06-040063		125	40	96	63	3,05	B	11	SP...1204	
181065600	160A06290-10-06-U040063		160	40	100	63	4,2	C	11	SP...1204	

Stock item | Produto de stock | Itens de stock

Available under request (see page A-8) | Disponível sobre consulta (consulte a página A-8) | Disponible bajo consulta (mire pagina A-8)

SP... 1204... || Inserts | Pastilhas | Plaquitas

SPMX - MP

NEW



SPGX-MS

NEW



PHH

NEW
GRADE

PHP

NEW
GRADE

SPGX-MP | SPMW-MS

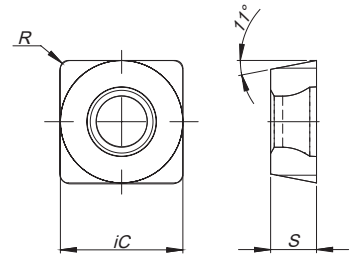

		P	M	K	S	Dimensions Dimensões Dimensiones (mm)		
		PVD	PVD	PVD	PVD	iC	S	R
⁽²⁾ Grade code		T1	X9	T1	X9			
⁽¹⁾ Geometry code	ISO Reference	PHH920	PHH930	PHP920	PHP930			
1113002	SPGX 120408 PDSR-MP					12,73	4,8	0,8
1113003	SPGX 120408 PDSR-MS					12,73	4,8	0,8
1112916	SPMX 120408 PDSR-MP					12,73	4,8	0,8
1112999	SPMX 120408 PDSR-MS					12,73	4,8	0,8

First choice | Primeira opção | 1ª opción

Stock item | Produto de stock | Itens de stock

Available under request (see page A-9) | Disponível sobre consulta (consulte a página A-9) | Disponible bajo consulta (mire pagina A-9)

Insert order code = (1) Geometry Code + (2) Grade Code

SPMT 120408-MP

SPMW 120408



Page A - 50

Note: It is possible to use other inserts - Page A - 50

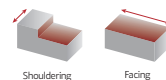

SPARE PARTS | Complementos | Repuestos

Cutter ØDc	Insert Screw	Key (Torx)	Order separately	
			Key (Torx - Nm)	Torque Value
A06290 – 40 - 160	P0501100	PT20	DT2050	5,00

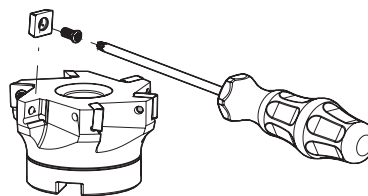

Note: The toolholder is supplied with the XT/PT key. To order the DT key please check the page A-241.
Check the procedures for the clamping screws on the page A-241.

RECOMMENDED CUTTING CONDITIONS | Condições de corte recomendadas | Condiciones de corte recomendables

ISO	PSM	Material	HB (Brinell)	Vc (m/min)		Feed fz (mm/t)	
				← Wear Resistance	Toughness →	SPG(M)X...MP	SPM(M)X...MS
				PHP920	PHH930		
P	1	Unalloyed Steel	125-220	180-250	-	0,08-0,20	-
	2	Low-Alloyed Steel	220-280	170-210	-	0,08-0,20	-
	3	High-Alloyed Steel	280-380	160-200	-	0,08-0,20	-
M	4	SS - Ferritic / Martensitic	200-330	-	120-180	-	0,08-0,20
	5	SS - Austenitic	200-330	-	100-160	-	0,08-0,20
	6	SS - Austenitic-ferritic (Duplex)	230-260	-	70-140	-	0,08-0,20
K	7	Malleable Cast Iron	130-230	170-300	-	0,10-0,30	-
	8	Grey Cast Iron	180-245	150-250	-	0,10-0,30	-
	9	Nodular Cast iron	160-250	90-210	-	0,10-0,30	-
S	11	Heat Resistant Super Alloys	200-320	-	30-75	-	0,08-0,15

(Note 1) Cutting conditions ae/DC=70%

(Note 2) Cutting conditions should be adjusted according to the machine and work rigidity.

(Note 3) If chattering occurs, reduce ap and Vc by 30% and keep the same fz per tooth.

CHIP-BREAKER SELECTION GUIDE | Guia para aplicações do quebra- aparas | Guía para aplicación del rompevirutas

ISO	PSM	Material	HB (Brinell)	Chip-Breaker Application	
				1st choice	Difficult Operations
P	1	Unalloyed Steel	125-220	... MS	... MP
	2	Low-Alloyed Steel	220-280	... MS	... MP
	3	High-Alloyed Steel	280-380	... MP	... MP
M	4	SS - Ferritic / Martensitic	200-330	... MS	... MP
	5	SS - Austenitic	200-330	... MS	... MS
	6	SS - Austenitic-ferritic (Duplex)	230-260	... MS	... MS
K	7	Malleable Cast Iron	130-230	... MP	... MP
	8	Grey Cast Iron	180-245	... MP	... MP
	9	Nodular Cast iron	160-250	... MP	... MP
S	11	Heat Resistant Super Alloys	200-320	... MS	... MS

LINEPRO 17090

A

MILLING

Overview

Face milling

Hi-feed milling

Shoulder milling

Profile milling

Hardmill

Center & Chamfer

Spot face

Spare Parts

Technical Data

End Mills

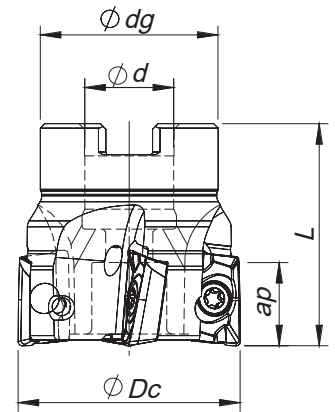

Arbor Mounting

$K_r=90^\circ$ | $\gamma_p=+9^\circ$

Order code Código	Reference Referência Referencia		Dimensions Dimensões Dimensiones (mm)				Kg	Specifications		Insert Pastilha Inserto	Stock
			ϕDc	ϕd	ϕdg	L		Arbor Type	Ap max (mm)		
181010200	040A17090-06-09-022040	6	40	22	39	40	0,210	A	9,0	AP... 1003...	
181010300	050A17090-07-09-022040	7	50	22	40	40	0,320	A	9,0	AP... 1003...	
181014300	063A17090-08-09-022040	8	63	22	48	40	0,560	A	9,0	AP... 1003...	

Stock item | Produto de stock | Itens de stock

Available under request (see page A-8) | Disponível sobre consulta (consulte a página A-8) | Disponible bajo consulta (mire pagina A-8)

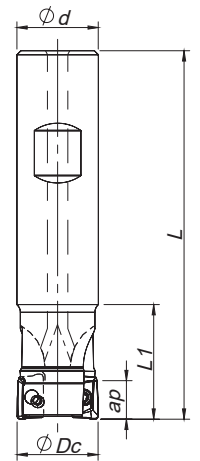

Weldon Shank

$K_r=90^\circ$ | $\gamma_p=+7^\circ \sim +9^\circ$

Order code Código	Reference Referência Referencia		Dimensions Dimensões Dimensiones (mm)				Kg	Specifications		Insert Pastilha Inserto	Stock
			ϕDc	ϕd	L	L1		Ap max (mm)			
181041300	016W17090-02-07-016085	2	16	16	85	26	0,110	9,0	AP... 1003...		
181031700	016W17090-02-07-016150	2	16	16	150	26	0,210	9,0	AP... 1003...		
181041400	020W17090-03-09-020090	3	20	20	90	28	0,190	9,0	AP... 1003...		
181041600	020W17090-03-09-020150	3	20	20	150	28	0,320	9,0	AP... 1003...		
181041700	025W17090-04-09-020150	4	25	20	150	26	0,340	9,0	AP... 1003...		
181041500	025W17090-04-09-025095	4	25	25	95	30	0,310	9,0	AP... 1003...		

Stock item | Produto de stock | Itens de stock

Available under request (see page A-8) | Disponível sobre consulta (consulte a página A-8) | Disponible bajo consulta (mire pagina A-8)

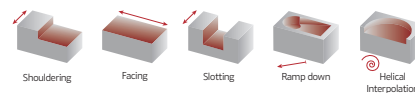

Threaded Coupling

$$K_r = 90^\circ \mid \gamma_p = +7^\circ \sim +9^\circ$$

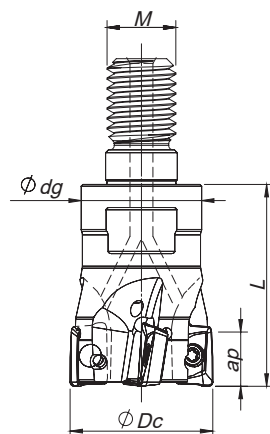

Order code Código	Reference Referência Referencia		Dimensions Dimensões Dimensiones (mm)				Kg	Specifications		Insert Pastilha Inserto	Stock
			ØDc	ØM	Ødg	L		Ap max (mm)			
181015100	016R17090-02-07-M08025	2	16	M8	13	25	0,030	9,0	AP... 1003...		
181015200	020R17090-03-09-M10030	3	20	M10	18	30	0,058	9,0	AP... 1003...		
181015300	025R17090-04-09-M12035	4	25	M12	21	35	0,110	9,0	AP... 1003...		

Stock item | Produto de stock | Itens de stock

Available under request (see page A-8) | Disponível sobre consulta (consulte a página A-8) | Disponible bajo consulta (mire pagina A-8)

AP... 1003... || Inserts | Pastilhas | Plaquetas

APET - LN

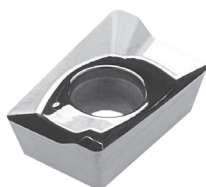

APKT - X

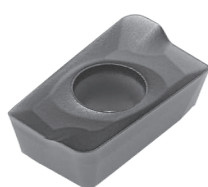

APKT - X1

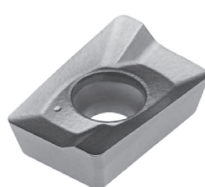

APET-LN | APKT-X | APKT-X1

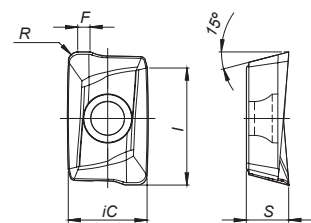

Geometry code	ISO Reference	P		M	K		N	Dimensions Dimensões Dimensiones (mm)				
		PVD		PVD	PVD		UNC	iC	S	I	R	F
		68	66	66	68	66	10					
⁽¹⁾		PH6920	PH6930	PH6930	PH6920	PH6930	PH0910					
1112043	APET 100305 PDFR-LN							6,70	3,50	10,00	0,50	1,20
1112168	APKT 100305 PDER-X1							6,70	3,50	10,00	0,50	1,20
1112167	APKT 100305 PDSR-X1							6,70	3,50	10,00	0,50	1,20
1111071	APKT 100308 PDER-X							6,70	3,50	10,00	0,80	0,90
1111044	APKT 100308 PDSR-X							6,70	3,50	10,00	0,80	0,90
1111042	APKT 100308 PDTR-X							6,70	3,50	10,00	0,80	0,90
1111072	APKT 100312 PDER-X							6,70	3,50	10,00	1,20	-
1110987	APKT 100312 PDSR-X							6,70	3,50	10,00	1,20	-
1111045	APKT 100312 PDTR-X							6,70	3,50	10,00	1,20	-

First choice | Primeira opção | 1ª opción

Stock item | Produto de stock | Itens de stock

Available under request (see page A-9) | Disponível sobre consulta (consulte a página A-9) | Disponible bajo consulta (mire pagina A-9)

Insert order code = (1) Geometry Code + (2) Grade Code

LINEPRO 17090

SPARE PARTS | Complementos | Repuestos

Cutter ØDc	Insert Screw	Key (Torx)	Order separately	
			Key (Torx - Nm)	Torque Value
W17090 - 16-25	P0250503	XT08	DT0812	1,2
R17090 - 16-25	P0250503	XT08	DT0812	1,2
A17090 - 40-63	P0250503	XT08	DT0812	1,2

Note: The toolholder is supplied with the XT/PT key. To order the DT key please check the page A-241. Check the procedures for the clamping screws on the page A-241.

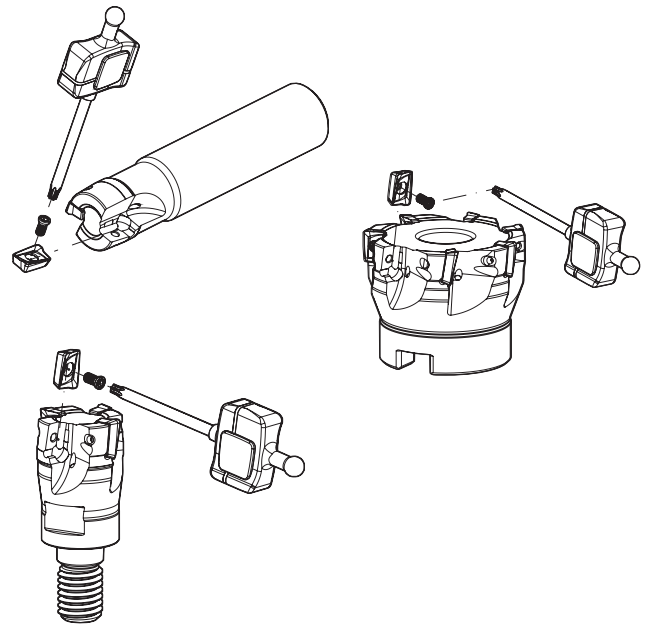

GRADES SELECTION GUIDE | Guia para selección de graus | Tabla para selección de calidades

ISO	PSM	Material	HB (Brinell)	Grades		
				← Wear Resistance		Toughness →
				PH0910	PH6920	PH6930
P	1	Unalloyed Steel	125-220	●	✓	✓
	2	Low-Alloyed Steel	220-280		✓	✓
	3	High-Alloyed Steel	280-380		✓	✓
M	4	SS - Ferritic / Martensitic	200-330			✓
	5	SS - Austenitic	200-330			✓
	6	SS - Austenitic-ferritic (Duplex)	230-260			✓
K	7	Malleable Cast Iron	130-230		✓	✓
	8	Grey Cast Iron	180-245		✓	✓
	9	Nodular Cast iron	160-250		✓	✓
N	10	Aluminium and Non Ferrous	30-130	✓		

- Good Conditions
- Average Conditions
- Difficult Conditions

CHIP-BREAKER SELECTION GUIDE | Guia para aplicações do quebra-afaras | Guía para aplicación del rompevirutas

ISO	PSM	Material	HB (Brinell)	Chip-Breaker Application	
				1st choice	Difficult Operations
P	1	Unalloyed Steel	125-220	APKT 10... PDER-X	APKT 10... PDTR-X
	2	Low-Alloyed Steel	220-280	APKT 10... PDSR-X	APKT 10... PDSR-X
	3	High-Alloyed Steel	280-380	APKT 10... PDSR-X	-
M	4	SS - Ferritic / Martensitic	200-330	APKT 10... PDER-X	-
	5	SS - Austenitic	200-330	APKT 10... PDER-X	-
	6	SS - Austenitic-ferritic (Duplex)	230-260	APKT 10... PDER-X	-
K	7	Malleable Cast Iron	130-230	APKT 10... PDER-X	APKT 10... PDSR-X
	8	Grey Cast Iron	180-245	APKT 10... PDSR-X	-
	9	Nodular Cast iron	160-250	APKT 10... PDSR-X	-
N	10	Aluminium and Non Ferrous	30-130	APET 10... PDFR-LN	-

RAMPING AND HELICAL INTERPOLATION

Descida em rampa e interpolação helicoidal | Bajada en rampa e interpolación circular

Ramping

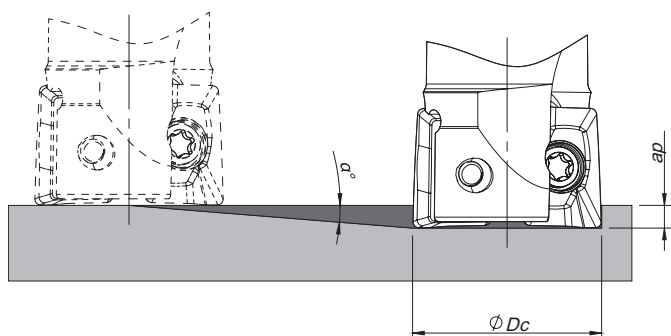

Helical Interpolation

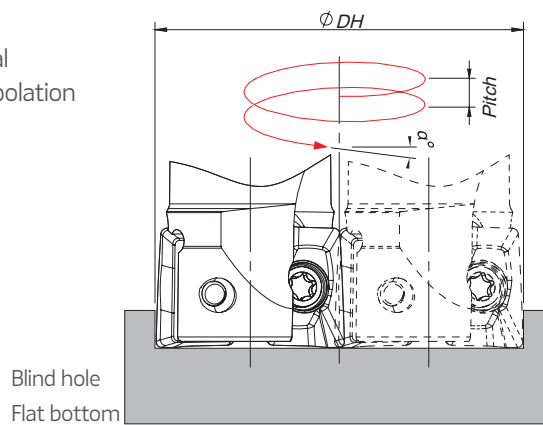

$$\varnothing di = \varnothing DH - \varnothing Dc$$

ØDc	Ramping			Helical Interpolation		
	Max Ramp a°	Max ap	Min Lr	Diameter for Blind Hole, Flat Bottom Face (1)		Max Pitch/Rev.
				ØDHmin	ØDHmax	
16	1,3	9,0	396,6	29,2	-	0,9
				-	31,0	1,1
20	0,9	9,0	572,9	37,2	-	0,8
				-	39,0	0,9
25	0,6	9,0	859,4	47,2	-	0,7
				-	49,0	0,8
40	0,4	9,0	1289,1	77,2	-	0,8
				-	79,0	0,9
50	0,25	9,0	2062,6	97,2	-	0,6
				-	99,0	0,7
63	0,2	9,0	2578,3	123,2	-	0,7
				-	125,0	0,7

(1) using LP insert with radius 0,8 mm

Note: During helical interpolation do not exceed maximum pitch

When using HF insert or other different insert radius to calculate the ØDHmin and ØDHmax use the equation below:

- Minimum Diameter: $\varnothing DH_{min} = 2 \times (\varnothing Dc - (R \text{ corner radius} + F \text{ width of edge wiper}))$

- Maximum Diameter: $\varnothing DH_{max} = 2 \times (\varnothing Dc - R \text{ corner radius})$

LINEPRO 17090

RECOMMENDED CUTTING CONDITIONS | Condições de corte recomendadas | Condiciones de corte recomendables

ISO	PSM	Material	HB (Brinell)	Vc (m/min)		
				← Wear Resistance		Toughness →
				PH0910	PH6920	PH6930
P	1	Unalloyed Steel	125-220	-	180-240	160-220
	2	Low-Alloyed Steel	220-280	-	160-220	140-200
	3	High-Alloyed Steel	280-380	-	140-210	120-190
M	4	SS - Ferritic / Martensitic	200-330	-	140-220	140-200
	5	SS - Austenitic	200-330	-	130-180	120-160
	6	SS - Austenitic-ferritic (Duplex)	230-260	-	120-160	100-140
K	7	Malleable Cast Iron	130-230	-	160-260	150-240
	8	Grey Cast Iron	180-245	-	140-240	140-230
	9	Nodular Cast iron	160-250	-	120-200	100-190
N	10	Aluminium and Non Ferrous	30-130	100-2000	-	-

(Note 1) Cutting conditions $a_e/D_c=70\%$.

(Note 2) Cutting conditions for slotting and shouldering operations:

Operation	a_e	Vc & fz	a_p (mm)
Slotting	100%	<20%	3,0-4,0
	<50%	>8%	5,0-6,0
Shouldering	≤25%	>12%	7,0-8,0

(Note 3) Cutting conditions should be adjusted according to the machine and work rigidity.

(Note 4) It's possible to occur vibrations in certain cases. Please reduce depth of cut and / or reduce cutting conditions in following cases:

- When using long shank;
- When using long tool overhang with arbor type;
- When application has poor clamping rigidity or when using a low rigidity machine.

(Note 5) If chattering occurs, reduce a_p and Vc by 30% and keep the same fz per tooth.

Feed fz (mm/t)		
APKT 10... PDER-X/X1	APKT 10... PDS(T)R-X/X1	APET 10... PDFR-LN
0,07-0,15	0,10-0,25	-
0,07-0,10	0,10-0,20	-
0,07-0,10	0,10-0,20	-
0,07-0,10	-	-
0,07-0,10	-	-
0,07-0,10	-	-
0,07-0,15	0,10-0,25	-
0,07-0,15	0,10-0,25	-
-	0,10-0,20	-
-	-	0,07-0,20

LINEPRO 18090

A

MILLING

Overview

Face milling

Hi-feed milling

Shoulder milling

Profile milling

Hardmill

Center & Chamfer

Spot face

Spare Parts

Technical Data

End Mills

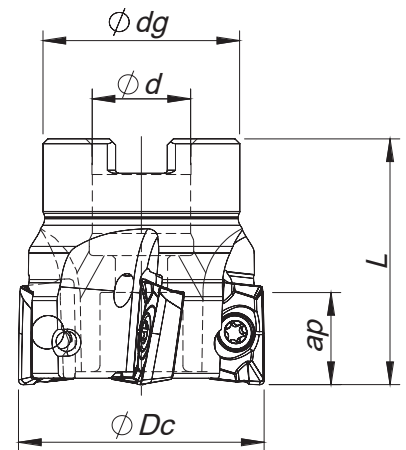
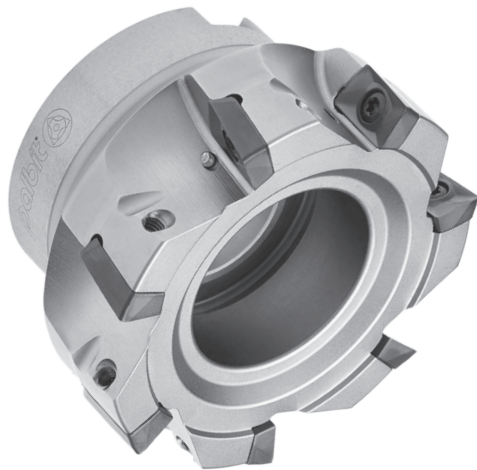

Arbor Mounting

$K_r=90^\circ$ | $\gamma_p=+8^\circ \sim +10^\circ$

Order code Código	Reference Referência Referencia		Dimensions Dimensões Dimensiones (mm)				Kg	Specifications		Insert Pastilha Inserto	Stock
			ϕDc	ϕd	ϕdg	L		Arbor Type	Ap max (mm)		
181031200	040A18090-04-08-016040	4	40	16	32	40	0,180	A	14,5	AP.. 1604	
181030900	050A18090-05-08-022040	5	50	22	42	40	0,290	A	14,5	AP.. 1604	
181031300	063A18090-06-09-022040	6	63	22	52	40	0,530	A	14,5	AP.. 1604	
181031400	080A18090-07-10-027050	7	80	27	60	50	0,920	B	14,5	AP.. 1604	
181031500	100A18090-08-10-032050	8	100	32	80	50	1,680	B	14,5	AP.. 1604	
181031600	125A18090-09-10-040063	9	125	40	90	63	3,010	B	14,5	AP.. 1604	

Stock item | Produto de stock | Itens de stock

Available under request (see page A-8) | Disponível sobre consulta (consulte a página A-8) | Disponible bajo consulta (mire página A-8)

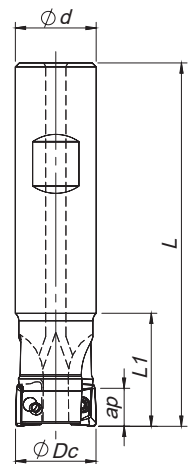

Weldon Shank

$K_r=90^\circ$ | $\gamma_p=+6^\circ \sim +8^\circ$

Order code Código	Reference Referência Referencia		Dimensions Dimensões Dimensiones (mm)				Kg	Specifications		Insert Pastilha Inserto	Stock
			ϕDc	ϕd	L	L1		Ap max (mm)			
181041800	025W18090-02-06-025100	2	25	25	100	44	0,310	14,5	AP.. 1604		
181042100	025W18090-02-06-025200	2	25	25	200	60	0,670	14,5	AP.. 1604		
181041900	032W18090-03-07-032110	3	32	32	110	50	0,560	14,5	AP.. 1604		
181042200	032W18090-03-07-032200	3	32	32	200	60	1,100	14,5	AP.. 1604		
181042000	040W18090-04-08-032115	4	40	32	115	40	0,670	14,5	AP.. 1604		
181042300	040W18090-04-08-032200	4	40	32	200	40	1,190	14,5	AP.. 1604		

Stock item | Produto de stock | Itens de stock

Available under request (see page A-8) | Disponível sobre consulta (consulte a página A-8) | Disponible bajo consulta (mire página A-8)

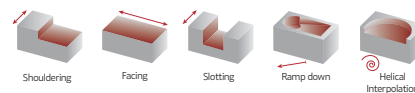

SPARE PARTS | Complementos | Repuestos

Cutter ØDc	Insert Screw	Key (Torx)	Order separately	
			Key (Torx - Nm)	Torque Value
W18090 - 25-40	P0400900	XT15	DT1530	3,0
A18090 - 40-80	P0400900	XT15	DT1530	3,0
A18090 - 100-125	P0400900	PT15	DT1530	3,0

Note: The toolholder is supplied with the XT/PT key. To order the DT key please check the page A-241. Check the procedures for the clamping screws on the page A-241.

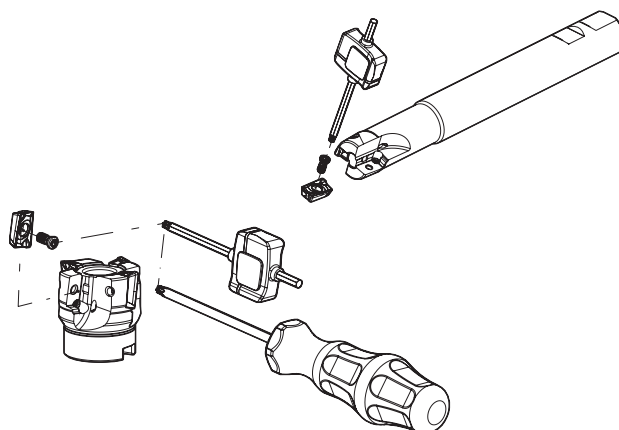

AP... 1604... | Inserts | Pastilhas | Plaquetas

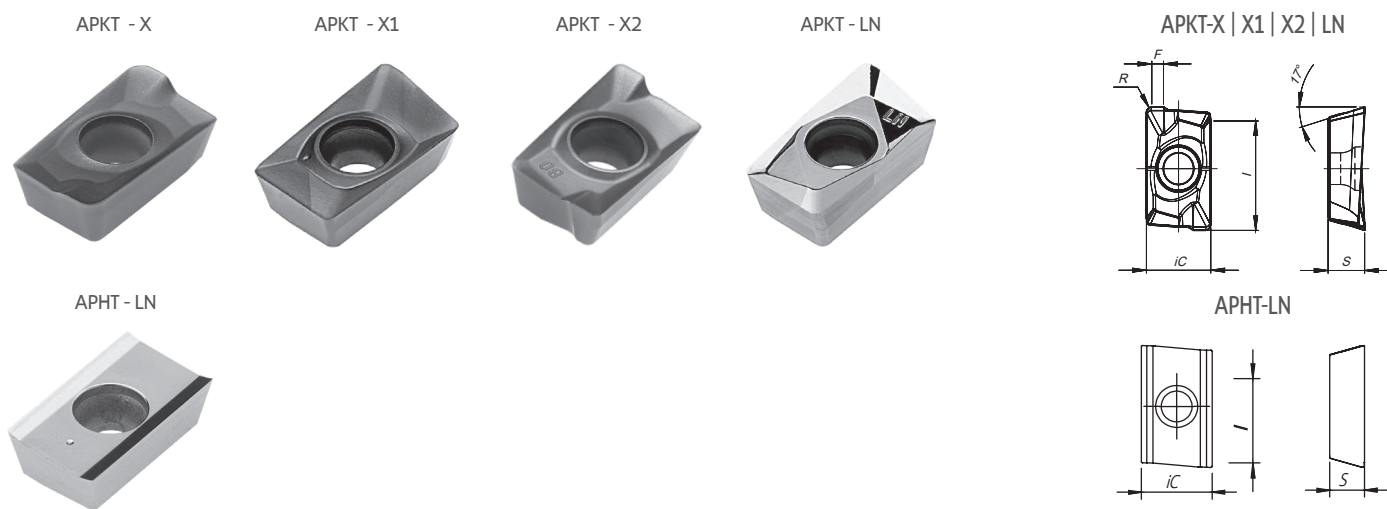

		P				M		K				N	Dimensions Dimensões Dimensiones (mm)				
		PVD				PVD		PVD				UNC					
		⁽²⁾ Grade code		68	G4	66	P3	66	P3	68	G4	66					
⁽¹⁾ Geometry code	ISO Reference	PH6920	PH7920	PH6930	PH7930	PH6930	PH7930	PH6920	PH7920	PH6930	PH7930	PH0910	iC	S	I	R	F
1112159	APKT 160408 PDER-X1	⊗		⊗		⊗		⊗		⊗			9,45	5,35	16,00	0,80	1,80
1112464	APKT 160408 PDER-X2		⊗		⊗		⊗		⊗		⊗		9,45	5,35	16,00	0,80	1,80
1112158	APKT 160408 PDSR-X1	⊗		⊗				⊗		⊗			9,45	5,35	16,00	0,80	1,80
1112367	APKT 160408 PDSR-X2		⊗		⊗				⊗		⊗		9,45	5,35	16,00	0,80	1,80
1111923	APKT 160408 PDFR-LN											⊗	9,45	5,35	16,00	0,80	0,80
1111074	APKT 160416 PDER-X	⊗						⊗					9,45	5,35	16,00	1,60	1,20
1111050	APKT 160416 PDSR-X	⊗		⊗				⊗		⊗			9,45	5,35	16,00	1,60	1,20
1111075	APKT 160432 PDER-X	⊗						⊗					9,45	5,35	16,00	3,20	-
1111052	APKT 160432 PDSR-X	⊗						⊗					9,45	5,35	16,00	3,20	-
1111924	APHT 1604 PDFR-LN											⊗	9,45	5,35	16,00	-	-

⊗ First choice | Primeira opção | 1ª opción ⊗ Stock item | Produto de stock | Itens de stock



○ Available under request (see page A-9) | Disponível sobre consulta (consulte a página A-9) | Disponible bajo consulta (mire página A-9)

Insert order code = (1) Geometry Code + (2) Grade Code

*For inserts with radius above 2.0 mm, the cutter must be adjusted

LINEPRO 18090

GRADES SELECTION GUIDE | Guia para selecção de graus | Tabla para selección de calidades

ISO	PSM	Material	HB (Brinell)	Grades		
				← Wear Resistance		Toughness →
				PH0910 	PH7(6)920 	PH7 (6)30 
P	1	Unalloyed Steel	125-220		✓	✓
	2	Low-Alloyed Steel	220-280		✓	✓
	3	High-Alloyed Steel	280-380		✓	✓
M	4	SS - Ferritic / Martensitic	200-330			✓
	5	SS - Austenitic	200-330			✓
	6	SS - Austenitic-ferritic (Duplex)	230-260			✓
K	7	Malleable Cast Iron	130-230		✓	✓
	8	Grey Cast Iron	180-245		✓	✓
	9	Nodular Cast iron	160-250		✓	✓
N	10	Aluminium and Non Ferrous	30-130	✓		



RECOMMENDED CUTTING CONDITIONS | Condições de corte recomendadas | Condiciones de corte recomendables

ISO	PSM	Material	HB (Brinell)	Vc (m/min)		
				← Wear Resistance		Toughness →
				PH0910	PH7(6)920	PH7(6)930
P	1	Unalloyed Steel	125-220	-	180-240	160-220
	2	Low-Alloyed Steel	220-280	-	160-220	140-200
	3	High-Alloyed Steel	280-380	-	140-210	120-190
M	4	SS - Ferritic / Martensitic	200-330	-	-	140-200
	5	SS - Austenitic	200-330	-	-	120-160
	6	SS - Austenitic-ferritic (Duplex)	230-260	-	-	100-140
K	7	Malleable Cast Iron	130-230	-	160-260	150-240
	8	Grey Cast Iron	180-245	-	140-240	140-230
	9	Nodular Cast iron	160-250	-	120-200	100-190
N	10	Aluminium and Non Ferrous	30-130	100-2000	-	-

ISO	PSM	Material	HB (Brinell)	Feed fz (mm/t)		
				APKT 16... PDER-X/X2		AP...T 16... PDFR-LN
				APKT 16... PDER-X/X2	APKT 16... PDS(T)R-X/X2	AP...T 16... PDFR-LN
P	1	Unalloyed Steel	125-220	0,07-0,15	0,10-0,25	-
	2	Low-Alloyed Steel	220-280	0,07-0,10	0,10-0,20	-
	3	High-Alloyed Steel	280-380	0,07-0,10	0,10-0,20	-
M	4	SS - Ferritic / Martensitic	200-330	0,07-0,10	-	-
	5	SS - Austenitic	200-330	0,07-0,10	-	-
	6	SS - Austenitic-ferritic (Duplex)	230-260	0,07-0,10	-	-
K	7	Malleable Cast Iron	130-230	0,07-0,15	0,10-0,25	-
	8	Grey Cast Iron	180-245	0,07-0,15	0,10-0,25	-
	9	Nodular Cast iron	160-250	-	0,10-0,20	-
N	10	Aluminium and Non Ferrous	30-130	-	-	0,07-0,20

(Note 1) Cutting conditions $a_e/D_c=70\%$.

(Note 2) Cutting conditions for slotting and shouldering operations:

Operation	a_e	Vc & fz	a_p (mm)
Slotting	100%	<20%	5,0-6,0
Shouldering	<50%	>8%	6,0-9,0
	≤25%	>12%	10,0-12,5

(Note 3) Cutting conditions should be adjusted according to the machine and work rigidity.

(Note 4) It's possible to occur vibrations in certain cases. Please reduce depth of cut and / or reduce cutting conditions in following cases:

- When using long shank;
- When using long tool overhang with arbor type;
- When application has poor clamping rigidity or when using a low rigidity machine.

CHIP-BREAKER SELECTION GUIDE | Guia para aplicações do quebra-apanas | Guía para aplicación del rompevirutas

ISO	PSM	Material	HB (Brinell)	Chip-Breaker Application	
				1st choice	Difficult Operations
P	1	Unalloyed Steel	125-220	APKT 16... PDER-X(X2)	APKT 16... PDSR-X(-X2)
	2	Low-Alloyed Steel	220-280	APKT 16... PDSR-X(X2)	-
	3	High-Alloyed Steel	280-380	APKT 16... PDSR-X(X2)	-
M	4	SS - Ferritic / Martensitic	200-330	APKT 16... PDER-X(X2)	-
	5	SS - Austenitic	200-330	APKT 16... PDER-X(X2)	-
	6	SS - Austenitic-ferritic (Duplex)	230-260	APKT 16... PDSR-X(X2)	-
K	7	Malleable Cast Iron	130-230	APKT 16... PDSR-X(X2)	APKT 16... PDSR-X(X2)
	8	Grey Cast Iron	180-245	APKT 16... PDSR-X(X2)	-
	9	Nodular Cast iron	160-250	APKT 16... PDSR-X(X2)	-
N	10	Aluminium and Non Ferrous	30-130	AP...T 16... PDFR-LN	APHT 16... PDFR-LN

RAMPING AND HELICAL INTERPOLATION

Descida em rampa e interpolação helicoidal | Bajada en rampa e interpolación circular

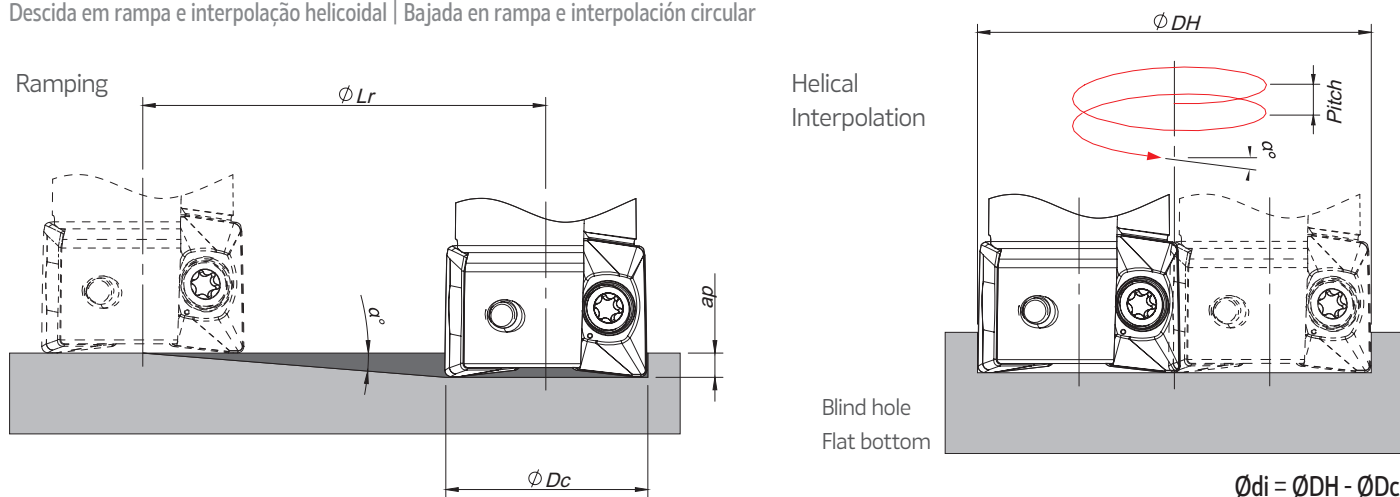

ϕ_{Dc}	Ramping			Helical Interpolation		
	Max Ramp a°	Max a_p	Min L_r	Diameter for Blind Hole, Flat Bottom Face (1)		Max Pitch/Rev.
				ϕ_{DHmin}	ϕ_{DHmax}	
25	3	14,5	276,7	46,1 -	- 48,4	3,5 3,9
32	2	14,5	415,2	60,1 -	- 62,4	3,1 3,3
40	1,5	14,5	553,7	76,1 -	- 78,4	3,0 3,2
50	1,1	14,5	755,2	96,1 -	- 98,4	2,8 2,9
63	0,85	14,5	977,3	122,1 -	- 124,4	2,8 2,9
80	0,64	14,5	1298,1	156,1 -	- 158,4	2,7 2,7
100	0,5	14,5	1661,5	196,1 -	- 198,4	2,6 2,7
125	0,38	14,5	2186,3	246,1 -	- 248,4	2,5 2,6

(1) Using insert radius 0,8 mm

Note: During helical interpolation do not exceed maximum pitch

When using different insert radius to calculate the ϕ_{DHmin} and ϕ_{DHmax} use the equation below:

- Minimum Diameter: $\phi_{DHmin} = 2 \times (\phi_{Dc} - (R \text{ corner radius} + F \text{ width of edge wiper}))$

- Maximum Diameter: $\phi_{DHmax} = 2 \times (\phi_{Dc} - R \text{ corner radius})$

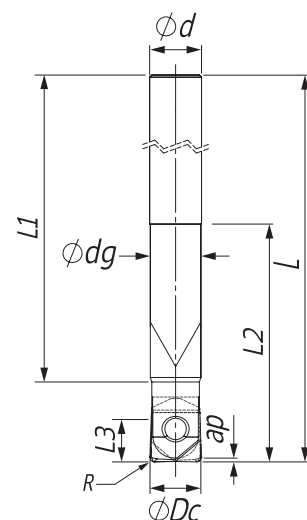

Cylindrical Carbide Shank

Tolerance R	Runout Tolerance
± 0,015	R 0,02

Order code Código	Reference Referência Referencia		Dimensions Dimensões Dimensiones (mm)						Kg	Specifications				Insert	Stock
			ØDc	Ød	Ødg	L	L1	L2		Ap max (mm)		Ae max (mm)			
181156600	008E62090-02-U008140	2	8	8	7,7	140	128	35	0,09	4,0	2,5	0,8	0,8	WCR 08../WCL 08...	
181156700	010E62090-02-U010150	2	10	10	9,7	150	136	45	0,15	5,0	3,0	1,0	1,0	WCR 10../WCL 10...	
181156800	010E62090-02-U010180	2	10	10	9,7	180	166	45	0,18	5,0	3,0	1,0	1,0	WCR 10../WCL 10...	
181155700	012E62090-02-U012165	2	12	12	11,7	165	147	55	0,24	6,0	4,0	1,2	1,2	WCR 12../WCL 12...	
181156900	012E62090-02-U012200	2	12	12	11,7	200	182	55	0,29	6,0	4,0	1,2	1,2	WCR 12../WCL 12...	
181157000	016E62090-02-U016200	2	16	16	15,7	200	180	65	0,51	8,0	5,0	1,6	1,6	WCR 16../WCL 16...	
181157100	016E62090-02-U016250	2	16	16	15,7	250	230	65	0,67	8,0	5,0	1,6	1,6	WCR 16../WCL 16...	
181157200	020E62090-02-U020220	2	20	20	19,7	220	193	70	0,87	10,0	6,0	2,0	2,0	WCR 20../WCL 20...	
181157300	020E62090-02-U020250	2	20	20	19,7	250	223	70	1,00	10,0	6,0	2,0	2,0	WCR 20../WCL 20...	
181157400	020E62090-02-U020300	2	20	20	19,7	300	273	70	1,23	10,0	6,0	2,0	2,0	WCR 20../WCL 20...	

Stock item | Produto de stock | Itens de stock

Available under request (see page A-8) | Disponível sobre consulta (consulte a página A-8) | Disponible bajo consulta (mire pagina A-8)

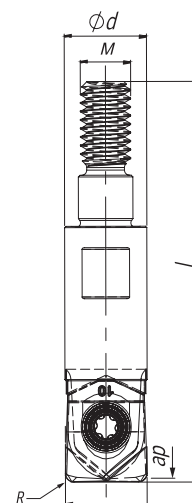

Cylindrical Carbide Shank

Tolerance R	Runout Tolerance
± 0,015	R 0,02

Order code Código	Reference Referência Referencia		Dimensions Dimensões Dimensiones (mm)					Kg	Specifications				Insert	Stock
			ØDc	R	Ød	L	M		Ap max (mm)		Ae max (mm)			
181167000	010R62090-02-UM06030	2	10	5	6,5	30	M6	0,011	5	3,0	1,0	1,0	WCR 10../WCL 10...	
181167100	012R62090-02-UM06030	2	12	6	6,5	30	M6	0,016	6	4,0	1,2	1,2	WCR 10../WCL 10...	
181167200	016R62090-02-UM08030	2	16	8	8,5	30	M8	0,028	8	5,0	1,6	1,6	WCR 12../WCL 12...	
181167300	020R62090-02-UM10035	2	20	10	10,5	35	M10	0,058	10	6,0	2,0	2,0	WCR 12../WCL 12...	

Stock item | Produto de stock | Itens de stock

Available under request (see page A-8) | Disponível sobre consulta (consulte a página A-8) | Disponible bajo consulta (mire pagina A-8)

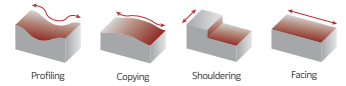

SPARE PARTS Complementos | Repuestos

Cutter ØDc	Insert Screw	Key (Torx)	Order separately	
			Key (Torx) (Torx - Nm)	Torque Value
8	P0300726	XT08	DT0812	1,2
10	P0350825	XT10	DT1020	2,0
12	P0501025	XT20	DT2050	5,0
16	P0501326	XT20	DT2050	5,0
20	P0601725	XT25	-	6,9

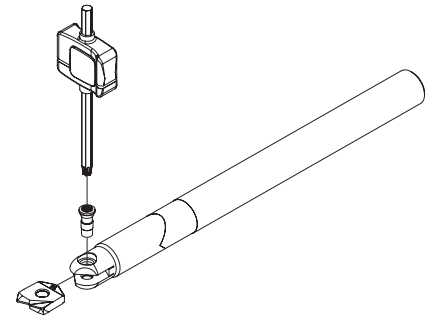

WCR | Inserts | Pastilhas | Plaquetas

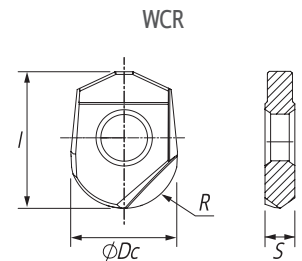

Geometry code	ISO Reference	P		M		K		H		Dimensions Dimensões Dimensiones (mm)			
		PVD		PVD		PVD		PVD		I	R	S	Dc
		X4	X6	X4	X6	X4	X6	X4	X6				
1112900	WCR 08	⊗	⊗	⊗	⊗	⊗	⊗	⊗	⊗	9,7	4,0	2,1	8,0
1111914	WCR 10	⊗	⊗	⊗	⊗	⊗	⊗	⊗	⊗	12,0	5,0	2,7	10,0
1112099	WCR 12	⊗	⊗	⊗	⊗	⊗	⊗	⊗	⊗	14,6	6,0	3,2	12,0
1112100	WCR 16	⊗	⊗	⊗	⊗	⊗	⊗	⊗	⊗	16,6	8,0	4,2	16,0
1112101	WCR 20	⊗	⊗	⊗	⊗	⊗	⊗	⊗	⊗	20,0	10,0	5,2	20,0

⊗ First choice | Primeira opção | 1ª opción
 ⊗ Stock item | Produto de stock | Itens de stock
 ○ Available under request (see page A-9) | Disponível sobre consulta (consulte a página A-9) | Disponible bajo consulta (mire página A-9)
 Insert order code = (1) Geometry Code + (2) Grade Code

WCL | Inserts | Pastilhas | Plaquetas

WCL

NEW

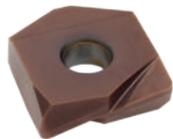

WCL

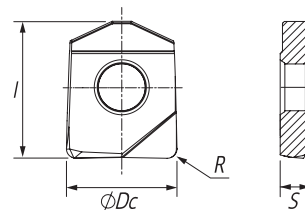

		P		M		K		H		Dimensions Dimensões Dimensiones (mm)			
		PVD		PVD		PVD		PVD		I	R	S	Dc
(1)	(2) Grade code	X4	X6	X4	X6	X4	X6	X4	X6				
Geometry code	ISO Reference	PHH603	PHH910	PHH603	PHH910	PHH603	PHH910	PHH603	PHH910				
1112879	WCL-08 R0.3	⊗	⊗	⊗	⊗	⊗	⊗	⊗	⊗	9,7	0,3	2,1	8
1112880	WCL-08 R0.5	⊗	⊗	⊗	⊗	⊗	⊗	⊗	⊗	9,7	0,5	2,1	08
1112853	WCL-08 R1.0	⊗	⊗	⊗	⊗	⊗	⊗	⊗	⊗	9,7	1,0	2,1	08
1112881	WCL-10 R0.3	⊗	⊗	⊗	⊗	⊗	⊗	⊗	⊗	12,0	0,3	2,7	10
1112882	WCL-10 R0.5	⊗	⊗	⊗	⊗	⊗	⊗	⊗	⊗	12,0	0,5	2,7	10
1112848	WCL-10 R1.0	⊗	⊗	⊗	⊗	⊗	⊗	⊗	⊗	12,0	1,0	2,7	10
1112883	WCL-10 R1.5	⊗	⊗	⊗	⊗	⊗	⊗	⊗	⊗	12,0	1,5	2,7	10
1112884	WCL-10 R2.0	⊗	⊗	⊗	⊗	⊗	⊗	⊗	⊗	12,0	2,0	2,7	10
1112885	WCL-12 R0.3	⊗	⊗	⊗	⊗	⊗	⊗	⊗	⊗	14,6	0,3	3,2	12
1112886	WCL-12 R0.5	⊗	⊗	⊗	⊗	⊗	⊗	⊗	⊗	14,6	0,5	3,2	12
1112096	WCL-12 R1.0	⊗	⊗	⊗	⊗	⊗	⊗	⊗	⊗	14,6	1,0	3,2	12
1112887	WCL-12 R1.5	⊗	⊗	⊗	⊗	⊗	⊗	⊗	⊗	14,6	1,5	3,2	12
1112888	WCL-12 R2.0	⊗	⊗	⊗	⊗	⊗	⊗	⊗	⊗	14,6	2,0	3,2	12
1112889	WCL-12 R3.0	⊗	⊗	⊗	⊗	⊗	⊗	⊗	⊗	14,6	3,0	3,2	12
1112890	WCL-16 R0.3	⊗	⊗	⊗	⊗	⊗	⊗	⊗	⊗	16,6	0,3	4,2	16
1112891	WCL-16 R0.5	⊗	⊗	⊗	⊗	⊗	⊗	⊗	⊗	16,6	0,5	4,2	16
1112097	WCL-16 R1.0	⊗	⊗	⊗	⊗	⊗	⊗	⊗	⊗	16,6	1,0	4,2	16
1112892	WCL-16 R1.5	⊗	⊗	⊗	⊗	⊗	⊗	⊗	⊗	16,6	1,5	4,2	16
1112893	WCL-16 R2.0	⊗	⊗	⊗	⊗	⊗	⊗	⊗	⊗	16,6	2,0	4,2	16
1112894	WCL-16 R3.0	⊗	⊗	⊗	⊗	⊗	⊗	⊗	⊗	16,6	3,0	4,2	16
1112895	WCL-20 R0.3	⊗	⊗	⊗	⊗	⊗	⊗	⊗	⊗	20,0	0,3	5,2	20
1112896	WCL-20 R0.5	⊗	⊗	⊗	⊗	⊗	⊗	⊗	⊗	20,0	0,5	5,2	20
1112098	WCL-20 R1.0	⊗	⊗	⊗	⊗	⊗	⊗	⊗	⊗	20,0	1,0	5,2	20
1112897	WCL-20 R1.5	⊗	⊗	⊗	⊗	⊗	⊗	⊗	⊗	20,0	1,5	5,2	20
1112898	WCL-20 R2.0	⊗	⊗	⊗	⊗	⊗	⊗	⊗	⊗	20,0	2,0	5,2	20
1112899	WCL-20 R3.0	⊗	⊗	⊗	⊗	⊗	⊗	⊗	⊗	20,0	3,0	5,2	20

⊗ First choice | Primeira opção | 1ª opción
 ⊗ Stock item | Produto de stock | Itens de stock
 ⊙ Available under request (see page A-9) | Disponível sobre consulta (consulte a página A-9) | Disponible bajo consulta (mire página A-9)
 Insert order code = (1) Geometry Code + (2) Grade Code

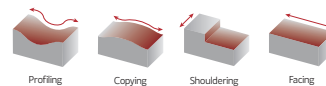

GRADES SELECTION GUIDE | Guia para seleção de graus | Tabla para selección de calidades

ISO	PSM	Material	HB (Brinell)	Grades		
				← Wear Resistance		Toughness →
				PHH603	PHH910	
P	1	Unalloyed Steel	125-220	✓	✓	
	2	Low-Alloyed Steel	220-280	✓	✓	
	3	High-Alloyed Steel	280-380	✓	✓	
M	4	SS - Ferritic / Martensitic	200-330	✓	✓	
	5	SS - Austenitic	200-330	✓	✓	
	6	SS - Austenitic-ferritic (Duplex)	230-260	✓	✓	
K	7	Malleable Cast Iron	130-230	✓	✓	
	8	Grey Cast Iron	180-245	✓	✓	
	9	Nodular Cast iron	160-250	✓	✓	
H	12	Hardened Steels	40-55 HRC	✓	✓	

- Good Conditions
- Average Conditions
- Difficult Conditions

RECOMMENDED CUTTING CONDITIONS | Condições de corte recomendadas | Condiciones de corte recomendables

ISO	PSM	Material	HB (Brinell)	Vc (m/min)		Feed fz (mm/t)		
				← Wear Resistance		Toughness →		
				PHH603	PHH910	WCR	WCL	
P	1	Unalloyed Steel	125-220	180-310	140-270	0,15-0,45	0,10-0,30	
	2	Low-Alloyed Steel	220-280	180-300	140-260	0,15-0,40	0,10-0,25	
	3	High-Alloyed Steel	280-380	180-280	140-220	0,10-0,40	0,10-0,25	
M	4	SS - Ferritic / Martensitic	200-330	170-300	130-260	0,15-0,35	0,10-0,25	
	5	SS - Austenitic	200-330	160-290	120-250	0,15-0,35	0,10-0,25	
	6	SS - Austenitic-ferritic (Duplex)	230-260	150-270	110-230	0,15-0,30	0,08-0,20	
K	7	Malleable Cast Iron	130-230	200-380	180-370	0,10-0,50	0,10-0,35	
	8	Grey Cast Iron	180-245	180-360	180-350	0,10-0,45	0,10-0,30	
	9	Nodular Cast iron	160-250	160-310	160-290	0,10-0,40	0,10-0,30	
H	12	Hardened Steels	46-54 HRC	90-270	80-260	0,05-0,20	0,05-0,15	
	13	Hardened Steels	55-62 HRC	80-200	70-180	0,05-0,15	0,04-0,12	
	14	Hardened Steels	63-70 HRC	70-180	70-160	0,04-0,12	0,04-0,10	

A

MILLING

Overview

Face milling

Hi-feed milling

Shoulder milling

Profile milling

Hardmill

Center & Chamfer

Spot face

Spare Parts

Technical Data

End Mills

BALLPRO 93090

NEW

BALLPRO 63090

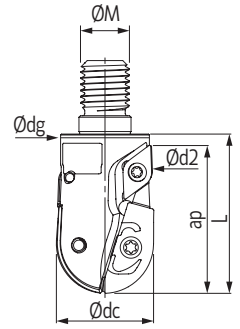

Threaded Coupling

Order code Código	Reference Referência Referencia		Dimensions Dimensões Dimensiones (mm)					Specifications Ap max (mm)	Kg	Insert	Insert 2	Stock
			ØDc	ØDc2	Ød/M	Ødg	L					
181125000	032R63090-02-M16052	2	32	31,9	M16	29	52	48	0,168	XPGT 3206	DCMW 11T3	

Stock item | Produto de stock | Itens de stock

Available under request (see page A-8) | Disponível sobre consulta (consulte a página A-8) | Disponible bajo consulta (mire pagina A-8)

XPGT 3206

XPGT

NEW

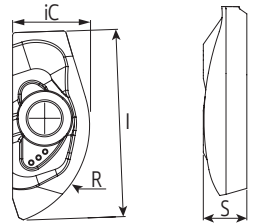

(1) Geometry code	(2) Grade code	P					M					K					S					Dimensions (mm)			
		G4	G6	G6	G4	G6	PH7920	PH7740	PH7740	PH7920	PH7740	PH7920	PH7740	PH7920	PH7740	PH7920	PH7740	iC	S	I	R				
1112485	XPGT 3206-MP																	12,576	7	30,6	16				

First choice | Primeira opção | 1ª opción

Stock item | Produto de stock | Itens de stock

Available under request (see page A-9) | Disponível sobre consulta (consulte a página A-9) | Disponible bajo consulta (mire pagina A-9)

Insert order code = (1) Geometry Code + (2) Grade Code

DCMW 11T3

DCMW

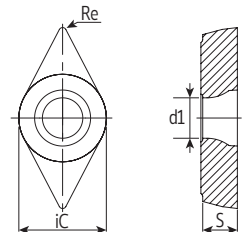
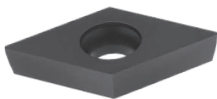

(1) Geometry code	(2) Grade code	L5	Dimensions (mm)			
			iC	S	Re	d1
1120305	DCMW 11T304		9,525	3,97	0,4	4,4

First choice | Primeira opção | 1ª opción

Stock item | Produto de stock | Itens de stock

Available under request (see page A-9) | Disponível sobre consulta (consulte a página A-9) | Disponible bajo consulta (mire pagina A-9)

Insert order code = (1) Geometry Code + (2) Grade Code



GRADES SELECTION GUIDE || Guia para selecção de graus | Tabla para selección de calidades

ISO	PSM	Material	HB (Brinell)	Grades		
				← Wear Resistance		Toughness →
				PH7920	PH7740	
P	1	Unalloyed Steel	125-220	✓	✓	
	2	Low-Alloyed Steel	220-280	✓	✓	
	3	High-Alloyed Steel	280-380	✓	✓	
M	4	SS - Ferritic / Martensitic	200-330		✓	
	5	SS - Austenitic	200-330		✓	
	6	SS - Austenitic-ferritic (Duplex)	230-260		✓	
K	7	Malleable Cast Iron	130-230	✓		
	8	Grey Cast Iron	180-245	✓		
	9	Nodular Cast iron	160-250	✓		
S	11	Heat Resistant Super Alloys	200-320		✓	

RECOMMENDED CUTTING CONDITIONS || Condições de corte recomendadas | Condiciones de corte recomendadas

ISO	PSM	Material	HB (Brinell)	Vc (m/min)		Feed fz (mm/t)	
				← Wear Resistance			Toughness →
				PH7920	PH7740		
P	1	Unalloyed Steel	125-220	190-350	140-300	0,10-0,90	
	2	Low-Alloyed Steel	220-280	180-280	130-230	0,10-0,85	
	3	High-Alloyed Steel	280-380	150-220	100-180	0,05-0,80	
M	4	SS - Ferritic / Martensitic	200-330	-	120-260	0,05-0,80	
	5	SS - Austenitic	200-330	-	100-200	0,05-0,80	
	6	SS - Austenitic-ferritic (Duplex)	230-260	-	60-120	0,05-0,60	
K	7	Malleable Cast Iron	130-230	240-380	-	0,15-0,90	
	8	Grey Cast Iron	180-245	220-320	-	0,15-0,90	
	9	Nodular Cast iron	160-250	180-280	-	0,10-0,80	
S	11	Heat Resistant Super Alloys	200-320	-	30-110	0,10-0,80	

SPARE PARTS || Complementos | Repuestos

Insert	Insert Screw	Key (Torx)	Key (Torx - Nm)	Torque Value
XPGT	P0501302	PT20	DT2050	5.0 Nm
DCMW	P0400900	XT15	DT1530	3.0 Nm

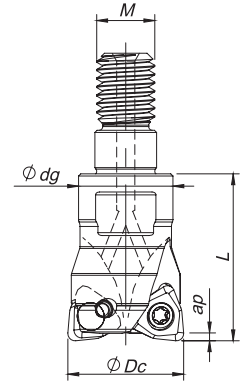

Threaded Coupling

$\kappa_r = 95^\circ$ | $\gamma_p = -7^\circ$

Order code Código	Reference Referência Referencia		Dimensions Dimensões Dimensiones (mm)				Kg	Specifications	Insert Pastilha Inserto	Stock
			$\varnothing Dc$	M	$\varnothing dg$	L		Ap max (mm)		
181030400	016R49095-02-07-M08023	2	16	M8	13	23	0,024	0,30	WNHU 04T310	
181028600	020R49095-03-07-M10028	3	20	M10	18	28	0,052	0,30	WNHU 04T310	
181030500	025R49095-04-07-M12030	4	25	M12	21	30	0,082	0,30	WNHU 04T310	
181030600	035R49095-05-07-M16035	5	35	M16	29	35	0,190	0,30	WNHU 04T310	

Stock item | Produto de stock | Itens de stock

Available under request (see page A-8) | Disponível sobre consulta (consulte a página A-8) | Disponible bajo consulta (mire pagina A-8)

WNHU 04T310 | Inserts | Pastilhas | Plaquetas

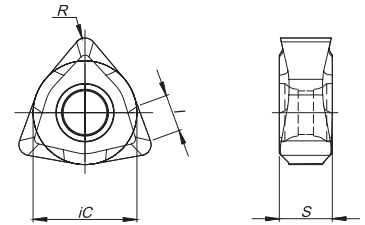

		P		K		H		Dimensions Dimensões Dimensiones (mm)			
		PVD		PVD		PVD		iC	S	I	R
⁽¹⁾ Geometry code	⁽²⁾ Grade code	X5	G4	X5	G4	X4	X5				
1110783	WNHU 04T310							6,35	3,50	2,80	1,00

First choice | Primeira opção | 1ª opción Stock item | Produto de stock | Itens de stock

Available under request (see page A-9) | Disponível sobre consulta (consulte a página A-9) | Disponible bajo consulta (mire pagina A-9)

Insert order code = (1) Geometry Code + (2) Grade Code

SPARE PARTS | Complementos | Repuestos

Cutter $\varnothing Dc$	Order separately			
	Insert Screw	Key (Torx)	Key (Torx - Nm)	Torque Value
R49095 - 16-35	 P0250704	 XT08	 DT0812	 1,2

Note: The toolholder is supplied with the XT/PT key. To order the DT key please check the page A-241.
Check the procedures for the clamping screws on the page A-241.

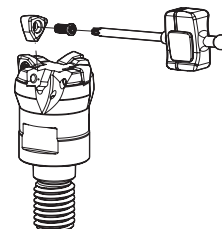



GRADES SELECTION GUIDE | Guia para selecção de graus | Tabla para selección de calidades

ISO	PSM	Material	HB (Brinell)	Grades		
				← Wear Resistance		Toughness →
				PHH603	PHP910	PH7920
P	1	Unalloyed Steel	125-220	●	✓	✓
	2	Low-Alloyed Steel	220-280		✓	✓
	3	High-Alloyed Steel	280-380	✓	✓	✓
K	7	Malleable Cast Iron	130-230		✓	✓
	8	Grey Cast Iron	180-245		✓	✓
	9	Nodular Cast iron	160-250		✓	✓
H	12	Hardened Steels	40-55 HRC	✓		

- Good conditions
- Average Conditions
- Difficult Conditions

(Note 1) Grade PHH603 must be used only on finishing operations.

RECOMMENDED CUTTING CONDITIONS | Condições de corte recomendadas | Condiciones de corte recomendables

ISO	PSM	Material	HB (Brinell)	Vc (m/min)		
				← Wear Resistance		Toughness →
				PHH603	PHP910	PH7920
P	1	Unalloyed Steel	125-220	-	180-250	180-240
	2	Low-Alloyed Steel	220-280	-	160-240	160-220
	3	High-Alloyed Steel	280-380	180-310	140-230	140-210
K	7	Malleable Cast Iron	130-230	-	180-300	160-260
	8	Grey Cast Iron	180-245	-	160-250	140-240
	9	Nodular Cast iron	160-250	-	150-210	120-200
H	12	Hardened Steels	40-55 HRC	70-270	-	-

(Note 1) Grade PHH603 must be used only on finishing operations.

Insert	Feed f_z (mm/t)		a_p Rec.
	Roughing	Finishing	
WNHU 04T310	0.15-0.25	0.10-0.20	0.10-0.50

(Note 1) Cutting conditions should be adjusted according to the machine and work rigidity.

(Note 2) If chattering occurs, reduce a_p and V_c by 30% and keep the same f_z per tooth.

A

MILLING

Overview

Face milling

Hifeed milling

Shoulder milling

Profile milling

Hardmill

Center & Chamfer

Spot face

Spare Parts

Technical Data

End Mills

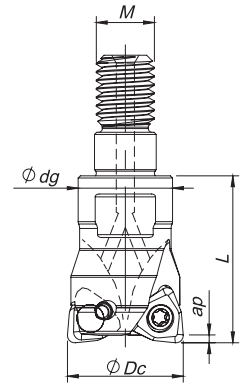

Threaded Coupling

$K_r = 95^\circ$ | $\gamma_p = -6^\circ$

Order code Código	Reference Referência Referencia		Dimensions Dimensões Dimensiones (mm)				Kg	Specifications	Insert Pastilha Inserto	Stock
			ϕDc	M	ϕdg	L		A_p max (mm)		
181037500	025R45095-02-06-M12030	2	25	M12	21	30	0,079	0,50	WNHU 060410	
181037600	035R45095-03-06-M16035	3	35	M16	29	35	0,185	0,50	WNHU 060410	
181037700	042R45095-04-06-M16035	4	42	M16	29	35	0,219	0,50	WNHU 060410	

Stock item | Produto de stock | Itens de stock

Available under request (see page A-8) | Disponível sobre consulta (consulte a página A-8) | Disponible bajo consulta (mire pagina A-8)

WNHU 060410 | Inserts | Pastilhas | Plaquitas

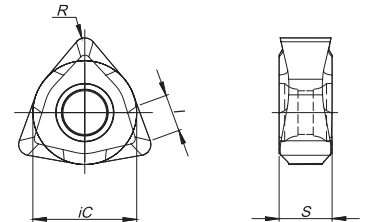
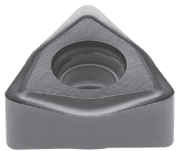

	⁽²⁾ Grade code	P	K	H		Dimensions Dimensões Dimensiones (mm)			
		PVD	PVD	PVD		iC	S	I	R
⁽¹⁾ Geometry code	ISO Reference	PHP910	PHP910	PHH603	PHP910				
1111424	WNHU 060410					9,53	4,76	3,40	1,00

First choice | Primeira opção | 1ª opción

Stock item | Produto de stock | Itens de stock

Available under request (see page A-9) | Disponível sobre consulta (consulte a página A-9) | Disponible bajo consulta (mire pagina A-9)

Insert order code = (1) Geometry Code + (2) Grade Code

SPARE PARTS | Complementos | Repuestos

Cutter ϕDc	Order separately			
	Insert Screw	Key (Torx)	Key (Torx - Nm)	Torque Value
R45095 - 25-42	P0350902	XT10	DT1020	2,0

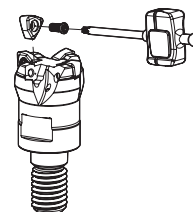

Note: The toolholder is supplied with the XT/PT key. To order the DT key please check the page A-241.
Check the procedures for the clamping screws on the page A-241.



GRADES SELECTION GUIDE | Guia para selecção de graus | Tabla para selección de calidades

ISO	PSM	Material	HB (Brinell)	Grades		
				← Wear Resistance		Toughness →
				PHH603	PHP910	
P	1	Unalloyed Steel	125-220	●	✓	
	2	Low-Alloyed Steel	220-280	●	✓	
	3	High-Alloyed Steel	280-380	✓	✓	
K	7	Malleable Cast Iron	130-230	●	✓	
	8	Grey Cast Iron	180-245	●	✓	
	9	Nodular Cast iron	160-250	●	✓	
H	12	Hardened Steels	40-55 HRC	✓	✓	

- Good Conditions
- Average Conditions
- Difficult Conditions

(Note 1) Grade PHH603 must be used only on finishing operations.

RECOMMENDED CUTTING CONDITIONS | Condições de corte recomendadas | Condiciones de corte recomendables

ISO	PSM	Material	HB (Brinell)	Vc (m/min)		
				← Wear Resistance		Toughness →
				PHH603	PHP910	
P	1	Unalloyed Steel	125-220	-	180-250	
	2	Low-Alloyed Steel	220-280	-	160-240	
	3	High-Alloyed Steel	280-380	180-310	140-230	
K	7	Malleable Cast Iron	130-230	-	180-300	
	8	Grey Cast Iron	180-245	-	160-250	
	9	Nodular Cast iron	160-250	-	150-210	
H	12	Hardened Steels	40-55 HRC	70-270	60-250	

(Note 1) Grade PHH603 must be used only on finishing operations.

Insert	Feed f_z (mm/t)		a_p Rec.
	Roughing	Finishing	
WNHU 060410	0.15-0.30	0.10-0.25	0.10-0.50

(Note 1) Cutting conditions should be adjusted according to the machine and work rigidity.
(Note 2) If chattering occurs, reduce a_p and V_c by 30% and keep the same f_z per tooth.

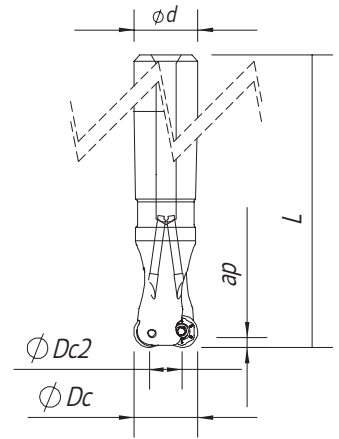

Cylindrical Shank

$\gamma_p = +5^\circ$

Order code Código	Reference Referência Referencia		Dimensions Dimensões Dimensiones (mm)					Kg	Specifications	Insert Pastilha Inserto	Stock
			ϕDc	$\phi Dc2$	ϕd	L	L1		Ap max (mm)		
33590											
181122500	016E33590-02-04-016160	2	16	8	16	160	59	0,23	4,0	RD...0802 MOE	
181122600	020E33590-03-05-020180	3	20	12	20	180	59	0,36	4,0	RD...0802 MOE	
181122700	025E33590-04-05-025200	4	25	17	25	200	59	0,65	4,0	RD...0802 MOE	
33690											
181123400	020E33690-02-05-020180	2	20	10	20	180	50	0,40	5,0	RP...10T3 MOE	
181123500	025E33690-03-05-025200	3	25	15	25	200	60	0,76	5,0	RP...10T3 MOE	
181123600	032E33690-04-05-032200	4	32	22	32	200	60	0,98	5,0	RP...10T3 MOE	

Stock item | Produto de stock | Itens de stock

Available under request (see page A-8) | Disponível sobre consulta (consulte a página A-8) | Disponible bajo consulta (mire pagina A-8)

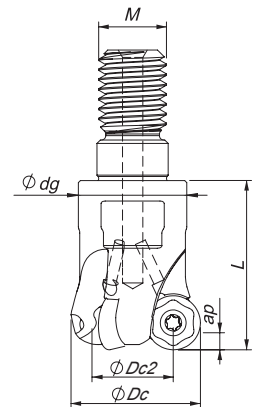

Threaded Coupling

$\gamma_p = +5^\circ$

Order code Código	Reference Referência Referencia		Dimensions Dimensões Dimensiones (mm)					Kg	Specifications	Insert Pastilha Inserto	Stock
			ϕDc	$\phi Dc2$	ϕM	ϕdg	L		Ap max (mm)		
33590											
181098600	016R33590-02-04-M08020	2	16	8	M8	13	20	0,03	4,0	RD...0802 MOE	
181122800	020R33590-03-05-M10025	3	20	12	M10	16	25	0,07	4,0	RD...0802 MOE	
181122900	025R33590-04-05-M12030	4	25	17	M12	21	30	0,14	4,0	RD...0802 MOE	
181123000	032R33590-05-05-M16043	5	32	24	M16	29	43	0,25	4,0	RD...0802 MOE	
33690											
181110600	020R33690-02-05-M10032	2	20	10	M10	16	32	0,10	5,0	RP...10T3 MOE	
181110700	025R33690-03-05-M12035	3	25	15	M12	21	35	0,19	5,0	RP...10T3 MOE	
181110800	032R33690-04-05-M16035	4	32	22	M16	29	35	0,31	5,0	RP...10T3 MOE	
181120700	035R33690-05-05-M16045	5	35	25	M16	29	45	0,40	5,0	RP...10T3 MOE	

Available under request (see page A-8) | Disponível sobre consulta (consulte a página A-8) | Disponible bajo consulta (mire pagina A-8)

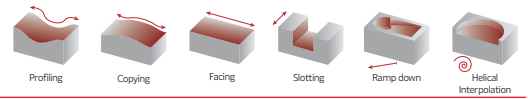

Arbor Mounting

$\gamma_p = +5^\circ$

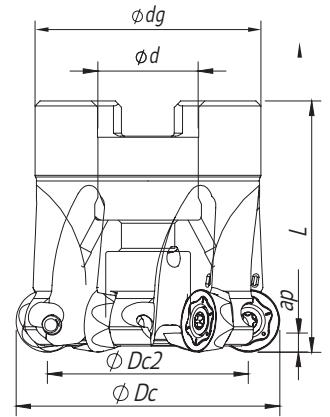

Order code Código	Reference Referência Referencia		Dimensions Dimensões Dimensiones (mm)					Kg	Specifications		Insert Pastilha Inserto	Stock
			ϕDc	$\phi Dc2$	$\phi d/M$	ϕdg	L		Arbor Type	Ap max (mm)		
33690												
181123700	042A33690-06-05-016040	6	42	32	16	36	40	0,16	A	5,0	RP...10T3 MOE	
181123800	050A33690-06-05-022040	6	50	40	22	42	40	0,26	A	5,0	RP...10T3 MOE	
181123900	052A33690-07-05-022040	7	52	42	22	42	40	0,30	A	5,0	RP...10T3 MOE	
33790												
181098700	040A33790-04-05-016040	4	40	28	26	36	40	0,15	A	6,0	RP...1204 MOE	
181111500	050A33790-04-05-022040	4	50	38	22	42	40	0,20	A	6,0	RP...1204 MOE	
181124200	052A33790-05-05-022040	5	52	40	22	42	40	0,25	A	6,0	RP...1204 MOE	
181122100	063A33790-06-05-022040	6	63	51	22	48	40	0,36	A	6,0	RP...1204 MOE	
181124300	066A33790-06-05-027050	6	66	54	27	48	50	0,40	A	6,0	RP...1204 MOE	
181124400	080A33790-07-05-027050	7	80	68	27	60	50	0,68	A	6,0	RP...1204 MOE	

Stock item | Produto de stock | Itens de stock

Available under request (see page A-8) | Disponível sobre consulta (consulte a página A-8) | Disponible bajo consulta (mire página A-8)

TOROMILL 33590 | 33690 | 33790 | 33890 | 33990

Proprietary milling line



Arbor Mounting

$$\gamma_p = 5^\circ$$

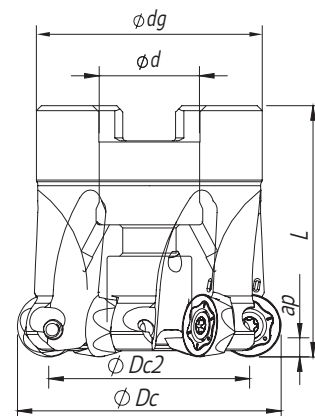

Order code Código	Reference Referência Referencia		Dimensions Dimensões Dimensiones (mm)					Kg	Specifications		Insert Pastilha Inserto	Stock
			ϕDc	$\phi Dc2$	ϕd	ϕdg	L		Arbor Type	Ap max (mm)		
33890												
181124500	050A33890-04-05-022040	4	50	34	22	42	40	0,21	A	8,0	RP...1605 MOE	○
181124600	052A33890-04-05-022040	4	52	36	22	42	40	0,25	A	8,0	RP...1605 MOE	○
181114900	063A33890-05-05-022040	5	63	47	22	48	40	0,37	A	8,0	RP...1605 MOE	⊗
181124700	066A33890-05-05-027050	5	66	54	27	48	50	0,46	A	8,0	RP...1605 MOE	⊗
181124800	080A33890-06-05-027052	6	80	64	27	60	52	0,85	A	8,0	RP...1605 MOE	⊗
181124900	100A33890-07-05-032052	7	100	84	32	80	52	1,57	A	8,0	RP...1605 MOE	⊗
181122200	125A33890-08-05-040052	8	125	109	40	90	52	2,12	A	8,0	RP...1605 MOE	⊗
33990												
181112200	080A33990-05-05-027050	5	80	60	27	60	50	0,73	A	10,0	RP...2006 MOE	⊗
181099800	100A33990-06-05-032063	6	100	80	32	80	63	1,62	A	10,0	RP...2006 MOE	⊗
181099900	125A33990-06-05-040063	6	125	105	40	90	63	2,53	A	10,0	RP...2006 MOE	⊗

⊗ Stock item | Produto de stock | Itens de stock

○ Available under request (see page A-8) | Disponível sobre consulta (consulte a página A-8) | Disponible bajo consulta (mire pagina A-8)

RDHT | RPHT | Inserts | Pastilhas | Plaquetas

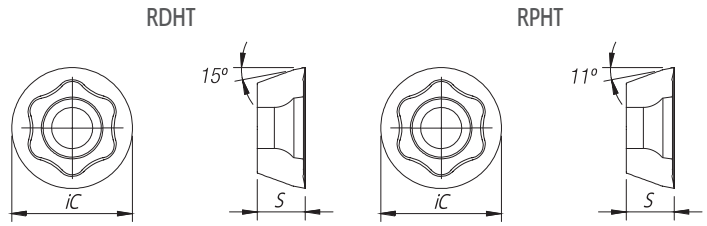
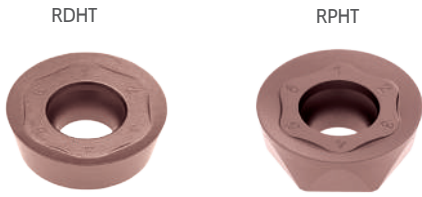

(1) Geometry code	(2) Grade code ISO Reference	P				M				S			Dimensions Dimensões Dimensiones (mm)	
		CVD	PVD			PVD				PVD				
		T9	T1	Z1	Z2	X9	Y2	Z2	Z3	X9	Y2	Z3	iC	S
1112152	RDHT 0802 M0E-LS				⊗			⊗	⊗			⊗	8,00	2,38
1112253	RPHT 10T3 M0E-MS		⊗			⊗				⊗			10,00	3,97
1112772	RPHT 10T3 M0E-LS	⊗		⊗	⊗		⊗	⊗	⊗		⊗	⊗	10,00	3,97
1112186	RPHT 1204 M0E-MS		⊗			⊗				⊗			12,00	4,76
1112766	RPHT 1204 M0E-LS	⊗		⊗	⊗		⊗	⊗	⊗		⊗	⊗	12,00	4,76
1112254	RPHT 1605 M0E-MS		⊗			⊗				⊗			16,00	5,56
1112951	RPHT 1605 M0E-LS			⊗	⊗		⊗	⊗	⊗		⊗	⊗	16,00	5,56
1112958	RPHT 2006 M0E-LS				⊗		⊗	⊗	⊗		⊗	⊗	20,00	6,35

⊗ First choice | Primeira opção | 1ª opción ⊗ Stock item | Produto de stock | Itens de stock ○ Available under request (see page A-9) | Disponível sobre consulta (consulte a página A-9) | Disponible bajo consulta (mire página A-9) Insert order code = (1) Geometry Code + (2) Grade Code

TURBOMILL 34190

NEW

Proprietary milling line

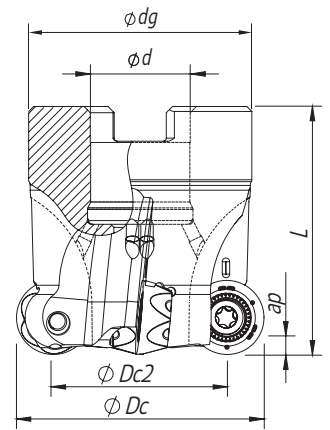

Arbor Mounting

$$\gamma_p = 5^\circ$$

Order code Código	Reference Referência Referencia		Dimensions Dimensões Dimensiones (mm)					Kg	Specifications		Insert	Stock
			ϕDc	$\phi Dc2$	ϕd	ϕdg	L		Arbor Type	A_p max (mm)		
181160100	042A34190-06-05-016040	6	42	32	16	36	40	0,16	A	5	RPHT 10T3M0E-LS(4)	
181160200	050A34190-06-05-022039	6	50	40	22	42	40	0,26	A	5	RPHT 10T3M0E-LS(4)	
181160700	052 A34190-07-05-022040	7	52	42	22	42	40	0,30	A	5	RPHT 10T3M0E-LS(4)	

Stock item | Produto de stock | Itens de stock

Available under request (see page A-8) | Disponível sobre consulta (consulte a página A-8) | Disponible bajo consulta (mire página A-8)

TURBOMILL 34290

NEW

Proprietary milling line

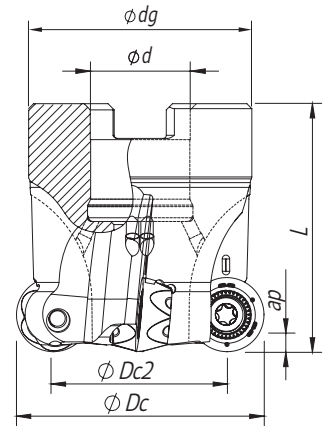

Arbor Mounting

$$\gamma_p = 5^\circ$$

Order code Código	Reference Referência Referencia		Dimensions Dimensões Dimensiones (mm)					Kg	Specifications		Insert	Stock
			ϕDc	$\phi Dc2$	ϕd	ϕdg	L		Arbor Type	A_p max (mm)		
181159600	040A34290-04-05-016040	4	40	28	16	36	40	0,15	A	6	RPHT 1204 M0E-LS(4)	
181159500	052A34290-05-05-022040	5	52	40	22	42	40	0,25	A	6	RPHT 1204 M0E-LS(4)	
181160400	063A34290-06-05-022040	6	63	51	22	48	40	0,36	A	6	RPHT 1204 M0E-LS(4)	
181160500	066A34290-06-05-027050	6	66	54	27	48	50	0,40	A	6	RPHT 1204 M0E-LS(4)	
181160600	080A34290-07-05-027050	7	80	68	27	60	50	0,68	A	6	RPHT 1204 M0E-LS(4)	

Stock item | Produto de stock | Itens de stock

Available under request (see page A-8) | Disponível sobre consulta (consulte a página A-8) | Disponible bajo consulta (mire página A-8)

SPARE PARTS | Complementos | Repuestos

Cutter ØDc	Insert Screw	Key (Torx)	Order separately	
			Key (Torx - Nm)	Torque Value
33590	P0250503	XT08	DT0812	1,20
33690	P0300800	XT09	DT0914	1,40
33790	P0350800	XT15	DT1530	3,00
33890	P0451100	XT20	DT2050	5,00
33990	P0501302	PT20	DT2050	5,00

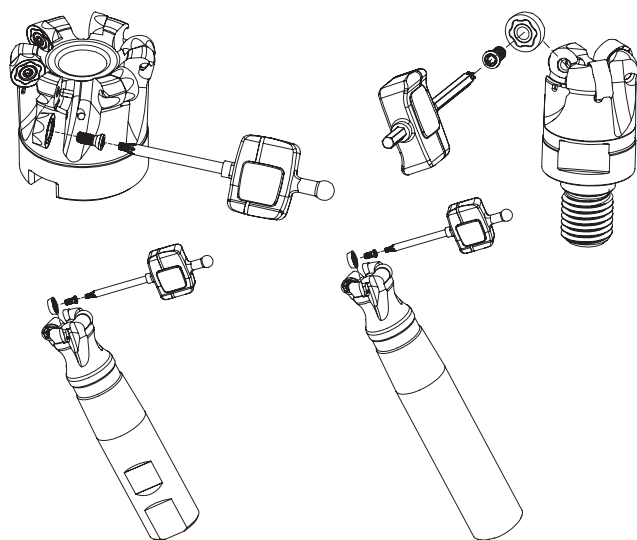

Note: The toolholder is supplied with the XT/PT key. To order the DT key please check the page A-241.
Check the procedures for the clamping screws on the page A-241.

RPHT-LS | Inserts | Pastilhas | Plaquitas

RPHT-LS4

NEW



RPHT-LS

NEW



RPHT-LS | LS4

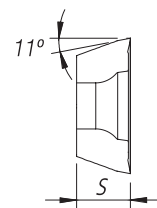
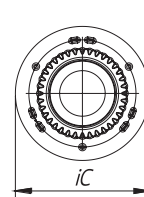

Geometry code	ISO Reference	P			M			S		Dimensions Dimensões Dimensiones (mm)	
		CVD	PVD		PVD			PVD			
(1)	(2) Grade code	T9	Z1	Z2	Y2	Z2	Z3	Y2	Z3	iC	S
1112772	RPHT 10T3M0E-LS	⊗	⊗	⊗	⊗	⊗	⊗	⊗	⊗	10,00	3,97
1113021	RPHT 10T3 M0E-LS4			⊗		⊗	⊗		⊗	12,00	4,76
1112766	RPHT 1204 M0E-LS	⊗	⊗	⊗	⊗	⊗	⊗	⊗	⊗	10,00	3,97
1113020	RPHT 1204 M0E-LS4			⊗		⊗	⊗		⊗	12,00	4,76

⊗ First choice | Primeira opção | 1ª opción ⊗ Stock item | Produto de stock | Itens de stock

○ Available under request (see page A-9) | Disponível sobre consulta (consulte a página A-9) | Disponible bajo consulta (mire página A-9)

Insert order code = (1) Geometry Code + (2) Grade Code

GRADES SELECTION GUIDE | Guia para selecção de graus | Tabla para selección de calidades

ISO	PSM	Material	HB (Brinell)	Grades						
				← Wear Resistance				Toughness →		
				PHP920	PHH930	PHP530	PHH530	PHP808	PHH808	PHS740
P	1	Unalloyed Steel	125-220	✓		✓		✓		✓
	2	Low-Alloyed Steel	220-280	✓		✓		✓		✓
	3	High-Alloyed Steel	280-380	✓		✓		✓		✓
M	4	SS - Ferritic / Martensitic	200-330		✓	✓	✓		✓	
	5	SS - Austenitic	200-330		✓		✓		✓	
	6	SS - Austenitic-ferritic (Duplex)	230-260		✓		✓		✓	
S	11	Heat Resistant Super Alloys	200-320		✓		✓		✓	

Good Conditions
 Average Conditions
 Difficult Conditions

RECOMMENDED CUTTING CONDITIONS | Condições de corte recomendadas | Condiciones de corte recomendables

ISO	PSM	Material	HB (Brinell)	Vc (m/min)						
				← Wear Resistance				Toughness →		
				PHP920	PHH930	PHP530	PHH530	PHP808	PHH808	PHS740
P	1	Unalloyed Steel	125-220	180-250	-	180-340	-	180-340	-	180-350
	2	Low-Alloyed Steel	220-280	160-230	-	180-340	-	180-340	-	180-340
	3	High-Alloyed Steel	280-380	140-220	-	180-330	-	180-330	-	180-340
M	4	SS - Ferritic / Martensitic	200-330	-	140-210	150-270	170-280	-	160-270	-
	5	SS - Austenitic	200-330	-	120-170	-	160-280	-	160-270	-
	6	SS - Austenitic-ferritic (Duplex)	230-260	-	100-150	-	150-260	-	150-250	-
S	11	Heat Resistant Super Alloys	200-320	-	30-110	-	30-150	-	30-140	-

ISO	PSM	Material	HB (Brinell)	Feed fz (mm/t)				
				RDHT 08..	RPHT 10...	RPHT 12...	RPHT 16...	RPHT 20...
				P	1	Unalloyed Steel	125-220	0,05-0,35
2	Low-Alloyed Steel	220-280	0,05-0,35		0,05-0,40	0,05-0,45	0,08-0,55	0,10-0,55
3	High-Alloyed Steel	280-380	0,05-0,30		0,05-0,35	0,05-0,40	0,08-0,50	0,10-0,55
M	4	SS - Ferritic / Martensitic	200-330	0,05-0,25	0,05-0,30	0,05-0,35	0,08-0,45	0,10-0,50
	5	SS - Austenitic	200-330	0,05-0,25	0,05-0,30	0,05-0,35	0,08-0,45	0,10-0,50
	6	SS - Austenitic-ferritic (Duplex)	230-260	0,05-0,25	0,05-0,30	0,05-0,35	0,08-0,45	0,10-0,45
S	11	Heat Resistant Super Alloys	200-320	0,05-0,20	0,05-0,25	0,05-0,30	0,08-0,35	0,10-0,40

(Note 1) Cutting conditions $a_e/D_c=70\%$.

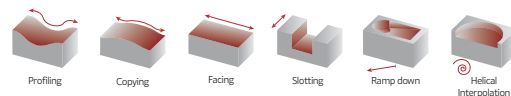

INSERT INFORMATION | Informação de pastilha | Información del inserto

RPHT-LS

RPHT-LS

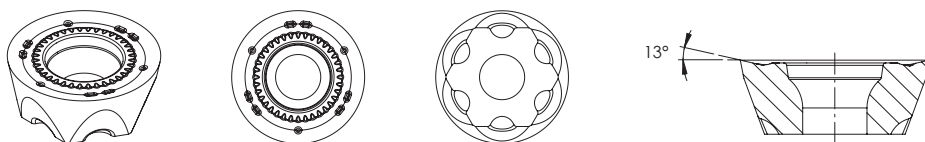

6 cutting edges insert

- Insert with 6 cutting edges for a higher productivity.

Insert Geometry

- Improved geometry for low cutting force;
- Positive insert with a brand new edge positioning system.

The maximum depth of cut using 6 cutting edges (LS)

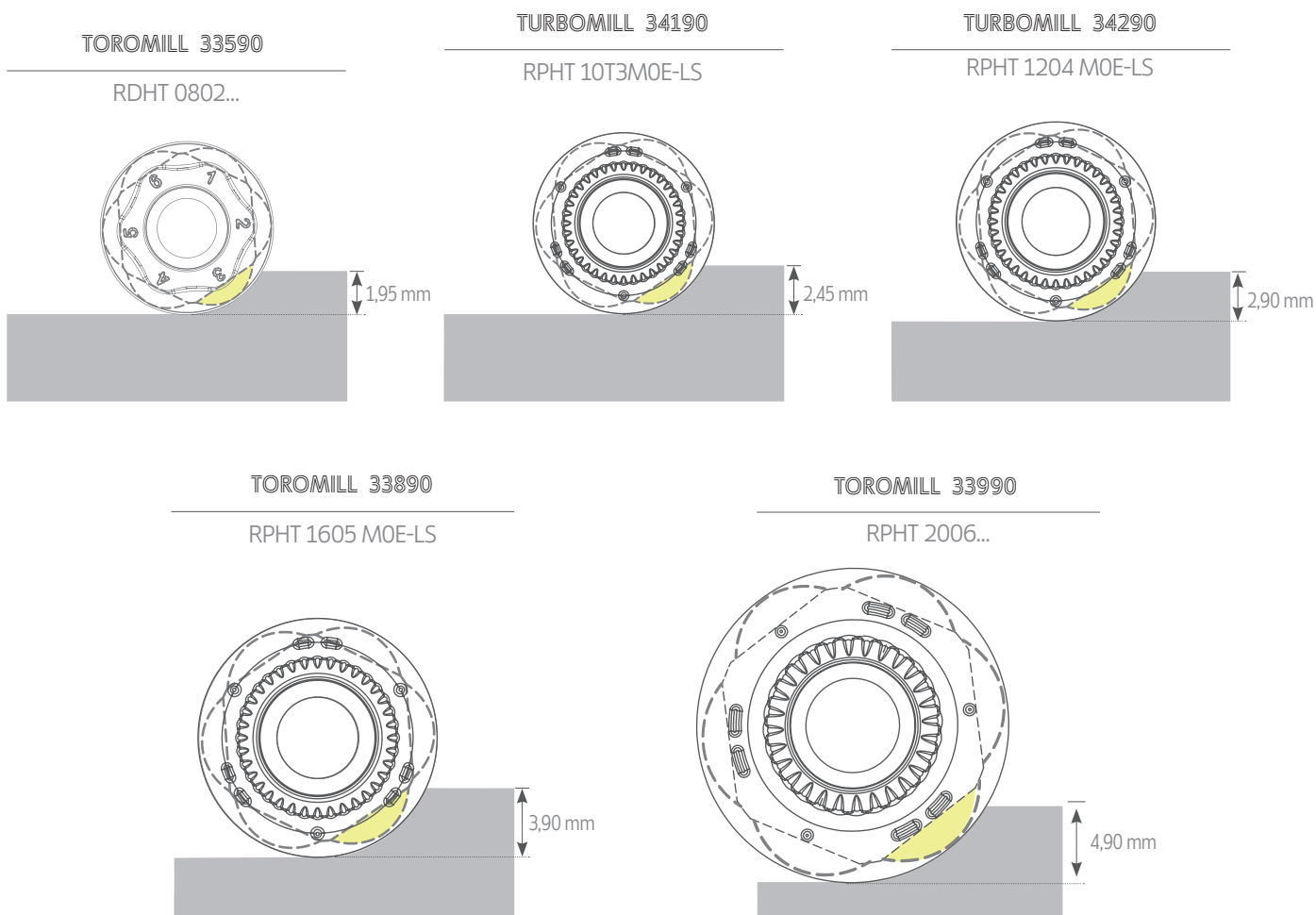

RPHT-LS4

RPHT-LS4

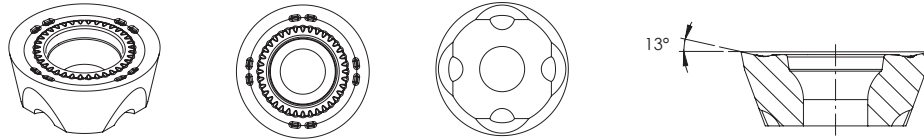

4 cutting edges insert

- Insert with 4 cutting edges for higher depth of cut.

Insert Geometry

- Improved geometry for low cutting force;
- Positive insert with a brand new edge positioning system.

The maximum depth of cut using 4 cutting edges

TURBOMILL 34190

TURBOMILL 34290

RPHT 10T3M0E-LS4

RPHT 1204 M0E-LS4

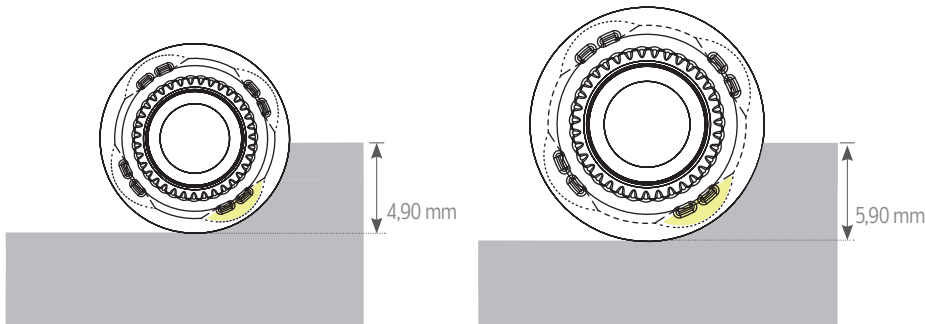

GEOMETRY FEATURES | Características geométricas | Características geométricas

Geometry	Features Características Características
Geometry LS General machining	Optimized geometry for stainless steel and HRSA. Suitable for alloy steel machining.
Geometry LS4 General machining	Optimized geometry for stainless steel and HRSA. Suitable for alloy steel machining. 4 Cutting edges version.

RAMPING AND HELICAL INTERPOLATION

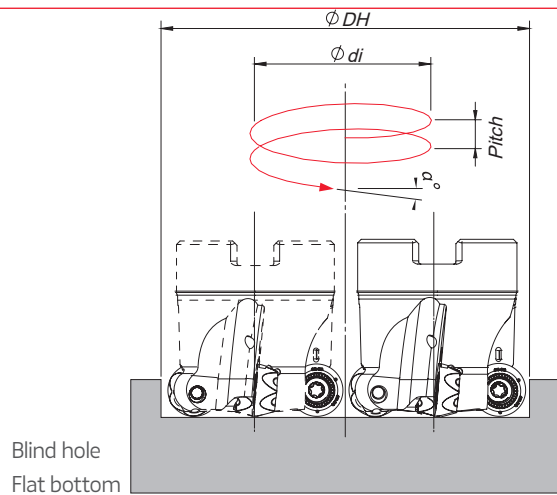
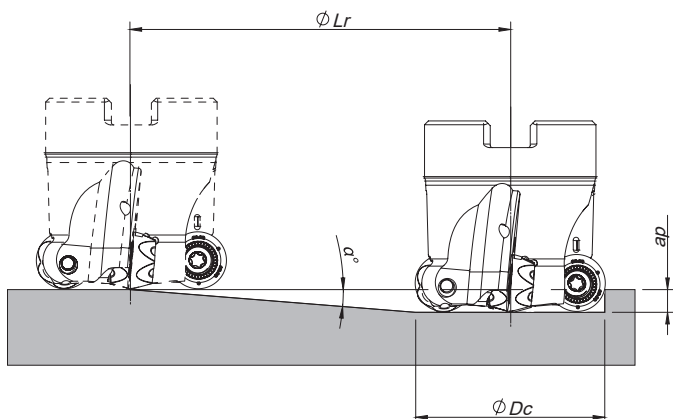

$$\varnothing di = \varnothing DH - \varnothing Dc$$

Insert	$\varnothing Dc$	Ramping			Helical Interpolation		
		Max Ramp α°	Max ap	Min Lr	$\varnothing DH_{min}$	$\varnothing DH_{max}$	Max Pitch/Rev.
33590							
RD... 08	16	10,0	4,0	22,7	24	-	4
	20	8,0	4,0	28,5	32	32	8
	25	10,0	4,0	22,7	42	40	5
	32	8,0	4,0	28,5	56	50	8
33690 34190							
RP... 10	20	7,0	5,0	40,7	30	-	3
	25	6,0	5,0	47,6	40	40	7
	32	6,0	5,0	47,6	54	50	8
	35	5,0	5,0	57,2	60	64	7
	42	5,0	5,0	57,2	74	70	6
	50	4,0	5,0	71,5	90	84	9
	52	3,0	5,0	95,4	94	100	8
34290							
RP... 12	40	8,0	6,0	42,7	68	-	12
	50	3,5	6,0	98,1	88	80	17
	52	3,0	6,0	114,5	92	100	7
	63	2,5	6,0	137,4	114	104	9
	66	2,5	6,0	137,4	120	126	6
	80	2,0	6,0	171,8	148	132	8
33890							
RP... 16	50	7,0	8,0	65,2	84	-	13
	52	7,0	8,0	65,2	88	100	19
	63	7,0	8,0	65,2	110	104	13
	66	3,0	8,0	152,6	116	126	20
	80	3,0	8,0	152,6	144	-	18
	100	3,0	8,0	152,6	184	132	24
	125	2,5	8,0	183,2	234	200	8
33990							
RP... 20	80	4,0	10,0	143,0	140	-	13
	100	3,0	10,0	190,8	180	160	17
	125	2,5	10,0	229,0	230	200	13
							16
							14
							17

Note: During helical interpolation do not exceed max Pitch.



Arbor Mounting

$\gamma_p = -7^\circ$

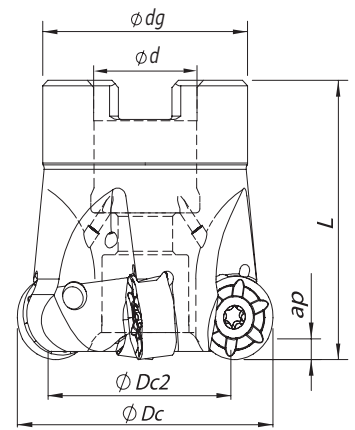

Order code Código	Reference Referência Referencia		Dimensions Dimensões Dimensiones (mm)					Kg	Specifications		Insert Pastilha Inserto	Stock
			ϕDc	$\phi Dc2$	ϕd	ϕdg	L		Arbor Type	Ap max (mm)		
181111600	040A35190-04-07-016040	4	40	32	16	32	40	0,20	A	3,0	RNHX 1204 MOE...	
181100200	050A35190-05-07-022040	5	50	42	22	40	40	0,24	A	3,0	RNHX 1204 MOE...	
181128800	063A35190-06-07-022050	6	63	49	22	48	50	0,55	A	3,0	RNHX 1204 MOE...	
181128900	080A35190-07-07-027050	7	80	60	27	60	50	0,78	A	3,0	RNHX 1204 MOE...	
181175600	100A35190-09-07-032050	9	100	80	32	70	50	1,00	B	3,0	RNHX 1204 MOE...	

Stock item | Produto de stock | Itens de stock

Available under request (see page A-8) | Disponível sobre consulta (consulte a página A-8) | Disponible bajo consulta (mire pagina A-8)



Threaded Coupling

$\gamma_p = -7^\circ$

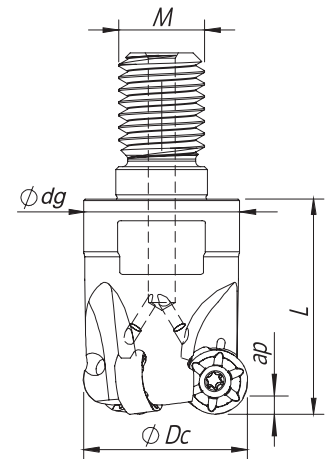

Order code Código	Reference Referência Referencia		Dimensions Dimensões Dimensiones (mm)				Kg	Specifications		Insert Pastilha Inserto	Stock
			ϕDc	ϕM	ϕdg	L		Ap max (mm)			
181128500	032R35190-03-07-M16040	3	32	M16	29	40	0,16	3,0	RNHX 1204 MOE...		
181128700	042R35190-04-07-M16040	4	42	M16	29	40	0,20	3,0	RNHX 1204 MOE...		

Stock item | Produto de stock | Itens de stock

Available under request (see page A-8) | Disponível sobre consulta (consulte a página A-8) | Disponible bajo consulta (mire pagina A-8)

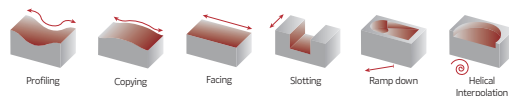

Weldon Shank
 $\gamma_p = -7^\circ$

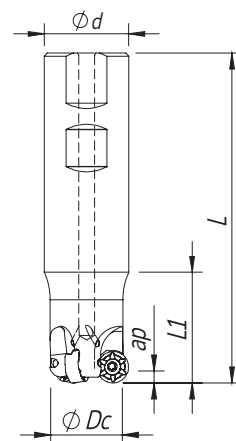

Order code Código	Reference Referência Referencia		Dimensions Dimensões Dimensiones (mm)				Kg	Specifications	Insert Pastilha Inserto	Stock
			ØDc	Ød/M	L	L1		Ap max (mm)		
181087000	032W35190-03-07-032125	3	32	32	125	42	0,98	3,0	RNHX 1204 MOE...	

Stock item | Produto de stock | Itens de stock

Available under request (see page A-9) | Disponível sobre consulta (consulte a página A-9) | Disponible bajo consulta (mire pagina A-9)

RNHX 1204... || Inserts | Pastilhas | Plaquetas

RNHX-LP

RNHX-MP

RNHX-LP | MP

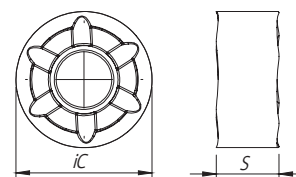

Geometry code (1)	ISO Reference	P			M			K		S		Dimensions Dimensões Dimensiones (mm)	
		PVD			PVD			PVD		PVD		IC	S
		T1	P4	Z2	X9	Z2	Z3	T1	P4	X9	Z3		
1112030	RNHX 1204 MOE-LP											12,00	4,76
1112052	RNHX 1204 MOE-MP											12,00	4,76

First choice | Primeira opção | 1ª opción

Stock item | Produto de stock | Itens de stock

Available under request (see page A-9) | Disponível sobre consulta (consulte a página A-9) | Disponible bajo consulta (mire pagina A-9)

Insert order code = (1) Geometry Code + (2) Grade Code

TOROMILL X2 35190

SPARE PARTS | Complementos | Repuestos

Cutter ØDc	Insert Screw	Key (Torx)	Order separately	
			Key (Torx - Nm)	Torque Value
35190	P0401065	XT15	DT1530	3,00

Note: The toolholder is supplied with the XT/PT key. To order the DT key please check the page A-241.
Check the procedures for the clamping screws on the page A-241.

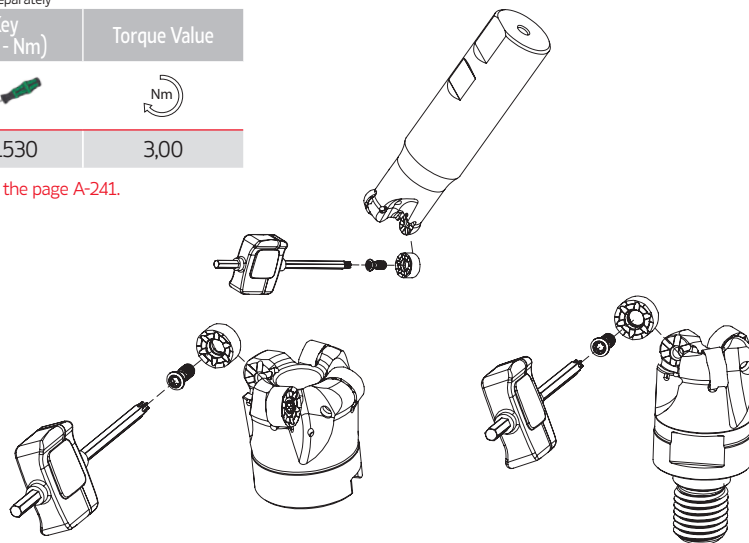

GRADES SELECTION GUIDE | Guia para selección de graus | Tabla para selección de calidades

ISO	PSM	Material	HB (Brinell)	Grades				
				← Wear Resistance			Toughness →	
				PHP920	PHP930	PHH930	PHP530	PHH530
P	1	Unalloyed Steel	125-220	✓	✓		✓	
	2	Low-Alloyed Steel	220-280	✓	✓		✓	
	3	High-Alloyed Steel	280-380	✓	✓		✓	
M	4	SS - Ferritic / Martensitic	200-330			✓	✓	✓
	5	SS - Austenitic	200-330			✓		✓
	6	SS - Austenitic-ferritic (Duplex)	230-260			✓		✓
K	7	Malleable Cast Iron	130-230	✓	✓			
	8	Grey Cast Iron	180-245	✓	✓			
	9	Nodular Cast iron	160-250	✓	✓			
S	11	Heat Resistant Super Alloys	200-320			✓		✓

Good Conditions
 Average Conditions
 Difficult Conditions

RECOMMENDED CUTTING CONDITIONS | Condições de corte recomendadas | Condiciones de corte recomendables

ISO	PSM	Material	HB (Brinell)	Vc (m/min)					RNHX... 12	
				← Wear Resistance			Toughness →		LP	MP
				PHP920	PHP930	PHH930	PHP530	PHH530		
P	1	Unalloyed Steel	125-220	180-250	160-230	-	180-340	-	0,15-0,45	0,15-0,50
	2	Low-Alloyed Steel	220-280	160-230	140-210	-	180-340	-	0,15-0,45	0,15-0,50
	3	High-Alloyed Steel	280-380	140-220	120-200	-	180-330	-	0,15-0,45	0,15-0,45
M	4	SS - Ferritic / Martensitic	200-330	-	-	140-210	150-270	170-280	0,10-0,35	-
	5	SS - Austenitic	200-330	-	-	120-170	-	160-280	0,10-0,35	-
	6	SS - Austenitic-ferritic (Duplex)	230-260	-	-	100-150	-	150-260	0,10-0,35	-
K	7	Malleable Cast Iron	130-230	-	150-280	-	-	-	-	0,15-0,55
	8	Grey Cast Iron	180-245	-	130-230	-	-	-	-	0,15-0,55
	9	Nodular Cast iron	160-250	-	80-190	-	-	-	-	0,15-0,50
S	11	Heat Resistant Super Alloys	200-320	-	-	30-110	-	30-150	0,05-0,30	-

CHIP-BREAKER SELECTION GUIDE | Guia para aplicações do quebra-afaras | Guía para aplicación del rompevirutas

ISO	PSM	Material	HB (Brinell)	Chip-Breaker Application	
				1st choice	Difficult Operations
P	1	Unalloyed Steel	125-220	LP	MP
	2	Low-Alloyed Steel	220-280	LP	MP
	3	High-Alloyed Steel	280-380	MP	-
M	4	SS - Ferritic / Martensitic	200-330	LP	-
	5	SS - Austenitic	200-330	LP	-
	6	SS - Austenitic-ferritic (Duplex)	230-260	LP	-
K	7	Malleable Cast Iron	130-230	MP	-
	8	Grey Cast Iron	180-245	MP	-
	9	Nodular Cast iron	160-250	MP	-
S	11	Heat Resistant Super Alloys	200-320	LP	-

RAMPING | Descida em rampa | Bajada en rampa

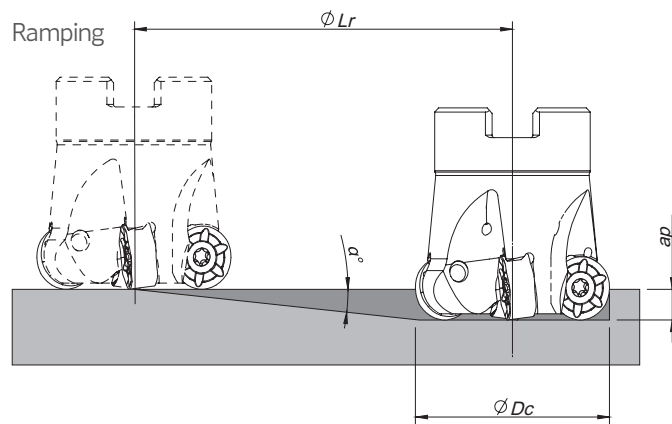

Insert	ϕDc	Ramping		
		Max Ramp a°	Max ap	Min Lr
RNHX 1204	32	1	3	171,9
	40	0,8	3	214,8
	42	0,8	3	214,8
	50	0,8	3	214,8
	63	0,6	3	286,5
	80	0,5	3	343,8

TOROMILL 24590 | 25090 | 25190

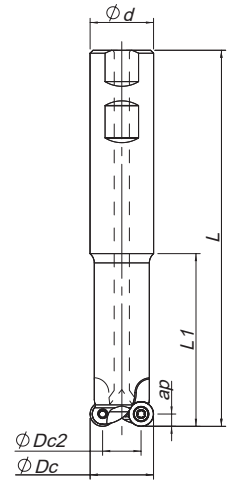

Weldon Shank

$$\gamma_p = 0^\circ$$

Order code Código	Reference Referência Referencia		Dimensions Dimensões Dimensiones (mm)							Kg	Specifications	Insert Pastilha Inserto	Stock	
			ϕDc	$\phi Dc2$	ϕd	ϕdg	L	L1	L2		A_p max (mm)			
24590														
181047000	015W24590-02-U016160		2	15	8	16	-	160	60	40	0,220	3,5	RD... 0702...	
181047100	015W24590-02-U025220		2	15	8	25	-	220	120	40	0,600	3,5	RD... 0702...	
25090														
181047200	020W25090-02-020160		2	20	10	20	-	160	60	-	0,322	5,0	RD... 1003...	
181047300	020W25090-02-025220		2	20	10	25	-	220	120	60	0,610	5,0	RD... 1003...	
25190														
181047400	025W25190-02-025220		2	25	13	25	-	220	120	-	0,678	6,0	RD... 12T3...	
181047500	025W25190-02-032230		2	25	13	32	-	230	130	80	1,015	6,0	RD... 12T3...	

Stock item | Produto de stock | Itens de stock

Available under request (see page A-8) | Disponível sobre consulta (consulte a página A-8) | Disponible bajo consulta (mire página A-8)

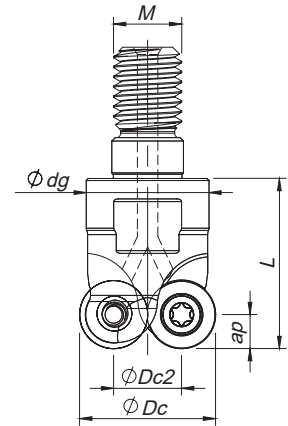

Threaded Coupling

$$\gamma_p = 0^\circ$$

Order code Código	Reference Referência Referencia		Dimensions Dimensões Dimensiones (mm)					Kg	Specifications	Insert Pastilha Inserto	Stock	
			ϕDc	$\phi Dc2$	ϕM	ϕdg	L		A_p max (mm)			
24590												
181015400	015R24590-03-M08020		3	15	8	M8	13	20	0,019	3,5	RD... 0702...	
181019100	016R24590-02-M08020		2	16	9	M8	13	20	0,019	3,5	RD... 0702...	
181037900	016R24590-03-M08020		3	16	9	M8	13	20	0,019	3,5	RD... 0702...	
181011400	020R24590-04-M10025		4	20	13	M10	18	25	0,047	3,5	RD... 0702...	
25090												
181011500	020R25090-02-M10025		2	20	10	M10	18	25	0,041	5,0	RD... 1003...	
181011600	025R25090-03-M12030		3	25	15	M12	21	30	0,075	5,0	RD... 1003...	
181011700	030R25090-04-M16035		4	30	20	M16	29	35	0,190	5,0	RD... 1003...	
181015500	035R25090-05-M16043		5	35	25	M16	29	43	0,240	5,0	RD... 1003...	
181049900	042R25090-05-M16040		5	42	32	M16	29	40	0,243	5,0	RD... 1003...	
25190												
181011800	024R25190-02-M12032		2	24	12	M12	21	32	0,072	6,0	RD... 12T3...	
181011900	035R25190-03-M16042		3	35	23	M16	29	42	0,205	6,0	RD... 12T3...	
181012000	042R25190-04-M16042		4	42	30	M16	29	42	0,232	6,0	RD... 12T3...	

Stock item | Produto de stock | Itens de stock

Available under request (see page A-8) | Disponível sobre consulta (consulte a página A-8) | Disponible bajo consulta (mire página A-8)



Arbor Mounting

$$\gamma_p = 0^\circ (*+7^\circ)$$

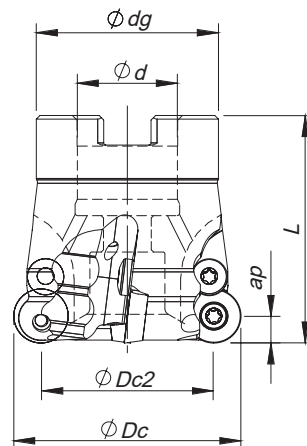

Order code Código	Reference Referência Referencia		Dimensions Dimensões Dimensiones (mm)					Kg	Specifications		Insert Pastilha Inserto	Stock
			ϕDc	$\phi Dc2$	ϕd	ϕdg	L		Arbor Type	Ap max (mm)		
25090												
181010600	042A25090-06-016044	6	42	32	16	36	44	0,254	A	5,0	RD... 1003...	
181017500	052A25090-07-022050	7	52	42	22	40	50	0,395	A	5,0	RD... 1003...	
25190												
181051900	050C25190-05-07-022050*	5	50	38	22	40	50	0,312	A	6,0	RD... 12T3...	
181010700	052C25190-05-022050	5	52	40	22	40	50	0,337	A	6,0	RD... 12T3...	
181010800	052C25190-05-07-022050*	5	52	40	22	40	50	0,335	A	6,0	RD... 12T3...	
181016100	066C25190-06-027050	6	66	54	27	48	50	0,550	A	6,0	RD... 12T3...	
181010900	066C25190-06-07-027050*	6	66	54	27	48	50	0,600	A	6,0	RD... 12T3...	
181016500	080C25190-07-027050	7	80	68	27	60	50	1,000	A	6,0	RD... 12T3...	
181016600	080C25190-07-07-027052*	7	80	68	27	60	52,5	1,000	A	6,0	RD... 12T3...	

Stock item | Produto de stock | Itens de stock

Available under request (see page A-8) | Disponível sobre consulta (consulte a página A-8) | Disponible bajo consulta (mire pagina A-8)

SPARE PARTS | Complementos | Repuestos

Cutter ϕDc	Insert Screw	Key (Torx)	Order separately		Screw Clamp
			Key (Torx - Nm)	Torque Value	
W24590 - 15	P0250503	XT08	DT0812	1,2	-
R24590 - 15-20	P0250503	XT08	DT0812	1,2	-
W25090 - 20	P0350800	XT15	DT1530	3,0	-
R25090 - 20-42	P0350800	XT15	DT1530	3,0	-
A25090 - 42-52	P0350800	XT15	DT1530	3,0	-
W25190 - 25	P0350800	XT15	DT1530	3,0	-
R25190 - 24-42	P0350800	XT15	DT1530	3,0	-
C25190 - 50-80	P0350800	XT15	DT1530	3,0	P0350750

Note: The toolholder is supplied with the XT/PT key. To order the DT key please check the page A-241.
Check the procedures for the clamping screws on the page A-241.

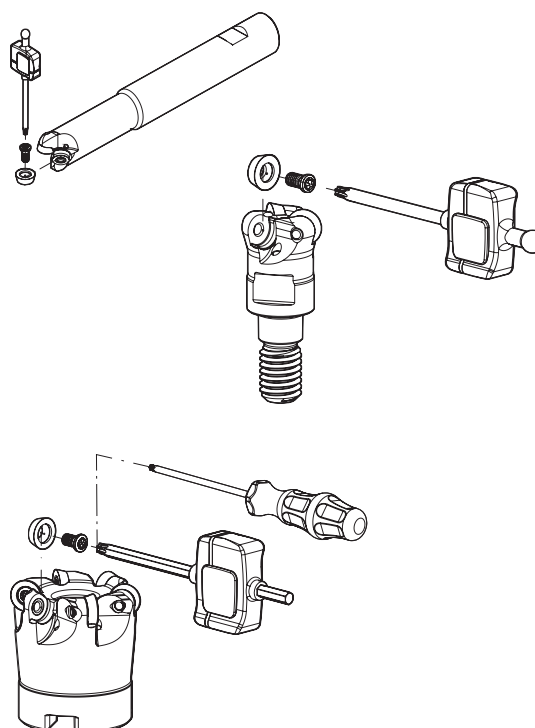

TOROMILL 25290 | 25390

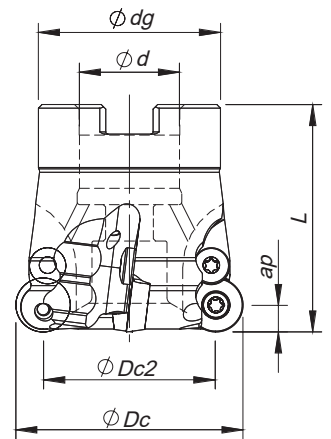

Arbor Mounting

$$\gamma_p = 0^\circ (*+7^\circ)$$

Order code Código	Reference Referência Referencia		Dimensions Dimensões Dimensiones (mm)					Kg	Specifications		Insert Pastilha Inserto	Stock
			ϕDc	$\phi Dc2$	ϕd	ϕdg	L		Arbor Type	Ap max (mm)		
25290												
181017900	052C25290-04-022050	4	52	36	22	40	50	0,305	A	8,0	RD... 1604...	
181018000	052C25290-04-07-022050*	4	52	36	22	40	50	0,324	A	8,0	RD... 1604...	
181011000	066C25290-05-027050	5	66	50	27	48	50	0,550	A	8,0	RD... 1604...	
181016700	066C25290-05-07-027050*	5	66	50	27	48	50	0,550	A	8,0	RD... 1604...	
181016200	080C25290-06-027052	6	80	64	27	60	52	0,910	A	8,0	RD... 1604...	
181011100	080C25290-06-07-027052*	6	80	64	27	60	52	0,934	A	8,0	RD... 1604...	
181017300	125C25290-08-07-U040052*	8	125	109	40	90	52	2,340	B	8,0	RD... 1604...	
181017400	160C25290-09-07-U040052*	9	160	144	40	120	52	4,750	B	8,0	RD... 1604...	
25390												
181026400	080C25390-05-07-027050*	5	80	60	27	60	50	0,840	A	10,0	RD... 2006...	
181016800	100C25390-06-07-U032052*	6	100	80	32	70	52	1,180	B	10,0	RD... 2006...	
181020500	125C25390-07-07-U040052*	7	125	105	40	90	52	2,030	B	10,0	RD... 2006...	
181020600	160C25390-08-07-U040052*	8	160	140	40	120	52	4,320	B	10,0	RD... 2006...	

Stock item | Produto de stock | Itens de stock

Available under request (see page A-8) | Disponível sobre consulta (consulte a página A-8) | Disponible bajo consulta (mire pagina A-8)

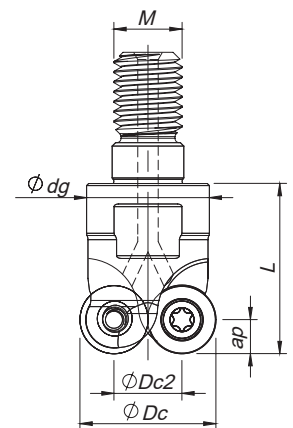

Threaded Coupling

$$\gamma_p = 0^\circ$$

Order code Código	Reference Referência Referencia		Dimensions Dimensões Dimensiones (mm)					Kg	Specifications		Insert Pastilha Inserto	Stock
			ϕDc	$\phi Dc2$	ϕM	ϕdg	L		Ap max (mm)			
25290												
181002600	032R25290-02-M16040	2	32	16	M16	29	40	0,162	8,0	RD... 1604...		
181034800	032R25290-03-M16042	3	35	19	M16	29	42	0,230	8,0	RD... 1604...		

Stock item | Produto de stock | Itens de stock

Available under request (see page A-8) | Disponível sobre consulta (consulte a página A-8) | Disponible bajo consulta (mire pagina A-8)



RD... || Inserts | Pastilhas | Plaquetas

RDHT

RDHW

RDMT

RDMW

RDHT | RDHW | RDMT | RDMW

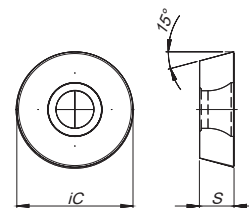
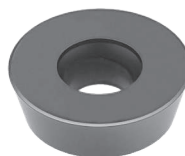
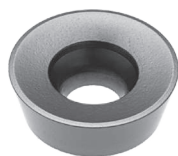
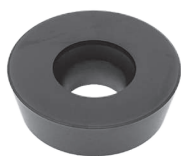
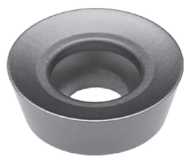

(1) Geometry code	(2) Grade code	P						K			H	Dimensions Dimensões Dimensiones (mm)	
		PVD						PVD			PVD		
		M6	54	68	78	86	I5	54	68	I5	M6		
	ISO Reference	PH6103	PH6910	PH6920	PH6125	PH6135	PH6740	PH6910	PH6920	PH6740	PH6103	iC	S
1110548	RDHW 0702 M0T	☉	☉	☉				☉	☉		☉	7,00	2,38
1110087	RDHW 1003 M0T	☉	☉	☉		☉		☉	☉		☉	7,00	2,38
1110082	RDHT 1003 M0T				☉	☉						10,00	3,18
1110583	RDMT 1003 M0T				☉	☉						10,00	3,18
1110549	RDMW 1003 M0T			☉	☉	☉						10,00	3,18
1110090	RDHW 12T3 M0T	☉	☉	☉		☉		☉	☉		☉	10,00	3,18
1112040	RDHT 12T3 M0S-MP			☉			☉		☉	☉		10,00	3,18
1110083	RDHT 12T3 M0T				☉	☉						12,00	3,97
1110558	RDMT 12T3 M0T				☉	☉						12,00	3,97
1110096	RDMW 12T3 M0T			☉	☉	☉			☉			12,00	3,97
1110092	RDHW 1604 M0T	☉	☉	☉		☉		☉	☉		☉	12,00	3,97
1112039	RDHT 1604 M0S-MP			☉			☉		☉	☉		12,00	3,97
1110084	RDHT 1604 M0T				☉	☉						16,00	4,76
1110556	RDMT 1604 M0T				☉	☉						16,00	4,76
1110097	RDMW 1604 M0T			☉	☉	☉			☉			16,00	4,76
1110869	RDMW 2006 M0T				☉							20,00	6,35

☉ First choice | Primeira opção | 1ª opción ☉ Stock item | Produto de stock | Itens de stock ○ Available under request (see page A-9) | Disponível sobre consulta (consulte a página A-9) | Disponible bajo consulta (mire página A-9) Insert order code = (1) Geometry Code + (2) Grade Code

A

MILLING

Overview

Face milling

Hi-feed milling

Shoulder milling

Profile milling

Hardmill

Center & Chamfer

Spot face

Spare Parts

Technical Data

End Mills

TOROMILL 24590 | 25090 | 25190 | 25290 | 25390

SPARE PARTS | Complementos | Repuestos

Cutter ØDc	Insert Screw	Key (Torx)	Order separately		Order separately		
			Key (Torx - Nm)	Torque Value	Screw Clamp	Washer	Washer Screw
W24590 - 15	P0250503	XT08	DT0812	1,2	-	-	-
R24590 - 15-20	P0250503	XT08	DT0812	1,2	-	-	-
W25090 - 20	P0350800	XT15	DT1530	3,0	-	-	-
R25090 - 20-42	P0350800	XT15	DT1530	3,0	-	-	-
A25090 - 42-52	P0350800	XT15	DT1530	3,0	-	-	-
W25190 - 25	P0350800	XT15	DT1530	3,0	-	-	-
R25190 - 24-42	P0350800	XT15	DT1530	3,0	-	-	-
C25190 - 50-80	P0350800	XT15	DT1530	3,0	P0350750	-	-
R25290 - 32-35	P0451001	XT20	DT2050	5,0	-	-	-
C25290 - 52-80	P0451001	XT20	DT2050	5,0	-	HC01200	P0451001
C25290 - 125-160	P0451001	XT20	DT2050	5,0	-	HC01200	P0451001
C25390 - 80-160	P0601402	TT20	-	10,0	-	HC01200	P0451001

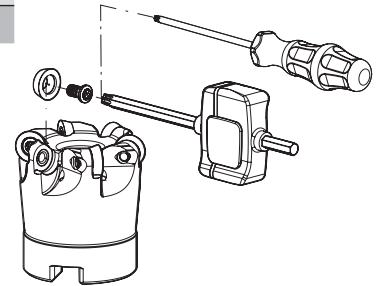
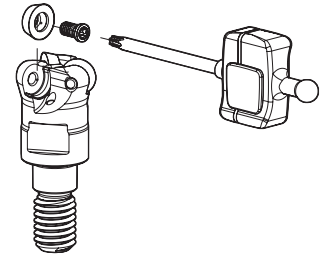
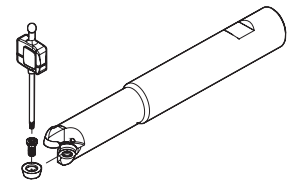

Note: The toolholder is supplied with the XT/PT key. To order the DT key please check the page A-241.
Check the procedures for the clamping screws on the page A-241.

GRADES SELECTION GUIDE | Guia para selección de graus | Tabla para selección de calidades

ISO	PSM	Material	HB (Brinell)	Grades					
				← Wear Resistance			Toughness →		
				PH6103	PH6910	PH6920	PH6125	PH6135	PH6740
P	1	Unalloyed Steel	125-220	●	●	●	●	●	●
	2	Low-Alloyed Steel	220-280	●	●	●	●	●	●
	3	High-Alloyed Steel	280-380	●	●	●	●	●	●
K	7	Malleable Cast Iron	130-230		●	●			●
	8	Grey Cast Iron	180-245		●	●			●
	9	Nodular Cast iron	160-250		●	●			●
H	12	Hardened Steels	40-55 HRC	●					

- Good Conditions
- Average Conditions
- Difficult Conditions

CHIP-BREAKER SELECTION GUIDE | Guia para aplicações do quebra- aparas | Guía para aplicación del rompevirutas

ISO	PSM	Material	HB (Brinell)	Chip-Breaker Application	
				1st choise	Dificult Operations
P	1	Unalloyed Steel	125-220	RD...T ...	RD...W ...
	2	Low-Alloyed Steel	220-280	RD...T ...	-
	3	High-Alloyed Steel	280-380	RD...W ...	-
K	7	Malleable Cast Iron	130-230	RD...T ...	RD...W ...
	8	Grey Cast Iron	180-245	RD...W ...	-
	9	Nodular Cast iron	160-250	RD...W ...	-
H	12	Hardened Steels	40-55 HRC	RD...W ...	-

A

MILLING

Overview

Face milling

Hifeed milling

Shoulder milling

Profile milling

Hardmill

Center & Chamfer

Spot face

Spare Parts

Technical Data

End Mills

TOROMILL 24590 | 25090 | 25190 | 25290 | 25390

RECOMMENDED CUTTING CONDITIONS | Condições de corte recomendadas | Condiciones de corte recomendables

ISO	PSM	Material	HB (Brinell)	Vc (m/min)					
				← Wear Resistance				Toughness →	
				PH6103	PH6910	PH6920	PH6125	PH6135	PH6740
P	1	Unalloyed Steel	125-220	180-300	180-250	150-230	160-190	150-180	130-160
	2	Low-Alloyed Steel	220-280	180-250	170-210	140-220	140-180	140-170	120-150
	3	High-Alloyed Steel	280-380	180-230	160-200	130-180	130-160	120-150	100-130
K	7	Malleable Cast Iron	130-230	-	170-300	150-280	-	-	130-250
	8	Grey Cast Iron	180-245	-	150-250	130-230	-	-	110-220
	9	Nodular Cast iron	160-250	-	90-210	80-190	-	-	80-170
H	12	Hardened Steels	40-55 HRC	120-240	-	-	-	-	-

ISO	PSM	Material	HB (Brinell)	RD... 07		RD... 10		RD... 12	
				fz (mm/t)	ap (mm)	fz (mm/t)	ap (mm)	fz (mm/t)	ap (mm)
P	1	Unalloyed Steel	125-220	≤0,18	≤1,50	≤0,24	≤2,50	≤0,27	≤2,50
	2	Low-Alloyed Steel	220-280	≤0,18	≤1,50	≤0,24	≤2,50	≤0,25	≤2,50
	3	High-Alloyed Steel	280-380	≤0,15	≤1,50	≤0,21	≤2,50	≤0,20	≤2,50
K	7	Malleable Cast Iron	130-230	≤0,20	≤1,50	≤0,25	≤2,50	≤0,24	≤2,50
	8	Grey Cast Iron	180-245	≤0,20	≤1,50	≤0,25	≤2,50	≤0,24	≤2,50
	9	Nodular Cast iron	160-250	≤0,18	≤1,50	≤0,22	≤2,50	≤0,22	≤2,50
H	12	Hardened Steels	40-55 HRC	≤0,12	≤1,50	≤0,18	≤2,50	≤0,18	≤2,50

ISO	PSM	Material	HB (Brinell)	RD... 16		RD... 20	
				fz (mm/t)	ap (mm)	fz (mm/t)	ap (mm)
P	1	Unalloyed Steel	125-220	≤0,33	≤3,50	≤0,33	≤5,00
	2	Low-Alloyed Steel	220-280	≤0,33	≤3,50	≤0,33	≤5,00
	3	High-Alloyed Steel	280-380	≤0,27	≤3,50	≤0,27	≤5,00
K	7	Malleable Cast Iron	130-230	≤0,35	≤3,50	≤0,35	≤5,00
	8	Grey Cast Iron	180-245	≤0,35	≤3,50	≤0,35	≤5,00
	9	Nodular Cast iron	160-250	≤0,32	≤3,50	≤0,32	≤5,00
H	12	Hardened Steels	40-55 HRC	≤0,25	≤3,50	≤0,20	≤5,00

(Note 1) Cutting conditions $a_e/D_c=70\%$.

(Note 2) Cutting conditions should be adjusted according to the machine and work rigidity.

(Note 3) It's possible to occur vibrations in certain cases. Please reduce depth of cut and / or reduce cutting conditions in following cases:

- When using long shank;
- When using long tool overhang with arbor type;
- When application has poor clamping rigidity or when using a low rigidity machine.

RAMPING AND HELICAL INTERPOLATION

Descida em rampa e interpolação helicoidal | Bajada en rampa e interpolación circular

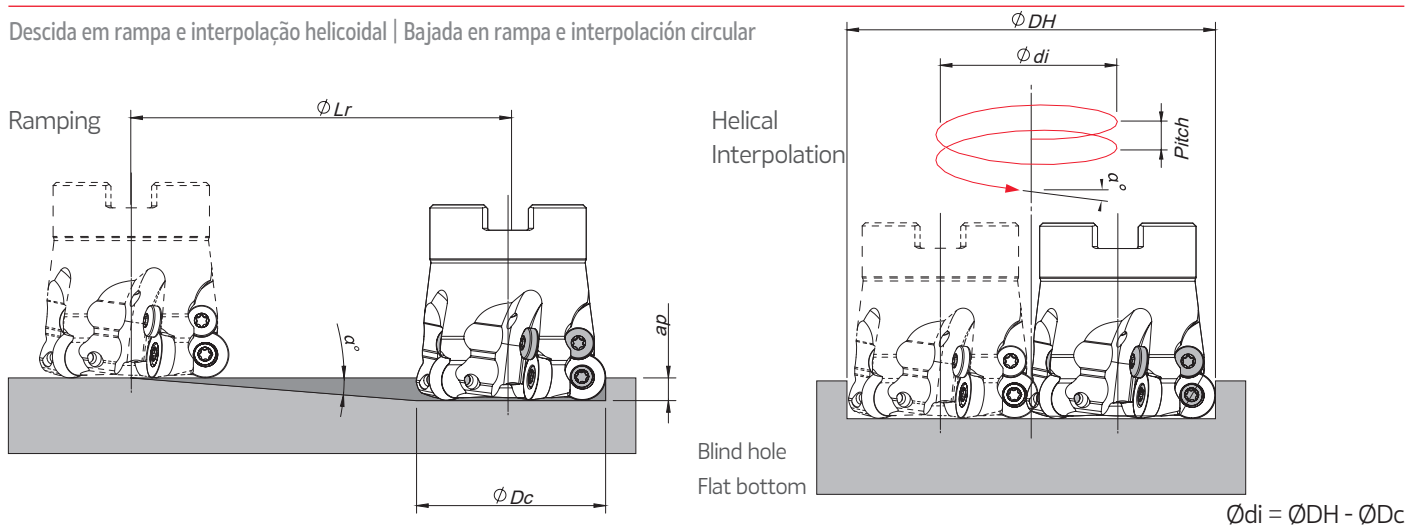

$$\phi_{di} = \phi_{DH} - \phi_{Dc}$$

Insert	ϕ_{Dc}	Ramping			Helical Interpolation		
		Max Ramp α°	Max a_p	Min Lr	ϕ_{DHmin}	ϕ_{DHmax}	Max Pitch/Rev.
RD... 07	15	9,4	3,5	21,1	23,0	-	4,0
	16	8	3,5	24,9	25,0	30,0	7,0
	20	6	3,5	33,3	-	-	3,0
RD... 10	20	25,0	5,0	10,7	33,0	40,0	7,0
	25	22,0	5,0	12,4	-	-	4,0
	30	13,5	5,0	20,8	-	30,0	6,0
	35	12,0	5,0	23,5	30,0	40,0	14,0
	42	10,0	5,0	28,4	40,0	50,0	29,0
	52	7,0	5,0	40,7	50,0	60,0	19,0
RD... 12	24	17,0	6,0	19,6	60,0	70,0	15,0
	25	16,2	6,0	20,7	70,0	84,0	22,0
	35	12,0	6,0	28,2	84,0	104,0	23,0
	42	10,3	6,0	33,0	94,0	104,0	16,0
	50	6,4	6,0	53,5	104,0	-	20,0
	52	6,0	6,0	57,1	-	-	11,1
	66	3,5	6,0	79,8	36,0	48,0	23,0
	80	2,5	6,0	104,1	48,0	64,0	18,0
RD... 16	32	20,0	8,0	22,0	64,0	70,0	36,0
	35	18,0	8,0	24,6	70,0	88,0	19,0
	52	13,0	8,0	34,7	88,0	104,0	35,0
	66	8,5	8,0	53,5	104,0	116,0	26,0
	80	6,0	8,0	76,1	116,0	132,0	37,0
	125	3,5	8,0	130,8	132,0	144,0	23,0
	160	2,5	8,0	183,2	144,0	160,0	30,0
RD... 20	80	6,0	10,0	76,1	160,0	200,0	21,0
	100	5,0	10,0	91,4	200,0	230,0	26,0
	125	4,5	10,0	101,6	230,0	250,0	21,0
	160	3,0	10,0	152,6	250,0	320,0	27,0

Note: During helical interpolation do not exceed max Pitch.

LINEPRO 40095 | 40595 | 41095

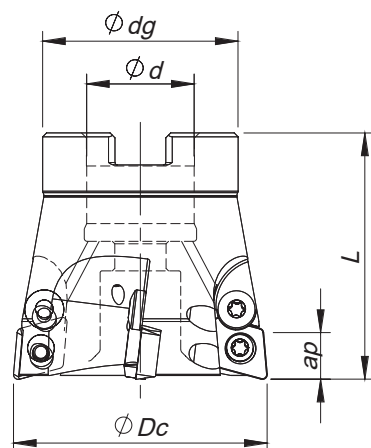

Arbor Mouting

$K_r=95^\circ$ | $\gamma_p=+7^\circ$

Order code Código	Reference Referência Referencia		Dimensions Dimensões Dimensiones (mm)				Kg	Specifications		Insert Pastilha Inserto	Stock
			ϕDc	ϕd	ϕdg	L		Arbor Type	Ap max (mm)		
40595											
181027700	052C40595-05-07-022050	5	52	22	40	50	0,342	A	1,0	XD... 10T3...	
181027800	066C40595-06-07-027050	6	66	27	48	50	0,565	A	1,0	XD... 10T3...	
181027900	080C40595-07-07-027050	7	80	27	60	50	0,972	A	1,0	XD... 10T3...	

Stock item | Produto de stock | Itens de stock

Available under request (see page A-8) | Disponível sobre consulta (consulte a página A-8) | Disponible bajo consulta (mire pagina A-8)

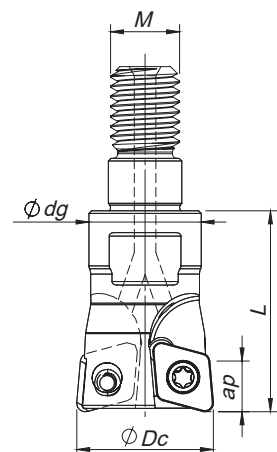

Threaded Coupling

$K_r=95^\circ$ | $\gamma_p=+7^\circ$ (*+9)

Order code Código	Reference Referência Referencia		Dimensions Dimensões Dimensiones (mm)				Kg	Specifications		Insert Pastilha Inserto	Stock
			ϕDc	ϕM	ϕdg	L		Ap max (mm)			
41095											
181012400	010R41095-02-09-M06020*	2	10	M6	9,8	20	0,010	0,8	XD... 0401...		
181016300	012R41095-02-09-M06020*	2	12	M6	9,8	20	0,012	0,8	XD... 0401...		
40095											
181012100	016R40095-02-07-M08023	2	16	M8	13	23	0,022	1,0	XD... 0602...		
181012200	020R40095-03-07-M10028	3	20	M10	18	28	0,050	1,0	XD... 0602...		
181015600	025R40095-03-07-M12030	3	25	M12	21	30	0,081	1,0	XD... 0602...		
181034000	025R40095-04-07-M12030	4	25	M12	21	30	0,078	1,0	XD... 0602...		
40595											
181015700	025R40595-02-07-M12035	2	25	M12	21	35	0,077	1,0	XD... 10T3...		
181012300	035R40595-03-07-M16043	3	35	M16	29	43	0,200	1,0	XD... 10T3...		
181016900	042R40595-04-07-M16043	4	42	M16	29	43	0,230	1,0	XD... 10T3...		

Stock item | Produto de stock | Itens de stock

Available under request (see page A-8) | Disponível sobre consulta (consulte a página A-8) | Disponible bajo consulta (mire pagina A-8)

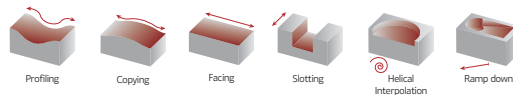

XDHW | Inserts | Pastilhas | Plaquetas

XDHW

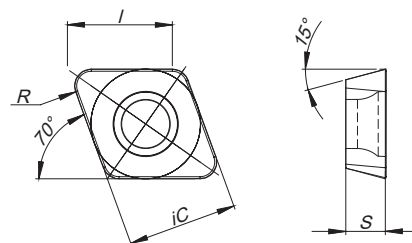

XDHW - PCD & PCBN
(HARDMILL)

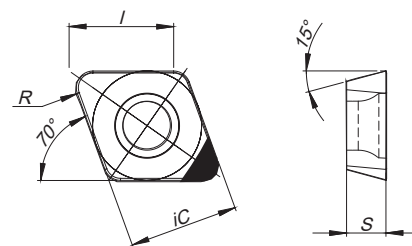
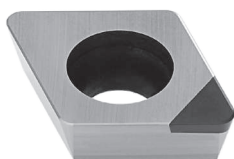

(1) Geometry code	(2) Grade code ISO Reference	P				K		N		H		Dimensions Dimensões Dimensiones (mm)			
		PVD				PVD		CVD	PCD	PVD	PCBN	iC	S	I	R
		M6	54	78	86	54	78	P2	D6	M6	S4				
1110905	XDHW 040105	○	○	○		○		⊗		○		4,00	1,59	4,00	0,50
1110573	XDHW 040110	⊗	⊗	⊗		⊗	⊗	⊗		⊗		4,00	1,59	4,00	1,00
1112316	XDHW 040110 FN								⊗			4,00	1,59	4,00	1,00
1112317	XDHW 040110 SN										⊗	4,00	1,59	4,00	1,00
1110532	XDHW 060210	⊗	⊗	⊗	⊗	⊗	⊗	⊗		⊗		6,50	2,38	6,20	1,00
1112318	XDHW 060210 FN								⊗			6,50	2,38	6,20	1,00
1111875	XDHW 060210 SN										⊗	6,50	2,38	6,20	1,00
1110565	XDHW 10T310	⊗	⊗	⊗	⊗	⊗	⊗	○		⊗		10,00	3,97	9,90	1,00
1112320	XDHW 10T310 FN								⊗			10,00	3,97	9,90	1,00
1112321	XDHW 10T310 SN										⊗	10,00	3,97	9,90	1,00

⊗ First choice | Primeira opção | 1ª opción ⊗ Stock item | Produto de stock | Itens de stock ○ Available under request (see page A-9) | Disponível sobre consulta (consulte a página A-9) | Disponible bajo consulta (mire página A-9) Insert order code = (1) Geometry Code + (2) Grade Code

A

MILLING

Overview

Face milling

Hi-feed milling

Shoulder milling

Profile milling

Hardmill

Center & Chamfer

Spot face

Spare Parts

Technical Data

End Mills

LINEPRO 40095 | 40595 | 41095

SPARE PARTS | Complementos | Repuestos

Cutter ØDc	Insert Screw	Key (Torx)	Order separately		Order separately
			Key (Torx - Nm)	Torque Value	Screw Clamp
R41095 - 10 - 12	P0180401	XT06	DT0606	0,6	-
R40095 - 16 - 25	P0250503	XT08	DT0812	1,2	-
R40595 - 25 - 42	P0350800	XT15	DT1530	3,0	-
C40595 - 52 - 80	P0350800	XT15	DT1530	3,0	P0350750

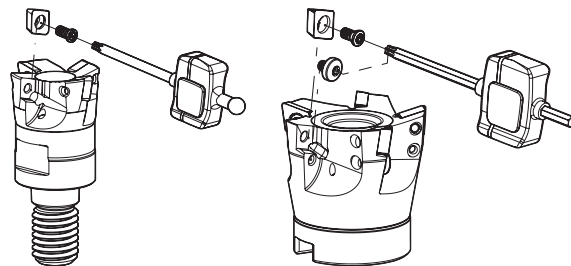

Note: The toolholder is supplied with the XT/PT key. To order the DT key please check the page A-241.
Check the procedures for the clamping screws on the page A-241.

GRADES SELECTION GUIDE | Guia para seleção de graus | Tabla para selección de calidades

ISO	PSM	Material	HB (Brinell)	Grades					PCD PDP410	PCBN PBH920
				← Wear Resistance			Toughness →			
				PHD103	PH6103	PH6910	PH6125	PH6135		
P	1	Unalloyed Steel	125-220		✓	✓	✓	✓		
	2	Low-Alloyed Steel	220-280		✓	✓	✓	✓		
	3	High-Alloyed Steel	280-380		✓	✓	✓	✓		
K	7	Malleable Cast Iron	130-230				✓			
	8	Grey Cast Iron	180-245				✓			
	9	Nodular Cast iron	160-250				✓			
N	10	Aluminium and Non Ferrous	30-130	✓					✓	
H	12	Hardened Steels	40-55 HRC		✓					✓



RECOMMENDED CUTTING CONDITIONS | Condições de corte recomendadas | Condiciones de corte recomendables

ISO	PSM	Material	HB (Brinell)	Vc (m/min)					PCD PDP410	PCBN PBH920
				← Wear Resistance			Toughness →			
				PHD103	PH6103	PH6910	PH6125	PH6135		
P	1	Unalloyed Steel	125-220	-	180-300	180-250	160-190	150-180	-	-
	2	Low-Alloyed Steel	220-280	-	180-250	170-210	140-180	140-170	-	-
	3	High-Alloyed Steel	280-380	-	180-230	160-200	130-160	120-150	-	-
K	7	Malleable Cast Iron	130-230	-	-	170-300	160-290	-	-	-
	8	Grey Cast Iron	180-245	-	-	150-250	140-240	-	-	-
	9	Nodular Cast iron	160-250	-	-	90-210	80-200	-	-	-
N	10	Aluminium and Non Ferrous	30-130	300-1000	-	-	-	-	800-3000	-
H	12	Hardened Steels	40-55 HRC	-	120-260	-	-	-	-	200-600

Insert	Feed fz (mm/t)		ap Rec.
	Roughing	Finishing	
XD...04	0.10-0.20	0.10-0.15	0.1-0.5
XD...06	0.15-0.30	0.10-0.25	0.2-0.8
XD...10	0.15-0.35	0.10-0.30	0.2-0.8

(Note 1) Cutting conditions should be adjusted according to the machine and work rigidity.
(Note 2) If chattering occurs, reduce ap and Vc by 30% and keep the same fz per tooth.

RAMPING AND HELICAL INTERPOLATION

Descida em rampa e interpolação helicoidal | Bajada en rampa e interpolación circular

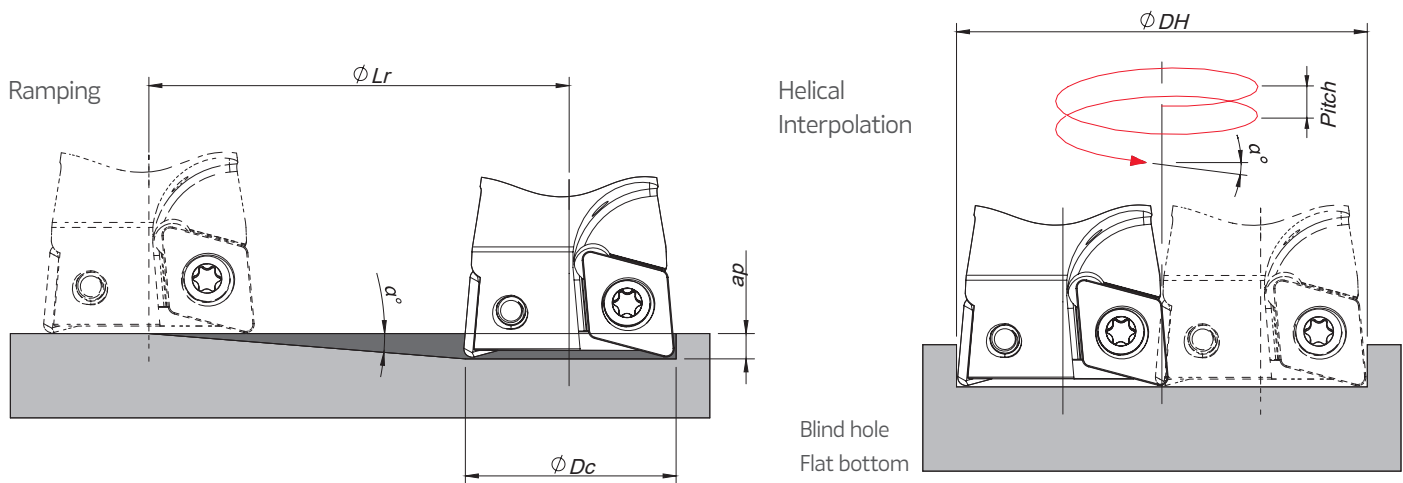

$$\phi di = \phi DH - \phi Dc$$

Insert	ϕDc	Ramping			Helical Interpolation		
		Max Ramp a°	Max a_p	Min L_r	ϕDH_{min}	ϕDH_{max}	Max Pitch/Rev.
XDHW 04...	10	7,3	0,8	6,2	18,0	-	3,2
	12	5,3	0,8	8,6	22,0	20,0	4,0
XDHW 06...	16	8	1,0	7,1	-	24,0	2,9
	20	5,7	1,0	10,0	30,0	-	3,5
	25	4	1,0	14,3	-	40,0	6,2
XDHW 10...	25	8,7	1,0	6,5	38,0	-	7,1
	35	5,2	1,0	11,0	48,0	-	5,6
	42	4	1,0	14,3	-	50,0	6,3
	52	3	1,0	19,1	48,0	-	5,1
	66	2,3	1,0	24,9	-	84,0	5,5
	80	1,8	1,0	31,8	102,0	-	11,1
					-	104,0	12,0

Note: During helical interpolation do not exceed max Pitch.

A

MILLING

Overview

Face milling

Hifeed milling

Shoulder milling

Profile milling

Hardmill

Center & Chamfer

Spot face

Spare Parts

Technical Data

End Mills

HARDMILL 72090

A

INSERTS CODIFICATION SYSTEM | Sistema de codificação de pastilhas | Sistema de codificación de insertos

MILLING

ISO CODE	Insert size	Insert thickness	Insert radius	Cutting edge position angle	Cutting edge relief angle	Cutting edge conditions	Cut direction	Wiper edge length	Máx. Ap
XNHW	12	05	04	P	Z	F	R	-	015 030

Overview

Face milling

Hifeed milling

Shoulder milling

Profile milling

Hardmill

Center & Chamfer

Spot face

Spare Parts

Technical Data

End Mills

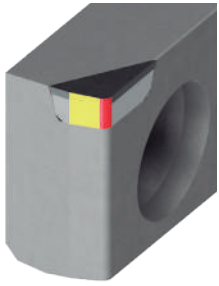

XNHW 120504 PZFR-0150045

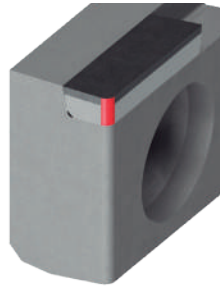

XNHW 120504 PZFR-000080

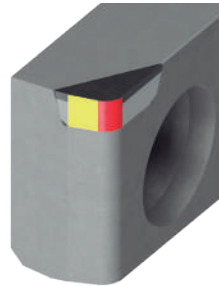

XNHW 120508 PZFR-015045

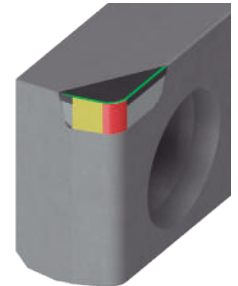

XNHW 120508 PZTR-015045



XNHW 120508 PZTR-000080

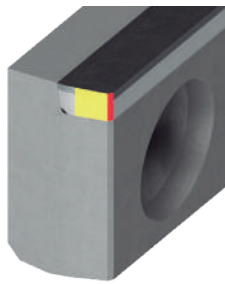

XNHW 1205 PZFR-020120

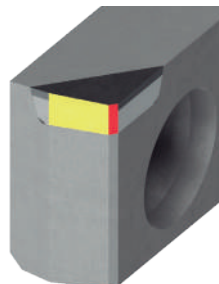

XNHW 1205 PZFR-030045

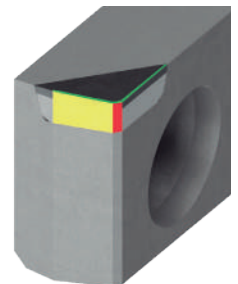

XNHW 1205 PZTR-030045

 Cutting edge Type (radius, chamfer)

 Wiper cutting edge

 Edge Preparation (F, T)

HARDMILL 72090

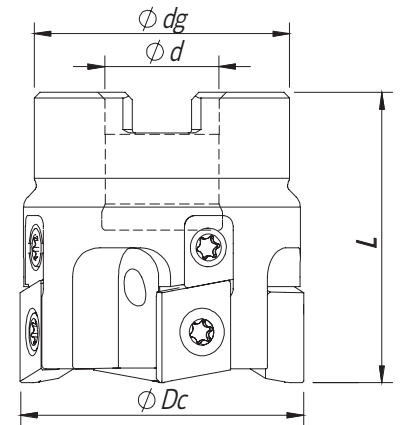

Arbor Mounting

$K_r=90^\circ$ | $\gamma_p=0^\circ$

Order code Código	Reference Referência Referencia		Dimensions Dimensões Dimensiones (mm)				Kg	Specifications		Insert Pastilha Inserto	Stock
			ϕDc	ϕd	ϕdg	L		Arbor Type	N max (mm)		
181129700	040A72090-04-016040	4	40	16	36	40	0,32	A	32 000	XNHW 1205...	
181129800	050A72090-04-022040	4	50	22	46	40	0,38	A	32 000	XNHW 1205...	
181129900	050A72090-05-022040	5	50	22	46	40	0,37	A	32 000	XNHW 1205...	
181130000	063A72090-04-022040	4	63	22	49	40	0,65	A	29 000	XNHW 1205...	
181130100	063A72090-07-022040	7	63	22	49	40	0,62	A	29 000	XNHW 1205...	
181130200	080A72090-05-027050	5	80	27	60	50	1,25	A	26 000	XNHW 1205...	
181130300	080A72090-09-027050	9	80	27	60	50	1,17	A	26 000	XNHW 1205...	
181130400	100A72090-06-032050	6	100	32	70	50	1,93	A	24 000	XNHW 1205...	
181130500	100A72090-12-032050	12	100	32	70	50	1,80	A	24 000	XNHW 1205...	
181130600	125A72090-08-040063	8	125	40	72	63	2,88	A	22 000	XNHW 1205...	
181130700	125A72090-14-040063	14	125	40	72	63	2,60	A	22 000	XNHW 1205...	
181135500	160A72090-10-040063	10	160	40	72	63	3,30	A	18 000	XNHW 1205...	
181135600	160A72090-16-040063	16	160	40	118	63	5,45	A	18 000	XNHW 1205...	

Stock item | Produto de stock | Itens de stock

Available under request (see page A-8) | Disponível sobre consulta (consulte a página A-8) | Disponible bajo consulta (mire pagina A-8)

SPARE PARTS || Complementos | Repuestos

Cutter ϕDc	Order separately				
	Insert Screw	Key (Torx)	Key (Torx - Nm)	Torque Value	Wedge
A72090 - 40-160	 P0401100	 XT15	 DT1530	 3,00	 SETDEV AS 04 00

Note: The toolholder is supplied with the XT/PT key. To order the DT key please check the page A-241.
Check the procedures for the clamping screws on the page A-241.

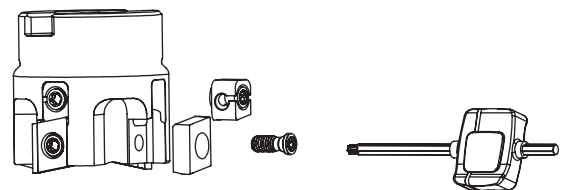

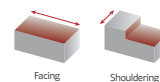

XNHW 1205... || Inserts | Pastilhas | Plaquetas

XNHW 1205 PZFR-020120

XNHW 120508 PZTR-000080

XNHW 120508 PZTR-015045

XNHW

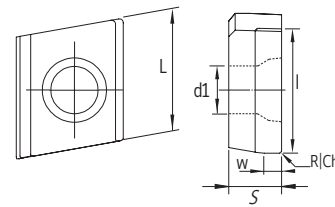
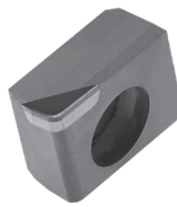
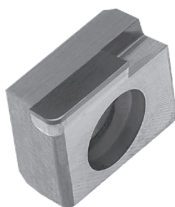
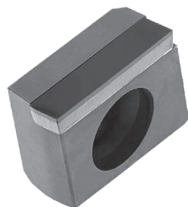

(1) Geometry code	(2) Grade code ISO Reference	N		Dimensions Dimensões Dimensiones (mm)					
		PCD		L	S	l	d1	r	W
		I3	D6						
		PDP403	PDP410						
1112564	XNHW 120504 PZFR-015045	○	○	12,25	5,40	4,50	4,80	0,40	1,50
1112565	XNHW 120504 PZFR-000080	○	○	12,25	5,40	8,00	4,80	0,40	-
1112566	XNHW 120508 PZFR-015045	⊗	○	12,25	5,40	4,50	4,80	0,80	1,50
1112551	XNHW 120508 PZTR-015045	⊗	○	12,25	5,40	4,50	4,80	0,80	1,50
1112552	XNHW 120508 PZTR-000080	⊗	○	12,25	5,40	8,00	4,80	0,80	-
1112553	XNHW 1205 PZFR-020120	⊗	○	12,25	5,40	12,00	4,80	-	2,00
1112567	XNHW 1205 PZFR-030045	○	○	12,25	5,40	4,50	4,80	-	3,00
1112568	XNHW 1205 PZTR-030045	○	○	12,25	5,40	4,50	4,80	-	3,00

⊗ First choice | Primeira opção | 1ª opción
 ⊗ Stock item | Produto de stock | Itens de stock
 ○ Available under request (see page A-9) | Disponível sobre consulta (consulte a página A-9) | Disponible bajo consulta (mire página A-9)
 Insert order code = (1) Geometry Code + (2) Grade Code

RECOMMENDED CUTTING CONDITIONS || Condições de corte recomendadas | Condiciones de corte recomendables

ISO	Material		HB (Brinell)	Vc (m/min)	Feed fz (mm/t)
	Work piece material	Type of treatment / alloy		PDP403	XNHW 12...
N	Aluminium wrought alloys		80	300 - 4000	0,05 - 0,40
			90	300 - 1500	
	Aluminium cast alloys	< 12% Si	130	300 - 5000	
		< 12% Si	90	300 - 3000	
		> 12% Si	100	300 - 1000	
	Non-metallic materials	brass, red bronze	100	100 - 700	
		bronze	-	100 - 1500	
		lead-free copper and electrolytic copper	-	300 - 3000	
		thermosetting plastics	-	80 - 300	
		fibre-reinforced plastics	200-320	80 - 300	
	hard rubber		80 - 300		

CENTER & CHAMFER

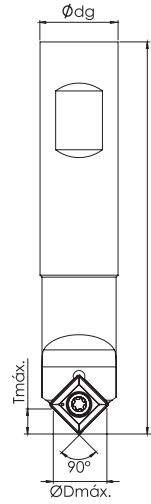

Order code Código	Reference Referência Referencia		Dimensions Dimensões Dimensiones (mm)						Kg	Insert Pastilha Inserto	Stock
			ØDmax.	Tmax.	Tmix.	Ødg	L	Angle °			
181147400	CHT S16H N11-45	1	13	6,5	1,0	16	100	45	0,146	SO..T 11T3..	
181147500	CHT S16M N11-45	1	13	6,5	1,0	16	150	45	0,180	SO..T 11T3..	

Order code Código	Designation Designação Designación	Nº Toolholder	Holder designation	Nº inserts	Insert Pastilha Inserto	Stock
1410286G4	PK SOMT 11T308 CHTS16H	1	CHT S16H N11-45	10	SOMT 11T308	
1410287G4	PK SOMT 11T308 CHTS16M	1	CHT S16M N11-45	10	SOMT 11T308	

Stock item | Produto de stock | Itens de stock

Available under request (see page A-8) | Disponível sobre consulta (consulte a página A-8) | Disponible bajo consulta (mire pagina A-8)

SO...T 11T... || Inserts | Pastilhas | Plaquetas

SOMT

SOGT NEW

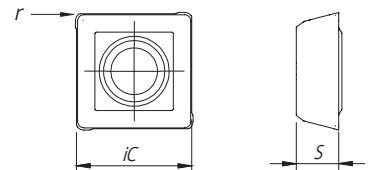

		P	M	K	Dimensions Dimensões Dimensiones (mm)			
		PVD	PVD	PVD	iC	S	l	r
⁽²⁾ Grade code		G4	G4	G4				
⁽¹⁾ Geometry code	ISO Reference	PH7920	PH7920	PH7920				
1112425	SOMT 11T308				10,87	3,97	11,00	0,80
1112973	SOGT 11T303				10,87	3,97	11,00	(0,30)

First choice | Primeira opção | 1ª opción

Stock item | Produto de stock | Itens de stock

Available under request (see page A-9) | Disponível sobre consulta (consulte a página A-9) | Disponible bajo consulta (mire pagina A-9)

Insert order code = (1) Geometry Code + (2) Grade Code

TOOL SELECTION || Selecção de ferramenta | Selección de herramienta

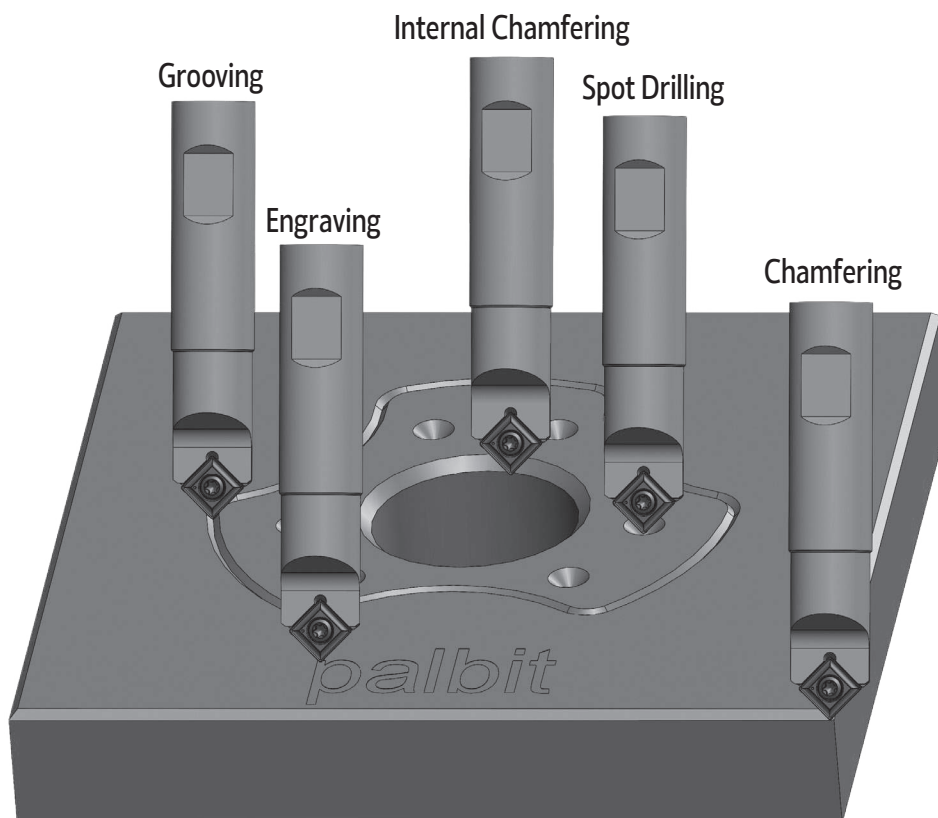

SPARE PARTS || Complementos | Repuestos

Cutter ØDc	Order separately			
	Insert Screw	Key (Torx)	Key (Torx - Nm)	Torque Value
CHT S16...	P0350800	XT15	DT1530	3,0

Note: The toolholder is supplied with the XT/PT key. To order the DT key please check the page A-241.
Check the procedures for the clamping screws on the page A-241.

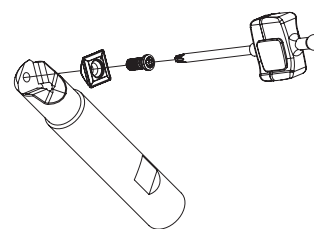

RECOMMENDED CUTTING CONDITIONS || Condições de corte recomendadas | Condiciones de corte recomendables

ISO	PSM	Material	HB (Brinell)	Vc (m/min)		Feed fz (mm/t)	
				PH7920	SOMT 11T308		
P	1	Unalloyed Steel	125-220	120-150		0,04-0,08	
	2	Low-Alloyed Steel	220-280	100-120		0,03-0,07	
	3	High-Alloyed Steel	280-380	60-100		0,03-0,06	
M	4	SS - Ferritic / Martensitic	200-330	100-150		0,04-0,07	
	5	SS - Austenitic	200-330	80-120		0,03-0,06	
	6	SS - Austenitic-ferritic (Duplex)	230-260	50-90		0,03-0,06	
K	7	Malleable Cast Iron	130-230	90-150		0,05-0,10	
	8	Grey Cast Iron	180-245	80-120		0,05-0,08	
	9	Nodular Cast iron	160-250	70-110		0,04-0,08	

SPOT FACE

A

MILLING

Overview

Face milling

Hi-feed milling

Shoulder milling

Profile milling

Hardmill

Center & Chamfer

Spot face

Spare Parts

Technical Data

End Mills



Note: Hole previously drilled

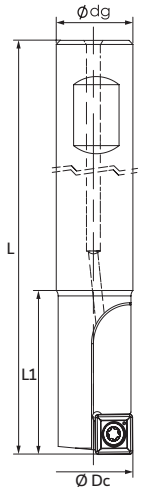

Order code Código	Reference Referência Referencia		Dimensions Dimensões Dimensiones (mm)				Kg	Insert Pastilha Inserto	Stock
			ØDc	Ødg	L	L1			
181150100	SP91 D10-W10/100-01-05	1	10	10	100	30	0,048	SPKX 05T104	
181150200	SP91 D11-W12/100-01-05	1	11	12	100	30	0,070	SPKX 05T104	
181150300	SP91 D13-W16/100-01-06	1	13	16	100	30	0,116	SPKX 060204	
181150400	SP91 D14-W16/120-01-06	1	14	16	120	30	0,123	SPKX 060204	
181150500	SP91 D17-W20/120-01-07	1	17	20	120	35	0,224	SPKX 070308	
181150600	SP91 D18-W20/140-01-07	1	18	20	140	35	0,272	SPKX 070308	
181150700	SP91 D20-W20/140-01-09	1	20	20	140	40	0,303	SPKX 090308	
181150800	SP91 D21-W25/150-01-09	1	21	25	150	40	0,449	SPKX 090308	
181150900	SP91 D25-W25/150-01-11	1	25	25	150	40	0,473	SPKX 110408	

Stock item | Produto de stock | Itens de stock

Available under request (see page A-8) | Disponível sobre consulta (consulte a página A-8) | Disponible bajo consulta (mire pagina A-8)

SPKX || Inserts | Pastilhas | Plaquetas

(PHC grade)

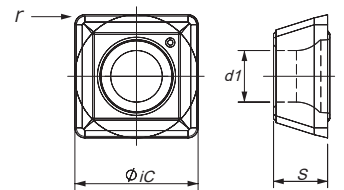

Geometry code	ISO Reference	P			M			K			Dimensions Dimensões Dimensiones (mm)			
		PVD			PVD			PVD			IC	S	d1	r
		68	66	J3	68	66	J3	68	66	J3				
1111635	SPKX 05T104										5,00	1,98	2,20	0,40
1111282	SPKX 060204										6,00	2,38	2,55	0,80
1111636	SPKX 070308										7,94	3,18	2,85	0,80
1111637	SPKX 090308										9,80	3,18	4,10	0,80
1111285	SPKX 110408										11,50	4,80	4,40	0,80

First choice | Primeira opção | 1ª opción

Stock item | Produto de stock | Itens de stock

Available under request (see page A-9) | Disponível sobre consulta (consulte a página A-9) | Disponible bajo consulta (mire pagina A-9)

Insert order code = (1) Geometry Code + (2) Grade Code

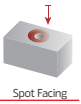

SPARE PARTS | Complementos | Repuestos

Order separately

Cutter ØDc	Insert Screw	Key (Torx)	Key (Torx - Nm)	Torque Value
10-11	P0200400	XT06	DT0606	0,6
13-14	P0220500	XT07	DT0709	0,9
17-18	P0250704	XT08	DT0812	1,2
20-21	P0350702	XT15	DT1530	3,0
25	P0400900	XT15	DT1530	3,0

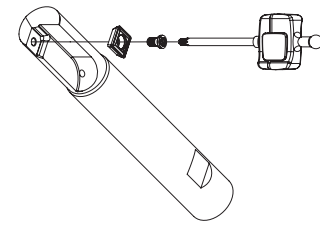

Note: The toolholder is supplied with the XT/PT key. To order the DT key please check the page A-241.
Check the procedures for the clamping screws on the page A-241.

GRADES SELECTION GUIDE | Guia para selecção de graus | Tabla para selección de calidades

ISO	PSM	Material	HB (Brinell)	Grades		
				← Wear Resistance		Toughness →
				PH6920 	PH6930 	PHC930
P	1	Unalloyed Steel	125-220	✓	✓	✓
	2	Low-Alloyed Steel	220-280	✓	✓	✓
	3	High-Alloyed Steel	280-380	✓	✓	✓
M	4	SS - Ferritic / Martensitic	200-330	✓	✓	✓
	5	SS - Austenitic	200-330	✓	✓	✓
	6	SS - Austenitic-ferritic (Duplex)	230-260	✓	✓	✓
K	8	Grey Cast Iron	180-245	✓	✓	✓
	9	Nodular Cast iron	160-250	✓	✓	✓

Good Conditions
 Average Conditions
 Difficult Conditions

RECOMMENDED CUTTING CONDITIONS | Condições de corte recomendadas | Condiciones de corte recomendables

ISO	PSM	Material	HB (Brinell)	Vc (m/min)		
				← Wear Resistance		Toughness →
				PH6920	PH6930	PHC930
P	1	Unalloyed Steel	125-220	180-250	160-240	160-240
	2	Low-Alloyed Steel	220-280	160-220	140-200	140-200
	3	High-Alloyed Steel	280-380	130-180	110-160	110-160
M	4	SS - Ferritic / Martensitic	200-330	170-230	140-210	140-210
	5	SS - Austenitic	200-330	160-200	130-200	130-200
	6	SS - Austenitic-ferritic (Duplex)	230-260	140-180	120-190	120-190
K	8	Grey Cast Iron	180-245	180-250	150-220	150-220
	9	Nodular Cast iron	160-250	130-200	110-180	110-180

ISO	PSM	Material	HB (Brinell)	Feed fz (mm/t)				
				SPKX 05...	SPKX 06...	SPKX 07...	SPKX 09...	SPKX 11...
				P	1	Unalloyed Steel	125-220	0,05-0,08
2	Low-Alloyed Steel	220-280	0,06-0,12		0,08-0,15	0,10-0,18	0,12-0,22	0,12-0,25
3	High-Alloyed Steel	280-380	0,06-0,10		0,08-0,15	0,10-0,20	0,12-0,23	0,12-0,26
M	4	SS - Ferritic / Martensitic	200-330	0,05-0,10	0,06-0,12	0,08-0,15	0,09-0,16	0,10-0,20
	5	SS - Austenitic	200-330	0,04-0,08	0,05-0,10	0,06-0,12	0,07-0,13	0,08-0,18
	6	SS - Austenitic-ferritic (Duplex)	230-260	0,04-0,08	0,05-0,11	0,06-0,13	0,07-0,14	0,08-0,19
K	8	Grey Cast Iron	180-245	0,06-0,12	0,08-0,16	0,12-0,20	0,15-0,25	0,15-0,30
	9	Nodular Cast iron	160-250	0,06-0,10	0,08-0,15	0,10-0,18	0,12-0,20	0,15-0,25

A
MILLING
Overview
Face milling
Hifed milling
Shoulder milling
Profile milling
Hardmill
Center & Chamfer
Spot face
Spare Parts
Technical Data
End Mills

SPARE PARTS

MULTIFIT DENSIMET ANTI-VIBRATION | Shank | Adaptador | Fijación

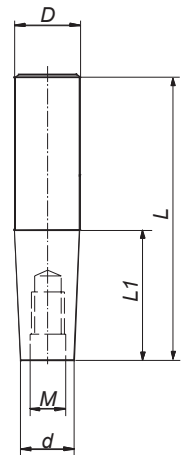

order code	Reference	Dimensions (mm)					Stock
		D	L1	L	d	M	
1191008A0	AC-RI-D12-M06-L040-AV	12	40	90	9,8	M6	⊗
1191009A0	AC-RI-D12-M06-L060-AV	12	60	110	9,8	M6	⊗
1191021A0	AC-RI-D12-M06-L080-AV	12	80	130	9,8	M6	⊗
1191010A0	AC-RI-D16-M08-L040-AV	16	40	95	12,8	M8	⊗
1191011A0	AC-RI-D16-M08-L060-AV	16	60	115	12,8	M8	⊗
1191012A0	AC-RI-D16-M08-L080-AV	16	80	135	12,8	M8	⊗
1191013A0	AC-RI-D16-M08-L100-AV	16	100	155	12,8	M8	⊗
1191022A0	AC-RI-D16-M08-L120-AV	16	120	175	12,8	M8	⊗
1191014A0	AC-RI-D20-M10-L040-AV	20	40	100	15,8	M10	⊗
1191015A0	AC-RI-D20-M10-L060-AV	20	60	120	15,8	M10	⊗
1191016A0	AC-RI-D20-M10-L080-AV	20	80	140	15,8	M10	○
1191017A0	AC-RI-D20-M10-L100-AV	20	100	160	15,8	M10	○
1191018A0	AC-RI-D20-M10-L120-AV	20	120	180	15,8	M10	○
1191026A0	AC-RI-D20-M10-L080-D17,8-AV	20	80	140	17,8	M10	⊗
1191027A0	AC-RI-D20-M10-L100-D17,8-AV	20	100	160	17,8	M10	⊗
1191028A0	AC-RI-D20-M10-L120-D17,8-AV	20	120	180	17,8	M10	⊗
1191023A0	AC-RI-D25-M12-L060-AV	25	60	125	20,8	M12	⊗
1191024A0	AC-RI-D25-M12-L080-AV	25	80	145	20,8	M12	⊗
1191025A0	AC-RI-D25-M12-L100-AV	25	100	165	20,8	M12	⊗

⊗ Stock item | Produto de stock | Itens de stock

○ Available under request | Disponível sobre consulta | Disponible bajo consulta

MULTIFIT CARBIDE ANTI-VIBRATION | Shank | Adaptador | Fijación

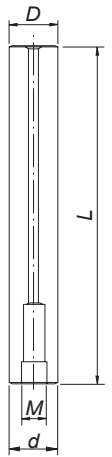

order code	Reference	Dimensions (mm)				Stock
		D	L	d	M	
219102600	AC-RI-D12-M06-L100-HW	12	100	12	M6	☺
219102700	AC-RI-D12-M06-L150-HW	12	150	12	M6	☺
219102800	AC-RI-D16-M08-L100-HW	16	100	16	M8	☺
219102900	AC-RI-D16-M08-L150-HW	16	150	16	M8	☺
219103000	AC-RI-D20-M10-L150-HW	20	150	20	M10	☺
219103100	AC-RI-D20-M10-L200-HW	20	200	20	M10	☺
219103200	AC-RI-D25-M12-L150-HW	25	150	25	M12	☺
219103300	AC-RI-D25-M12-L200-HW	25	200	25	M12	☺
219103400	AC-RI-D32-M16-L250-HW	32	250	32	M16	☺

☺ Stock item | Producto de stock | Itens de stock

○ Available under request | Disponível sobre consulta | Disponible bajo consulta

A

MILLING

Overview

Face milling

Hifeed milling

Shoulder milling

Profile milling

Hardmill

Center & Chamfer

Spot face

Spare Parts

Technical Data

End Mills

SPARE PARTS

A

MULTIFIT CYLINDRICAL IN STEEL | Shank | Adaptador | Fijación

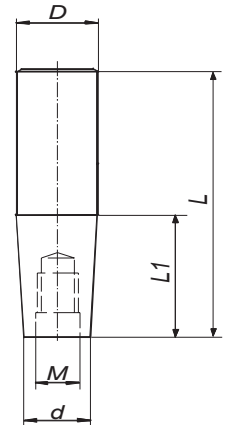

order code	Reference	Dimensions (mm)					Stock
		D	L1	L	d	M	
229000500	AC-RI-D12-M06-L020	12	20	65	9,8	M6	☼
229000600	AC-RI-D16-M08-L040	16	40	88	12,8	M8	☼
229000700	AC-RI-D20-M10-L045	20	45	95	17,8	M10	☼
229000800	AC-RI-D25-M12-L050	25	50	106	20,8	M12	☼
229000900	AC-RI-D32-M16-L050	32	50	110	28,8	M16	☼

☼ Stock item | Produto de stock | Itens de stock

○ Available under request | Disponível sobre consulta | Disponible bajo consulta

MILLING

Overview

Face milling

Hi-feed milling

Shoulder milling

Profile milling

Hardmill

Center & Chamfer

Spot face

Spare Parts

Technical Data

End Mills

MULTIFIT EXTENSIONS FOR THREADED TYPE CUTTER | Shank | Adaptador | Fijación

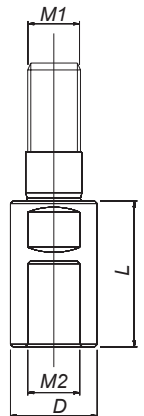

order code	Reference	Dimensions (mm)				Stock
		D	M1	M2	L	
229003200	AL-M08-L040-M08	13,8	M8	M8	40	☼
229003600	AL-M10-L060-M10	18,0	M10	M10	60	☼
229003700	AL-M12-L060-M12	21,0	M12	M12	60	☼
229003100	AL-M16-L060-M16	29,0	M16	M16	60	☼

☼ Stock item | Produto de stock | Itens de stock

○ Available under request | Disponível sobre consulta | Disponible bajo consulta

MULTIFIT REDUCERS FOR THREADED TYPE CUTTER || Shank | Adaptador | Fijación

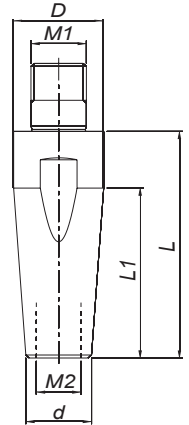

order code	Reference	Dimensions (mm)						Stock
		M1	M2	D	d	L	L1	
229012100	AL-M08-L040-M06	M8	M6	13,8	10,0	40	25	⊗
229012200	AL-M10-L040-M08	M10	M8	18,0	13,8	40	25	⊗
229012300	AL-M12-L040-M10	M12	M10	21,0	18,0	40	15	⊗
229012400	AL-M16-L040-M12	M16	M12	29,0	21,0	40	19	⊗

⊗ Stock item | Produto de stock | Itens de stock

○ Available under request | Disponível sobre consulta | Disponible bajo consulta

A

MILLING

Overview

Face milling

Hifeed milling

Shoulder milling

Profile milling

Hardmill

Center & Chamfer

Spot face

Spare Parts

Technical Data

End Mills

SPARE PARTS

A

SHIM SCREW

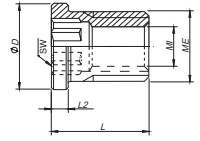

order code	Screw	Dimensions (mm)					
		SW	MI	ME	ØD	L	L2
290030400	T0503509	3,5	M3,5 x 0,6	M5,0 x 0,5	6,3	7	1,2

Overview

Face milling

ADJUSTMENT SCREW

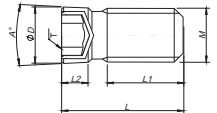

order code	Screw	T (torx)	Dimensions (mm)					
			M	ØD	A°	L	L1	L2
290051500	F0601441	T-20	M6 x 1,0	6,3	5°	13,6	8,5	3,2

Hi-feed milling

Shoulder milling

Profile milling

DIFFERENTIAL SCREW

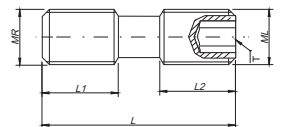

order code	Screw	T (torx)	Dimensions (mm)				
			MR	ML	L	L1	L2
290016300	F0701800	T-20	M7 x 0,75	M7 x 0,75	18	7,5	7,5

Hardmill

Center & Chamfer

Spot face

INSERT SCREW

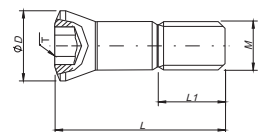

order code	Screw	T (torx)	Dimensions (mm)			
			M	ØD	L	L1
290013900	P0400925	T-15	M4 x 0,5	5,80	8,6	3,5
290010600	P0500925	T-20	M5 x 0,5	6,70	9,5	3,4
290014400	P0501325	T-20	M5 x 0,5	7,50	12,8	4,5
290014000	P0501525	T-20	M5 x 0,5	7,50	15,5	4,5

Spare Parts

Technical Data

End Mills

INSERT SCREW

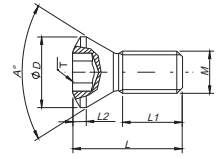

order code	Screw	T (torx)	Dimensions (mm)					
			M	ØD	A°	L	L1	L2
290078800	P0180300	T-GIP	M1,8 x 0,35	2,45	60°	3,4	1,5	0,5
290058400	P0180400	T-GIP	M1,8 x 0,35	2,45	60°	3,7	1,8	0,5
290011300	P0180401	T-6	M1,8 x 0,35	2,75	55°	3,6	1,9	0,4
290031400	P0200500	T-6	M2 x 0,4	2,80	60°	4,7	2,9	0,6
290030600	P0220500	T-7	M2,2 x 0,45	3,20	60°	5,0	3,0	0,6
290033100	P0250503	T-8	M2,5 x 0,45	3,45	60°	5,5	2,8	0,7
290048900	P0250601	T-8	M2,5 x 0,45	3,45	60°	6,0	3,5	0,8
290013400	P0250700	T-8	M2,5 x 0,45	3,3	55	7	4	0,8
290031300	P0250704	T-8	M2,5 x 0,45	3,45	60°	6,5	4,0	0,7
290009100	P0300800	T-9	M3 x 0,5	4,4	60°	7,4	4,2	0,8
290081700	P0350702	T-15	M3,5	5,3	55	7	3,1	2
290019900	P0350800	T-15	M3,5 x 0,6	5,5	60°	7,7	3,7	1
290027100	P0350902	T-10	M3,5 x 0,6	4,7	60°	9	5,5	0,4
290030900	P0350903	T-15	M3,5 x 0,6	5,45	60°	9	6	0,6
290075200	P0350904	T-15	M3,5 x 0,6	4,8	60°	9	5	0,8
290005800	P0351200	T-15	M3,5 x 0,6	5,30	60°	12	8	1,4
119198800	P0400803	T-15	M4 x 0,7	5,5	60°	8	5,5	1
290048200	P0400900	T-15	M4 x 0,7	5,5	60°	9	5,5	1
290075600	P0401065	T-15	M4 x 0,6	5,7	60	10	6	1
290007000	P0401100	T-15	M4 x 0,7	5,3	55	11	8	2
290047500	P0401200	T-15	M4 x 0,7	5,5	60°	11	6	1,2
290026900	P0451001	T-20	M4,5 x 0,75	6,6	55°	10,5	5,5	1
290006700	P0451400	T-20	M4,5 x 0,75	7,2	60°	14	9	1
290017500	P0501100	T-20	M5 x 0,8	6,4	43°	11	5,9	0,5
290031700	P0501300	T-20	M5 x 0,8	7	60°	12,8	8	1,3
290078900	P0501302	T-20	M5 x 0,5	7	60°	13	8,2	0,8
290048300	P0601402	T-20	M6 x 1,0	8,4	60°	14	9	0,9

SPARE PARTS

ADJUSTMENT SCREW

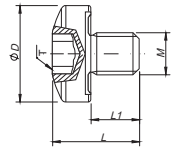

order code	Screw	T (torx)	Dimensions (mm)			
			M	ØD	L	L1
290014200	P0350750	T-15	M3,5 x 0,6	8,00	7,2	4,0

WASHER SCREW

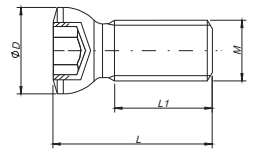

order code	Screw	Dimensions (mm)			
		M	ØD	L	L1
290075600	P0401065	M4 x 0,6	5,7	10,0	6,0
290018500	P0601265	M6 x 1,0	9,00	12,4	6,5
290011000	P0601765	M6 x 1,0	9,00	17,0	11,0
290028400	P0802265	M8 x 1,25	11,0	22,0	15,0

OTHERS

Washer	Order Code	Reference
	119200900	HC01200
	290060200	HC01400
	290002900	HC01800

Cartridge Screw	Order Code	Reference
	119169600	D0602096

Torx Keys	Order Code	Reference
	290058600	XT 06IP
	290011400	XT 06
	290012900	XT07
	290011700	XT 08
	290025700	XT 09
	290013100	XT 10
	290012400	XT 15
	290013200	XT 20
	290014800	PT 15
	290014900	PT 20
	290056000	TT 20
	290059500	LT 30

Shim	Order Code	Reference
	160022218	CS130300
	290060400	CT160300
	290060300	CT220300

Spring Pin	Order Code	Reference
	290060600	BE02500
	290060500	BE04000

Wedge (Insert)	Order Code	Reference
	290060900	WA7001
	290061100	WA7003
	119200100	SETDEV AS 04 00

Wedge (Cartridge)	Order Code	Reference
	290061000	WA7002
	290061200	WA7004

Hex Key	Order Code	Reference
 SS TS	290021200	SS40
	290021300	SS50
	290058700	TS40

Screw for Coolant Supply	Order Code	Reference	M	Ø Ext.
	119163000	J0123510	12	37,9
	119163100	J0164110	16	45,0
	119163200	J0204610	20	54,8

Tork Keys	Order Code	Reference	Torx	Nm
	290078300	DT0606IP	6IP	0,6
	290059600	DT0606	6	0,6
	290059700	DT0709	7	0,9
	290059800	DT0812	8	1,2
	290059900	DT0914	9	1,4
	290060000	DT1020	10	2,0
	290047800	DT1530	15	3,0
	290078400	DT2050	20	5,0

DIN 6368 Wrench	Order Code	Reference
	290058000	SD6368-12
	290058100	SD6368-16
	290058200	SD6368-20

Retaining Screw	Order Code	Reference
	290087700	D1603500
	290087800	D2004000

PROCEDURES FOR CLAMPING SCREWS

1. Always use a torque wrench to ensure that screws are correctly tightened (please confirm torques data on catalogue). Torque that is too high will negatively affect the performance of the tool and can cause screw and insert breakage. Torque that is too low will cause insert movement, vibration and degrade the cutting result. Dedicated adjustable torque wrench can be ordered separately (please see above).

2. Clean the insert seat.
Make sure that the insert seat is free from dust or chips from the machining. If necessary, clean the insert seat with compressed air.

3. Check the insert seat.
Before assembly cutter it is important to ensure that the insert seat has not been damaged during machining or handling.

4. Apply sufficient screw lubrication to prevent seizure. Lubricant should be applied to the screw threads as well as to the screw head face.

5. Replace worn or damaged screws.

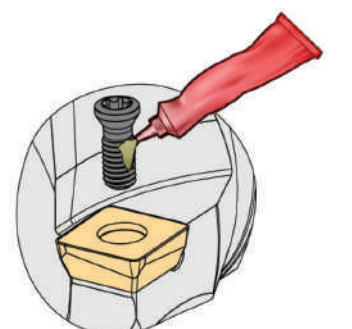
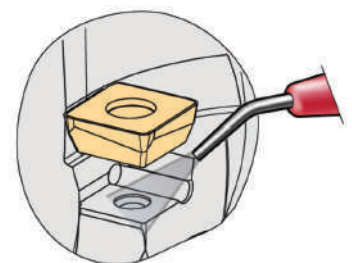

MILLING GRADES

A	1	5	10	15	20	25	30	35	40	45	50				
MILLING	P STEEL		PHP910									PVD			
			PH7910										CVD		
				PHP920											
				PH7920											
						PHP930									
						PH7930									
							PHP530								
								PHP808							
								PH7740							
								PHS740							
Overview	M STAINLESS STEEL					PHH930						PVD			
						PH7930									
							PHH530								
							PHP530								
								PHH808							
								PH7740							
Face milling	K CAST IRON		PHP910									PVD			
			PH7910										CVD		
				PHP920											
				PH7920											
						PHP930									
						PH7930									
								PH7740							
				PH5705											
				PH5320											
								PH5740							
Hi-feed milling	K CAST IRON											CVD			
Shoulder milling	K CAST IRON											CVD			
Profile milling	K CAST IRON											CVD			
Hardmill	K CAST IRON											CVD			
Center & Chamfer	K CAST IRON											CVD			
Spot face	K CAST IRON											CVD			
Spare Parts	K CAST IRON											CVD			
Technical Data	K CAST IRON											CVD			
End Mills	K CAST IRON											CVD			

	1	5	10	15	20	25	30	35	40	45	50	
N ALUMINIUM & NFM	PH0910											UNCOTED
		PHD103										CVD
		PDP403										PCD
		PDP410										
S HEAT RESISTENT / TITANIUM ALLOYS							PHH930					PVD
							PH7930					
							PHH530					
								PHH808				
								PH7740				
H HARDENED MATERIALS			PHH603									PVD
				PH7603								
					PHH910							
		PBH920										PCBN

A

MILLING

Overview

Face milling

Hifeed milling

Shoulder milling

Profile milling

Hardmill

Center & Chamfer

Spot face

Spare Parts

Technical Data

End Mills

MILLING GRADES

A
MILLING
Overview
Face milling
Hi-feed milling
Shoulder milling
Profile milling
Hardmill
Center & Chamfer
Spot face
Spare Parts
Technical Data
End Mills

PVD GRADES

PHP...

Product of the latest coating technology, the new PHP coating comes to revolutionize the milling of Steel and Cast Iron. PHP is a balanced PVD coating that combines high hardness and high cracking resistance. It's composition and structure ensure an optimal adhesion which results in a very smooth surface preventing built-up edge, coating worn-out and keeps the insert in a lubricated-like condition.

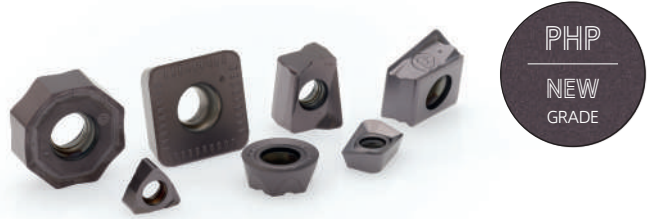

WEAR RESISTANCE

TOUGHNESS

PHP910 P05-P10 K05-K10 Recommended for light operations in steels.	PHP920 P10-P35 K10-K30 Recommended for General Steel & Cast Iron Milling.	PHP930 P20-P40 K20-K40 Recommended for medium to roughing operations in steels and cast irons.	PHP530 P25-P40 M25-M40 Extremely heat resistant grade. First choice in cold-section turbine blade milling.	PHP808 P30-P40 High heat resistance grade. Economic choice for cold-section turbine blade milling.
--	---	--	--	---

PHH...

Product of the latest coating technology, the new PHH coating comes to revolutionize the milling of stainless steel, HRSA as well and hardened steel. PHH is a stable PVD coating that merges both high hardness and an unmatched heat resistance. It's structure contains refractory materials which allows it to work at the highest temperature and the hardest conditions.

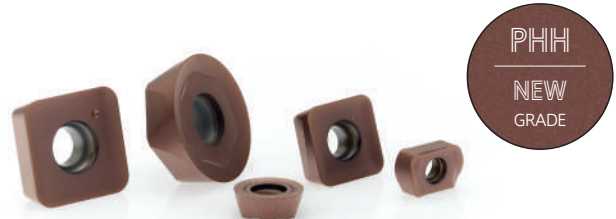

WEAR RESISTANCE

TOUGHNESS

PHH603 H05-H15 P01-P05 Recommended for finishing operations in steels and hardened steels. First choice in mold and die finishing applications.	PHH910 P05-P10 H15-H30 Recommended for finishing operations in steels and hardened steels in unstable conditions.	PHH930 M20-M40 S20-S30 Recommended for general purpose milling of stainless steels and HRSA.	PHH530 M25-M40 S25-S35 Extremely heat resistant grade. First choice in hot-section turbine blade milling.	PHH808 M30-M40 S30-S40 High heat resistance grade. Economic choice in hot-section turbine blade milling.
---	---	--	---	--

PH7... | PH6...

A medium thickness PVD coating with good compatibility with steels, stainless steels, cast irons and HRSA.

WEAR RESISTANCE

TOUGHNESS

PH7603 (PH6103) H01-H20	PH7910 (PH6910) P05-P10 K05-K10	PH7920 (PH6920) P10-P35 K10-K30	PH7930 (PH6930) P20-P40 M20-M30 K20-K40 S25-S35	PH7740 (PH6740) P30-P50 M30-M50 K30-K40 S30-S40
--------------------------------------	---	---	---	---

Note: PH6... grades are very similar to PH7... The difference being that PH7 is mostly used in proprietary milling lines while PH6... is used on interchangeable inserts.

CVD GRADES

PHS740...

A tough substrate combined with a thin CVD coating with excellent thermal resistance and hardness at high temperature. 1st choice solution for removal of oxide layer from workpiece surface and for unstable conditions where a lot of heat is generated (ex: heavy duty applications).



PH5...

A thick CVD coating with very smooth surface. Can be used wet or dry. Ideal for machining cast irons.

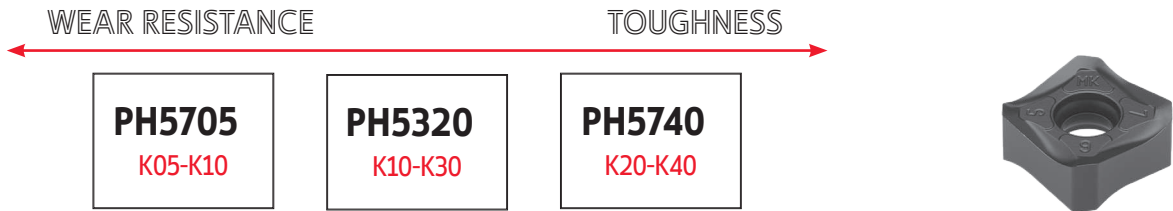

PHD103

A carbide substrate with high abrasion resistance coated with crystalline diamond CVD coating. Ideal for graphite machining.

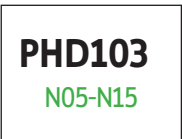

PH0910

Uncoated carbide micro-grain grade combining a good abrasive wear resistance and toughness. Suitable for rough to finish operations of aluminum alloys.



PCBN

PBH920

Carbide insert with Polycrystalline Cubic Boron Nitride tip for finishing operations on hardened steels.

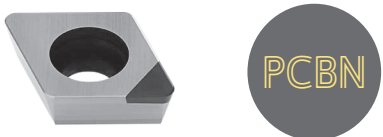
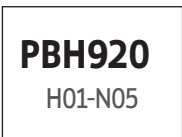

PCD

PDP4...

Carbide insert with Polycrystalline Diamond tip for finishing operations on aluminums and non-ferrous metallic materials.



A

MILLING

Overview

Face milling

Hi-feed milling

Shoulder milling

Profile milling

Hardmill

Center & Chamfer

Spot face

Spare Parts

Technical Data

End Mills

COMPARATIVE GRADES CHART

PVD COATED GRADES | GRAUS REVESTIDOS A PVD | GRADOS CON RECUBRIMIENTO PVD

ISO	Material	Palbit	Sandvik	Kennametal	Iscar	Seco	Mitsubishi	Sumitomo	Hitachi	Walter	Kyocera	Taegutec	Dijet	Ceratizit
STEEL	P01	PH7603 PH6103	GC1010	KC505M KC510M KC515M	IC903				ATH80D JP4105			TT2510 TT5505	JC8003	
	P10	PH7910 PH6910 PH9P910	GC1010 GC1025	KC505M KC510M KC515M KC610M KC715M	IC903 IC907 IC950 IC908 IC910 IC380 IC380 IC900	CP200 TS2001	MP6120 VP15TF	ACP200	ATH80D PN08M ATH10E PN15M JP4105 JP4115 JP4120	WHH15 WXM15	PR830 PR1225 PR1230 PR1525	TT2510 TT5505 TT5515 TT7080	JC8003 JC8015 JC5015 JC5118	
	P20	PH7920 PH6920 PH6125 PH9P920	GC1025 GC1030 GC2030	KC522M KC525M KC527M KC530M KC610M KC620M KC635M KC715M KC720M KC730M	IC907 IC950 IC908 IC910 IC380 IC900 IC830 IC928 IC1008	CP250 TS2500	MP6120 VP15TF MP6130 UP20M VP20RT	ACP200 ACP300	JP4120 JS4045 CY250	WHH15 WXM15	PR830 PR1225 PR1230 PR1525	TT2510 TT5505 TT5525 TT7080 TT9030 TT9080	JC8015 JC5015 JC5118 JC5040	CTP1235 CTP1625
	P30	PH808 PH530 PH7930 PH6930 PH6135 PH9P930	GC1025 GC1125	KC525M KC527M KC530M KC537M KC610M KC620M KC720M KC725M KC730M KC735M	IC907 IC950 IC908 IC910 IC380 IC900 IC830 IC928 IC1008	MP3000 F25M F30M F40M	MP6120 VP15TF MP6130 UP20M VP20RT VP30RT	ACP200 ACP300	JS4045 CY250 JM4160	WSP45 WSP46	PR830 PR1225 PR1230 PR1525	TT5525 TT7080 TT8020 TT8080 TT9030 TT9080	JC5118 JC5040 JC8050 JC7560	CTP1235 CTP1625 CTP2235
	P40	PH7740 PH6740		KC537M KC720M KC725M KC735M	IC830 IC928 IC1008	MP3000 F40M T60M	VP30RT	ACP300	JM4160	WSP45 WSP46		TT8020	JC5118 JC5040 JC8050 JC7560	CTP1235 CTP2235
	M01		GC1010			IC907 IC903			ACM100 ACK300	PCS08M				
M10	PH7910 PH6910	GC1010 GC1025 GC1030 GC2030	KC515M KC610M KC635M KC720M	IC907 IC903		VP15TF		ACM100 ACK300 ACP300	PCS08M CY150	WXM15	PR830 PR1225 PR1525 PR1535			
M20	PH7920 PH6920	GC1025 GC1030 GC1040 GC2030	KC522M KC525M KC530M KC610M KC635M KC720M KC730M	IC380 IC900 IC908 IC928 IC1008	MP3000 MS2050 F25M F30M	VP15TF MP7130 MP7030 UP20M VP20RT	ACM300 ACP300	CY150 CY250	WXM15 WSM35 WSM36	PR830 PR1225 PR1525 PR1535	TT8020 TT8080	JC8015 JC5015 JC5118	CTP1235 CTP1625	
M30	PH7930 PH6930 PH6135 PHH530 PHH930	GC1040 GC2030	KC522M KC525M KC530M KC537M KC725M KC730M KC735M	IC380 IC900 IC908 IC928 IC1008 IC328 IC330	MP3000 MS2050 F30M F40M	VP15TF MP7130 MP7030 UP20M VP20RT MP7140 VP30RT	ACM300	CY250 JM4160	WSM35 WSM36 WSP45 WSP46	PR830 PR1225 PR1525 PR1535	TT8020 TT8080	JC8015 JC5015 JC5118 JC8050 JC7560	CTP1235 CTP2235	
M40	PH7740 PH6740 PHH808	GC1040	KC725M	IC1008 IC328 IC330	MS2050 F40M	MP7140 VP30RT	ACM300	JM4160	WSM35 WSM36 WSP45 WSP46	PR1225 PR1525 PR1535	TT8020	JC5015 JC5118 JC8050 JC7560	CTP2235	
CAST IRON	K01		GC1010		IC380 IC900		MP8010		ATH80D JP4105		PR1510	TT6080	JC8003	AMZ
	K10	PH7910 PH6910 PH9P910	GC1010 GC1020	KC514M KC515M KC520M KC620M	IC380 IC900 IC810 IC910	MK2050	MP8010 VP15TF		ATH80D JP4105 JP4120 CY150	WHH15 WXM15 WKK25	PR1210 PR1510	TT6080	JC8015	AMZ CTP3220 CTP6215
	K20	PH9P920 PH7920 PH6920	GC1020	KC514M KC520M KC522M KC524M KC527M KC610M KC620M KC635M	IC810 IC910 IC950 IC350 IC830 IC928	MK2050	MP8010 VP15TF VP20RT	ACK300	JP4120 CY150 CY250	WHH15 WXM15 WKK25	PR1210 PR1510		JC8015 JC5015	CTP3220 CTP1625
	K30	PH7740 PH6740		KC522M KC524M KC527M KC537M KC610M KC620M KC635M	IC830 IC928 IC1008 IC808 IC908	MK2050	VP15TF VP20RT	ACK300	CY250	WKK25	PR1510		JC8015 JC5015	

PVD COATED GRADES | GRAUS REVESTIDOS A PVD | GRADOS CON RECUBRIMIENTO PVD

ISO		Palbit	Sandvik	Kennametal	Iscar	Seco	Mitsubishi	Sumitomo	Hitachi	Walter	Kyocera	Taegutec	Dijet	Ceratzit
Material														
ALUMINIUM	N01			KC410M KC510M KC5410								TT6080		AMZ
	N10		GC1025 GC1030	KC410M KC510M KC5410 KC620M				DL1000	SD5010 HD7010	WXN15		TT6080 TT8020		AMZ
	N20		GC1025 GC1030	KC422M KC620M		F15M	LC15TF	DL1000	SD5010 HD7010	WXN15		TT8020		
HEAT RESISTENT / TITANIUM ALLOYS	S01		GC1010	KC510M	IC808 IC907 IC908			ACM100 ACK300			PR905 PR1210 PR1535		JC8003 JC8015	AMZ
	S10	PH7910 PH6910	GC1010 GC1030 GC2030	KC510M KC610M	IC808 IC907 IC908 IC903	MS2050	MP9120 VP15TF MP9130 MP9030	ACM100 ACK300	PTH135 JS1025		PR905 PR1210 PR1535	TT9030 TT9080 TT8080	JC8003 JC8015 JC5015 JC5118	AMZ CTP1625
	S20	PH7920 PH6920	GC1030 GC1040 GC2030 GC2040	KC522M KC525M KC610M	IC300 IC900 IC830 IC928	MS2050 F40M	MP9120 VP15TF MP9130 MP9030	ACM300	PTH135 JS1025	WSM35 WSM36	PR905 PR1210 PR1535	TT8080 TT8020	JC8015 JC5015 JC5118 JC8050 JC7560	CTP1235 CTP1625
	S30	PH7930 PH6930 PHH930 PHH530	S30T GC1040 GC2040	KC522M KC525M KC725M	IC830 IC928	MS2050 F40M	MP9130 MP9030	ACM300		WSM35 WSM36 WSP45 WSP46	PR1535	TT8020	JC5118 JC8050 JC7560	CTP1235 CTP2235
	S40	PH7740 PH6740 PHH808	GC2040 GC1040	KC725M	IC830 IC928	MS2050 F40M				WSP45 WSP46			JC5118 JC8050 JC7560	
HARDENED MATERIAL	H01	PH7603 PH6103 PHH603	GC1010	KC510M	IC903		MP8010					TT2510 TT5505	DH102 JC6102 JC8003 JC8008	
	H10	PHH603 PH7603 PH6103 PH7910 PHH910	GC1010 GC1025 GC1030	KC505M KC510M KC635M	IC903 IC808 IC907 IC908	MH1000 F15M	MP8010 VP15TF		PTH08M JP4105	WHH15		TT5515 TT6080	JC6102 JC8003 JC8015 JC5118	CTP6215
	H20		GC1025 GC1030	KC635M	IC808 IC907 IC908 IC380 IC900	F15M	VP15TF		JP4105	WHH15		TT5515 TT6080	JC8015 JC5118	CTP6215
	K10				IC380 IC900 IC1008	MP3000 F30M								

A
MILLING
Overview
Face milling
Hifed milling
Shoulder milling
Profile milling
Hardmill
Center & Chamfer
Spot face
Spare Parts
Technical Data
End Mills

COMPARATIVE GRADES CHART

CVD COATED GRADES | GRAUS REVESTIDOS A CVD | GRADOS CON RECUBRIMIENTO CVD

ISO	Material	Palbit	Sandvik	Kennametal	Iscar	Seco	Mitsubishi	Sumitomo	Hitachi	Walter	Kyocera	Taegutec	Dijet	Ceratzit	
STEEL	P40	PH5740				MP2500				WKP355					
	M	M10		GC2015	KCPM20	IC9250 IC520M IC9350		ACM200					JC730U		
		M20		GC4230	KCPM20 KCPM30 KC927M	IC9250 IC520M IC9350 IC4050 IC635	MP2500 T350M T25M	F7030	ACM200		CA6535	TT7800	JC730U	CTC5235 GM226+	
		M30		GC2040 GC4230 GC4240 S40T	KCPM30 KC927M	IC9350 IC4050 IC635	MP2500 T350M T25M	F7030	ACM200	GX2160	CA6535	TT7800	JC730U	CTC5235 CTC5240 GM226+ GM246 GM43+	
M40			GC2040 GC4240 S40T		IC635	In4500 T350M			GX2160	CA6535			CTC5235 CTC5240 GM246 GM43+		
STAINLESS STEEL	K	K01	PH5705		KC907M	IC8080 IC4100 IC5100 IC9150		MC5020	ACK200		WKP15	CA420M	JC605W	CTC3215	
		K10	PH5705	GC3220	KC907M KC914M KC917M KC924M KCK15	IC8080 IC4100 IC5100 IC9150 IC9080 IC520M	MK1500	MC5020	ACK200	GX2120	WKP15 WKP25	CA420M	TT6800	JC605W JC608X JC610	CTC3215 SR216 SR226+
		K20	PH5320	GC3220 GC3330 GC3040 GC4220 GC4230	KC917M KC924M KCK15 KCPM20 KCPK30 KC927M	IC5100 IC9150 IC9080 IC520M IC4050	MK1500 MP1500	MC5020	ACK200	GX2120 GX2140	WKP15 WKP25 WKP35 WKP355	CA420M	TT6800	JC605W JC608X JC610	SR216 SR226+
		K30	PH5740	GC3330 GC3040 GC4220 GC4230 GC4240	KCPM20 KCPK30 KC927M	IC520M IC4050	MK1500 MP1500	MC5020		GX2140	WKP25 WKP35 WKP355			JC610	
CAST IRON															

UNCOATED GRADES | GRAUS NÃO REVESTIDOS | GRADOS SÍN RECUBRIMIENTO

ISO		Palbit	Sandvik	Kennametal	Iscar	Seco	Mitsubishi	Sumitomo	Hitachi	Walter	Kyocera	Taegutec	Dijet	Ceratzit
Material														
ALUMINIUM	N01	PH0910	H10	K115M KC313	IC20		HTi 10	H1 G10E	PCS08M CY100H		PCS08M CY100H			H210T
	N10	PH0910	H13A H10F	K115M KC313	IC08	H15	HTi 10	H1 G10E	PCS08M CY100H CY10H	WK10	PCS08M CY100H CY10H	K10 UF10		H210T
	N20	PH0910	H13A H10F	K125M	IC08 IC28	HX H15 H25	HTi 10					K10		H216T

A

MILLING

Overview

Face milling

Hifeed milling

Shoulder milling

Profile milling

Hardmill

Center & Chamfer

Spot face

Spare Parts

Technical Data

End Mills

CUTTING DATA CALCULATION

Cálculo de condições de corte | Cálculo de datos de corte

Formulas

Spindle Speed (rev/min)

$$n = \frac{v_c \cdot 1000}{\pi \cdot D_c}$$

Cutting Speed (m/min)

$$v_c = \frac{n \cdot \pi \cdot D_c}{1000}$$

Feed Speed (mm/min)

$$v_f = n \cdot Z_n \cdot f_z$$

Feed per Tooth (mm/tooth)

$$f_z = \frac{v_f}{n \cdot Z_n}$$

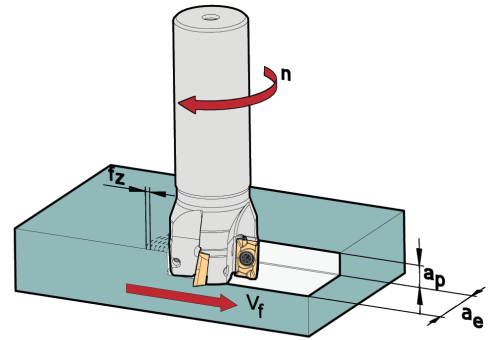

Feed per Revolution (mm/rev)

$$f = Z_n \cdot f_z$$

Metal removal Rate (cm³/min)

$$Q = \frac{a_e \cdot a_p \cdot v_f}{1000}$$

Cutting Speed and Spindle Speed for Copying

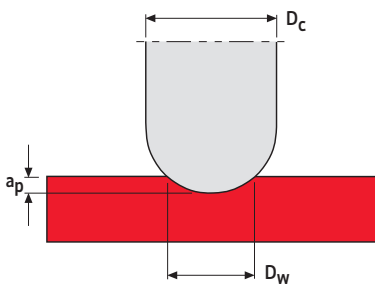

$$v_c = \frac{n \cdot \pi \cdot D_w}{1000} \quad (\text{m/min})$$

$$n = \frac{v_c \cdot 1000}{\pi \cdot D_w} \quad (\text{RPM})$$

$$D_w = 2 \cdot \sqrt{a_p (D_c - a_p)} \quad (\text{mm})$$

Nomenclature

- a_e - Width of cut mm/radial depth of cut (mm)
- a_p - Depth of cut mm/radial depth of cut (mm)
- D_c - Cutter diameter (mm)
- D_w - Effective diameter in cut (mm)
- f - Feed per Revolution (mm/rev)
- f_z - Feed per Tooth (mm/tooth)
- n - Spindle Speed (rev/min)
- Q - Material removal Rate (cm³/min)
- v_c - Cutting Speed (m/min)
- v_f - Feed Speed (mm/min)
- Z_n - N° of teeth

POWER REQUIREMENT CALCULATION

Cálculo de potência requerida | Cálculo del requerimiento de potencia

Calculating the power demand

$$P_C = \frac{a_p \times a_e \times v_f}{6000000 \times \eta} \times k_C$$

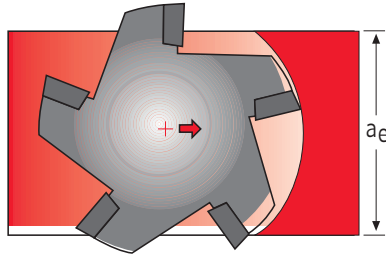

- P_C - Power (kW)
- a_p - Depth of cut (mm)
- a_e - Width of cut (mm)
- v_f - Feed speed (mm/min)
- η - Efficiency
- k_C - Cutting force per mm²

Calculating average chip thickness (h_m) and cutting force per mm² (k_C)

$$h_m = \frac{360 \times f_z \times a_e}{\pi \times D_C \times \omega_e} \times \sin k_r$$

- h_m - Average chip thickness (mm)
- f_z - Feed per tooth (mm/tooth)
- D_C - Cutter diameter (mm)
- ω_e - Engagement angle
- k_r - Lead angle

$$k_C = \frac{1}{h_m^{m_C^*}} \times k_{C^*}$$

- m_C^* - Exponent
- k_{C^*} - Cutting force for 1 mm chip thickness (N/mm²)

* Please see these values on page 797.

Engagement angle

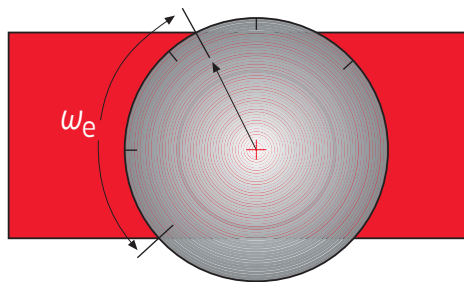

Engagement a_e / D_C	Engagement angle ω_e
70%	89°
100%	180°

Engagement a_e / D_C	Engagement angle ω_e
5%	26°
10%	37°
75%	60°

Coarse Pitch Type	Normal Pitch Type	Fine Pitch Type
<p>First choice for cutting aluminium (long-chipping material - ISO N). First choice for unstable operations due to lowest cutting forces. Smooth cutting allows longer overhang applications. First choice for deep cutting and high feed rates.</p>	<p>First choice for roughing in stable conditions. Good productivity. Good chip space for roughing in steels, stainless steel and super alloys. First choice for shallow cutting with low feed rates.</p>	<p>First choice for cast iron. First choice for high productivity with low width of cut (A_e). Roughing in super alloys materials in combination with round inserts. For cutting operations where chip discharge volume is small and high table feed is desired.</p>

Standard inserts

Positive and Negative Rake Angle

- Insert shape whose cutting edge precedes is a positive rake angle.
- Insert shape whose cutting edge follows is a negative rake angle.

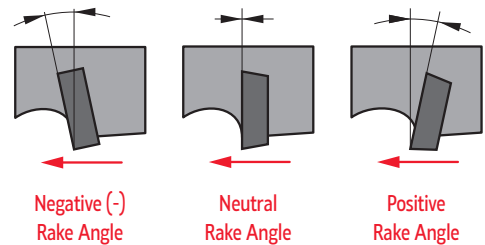

Standard Cutting Edge Shape

Standard Cutting Edge Combinations	(+) Axial Rake Angle	(-) Axial Rake Angle	(+) Axial Rake Angle
	Double Positive (DP Edge Type)	Double Negative (DN Edge Type)	Negative / Positive (NP Edge Type)
Axial Rake Angle γ_p	Positive (+)	Negative (-)	Positive (+)
Radial Rake Angle γ_f	Positive (+)	Negative (-)	Negative (-)
Insert Used	Positive Insert (One Sided Use)	Negative Insert (Double Sided Use)	Positive Insert (One Sided Use)
Work Material	Steel	-	
	Cast Iron	-	
	Aluminium Alloy		-
	Hardened Materials		-

Choosing Cutter Diameter

The Best Cutter Diameter ($\varnothing D_c$) should be selected upon the workpiece dimensions

$$D_c = 1,3 - 1,5 a_e$$

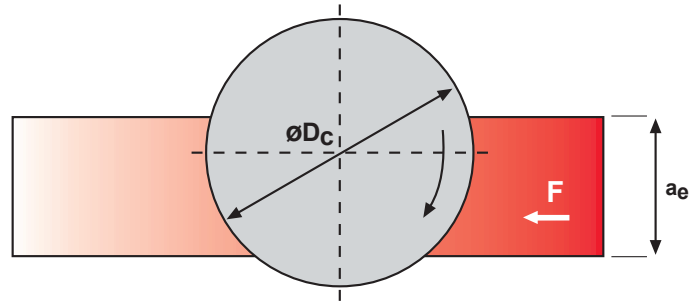

If the machine power is limited or the workpiece is too wide, select a cutter diameter that takes more than two passes or that matches the power of machine. When the appropriate cutter diameter is not available, proper cutter position will give good results.

$$a_e = 3/4 D_c$$

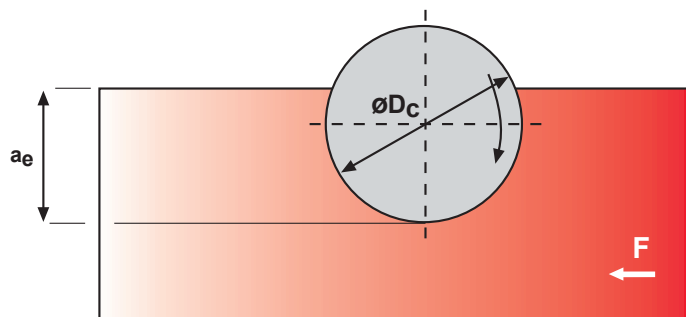

Cutter Position

Conventional Milling (Up Milling)

The feed direction of the workpiece is opposite to that of cutter rotation. The chip thickness starts at zero and increases to the maximum at the end of cut. In Up Milling, the insert wear is severe with excessive friction and high temperature caused by the rubbing or burnishing effect in the insert.

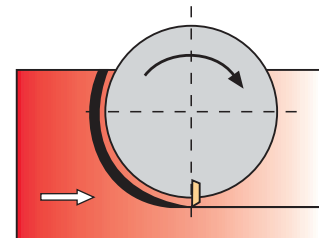

Channel Milling (Up and Down Milling)

The cutter position is in the middle of the workpiece and the cutting force is alternately changed in the radial direction. It causes vibration when the spindle structure is weak. Channel Milling is a combination of conventional and climb milling. When Channel Milling is necessary use positive geometry cutters at reduced speeds and feeds with coolant.

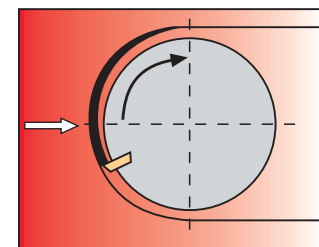

Climb Milling (Down Milling)

Climb Milling is normally recommended. The feed direction of workpiece is the same as that of cutter rotation. So the chip thickness starts from the maximum and decreases to zero at the end of cut. The tool life is long with less heat and minimum work hardening of workpiece.

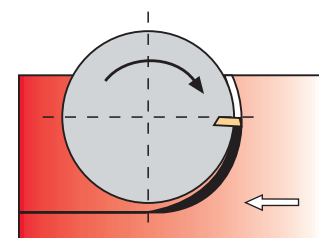

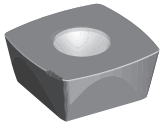

EDGE WEAR

Corrective action:

- Increase feed rate
- Reduce cutting speed
- Use more wear resistant grade
- Apply coated grade

DESGASTE DA ARESTA

Possível solução:

- Aumentar o avanço
- Reduzir a Vc
- Usar grau mais resistente ao desgaste
- Aplicar grau revestido

DESGASTE DEL FLANCO

Solución posible:

- Aumentar el avance
- Reduzca la velocidad de corte
- Seleccione una calidade más resistente al desgaste
- Utilice metales duros recubiertos



HEAT DEFORMATION (UPSET)

Corrective action:

- Reduce cutting speed
- Reduce feed
- Reduce depth of cut
- Use grade with higher hot hardness

DEFORMAÇÃO ARESTA

Possível solução:

- Reduzir a Vc
- Reduzir o avanço
- Reduzir a profundidade corte
- Usar grau com maior dureza a quente

DEFORMACIÓN PLÁSTICA

Solución posible:

- Reduzca la velocidad de corte
- Seleccione una calidade más resistente al desgaste
- Reduzca el ap



THERMAL CRACKING

Corrective action:

- Properly apply coolant
- Reduce cutting speed
- Reduce feed
- Apply coated grade

FENDAS TÉRMICAS

Possível solução:

- Aplicação correcta do fluido de corte
- Reduzir a Vc
- Reduzir o avanço
- Aplicar grau revestido

FISSURAS TÉRMICAS

Solución posible:

- Preste atención al uso del refrigerante
- Reduzca la velocidad de corte
- Reduzca el avance
- Utilice metales duros recubiertos

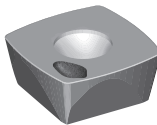

CRATER

Corrective action:

- Reduce feed rate
- Reduce speed
- Apply coated grades
- Apply coolant

CRATERA FACE ATAQUE

Possível solução:

- Reduzir o avanço
- Reduzir a Vc
- Aplicar grau revestido
- Usar fluido de corte

DESGASTE DE CRÁTER

Solución posible:

- Reduzca el avance
- Reduzca la velocidad de corte
- Utilice metales duros recubiertos
- Preste atención al uso del refrigerante

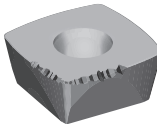

CHIPPING

Corrective action:

- Use a tougher grade
- Consider edge preparation
- Check rigidity of system
- Increase lead angle

ESMILHAMENTO

Possível solução:

- Usar um grau mais tenaz
- Considerar a preparação da aresta
- Verificar a rigidez do sistema
- Aumentar o ângulo de ataque

FILOS ASTILLADOS

Solución posible:

- Seleccione una calidade más resistente al desgaste
- Utilice un inserto con una geometria de filo de corte más estable
- Modifique el ángulo de posicion
- Modifique la geometria de rompevirutas

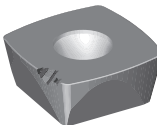

DEPTH-OF-CUT NOTCHING

Corrective action:

- Change lead angle
- Consider edge preparation
- Apply different grade
- Adjust feed

FRACTURA

Possível solução:

- Alterar o ângulo de ataque
- Considerar a preparação da aresta
- Aplicar outro grau
- Ajustar o avanço

DESGASTE POR ENTALLA

Solución posible:

- Escoja un ángulo de posición mas pequeño
- Ajuste el avance
- Cambie de calidad
- Utilice un inserto con una geometria de filo de corte más estable

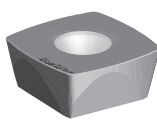

BUILT-UP EDGE

Corrective action:

- Increase cutting speed
- Increase feed rate
- Apply PVD coated grades
- Use coolant
- Edge preparation (smaller hone)

ARESTA POSTIÇA CORTE

Possível solução:

- Aumentar a Vc
- Aumentar o avanço
- Aplicar grau revestido
- Usar fluido de corte
- Reduzir boleamento

FILOS RECRECIDOS

Solución posible:

- Aumentar la velocidad de corte
- Aumentar el avance
- Utilice metales duros recubiertos
- Aplique refrigerante con mayor concentración de aceite
- Seleccione una geometria de corte positiva

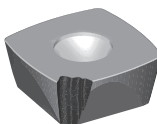

CATASTROPHIC BREAKAGE

Corrective action:

- Utilize stronger grade / geometry
- Reduce feed rate
- Reduce depth of cut
- Check rigidity of system
- Examine edge prep / nose radius

FRACTURA CATASTRÓFICA

Possível solução:

- Aplicar grau / geometria mais resistente
- Reduzir o avanço
- Reduzir a profundidade de corte
- Aplicar grau revestido
- Usar fluido de corte

ROTURA DE INSERTO

Solución posible:

- Seleccione un material más tenaz
- Utilice insertos más robustos con ángulos de arista más grandes
- Seleccione una geometria de rompe virutas para secciones de corte más amplias
- Reduzca en avance

PROBLEMS PROBLEMAS PROBLEMAS	Possible causes and areas of investigation Causas possíveis e áreas de intervenção Posibles causas y las áreas de intervención	cutting speed velocidade de corte velocidad corte	feed avanço avance	depth-of-cut profundidade de corte profundidad de corte	grate grau da pastilha calidad inserto	coolant óleo de corte refrigerante	rake angle ângulo de ataque ángulo de posición	edge preparation preparação da aresta preparación del filo	material (type / condition) material (tipo / condições) material	center height altura do centro altura al centro	geometry (insert) geometria da pastilha geometria del inserto	insert finish acabamento na pastilha acabado del inserto	insert thickness espessura da pastilha espesura inserto	nose radius raio de canto radio punta	lead angle ângulo da aresta de ataque ángulo filo corte	holder (type / condition) suporte (tipo / condições) soporte (condiciones)	machine condition estado do equipamento - torno condición de maquina	chip flow direction direcção de fluxo da aparã dirección de la viruta	horsepower potência fuerza	excessive overhang excesso comprimento livre da ferramenta sobreendeudamiento excesivo	spindle bearings rolamentos do eixo cojinetes del husillo	turret torreta torreta	machine anchored fundações da máquina anclada de la maquina	workholding fixação da peça sujeción pieza	rigidity rigidez / estabilidad	chatter vibração vibraciones
		cutting speed velocidade de corte velocidad corte	feed avanço avance	depth-of-cut profundidade de corte profundidad de corte	grate grau da pastilha calidad inserto	coolant óleo de corte refrigerante	rake angle ângulo de ataque ángulo de posición	edge preparation preparação da aresta preparación del filo	material (type / condition) material (tipo / condições) material	center height altura do centro altura al centro	geometry (insert) geometria da pastilha geometria del inserto	insert finish acabamento na pastilha acabado del inserto	insert thickness espessura da pastilha espesura inserto	nose radius raio de canto radio punta	lead angle ângulo da aresta de ataque ángulo filo corte	holder (type / condition) suporte (tipo / condições) soporte (condiciones)	machine condition estado do equipamento - torno condición de maquina	chip flow direction direcção de fluxo da aparã dirección de la viruta	horsepower potência fuerza	excessive overhang excesso comprimento livre da ferramenta sobreendeudamiento excesivo	spindle bearings rolamentos do eixo cojinetes del husillo	turret torreta torreta	machine anchored fundações da máquina anclada de la maquina	workholding fixação da peça sujeción pieza	rigidity rigidez / estabilidad	chatter vibração vibraciones
• UNACCEPTABLE CHIPS • APARA DESADEQUADA • VIRUTA INACEPTABLE	• stringer / ribbons (light silver color) • demasiado longas (cor de prata suave) • mucho larga (color plata suave)	P↑	P↑	⊗	⊗	⊗	⊗	⊗	⊗		P			⊗	⊗											
	• scorrugated / tight (dark blue or black color) • ondulado / firme (cor azul escuro ou preto) • corrugado / firme (azul / negra)	⊗	P↓	⊗	⊗	⊗	⊗	⊗	⊗		P			⊗	⊗											
• WORKEPIECE CONCERNS • MATERIAL • MATERIAL	• finish / rms tolerance • tolerância e rugosidades • tolerancia y rugosidades	P	P	⊗	⊗	⊗	⊗	⊗	⊗	⊗		⊗		P			⊗	⊗								
	• interrupted cuts • corte interrompido • corte interrumpido	P↑	P↓	P↓	⊗	⊗	⊗	⊗	⊗		⊗	⊗	⊗	⊗	▲		⊗	⊗	⊗	⊗	⊗		⊗	⊗	⊗	⊗
• MACHINE CONCERNS • MÁQUINA FERRAMENTA • MÁQUINA HERRAMIENTA	• areas of investigation • áreas de intervenção • áreas de intervención	⊗	⊗	⊗	⊗	⊗				⊗							⊗		⊗	⊗	⊗	⊗	⊗	⊗	P	
	• edge wear • desgaste da aresta • desgaste de flanco	P	P	⊗	P	⊗				⊗																
• INSERTS FAILURE MODES • MODOS DE RUPTURA DA PASTILHA • MODOS DE RUPTURA DE INSERTO	• heat deformation (upset) • deformação plástica • deformación plástica	P↓	P↓	P↓	⊗	⊗	⊗					⊗	⊗													
	• thermal cracking • fendas térmicas • fissuras térmicas	⊗	⊗	⊗	P	P	⊗					⊗														
• INSERTS FAILURE MODES • MODOS DE RUPTURA DA PASTILHA • MODOS DE RUPTURA DE INSERTO	• crater • cratera na face de ataque • crater en la pared de ataque	P↓	P↓		⊗	⊗	⊗			⊗							⊗									
	• chipping • esmialhamento • filos astillados	⊗	⊗		P	⊗	⊗	P	⊗	⊗	⊗	⊗	⊗	⊗	⊗	⊗						⊗	⊗	⊗		
• INSERTS FAILURE MODES • MODOS DE RUPTURA DA PASTILHA • MODOS DE RUPTURA DE INSERTO	• depth-of-cut notching • fractura • desgaste por entalla	⊗	⊗		⊗	⊗	⊗	P	⊗			⊗	P													
	• built-up edge • aresta postiça de corte • filos recrescidos	P↑	P↑		PVD	⊗	⊗	P	P	⊗	⊗	⊗														
• INSERTS FAILURE MODES • MODOS DE RUPTURA DA PASTILHA • MODOS DE RUPTURA DE INSERTO	• catastrophic breakage • fractura catastrófica • rotura de inserto	⊗	⊗	⊗	⊗	⊗	⊗	⊗	⊗	⊗	⊗	⊗	⊗	⊗	⊗	⊗	⊗			⊗			⊗	P	P	

↑ ↓ Arrows indicate direction of adjustment | As setas indicam a direcção do ajustamento | Las flechas indican la dirección de ajuste
P Indicate areas of primary investigation | Indica as áreas de primeira intervenção | Indica las áreas de intervención primaria

CODIFICATION SYSTEM FOR SOLID CARBIDE END MILLS

Sistema de codificação para fresas de metal duro para acabamento | Sistema de codificación para fresas de carburo para acabado

Straight Flute example:

D	S	N	S	2	050	080	010	060
1	2	3	4	5	6	7	8	9

1 - Tool type

D - Diamond (PCD tipped)

2 - Design

B - Ball nose
S - Straight

4 - Application

N - Non-ferrous materials

5 - Length of Shank

S - Short length
L - Long length
XL - Extra long length

6 - Flutes number (Z)

Example: Z = 1 ; Z = 2 ; Z = 3

7 - Cutting diameter ($\varnothing D_c$)

Example: 120 = 12,0 mm ; 008 = 0,8 mm

8 - Max cutting depth (L2 - on straight flute solid carbide)

060 = 6 mm ; 080 = 8 mm

9 - Corner radius (Suppressed when it doesn't exist)

R... Example: R150 = 1,5 mm ; R015 = 0,15 mm

10 - Shank diameter (only on straight flute solid carbide)

Example: 060 = 6 mm

Straight Flute
technical drawing example

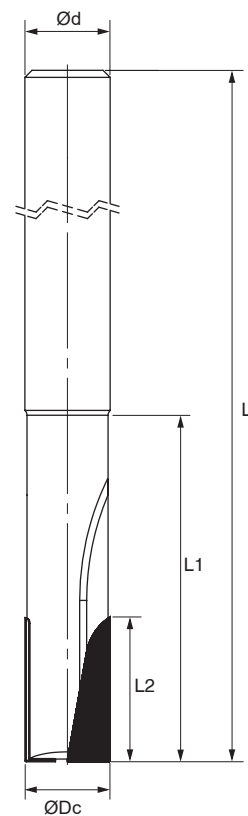

$\varnothing D_c$	Tool diameter
$\varnothing d$	Shank diameter
L	Overall length
L2	Tip length
r	Corner form (radius or chamfer)

PCD TIPPED END MILLS

Fresas de metal duro com pontas de PCD | Fresas de carburo com puntas de PCD



A

MILLING

Overview

Face milling

Hi-feed milling

Shoulder milling

Profile milling

Hardmill

Center & Chamfer

Spot face

Spare Parts

Technical Data

End Mills

HARDMILL BALL NOSE

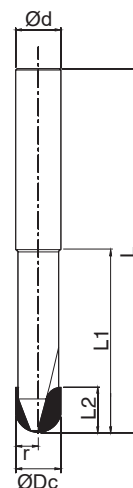

(1) Geometry code	(2) Grade code	Reference Referência Referencia	N PCD D6	Dimensions Dimensões Dimensiones (mm)					
				ØDc	Ød	L	L1	L2	r
1180079	DBNS 1 030 050 150 060	1	⊗	3	3	60	30	5	1,50
1180080	DBNS 1 040 100 200 040	1	⊗	4	4	60	30	10	2,00
1180081	DBNS 2 060 100 300 060	2	⊗	6	6	80	40	10	3,00
1180082	DBNS 2 080 100 400 080	2	⊗	8	8	80	40	10	4,00
1180083	DBNS 2 100 100 500 100	2	⊗	10	10	80	40	10	5,00
1180084	DBNS 2 120 100 600 120	2	○	12	12	100	60	10	6,00

⊗ Stock item | Produto de stock | Itens de stock

○ Available under request | Disponível sobre consulta | Disponible bajo consulta

Order code = (1) Geometry Code + (2) Grade Code

Material Group	Correction factor	V _c (m/min)
Aluminium cast alloys 5% < Si ≤ 12%	1,6	790-1000
Aluminium cast alloys 12% < Si	1,5	790-1000
Fibre-reinforced synthetics	1,0	400-500
Graphite	1,0	700-850

ØD				
	f _z (mm/t)	f _z (mm/t)	f _z (mm/t)	f _z (mm/t)
3	0,020	0,022		
4	0,025	0,028		
6	0,035	0,040		
8	0,050	0,055		
10	0,060	0,070		
12	0,075	0,078		

Please note that the value fz from the table above must be multiplied with the corresponding correction factor.

HARDMILL BULL NOSE

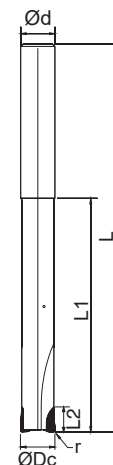

(1) Geometry code	(2) Grade code	Reference Referência Referencia	N PCD D6	Dimensions Dimensões Dimensiones (mm)					
				ØDc	Ød	L	L1	L2	r
1180073	DSNS 1 030 050 030 040	1	⊗	3	4	60	30	5	0,30
1180075	DSNL 2 040 050 030 040	2	⊗	4	4	75	45	5	0,30
1180076	DSNL 2 060 060 030 060	2	⊗	6	6	100	60	6	0,30
1180077	DSNL 2 080 060 030 080	2	⊗	8	8	125	80	6	0,30
1180074	DSNL 2 100 060 050 100	2	⊗	10	10	150	100	6	0,30
1180078	DSNL 2 120 070 050 120	2	⊗	12	12	150	100	7	0,30

⊗ Stock item | Produto de stock | Itens de stock

○ Available under request | Disponível sobre consulta | Disponible bajo consulta

Order code = (1) Geometry Code + (2) Grade Code

Material Group	Correction factor	V _c (m/min)
Aluminium cast alloys 5% < Si ≤ 12%	1,6	790-1000
Aluminium cast alloys 12% < Si	1,5	790-1000
Fibre-reinforced synthetics	1,0	400-500
Graphite	1,0	700-850

ØD	 $a_e = 0.2 \times \text{ØDc}$ $a_p = 0.1 \times \text{ØDc}$		 $a_p = 0.05 \times \text{ØDc}$	
	f _z (mm/t)	f _z (mm/t)	f _z (mm/t)	f _z (mm/t)
3	0,020		0,022	
4	0,025		0,028	
6	0,035		0,040	
8	0,050		0,055	
10	0,060		0,070	
12	0,075		0,078	

Please note that the value fz from the table above must be multiplied with the corresponding correction factor.

HARDMILL STRAIGHT EDGE

NEW

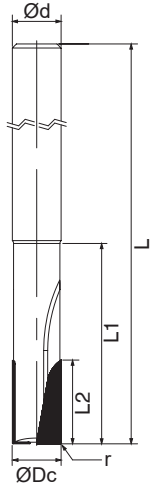

(1) Geometry code	Reference Referência Referencia	PCD	N D6 PDP410	Dimensions Dimensões Dimensiones (mm)					
				ØDc	Ød	L	L1	L2	r
1180011	DSNS 2 040 060 010 060	2	⊗	4	6	51	6,40	6	0,10
1180012	DSNS 2 050 080 010 060	2	⊗	5	6	51	8,40	8	0,10
1180006	DSNS 2 060 080 010 060	2	⊗	6	6	63	21	8	0,10
1180013	DSNS 2 080 080 010 080	2	⊗	8	8	63	27	8	0,10
1180014	DSNS 2 080 120 010 080	2	⊗	8	8	63	27	12	0,10
1180015	DSNS 2 100 080 010 100	2	⊗	10	10	72	32	8	0,10
1180016	DSNS 2 100 160 010 100	2	⊗	10	10	72	32	16	0,10
1180017	DSNS 2 120 080 010 120	2	⊗	12	12	83	38	8	0,10
1180018	DSNS 2 120 160 010 120	2	⊗	12	12	83	38	16	0,10
1180019	DSNS 3 140 080 010 140	3	⊗	14	14	83	38	8	0,10
1180020	DSNS 3 140 160 010 140	3	⊗	14	14	83	38	16	0,10
1180021	DSNS 3 160 120 010 160	3	⊗	16	16	100	52	12	0,10
1180022	DSNS 3 160 200 010 160	3	⊗	16	16	100	52	20	0,10

⊗ Stock item | Produto de stock | Itens de stock ○ Available under request | Disponível sobre consulta | Disponible bajo consulta order code = (1) Geometry Code + (2) Grade Code

NON-FERROUS MATERIALS | Materiais não ferrosos | Materiales no ferrosos

ISO	Workpiece Material	Vc (m/min)		fz (mm/t)		Coolant
		min	max	min	max	
N	Aluminium <6%Si	200	6000	0,05	0,30	Emulsion / MQL
	Aluminium <12%Si	200	4000	0,05	0,25	
	Aluminium >12%Si	200	2000	0,05	0,20	
	Cooper/Cooper Alloys	250	3000	0,03	0,30	

SYNTHETICS MATERIALS | Materiais sintéticos | Materiales sintéticos

ISO	Workpiece Material	Vc (m/min)		fz (mm/t)		Coolant
		min	max	min	max	
N	Graphit	150	2500	0,05	0,40	Dry/ Air
	GFRP, CFRP	200	3000	0,05	0,40	Dry/ Air
	Plastics (Termo/Duroplast)	100	2500	0,05	0,30	Emulsion/MQL
	Acrylic (PMMA)	100	1200	0,01	0,25	Emulsion /MQL
	Laminate	100	1200	0,02	0,50	Dry/Air

These recommended parameters are only approximate values. It can be necessary to adjust them regarding to the specific machining operation.

ANYTIME, ANYWHERE

Online ordering available 24-hour per day and shipments around the globe.



WWW.CLIENTS.PALBIT.PT

CODIFICATION SYSTEM FOR SOLID CARBIDE END MILLS

Sistema de codificação para fresas de metal duro para acabamento | Sistema de codificación para fresas de carburo para acabado

Straight Flute example:

H	F	30	G	S	4	120	32	R050	-	W
1	2	3	4	5	6	7	8	9		10

Integral Solid Carbide example:

1	2	3	4	5	6	7	8	9		10
----------	----------	----------	----------	----------	----------	----------	----------	----------	--	-----------

Overview

1 - Tool type

H - Solid carbide end mill (Hard metal)

Face milling

2 - Design

F - Square form (Flat top)
 R - Square form with corner radius
 C - Square form with corner chamfer
 B - Ball nose
 CH - Conical Top
 XC - Conical Segment
 XT - Tangential Segment
 RO - Rougher

Hifeed milling

Shoulder milling

3 - Helix Angle (Suppressed when it is 90°)

... - Degree of helix rounded to nearest 5 degree

Profile milling

4 - Application

A - Aluminium
 G - General application
 F - Finishing
 M - Steel
 S - Stainless steel
 H - Hard materials
 TSP - Trochoidal milling
 MIN - Micro milling

Hardmill

5 - Length of Shank

S - Short length
 L - Long length
 XL - Extra long length

Center & Chamfer

6 - Flutes number (Z)

Example: Z = 1 ; Z = 2 ; Z = 3 ;

Spot face

7 - Cutting diameter (ØDc)

Example: 120 = 12,0 mm ; 008 = 0,8 mm

Spare Parts

8 - Max cutting depth (ap)

Example: 04 = 4 mm ; 06 = 6 mm

Technical Data

9 - Shank diameter (only on straight flute solid carbide)

Example for corner radius: R150 = 1,5 mm ; R015 = 0,15 mm
 Example for conical segment: 18RM120 - $\alpha/2 = 18^\circ$, RM = 1200 mm
 Example for tangential segment: RM090 - RM = 90 mm

End Mills

10 - Weldon (Suppressed when it doesn't exist)

Integral Solid Carbide technical drawing example

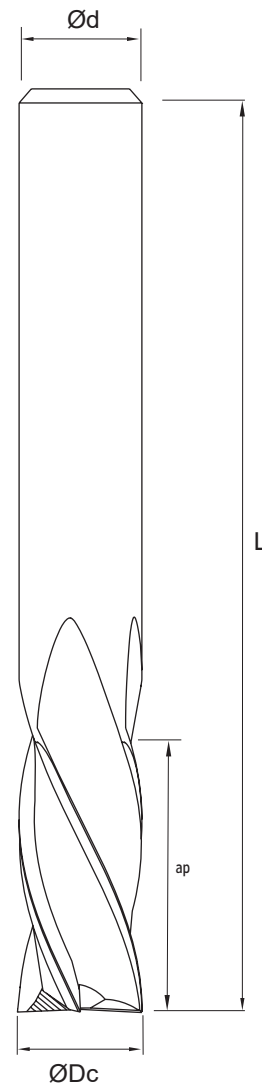

SOLID CARBIDE END MILLS

Fresas de metal duro inteeral | Fresas de carburo monobloque



A

MILLING

Overview

Face milling

Hi-feed milling

Shoulder milling

Profile milling

Hardmill

Center & Chamfer

Spot face

Spare Parts

Technical Data

End Mills

SELECTION GUIDE FOR SOLID CARBIDE ENDMILLS

A

MILLING

Overview

Face milling

Hi-feed milling

Shoulder milling

Profile milling

Hardmill

Center & Chamfer

Spotface

Spare Parts

Technical Data

End Mills

INTEG

General Purpose Endmills



HF30GS 2

HF30GS 4

HF30GXL 4

HR30GS 4

HB30GS 2

HB30GL 2

ØDc

2 - 20

2 - 20

2 - 12

3 - 20

2 - 12

4 - 12



2

4

4

4

2

2

Helix angle

30

30

30

30

30

30

Geometry



Square



Square



Square



Corner radius



Ball nose



Ball nose

Grade

PHP920

PHP920

PHP920

PHP920

PHP920

PHP920

Finishing



Roughing



P



K



M



N

S

H

Page

A - 268











































A - 269

A - 270

A - 271

A - 272

A - 272

INTEG			FIN-INTEG	MIN-INTEG	CHAMF INTEG
General Purpose Endmills			Finishing Endmills	Endmills for Micro Machining	Endmills for Chamferings
					
HB30GS 4	HB30GL 4	HRO45GS	HC45FL	HB30MINS	HCHGS
2 - 12	2 - 20	3 - 20	6 - 12	0,2 - 3,0	3 - 20
4	4	3 - 6	6	2	4
30	30	45	43 - 45	30	-
					
Ball nose	Ball nose	Rougher	Corner Chamfer	Ball nose	Conical Top
PHP920	PHP920	PHU920	PHU920	PHH603	PHU920
					
					
					
					
					
					
					
A - 273	A - 273	A - 275	A - 276	A - 278	A - 281

A

MILLING

Overview

Face milling

Hi-feed milling

Shoulder milling

Profile milling

Hardmill

Center & Chamfer

Spot face

Spare Parts

Technical Data

End Mills

SELECTION GUIDE FOR SOLID CARBIDE ENDMILLS

A

MILLING

Overview

Face milling

Hi-feed milling

Shoulder milling

Profile milling

Hardmill

Center & Chamfer

Spotface

Spare Parts

Technical Data

End Mills

	RAD-INTEG		DYN-INTEG	STEEL-INTEG	
	Radial Segment Endmills		Trochoidal Milling	Steel Specialized Endmills	
					
	HXC30GL	HXT30GL	HC40TSPL	HC35ML	HR35GL
ØDc	8 - 16	6 - 16	6 - 20	1 - 20	12 - 20
	4	4	5	4	4
Helix angle	30	30	40 - 42	35 - 38	35 - 38
Geometry	 Radial Segment	 Radial Segment	 Corner Chamfer	 Corner Chamfer	 Corner radius
Grade	PHP920 - PHH920	PHP920 - PHH920	PHP920	PHP920	PHP920
Finishing					
Roughing					
P					
K					
M					
N					
S					
H					
Page	A - 282	A - 282	A - 284	A - 285	A - 286

INOX-INTEG		AL-INTEG		HARD-INTEG	
Stainless Steel Specialized Endmills		Aluminium Specialized Endmills		We Make It Hard	
					
HC40SS	HRO40SS	HC38AS	HF30AS	HF30HL	HB30HL
1 - 20	3 - 20	3 - 20	2 - 12	4 - 12	2 - 12
4	4	3	1	4	2
39 - 41	39 - 41	38	30	30	30
					
Corner Chamfer	Rougher	Corner Chamfer	Square	Square	Ball nose
PHU920	PHU920	PH0920	PH0920	PHH603	PHH603
					
					
					
					
					
					
A - 287	A - 288	A - 289	A - 290	A - 291	A - 292

A

MILLING

Overview

Face milling

HiFeed milling

Shoulder milling

Profile milling

Hardmill

Center & Chamfer

Spot face

Spare Parts

Technical Data

End Mills

HF30GS 2 Flat top endmill

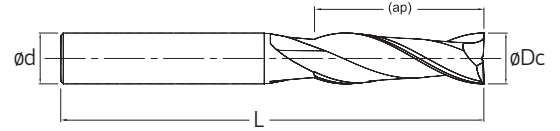

⁽¹⁾ Order code		Reference Referência Referencia		PHP920	Dimensions Dimensões Dimensiones (mm)			
HA (Cylindrical)	HB (Weldon)				ØDc	Ød (h6)	ap _{max}	L
1180587T1	-	HF30GS 2 020 06	<input checked="" type="checkbox"/>	2	2	4	6	38
1180588T1	-	HF30GS 2 030 12	<input checked="" type="checkbox"/>	2	3	4	12	38
1180589T1	-	HF30GS 2 040 14	<input checked="" type="checkbox"/>	2	4	4	14	50
1180590T1	-	HF30GS 2 050 16	<input checked="" type="checkbox"/>	2	5	6	16	50
1180591T1	-	HF30GS 2 060 19	<input checked="" type="checkbox"/>	2	6	6	19	50
1180592T1	1180532T1	HF30GS 2 080 20	<input checked="" type="checkbox"/>	2	8	8	20	63
1180593T1	1180533T1	HF30GS 2 100 22	<input checked="" type="checkbox"/>	2	10	10	22	75
1180594T1	1180534T1	HF30GS 2 120 25	<input checked="" type="checkbox"/>	2	12	12	25	75
1180595T1	1180535T1	HF30GS 2 140 26	<input checked="" type="checkbox"/>	2	14	14	26	83
1180596T1	1180536T1	HF30GS 2 160 32	<input checked="" type="checkbox"/>	2	16	16	32	89
1180597T1	1180537T1	HF30GS 2 180 32	<input checked="" type="checkbox"/>	2	18	18	32	92
1180598T1	1180538T1	HF30GS 2 200 38	<input checked="" type="checkbox"/>	2	20	20	38	104

Stock item | Produto de stock | Itens de stock

Available under request | Disponível sobre consulta
Disponível bajo consulta

HF30GS 4 Flat top endmill

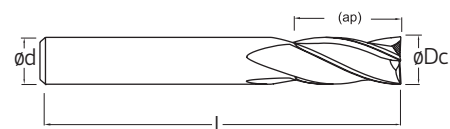

⁽¹⁾ Order code		Reference Referência Referencia		PHP920	Dimensions Dimensões Dimensiones (mm)			
HA (Cylindrical)	HB (Weldon)				ØDc	Ød (h6)	ap _{max}	L
1180262T1	-	HF30GS 4 020 06	4		2	4	6	38
1180219T1	-	HF30GS 4 030 12	4		3	4	12	38
1180215T1	-	HF30GS 4 040 14	4		4	4	14	50
1180195T1	-	HF30GS 4 050 16	4		5	6	16	50
1180263T1	-	HF30GS 4 060 19	4		6	6	19	50
1180223T1	1180605T1	HF30GS 4 070 19	4		7	8	19	63
1180202T1	1180544T1	HF30GS 4 080 20	4		8	8	20	63
1180224T1	1180606T1	HF30GS 4 090 22	4		9	10	22	75
1180216T1	1180545T1	HF30GS 4 100 22	4		10	10	22	75
1180264T1	1180546T1	HF30GS 4 120 25	4		12	12	25	75
1180220T1	1180547T1	HF30GS 4 140 26	4		14	14	26	83
1180129T1	1180548T1	HF30GS 4 160 32	4		16	16	32	89
1180221T1	1180549T1	HF30GS 4 180 32	4		18	18	32	92
1180222T1	1180550T1	HF30GS 4 200 38	4		20	20	38	104

Stock item | Produto de stock | Itens de stock

Available under request | Disponível sobre consulta
Disponível bajo consulta

HF30GXL 4 Flat top endmill



P M K

All order codes are cylindrical shank.
Weldon shank available under request.



(1) Geometry code	(2) Grade code Reference Referência Referencia	4	T1	G4	\Dimensions Dimensões Dimensiones (mm)			
			PHP920	PH7920	ØDc	Ød (h6)	ap _{max}	L
1180708	HF30GXL 4 020 09	4	○	△	2	4	9	100
1180265	HF30GXL 4 030 12	4	○	△	3	6	12	100
1180266	HF30GXL 4 040 16	4	○	△	4	6	16	100
1180267	HF30GXL 4 050 20	4	⊗		5	6	20	100
1180268	HF30GXL 4 060 20	4	○	△	6	6	20	100
1180269	HF30GXL 4 080 20	4	⊗		8	8	20	120
1180270	HF30GXL 4 100 25	4	○	△	10	10	25	120
1180057	HF30GXL 4 120 30	4	⊗		12	12	30	120

⊗ Stock item | Produto de stock
Itens de stock

△ Stock available until sold out | Stock disponível até acabar o stock
Stock disponible hasta acabar el stock

○ Available under request | Disponível sobre consulta
Disponível bajo consulta

Endmill order code = (1) Geometry Code + (2) Grade Code

- A
- MILLING
- Overview
- Face milling
- Hifeed milling
- Shoulder milling
- Profile milling
- Hardmill
- Center & Chamfer
- Spot face
- Spare Parts
- Technical Data
- End Mills

HR30GS 4 Round corner endmill

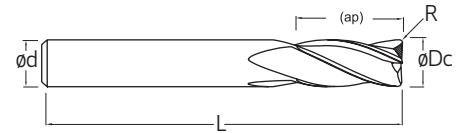
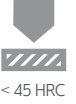

All order codes are cylindrical shank.
Weldon shank available under request.

(1) Order code	Reference Referência Referencia		PHP920	Dimensions Dimensões Dimensiones (mm)				
				ϕDc	$\phi d (h6)$	ap_{max}	R	L
1180231T1	HR30GS 4 030 12 R025	4	○	3	4	12	0,25	50
1180232T1	HR30GS 4 030 12 R050	4	○	3	4	12	0,5	50
1180233T1	HR30GS 4 040 14 R025	4	○	4	4	14	0,25	50
1180234T1	HR30GS 4 040 14 R050	4	○	4	4	14	0,5	50
1180235T1	HR30GS 4 050 16 R025	4	○	5	6	16	0,25	50
1180236T1	HR30GS 4 050 16 R050	4	○	5	6	16	0,5	50
1180237T1	HR30GS 4 060 19 R050	4	⊗	6	6	19	0,5	50
1180238T1	HR30GS 4 060 19 R100	4	⊗	6	6	19	1	50
1180239T1	HR30GS 4 070 19 R050	4	○	7	8	19	0,5	63
1180240T1	HR30GS 4 070 19 R100	4	○	7	8	19	1	63
1180241T1	HR30GS 4 080 20 R050	4	⊗	8	8	20	0,5	63
1180242T1	HR30GS 4 080 20 R100	4	⊗	8	8	20	1	63
1180243T1	HR30GS 4 090 22 R050	4	○	9	10	22	0,5	75
1180244T1	HR30GS 4 090 22 R100	4	○	9	10	22	1	75
1180245T1	HR30GS 4 100 22 R100	4	⊗	10	10	22	1	75
1180246T1	HR30GS 4 100 22 R200	4	⊗	10	10	22	2	75
1180247T1	HR30GS 4 120 25 R100	4	⊗	12	12	25	1	75
1180248T1	HR30GS 4 120 25 R200	4	⊗	12	12	25	2	75
1180249T1	HR30GS 4 140 26 R100	4	○	14	14	26	1	83
1180250T1	HR30GS 4 140 26 R200	4	○	14	14	26	2	83
1180251T1	HR30GS 4 160 32 R100	4	⊗	16	16	32	1	89
1180252T1	HR30GS 4 160 32 R200	4	⊗	16	16	32	2	89
1180253T1	HR30GS 4 180 32 R100	4	○	18	18	32	1	92
1180254T1	HR30GS 4 180 32 R200	4	○	18	18	32	2	92
1180255T1	HR30GS 4 200 38 R100	4	⊗	20	20	38	1	104
1180256T1	HR30GS 4 200 38 R200	4	⊗	20	20	38	2	104

⊗ Stock item | Produto de stock | Itens de stock

○ Available under request | Disponível sobre consulta
Disponível bajo consulta

HB30GS 2 Ball nose endmill

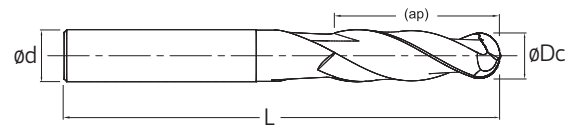

All order codes are cylindrical shank.
Weldon shank available under request.

(1) Geometry code	(2) Grade code Reference Referência Referencia	⊕	T1 PHP920	G4 PH7920	Dimensions Dimensões Dimensiones (mm)			
					ØDc	Ød (h6)	ap _{max}	L
1180278	HB30GS 2 020 06	2	⊕	⊕	2	3	6	38
1180279	HB30GS 2 030 12	2	○	⊕	3	3	12	38
1180280	HB30GS 2 040 14	2	○	⊕	4	4	14	50
1180281	HB30GS 2 050 16	2	⊕		5	6	16	50
1180282	HB30GS 2 060 19	2	○	⊕	6	6	19	50
1180283	HB30GS 2 080 20	2	⊕		8	8	20	63
1180284	HB30GS 2 100 22	2	⊕		10	10	22	75
1180285	HB30GS 2 120 25	2	⊕		12	12	25	75

⊕ Stock item | Produto de stock | Itens de stock
 ⊕ Stock available until sold out | Stock disponível até acabar o stock | Stock disponible hasta acabar el stock
 ○ Available under request | Disponível sobre consulta | Disponible bajo consulta
 Endmill order code = (1) Geometry Code + (2) Grade Code

HB30GL 2 Ball nose endmill

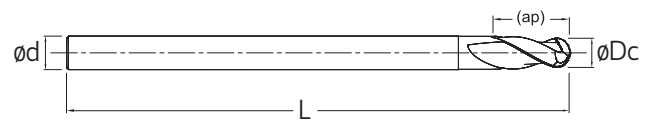

All order codes are cylindrical shank.
Weldon shank available under request.

(1) Order code	Reference Referência Referencia	⊕	PHP920	Dimensions Dimensões Dimensiones (mm)			
				ØDc	Ød (h6)	ap _{max}	L
1180286T1	HB30GL 2 040 08	2	⊕	4	6	8	75
1180128T1	HB30GL 2 060 12	2	⊕	6	6	12	75
1180029T1	HB30GL 2 080 14	2	⊕	8	8	14	100
1180030T1	HB30GL 2 100 18	2	⊕	10	10	18	100
1180031T1	HB30GL 2 120 22	2	⊕	12	12	22	120

⊕ Stock item | Produto de stock | Itens de stock
 ⊕ Stock available until sold out | Stock disponível até acabar o stock | Stock disponible hasta acabar el stock
 ○ Available under request | Disponível sobre consulta | Disponible bajo consulta

HB30GS 4 Ball nose endmill

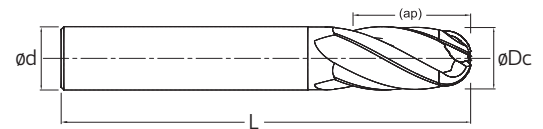

All order codes are cylindrical shank.
Weldon shank available under request.

(1) Order code	Reference Referência Referencia		PHP920	Dimensions Dimensões Dimensiones (mm)			
				ØDc	Ød (h6)	ap _{max}	L
1180156T1	HB30GS 4 020 03	4		2	4	3	50
1180157T1	HB30GS 4 030 05	4		3	4	5	50
1180068T1	HB30GS 4 040 06	4		4	6	6	60
1180272T1	HB30GS 4 060 09	4		6	6	9	60
1180066T1	HB30GS 4 080 16	4		8	8	16	63
1180432T1	HB30GS 4 100 20	4		10	10	20	75
1180287T1	HB30GS 4 120 25	4		12	12	25	75

Stock item | Produto de stock
Itens de stock

Stock available until sold out | Stock disponível até acabar o stock
Stock disponible hasta acabar el stock

Available under request | Disponível sobre consulta
Disponível bajo consulta

HB30GL 4 Ball nose endmill

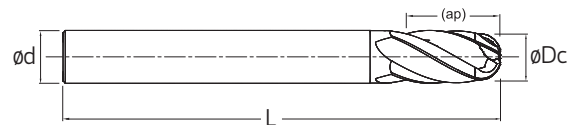

All order codes are cylindrical shank.
Weldon shank available under request.

(1) Order code	Reference Referência Referencia		PHP920	Dimensions Dimensões Dimensiones (mm)			
				ØDc	Ød (h6)	ap _{max}	L
1180273T1	HB30GL 4 020 04	4		2	4	4	75
1180274T1	HB30GL 4 030 08	4		3	4	8	75
1180275T1	HB30GL 4 040 11	4		4	4	11	75
1180150T1	HB30GL 4 050 13	4		5	6	13	75
1180032T1	HB30GL 4 060 13	4		6	6	13	75
1180064T1	HB30GL 4 080 16	4		8	8	16	100
1180065T1	HB30GL 4 100 16	4		10	10	16	100
1180071T1	HB30GL 4 120 25	4		12	12	25	100
1180276T1	HB30GL 4 160 32	4		16	16	32	120
1180277T1	HB30GL 4 200 38	4		20	20	38	120

Stock item | Produto de stock
Itens de stock

Stock available until sold out | Stock disponível até acabar o stock
Stock disponible hasta acabar el stock

Available under request | Disponível sobre consulta
Disponível bajo consulta

CUTTING PARAMETERS || Parâmetros de corte | Parámetros de corte

Side Milling

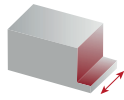

Finishing: $a_e < 0,15 \times D_c$
 Semi-finishing: $0,15 \times D_c < a_e < 0,3 \times D_c$
 Roughing: $a_e > 0,3 \times D_c$

Slotting

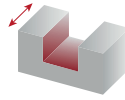

$a_e = 100\% \times D_c$

Copying

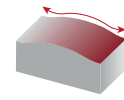

Finishing: $a_e < 0,20 \times D_c$
 $a_p < 0,03 \times D_c$
 Semi-finishing: $0,20 \times D_c < a_e < 0,40 \times D_c$
 $0,03 \times D_c < a_p < 0,10 \times D_c$
 Roughing: $a_e > 0,40 \times D_c$
 $a_p > 0,10 \times D_c$

α : Surface inclination angle.

ISO	Material	fz (mm/t)					
		Side Milling			Slotting	Copying	
		$a_e = 12,5\%$	$a_e = 25\%$	$a_e = 50\%$	$a_e = 100\%$	$\alpha < 15^\circ$	$\alpha > 15^\circ$
P	Unalloyed Steel	$0,009 \times D_c$	$0,008 \times D_c$	$0,005 \times D_c$	$0,004 \times D_c$	$0,012 \times D_c$	$0,004 \times D_c$
	Low-Alloyed Steel	$0,008 \times D_c$	$0,007 \times D_c$	$0,004 \times D_c$	$0,003 \times D_c$	$0,010 \times D_c$	$0,003 \times D_c$
	High-Alloyed Steel	$0,007 \times D_c$	$0,006 \times D_c$	$0,004 \times D_c$	$0,003 \times D_c$	$0,009 \times D_c$	$0,003 \times D_c$
M	Stainless Steel (Ferritic / Martensitic)	$0,007 \times D_c$	$0,006 \times D_c$	$0,004 \times D_c$	$0,003 \times D_c$	$0,009 \times D_c$	$0,003 \times D_c$
	Stainless Steel (Austenitic)	$0,005 \times D_c$	$0,005 \times D_c$	$0,003 \times D_c$	$0,002 \times D_c$	$0,007 \times D_c$	$0,002 \times D_c$
	Stainless Steel (Austenitic/Ferritic/Duplex)	$0,004 \times D_c$	$0,004 \times D_c$	$0,002 \times D_c$	$0,002 \times D_c$	$0,006 \times D_c$	$0,002 \times D_c$
K	Malleable Cast Iron	$0,009 \times D_c$	$0,008 \times D_c$	$0,005 \times D_c$	$0,004 \times D_c$	$0,012 \times D_c$	$0,004 \times D_c$
	Grey Cast Iron	$0,009 \times D_c$	$0,008 \times D_c$	$0,005 \times D_c$	$0,004 \times D_c$	$0,012 \times D_c$	$0,004 \times D_c$
	Nodular Cast Iron	$0,008 \times D_c$	$0,008 \times D_c$	$0,004 \times D_c$	$0,004 \times D_c$	$0,011 \times D_c$	$0,004 \times D_c$

(Note 1) Side milling and slotting feed valid for when the endmill works with its whole a_p , for when the endmill is working with lower depths of cut consider increasing the feed up to 25%.

(Note 2) Copying feed valid for low a_p ($a_p / D < 0,1$), for higher a_p consider decreasing the feed by 50%.

ISO	Material	Vc (m/min)							
		Side Milling			Slotting	Copying			
		$a_e = 12,5\%$	$a_e = 25\%$	$a_e = 50\%$	$a_e = 100\%$	$a_p = 0,05\phi D_c$ $\alpha < 15^\circ$	$a_p = 0,25\phi D$ $\alpha < 15^\circ$	$a_p = 0,05\phi D_c$ $\alpha > 15^\circ$	$a_p = 0,25\phi D_c$ $\alpha > 15^\circ$
P	Unalloyed Steel	200	190	180	150	480	240	320	160
	Low-Alloyed Steel	190	180	160	130	440	220	290	150
	High-Alloyed Steel	170	160	150	120	400	200	260	130
M	Stainless Steel (Ferritic / Martensitic)	150	140	130	110	360	180	240	120
	Stainless Steel (Austenitic)	120	110	100	80	290	140	190	100
	Stainless Steel (Austenitic/Ferritic/Duplex)	100	100	80	70	250	120	160	80
K	Malleable Cast Iron	240	230	220	170	580	290	380	190
	Grey Cast Iron	230	230	210	170	560	280	380	190
	Nodular Cast Iron	220	210	190	160	520	260	350	170

(Note 3) Table valid for PHP920 grade, for PH7920 consider reducing the cutting velocity by 10 m/min.

(Note 4) Cutting speeds selected for an economic use of the tool, for higher productivity consider increasing up to 70%.

(Note 5) For copying, spindle speed is calculated as follows: $n = \frac{V_c \times 1000}{\pi \times 2 \sqrt{a_p(D_c - a_p)}}$

HRO45GS Rougher endmill



P M K

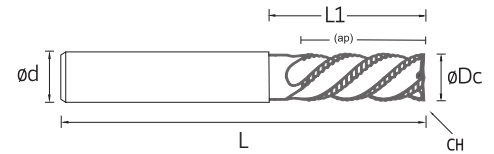

⁽¹⁾ Order code		Reference Referência Referencia		PHU920	Dimensions Dimensões Dimensiones (mm)					
HA (Cylindrical)	HB (Weldon)				ØDc	Ød	ap max	CH	L1	L
1180557Z9	1180558Z9	HRO45GS 3 030 08	3	○	3	6	8	0,15 x 45°	15	57
1180559Z9	1180560Z9	HRO45GS 4 040 11	4	○	4	6	11	0,15 x 45°	17	57
1180561Z9	1180562Z9	HRO45GS 4 050 13	4	○	5	6	13	0,15 x 45°	19	57
1180439Z9	1180563Z9	HRO45GS 4 060 13	4	⊗	6	6	13	0,15 x 45°	21	57
1180440Z9	1180564Z9	HRO45GS 4 080 19	4	⊗	8	8	19	0,15 x 45°	27	63
1180441Z9	1180565Z9	HRO45GS 4 100 22	4	⊗	10	10	22	0,20 x 45°	32	72
1180374Z9	1180465Z9	HRO45GS 4 120 26	4	⊗	12	12	26	0,20 x 45°	38	83
1180566Z9	1180567Z9	HRO45GS 5 160 32	5	⊗	16	16	32	0,35 x 45°	44	92
1180568Z9	1180569Z9	HRO45GS 6 200 38	6	⊗	20	20	38	0,60 x 45°	54	104

⊗ Stock item | Produto de stock | Itens de stock

○ Available under request | Disponível sobre consulta
Disponível bajo consulta

CUTTING CONDITIONS | Condições de corte | Condiciones de corte

ISO	Material	fz (mm/t)			Vc (m/min)		
		ae = 25%	ae = 50%	ae = 100%	ae = 25%	ae = 50%	ae = 100%
P	Unalloyed Steel	0,008 x ØDc	0,007 x ØDc	0,005 x ØDc	170	160	140
	Low-Alloyed Steel	0,007 x ØDc	0,006 x ØDc	0,004 x ØDc	150	140	120
	High-Alloyed Steel	0,006 x ØDc	0,005 x ØDc	0,004 x ØDc	130	120	100
M	Stainless Steel (Ferritic / Martensitic)	0,006 x ØDc	0,005 x ØDc	0,004 x ØDc	110	110	90
	Stainless Steel (Austenitic)	0,005 x ØDc	0,004 x ØDc	0,003 x ØDc	100	90	80
	Stainless Steel (Austenitic/Ferritic/Duplex)	0,004 x ØDc	0,003 x ØDc	0,002 x ØDc	80	80	70
K	Malleable Cast Iron	0,008 x ØDc	0,007 x ØDc	0,005 x ØDc	200	190	170
	Grey Cast Iron	0,008 x ØDc	0,007 x ØDc	0,005 x ØDc	200	190	160
	Nodular Cast Iron	0,008 x ØDc	0,007 x ØDc	0,004 x ØDc	180	170	150

HC45FL Corner chamfer finishing endmills

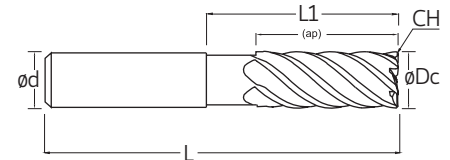

All order codes are cylindrical shank.
Weldon shank available under request.

(1) Geometry code	(2) Grade code		X7	T1	Dimensions Dimensões Dimensiones (mm)							
	Reference Referência Referencia	⊕			PHP603	PHP920	ØDc	Ød (h6)	ap _{max}	CH	L1	L
1180845	HC45FL 6 030 08	6	⊕	○	3	6	8	0,15 × 45°	15	57		
1180846	HC45FL 6 040 11	6	⊕	○	4	6	11	0,15 × 45°	17	57		
1180847	HC45FL 6 050 13	6	⊕	○	5	6	13	0,15 × 45°	19	57		
1180342	HC45FL 6 060 13	6	⊕	⊕	6	6	13	0,15 × 45°	21	57		
1180062	HC45FL 6 080 19	6	⊕	⊕	8	8	19	0,15 × 45°	28	63		
1180344	HC45FL 6 100 22	6	⊕	⊕	10	10	22	0,20 × 45°	30	72		
1180343	HC45FL 6 120 26	6	⊕	⊕	12	12	26	0,20 × 45°	34	83		
1180848	HC45FL 6 160 32	6	○	○	16	16	32	0,35 × 45°	44	92		
1180849	HC45FL 6 200 38	6	○	○	20	20	38	0,60 × 45°	54	104		

⊕ Stock item | Produto de stock | Itens de stock

○ Available under request | Disponível sobre consulta
Disponível bajo consulta

Endmill order code = (1) Geometry Code + (2) Grade Code

GRADES SELECTION GUIDE | Guia para seleção de graus | Tabla para selección de calidades

ISO	Material	Grades	
		PHP603	PHP920
P	Unalloyed Steel	☹	☹
	Low-Alloyed Steel	☹	☹
	High-Alloyed Steel	☹	☹
M	Stainless Steel (Ferritic / Martensitic)	☹	☹
	Stainless Steel (Austenitic)	☹	☹
	Stainless Steel (Austenitic/Ferritic/Duplex)	☹	☹
K	Malleable Cast Iron	☹	☹
	Grey Cast Iron	☹	☹
	Nodular Cast Iron	☹	☹
H	Hardened Steels	☹	—

☹ First choice | 1ª Escolha | 1ª Opción

☹ Suitable | Adequado | Adecuado

CUTTING PARAMETERS | Parâmetros de corte | Parámetros de corte

ISO	Material	Vc (m/min)		fz (mm/t)
		PHP603	PHP920	
P	Unalloyed Steel	200	190	0,009 x ØDc
	Low-Alloyed Steel	170	160	0,007 x ØDc
	High-Alloyed Steel	140	130	0,005 x ØDc
M	Stainless Steel (Ferritic / Martensitic)	130	120	0,006 x ØDc
	Stainless Steel (Austenitic)	120	110	0,005 x ØDc
	Stainless Steel (Austenitic/Ferritic/Duplex)	90	90	0,004 x ØDc
K	Malleable Cast Iron	240	230	0,009 x ØDc
	Grey Cast Iron	240	230	0,009 x ØDc
	Nodular Cast Iron	200	190	0,008 x ØDc
H	Hardened Steels	80	—	0,004 x ØDc

Note¹: Feed valid for when the endmill works with its whole ap, for when the endmill is working with lower depths of cut consider increasing the feed up to 25%.

Note²: Cutting speeds selected for an economic use of the tool, for higher productivity consider increasing up to 70%.

HB30MINS Short neck endmills for micro machining



Short



2



30°



Reduced Neck Ø



Ball nose



< 70 HRC

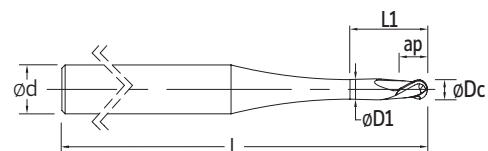

All order codes are cylindrical shank.
Weldon shank available under request.

(1) Order code	Reference Referência Referencia	⊕	PHH603	Dimensions Dimensões Dimensiones (mm)					
				ØDc	Ød (h6)	D1	ap	L1	L
1180297X4	HB30MINS 2 005 01 015	2	⊕	0,5	4	0,45	0,6	1,5	50
1180288X4	HB30MINS 2 006 01 020	2	⊕	0,6	4	0,58	0,6	2	50
1180289X4	HB30MINS 2 008 01 020	2	⊕	0,8	4	0,78	0,8	2	50
1180298X4	HB30MINS 2 010 02 025	2	⊕	1	4	0,95	1,3	2,5	50
1180290X4	HB30MINS 2 010 01 030	2	⊕	1	4	0,95	1	3	50
1180291X4	HB30MINS 2 012 02 030	2	⊕	1,2	4	1,15	1,2	3	50
1180292X4	HB30MINS 2 016 02 040	2	⊕	1,6	4	1,55	1,6	4	50
1180293X4	HB30MINS 2 020 02 040	2	⊕	2	4	1,94	2	4	50
1180307X4	HB30MINS 2 020 03 050	2	⊕	2	4	1,95	2,5	5	50
1180299X4	HB30MINS 2 025 03 060	2	⊕	2,5	6	2,45	3	6	60
1180309X4	HB30MINS 2 030 04 075	2	⊕	3	6	2,95	4	7,5	60

⊕ Stock item | Produto de stock | Itens de stock

○ Available under request | Disponível sobre consulta
Disponível bajo consulta

HB30MINS Medium neck endmills for micro machining



Short



2



30°



Reduced Neck Ø



Ball nose



< 70 HRC

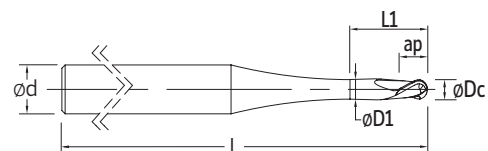

All order codes are cylindrical shank.
Weldon shank available under request.

(1) Order code	Reference Referência Referencia		PHH603	Dimensions Dimensões Dimensiones (mm)					
				ØDc	Ød (h6)	D1	ap	L1	L
1180305X4	HB30MINS 2 005 01 025	2		0,5	4	0,45	0,4	2,5	50
1180308X4	HB30MINS 2 010 02 050	2		1	4	0,95	1,3	5	50
1180336X4	HB30MINS 2 016 02 080	2		1,6	4	1,55	1,6	8	50
1180310X4	HB30MINS 2 020 03 100	2		2	4	1,95	2,5	10	50
1180311X4	HB30MINS 2 025 03 125	2		2,5	6	2,45	3	12,5	60
1180301X4	HB30MINS 2 030 04 150	2		3	6	2,95	4	15	60

Stock item | Produto de stock | Itens de stock

Available under request | Disponível sobre consulta
Disponível bajo consulta

HB30MINS Long neck endmills for micro machining



Short



2



30°



Reduced Neck Ø



Ball nose



< 70 HRC

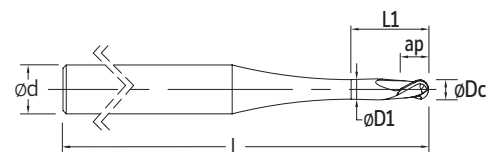

All order codes are cylindrical shank.
Weldon shank available under request.

(1) Order code	Reference Referência Referencia		PHH603	Dimensions Dimensões Dimensiones (mm)					
				ØDc	Ød (h6)	D1	ap	L1	L
1180306X4	HB30MINS 2 005 01 040	2		0,5	4	0,45	0,6	4	50
1180300X4	HB30MINS 2 010 02 080	2		1	4	0,95	1,3	8	50
1180337X4	HB30MINS 2 016 02 128	2		1,6	4	1,55	1,6	12,8	50
1180302X4	HB30MINS 2 020 03 160	2		2	4	1,95	2,5	16	50
1180312X4	HB30MINS 2 025 03 200	2		2,5	6	2,45	3	20	60
1180313X4	HB30MINS 2 030 04 240	2		3	6	2,95	4	24	60

Stock item | Produto de stock | Itens de stock

Available under request | Disponível sobre consulta
Disponível bajo consulta

CUTTING PARAMETERS || Parâmetros de corte | Parámetros de corte

ISO	Material	Copying					
		fz (mm/t)		Vc (m/min)			
		$\alpha < 15^\circ$	$\alpha > 15^\circ$	$a_p = 0,05 \text{ } \varnothing D_c$ $\alpha < 15^\circ$	$a_p = 0,25 \text{ } \varnothing D$ $\alpha < 15^\circ$	$a_p = 0,05 \text{ } \varnothing D_c$ $\alpha > 15^\circ$	$a_p = 0,25 \text{ } \varnothing D$ $\alpha > 15^\circ$
P	Unalloyed Steel	0,01 x $\varnothing D_c$	0,003 x $\varnothing D_c$	700	340	460	220
	Low-Alloyed Steel	0,009 x $\varnothing D_c$	0,003 x $\varnothing D_c$	650	320	430	210
	High-Alloyed Steel	0,008 x $\varnothing D_c$	0,003 x $\varnothing D_c$	590	290	390	190
M	Stainless Steel (Ferritic / Martensitic)	0,009 x $\varnothing D_c$	0,003 x $\varnothing D_c$	600	300	400	200
	Stainless Steel (Austenitic)	0,008 x $\varnothing D_c$	0,003 x $\varnothing D_c$	560	280	370	190
	Stainless Steel (Austenitic/Ferritic/Duplex)	0,007 x $\varnothing D_c$	0,002 x $\varnothing D_c$	540	270	360	180
K	Malleable Cast Iron	0,008 x $\varnothing D_c$	0,003 x $\varnothing D_c$	650	320	430	210
	Grey Cast Iron	0,008 x $\varnothing D_c$	0,003 x $\varnothing D_c$	640	310	420	200
	Nodular Cast Iron	0,007 x $\varnothing D_c$	0,002 x $\varnothing D_c$	600	300	400	190
S	Heat Resistant Super Alloys	0,007 x $\varnothing D_c$	0,002 x $\varnothing D_c$	230	110	150	80
H	Hardened Steels	0,008 x $\varnothing D_c$	0,003 x $\varnothing D_c$	460	230	310	150

Note: Since some of the endmills have low $\varnothing D_c$ the above Vc cannot be achieved by any conventional machining center. The endmills still work at much lower Vc.

A

MILLING

Overview

Face milling

Hi-feed milling

Shoulder milling

Profile milling

Hardmill

Center & Chamfer

Spot face

Spare Parts

Technical Data

End Mills

HCHGS Chamfering endmill



P M K

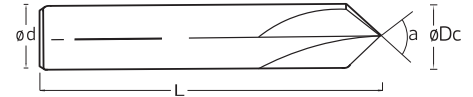
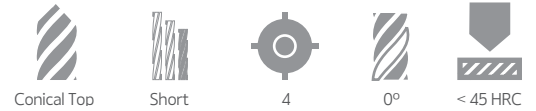

⁽¹⁾ Order code		Reference Referência Referencia		PHU920	Dimensions Dimensões Dimensiones (mm)			
HA (Cylindrical)	HB (Weldon)				ØDc	Ød (h6)	a	L
1180366Z9	-	HCHGS 4 030 02 90	4		3	3	90	38
1180367Z9	-	HCHGS 4 040 02 90	4		4	4	90	50
1180368Z9	1180496Z9	HCHGS 4 060 03 90	4		6	6	90	57
1180369Z9	1180497Z9	HCHGS 4 080 04 90	4		8	8	90	63
1180370Z9	1180498Z9	HCHGS 4 100 05 90	4		10	10	90	72
1180371Z9	1180499Z9	HCHGS 4 120 06 90	4		12	12	90	83
1180372Z9	1180500Z9	HCHGS 4 160 08 90	4		16	16	90	92
1180373Z9	1180553Z9	HCHGS 4 200 10 90	4		20	20	90	104

Stock item | Produto de stock | Itens de stock

Available under request | Disponível sobre consulta
Disponível bajo consulta

Endmill order code = (1) Geometry Code + (2) Grade Code

Note: For HB (weldon) endmills, the reference ends with "-W"

CUTTING PARAMETERS || Parâmetros de corte | Parámetros de corte

ISO	Material	Chamfering	
		fz (mm/t)	Vc (m/min)
P	Unalloyed Steel	0,008 x ØDc	180
	Low-Alloyed Steel	0,007 x ØDc	160
	High-Alloyed Steel	0,006 x ØDc	140
M	Stainless Steel (Ferritic / Martensitic)	0,007 x ØDc	150
	Stainless Steel (Austenitic)	0,006 x ØDc	130
	Stainless Steel (Austenitic/Ferritic/Duplex)	0,004 x ØDc	110
K	Malleable Cast Iron	0,008 x ØDc	210
	Grey Cast Iron	0,008 x ØDc	210
	Nodular Cast Iron	0,008 x ØDc	190

RAD-INTEG = Conical and Tangential Segment Endmills

NEW

A

HXC30GL = CONICAL

MILLING

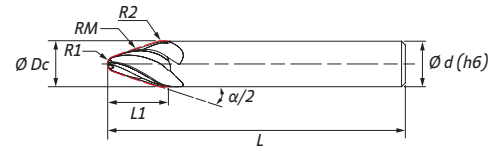

All order codes are cylindrical shank.
Weldon shank available under request.

Overview

Face milling

Hi-feed milling

Shoulder milling

(1) Geometry code	(2) Grade code Reference Referência Referencia	Flutes	T1		Y3		Dimensions Dimensões Dimensiones (mm)					
			PHP920	PHH920	$\varnothing D_c$	$\varnothing d (h6)$	$\alpha/2$	RM	R1	R2	L1	L
1180046	HXC30GL 4 080 10 18RM030	4	⊗	⊗	8	8	18	300	1	1	10	75
1180047	HXC30GL 4 120 14 18RM045	4	⊗	⊗	12	12	18	450	2	2	14	83
1180048	HXC30GL 4 160 18 18RM120	4	⊗	⊗	16	16	18	1200	3	3	18	95
1180049	HXC30GL 4 160 12 28RM080	4	⊗	⊗	16	16	28	800	3	3	12	95
1180050	HXC30GL 4 160 16 18RM120	4	⊗	⊗	16	16	18	1200	4	4	16	110
1180051	HXC30GL 4 160 11 28RM080	4	⊗	⊗	16	16	28	800	4	4	11	110

⊗ Stock item | Produto de stock | Itens de stock

○ Available under request | Disponível sobre consulta
Disponível bajo consulta

Endmill order code = (1) Geometry Code + (2) Grade Code

Profile milling

HXT30GL = TANGENTIAL

Hardmill

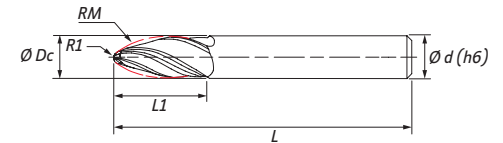

All order codes are cylindrical shank.
Weldon shank available under request.

Center & Chamfer

Spot face

(1) Geometry code	(2) Grade code Reference Referência Referencia	Flutes	T1		Y3		Dimensions Dimensões Dimensiones (mm)			
			PHP920	PHH920	$\varnothing D_c$	$\varnothing d (h6)$	RM	R1	L1	L
1180045	HXT30GL 3 060 22 RM095	4	⊗	⊗	6	6	95	1	22	63
1180037	HXT30GL 4 080 24 RM095	4	⊗	⊗	8	8	95	1	24	70
1180038	HXT30GL 4 100 28 RM085	4	⊗	⊗	10	10	85	2	28	72
1180039	HXT30GL 4 120 28 RM090	4	⊗	⊗	12	12	90	2	28	83
1180691	HXT30GL 4 160 30 RM080	4	⊗	⊗	16	16	80	3	30	110

⊗ Stock item | Produto de stock | Itens de stock

○ Available under request | Disponível sobre consulta
Disponível bajo consulta

Endmill order code = (1) Geometry Code + (2) Grade Code

Spare Parts

Technical Data

End Mills

GRADES SELECTION GUIDE | Guia para seleção de graus | Tabla para selección de calidades

ISO	Material	Grades	
		PHP920	PHH920
P	Unalloyed Steel	⊗	
	Low-Alloyed Steel	⊗	
	High-Alloyed Steel	⊗	
M	Stainless Steel (Ferritic / Martensitic)		⊗
	Stainless Steel (Austenitic)		⊗
	Stainless Steel (Austenitic/Ferritic/Duplex)		⊗
K	Malleable Cast Iron	⊗	
	Grey Cast Iron	⊗	
	Nodular Cast Iron	⊗	
S	Heat Resistant Super Alloys		⊗

RECOMMENDED CUTTING CONDITIONS | Condições de corte recomendadas | Condiciones de corte recomendables

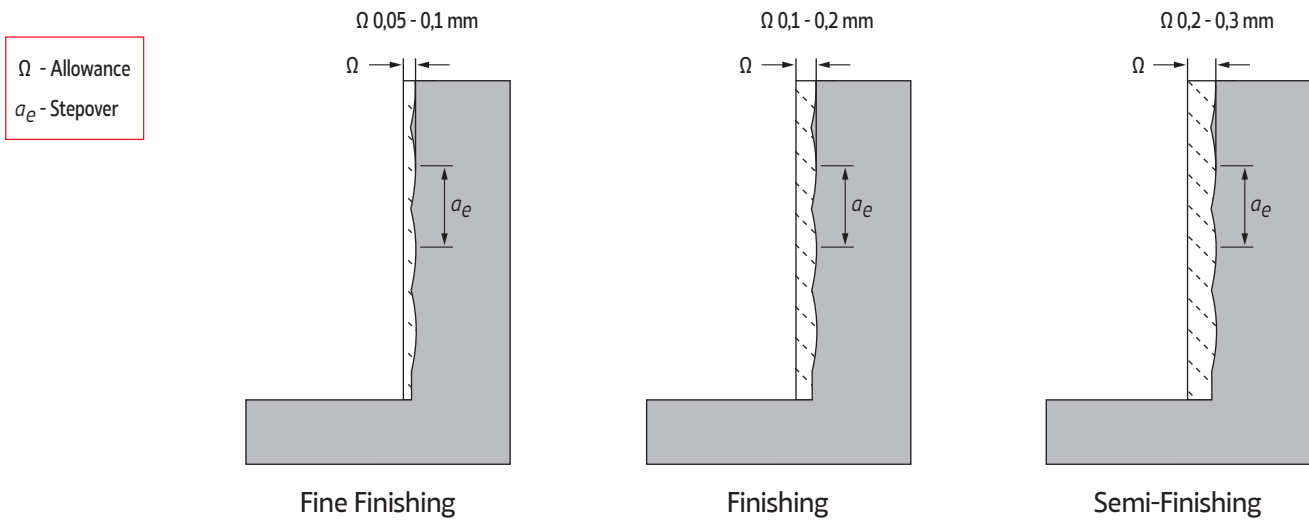

ISO	Workpiece Material	Vc (m/min)	fz (mm/t)				
			HXC30GL - Conical		HXT30GL - Tangential		
			Ω 0,05 - 0,1 mm	Ω 0,1 - 0,2 mm	Ω 0,05 - 0,1 mm	Ω 0,1 - 0,2 mm	Ω 0,2 - 0,3 mm
P	Unalloyed Steel	180	0,007 x \varnothing Dc	0,006 x \varnothing Dc	0,007 x \varnothing Dc	0,006 x \varnothing Dc	0,005 x \varnothing Dc
	Low-Alloyed Steel	160	0,006 x \varnothing Dc	0,005 x \varnothing Dc	0,006 x \varnothing Dc	0,005 x \varnothing Dc	0,004 x \varnothing Dc
	High-Alloyed Steel	150	0,005 x \varnothing Dc	0,004 x \varnothing Dc	0,005 x \varnothing Dc	0,004 x \varnothing Dc	0,004 x \varnothing Dc
M	Stainless Steel (Ferritic / Martensitic)	120	0,005 x \varnothing Dc	0,004 x \varnothing Dc	0,005 x \varnothing Dc	0,004 x \varnothing Dc	0,004 x \varnothing Dc
	Stainless Steel (Austenitic)	120	0,004 x \varnothing Dc	0,003 x \varnothing Dc	0,004 x \varnothing Dc	0,003 x \varnothing Dc	0,003 x \varnothing Dc
	Stainless Steel (Austenitic/Ferritic/Duplex)	110	0,003 x \varnothing Dc	0,003 x \varnothing Dc	0,003 x \varnothing Dc	0,003 x \varnothing Dc	0,002 x \varnothing Dc
K	Malleable Cast Iron	220	0,007 x \varnothing Dc	0,006 x \varnothing Dc	0,007 x \varnothing Dc	0,006 x \varnothing Dc	0,005 x \varnothing Dc
	Grey Cast Iron	210	0,007 x \varnothing Dc	0,006 x \varnothing Dc	0,007 x \varnothing Dc	0,006 x \varnothing Dc	0,005 x \varnothing Dc
	Nodular Cast Iron	190	0,006 x \varnothing Dc	0,005 x \varnothing Dc	0,006 x \varnothing Dc	0,005 x \varnothing Dc	0,005 x \varnothing Dc
S	Heat Resistant Super Alloys	60	0,003 x \varnothing Dc	0,003 x \varnothing Dc	0,003 x \varnothing Dc	0,003 x \varnothing Dc	0,002 x \varnothing Dc

HC40TSP = Corner chamfer, variable helix 40°-42° || Trochoidal Speed Cutting

P K

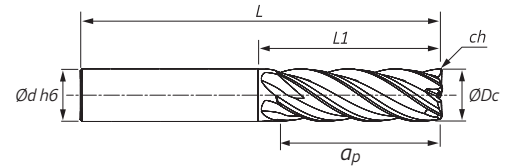

⁽¹⁾ Order code		Reference Referência Referencia	5	PHP920	Dimensions Dimensões Dimensiones (mm)					
HA (Cylindrical)	HB (Weldon)				ØDc	Ød (h6)	ap max	CH	L1	L
1180118T1	1180456T1	HC40TSPL 5 060 20	5	⊗	6	6	20	0,15 × 45°	26	60
1180119T1	1180457T1	HC40TSPL 5 080 25	5	⊗	8	8	25	0,15 × 45°	32	63
1180225T1	1180458T1	HC40TSPL 5 100 32	5	⊗	10	10	32	0,20 × 45°	38	79
1180690T1	1180689T1	HC40TSPL 5 120 41	5	⊗	12	12	41	0,20 × 45°	48	100
1180226T1	1180460T1	HC40TSPL 5 160 50	5	⊗	16	16	50	0,25 × 45°	56	110
1180123T1	1180461T1	HC40TSPL 5 180 60	5	⊗	18	18	60	0,30 × 45°	66	130
1180462T1	1180463T1	HC40TSPL 5 200 64	5	⊗	20	20	64	0,35 × 45°	70	130

⊗ Stock item | Produto de stock | Itens de stock

○ Available under request | Disponível sobre consulta
Disponível bajo consulta

Note: For HB (weldon) endmills, the reference ends with "-W"

RECOMMENDED CUTTING CONDITIONS || Condições de corte recomendadas | Condiciones de corte recomendables

ISO	Workpiece Material	fz (mm/t)			Vc (m/min)		
		ae (mm)			ae (mm)		
		5,0%	15%	30%	5,0%	15%	30%
P	Unalloyed Steel	0,009 × ØDc	0,009 × ØDc	0,008 × ØDc	180	170	170
	Low-Alloyed Steel	0,008 × ØDc	0,007 × ØDc	0,007 × ØDc	160	160	150
	High-Alloyed Steel	0,007 × ØDc	0,007 × ØDc	0,006 × ØDc	140	140	140
K	Malleable Cast Iron	0,009 × ØDc	0,009 × ØDc	0,008 × ØDc	210	210	200
	Grey Cast Iron	0,009 × ØDc	0,009 × ØDc	0,008 × ØDc	210	200	200
	Nodular Cast Iron	0,009 × ØDc	0,008 × ØDc	0,007 × ØDc	190	190	180

HC35ML Corner chamfer steel specialized endmills



Long



Variable Pitch
4



Variable Helix
35°/38°



Reduced
Neck Ø



45°
Corner chamfer



< 48 HRC

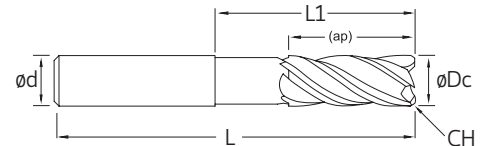

⁽¹⁾ Order code		Reference Referência Referencia		PHP920	Dimensions Dimensões Dimensiones (mm)					
HA (Cylindrical)	HB (Weldon)				ØDc	Ød (h6)	ap _{max}	CH	L1	L
1180480T1	-	HF35ML 4 010 03	4		1	6	2,5	-	5	57
1180482T1	1180483T1	HC35ML 4 020 05	4		2	6	5	0,07 x 45°	10	57
1180466T1	1180467T1	HC35ML 4 030 08	4		3	6	8	0,15 x 45°	15	57
1180137T1	1180468T1	HC35ML 4 040 11	4		4	6	11	0,15 x 45°	17	57
1180469T1	1180521T1	HC35ML 4 050 13	4		5	6	13	0,15 x 45°	19	57
1180138T1	1180470T1	HC35ML 4 060 13	4		6	6	13	0,15 x 45°	21	57
1180052T1	1180471T1	HC35ML 4 080 19	4		8	8	19	0,15 x 45°	27	63
1180053T1	1180472T1	HC35ML 4 100 22	4		10	10	22	0,20 x 45°	32	72
1180139T1	1180473T1	HC35ML 4 120 26	4		12	12	26	0,20 x 45°	38	83
1180474T1	1180475T1	HC35ML 4 140 26	4		14	14	26	0,25 x 45°	38	83
1180153T1	1180476T1	HC35ML 4 160 32	4		16	16	32	0,35 x 45°	44	92
1180477T1	1180478T1	HC35ML 4 180 32	4		18	18	32	0,45 x 45°	44	92
1180140T1	1180479T1	HC35ML 4 200 38	4		20	20	38	0,60 x 45°	54	104

Stock item | Produto de stock | Itens de stock

Available under request | Disponível sobre consulta
Disponível bajo consulta

Order code = (1) Geometry Code + (2) Grade Code

Note: For HB (Weldon) endmills, the reference ends with "-W"

Example: "HC35ML 4 030 08-W"

HR35GL Corner radius steel specialized endmills

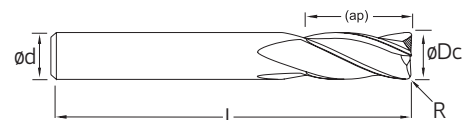

(1) Order code	Reference Referência Referencia	Flutes	PHP920	Dimensions Dimensões Dimensiones (mm)				
				ØDc	Ød (h6)	ap _{max}	R	L
1180042T1	HR35GL 4 120 26 R100	4	⊕	12	12	26	1	81
1180043T1	HR35GL 4 120 26 R200	4	⊕	12	12	26	2	81
1180044T1	HR35GL 4 120 26 R300	4	⊕	12	12	26	3	81
1180187T1	HR35GL 4 160 24 R100	4	⊕	16	16	24	1	100
1180188T1	HR35GL 4 160 24 R200	4	⊕	16	16	24	2	100
1180189T1	HR35GL 4 200 40 R100	4	⊕	20	20	40	1	100
1180190T1	HR35GL 4 200 40 R200	4	⊕	20	20	40	2	100

⊕ Stock item | Produto de stock | Itens de stock

○ Available under request | Disponível sobre consulta
Disponível bajo consulta

Order code = (1) Geometry Code + (2) Grade Code

CUTTING CONDITIONS | Condições de corte | Condiciones de corte

ISO	Material	fz (mm/t)			Vc (m/min)		
		a _e = 25%	a _e = 50%	a _e = 100%	a _e = 25%	a _e = 50%	a _e = 100%
P	Unalloyed Steel	0,008 × ØDc	0,005 × ØDc	0,004 × ØDc	190	180	150
	Low-Alloyed Steel	0,007 × ØDc	0,004 × ØDc	0,003 × ØDc	180	160	130
	High-Alloyed Steel	0,006 × ØDc	0,004 × ØDc	0,003 × ØDc	160	150	120
K	Malleable Cast Iron	0,008 × ØDc	0,005 × ØDc	0,004 × ØDc	230	210	180
	Grey Cast Iron	0,008 × ØDc	0,005 × ØDc	0,004 × ØDc	230	210	170
	Nodular Cast Iron	0,008 × ØDc	0,004 × ØDc	0,004 × ØDc	210	190	160

Note¹: Recommended feed values for maximum ap. For reduced ap, consider increasing Fz up to 25%.

Note²: Cutting speeds selected for an economic use of the tool, for higher productivity consider increasing up to 70%.

HC40SS Corner chamfer stainless steel specialized endmills



M

< 42 HRC

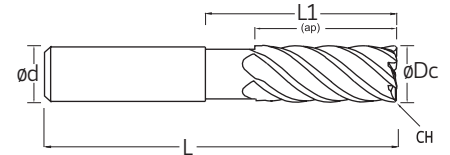

⁽¹⁾ Order code		Reference Referência Referencia	4	PHU920	Dimensions Dimensões Dimensiones (mm)					
HA (Cylindrical)	HB (Weldon)				ØDc	Ød (h6)	ap _{max}	CH	L1	L
1180484Z9	1180485Z9	HF40SS 4 010 03	4	○	1	6	2,5	-	5	57
1180380Z9	1180487Z9	HF40SS 4 020 05	4	○	2	6	5	-	10	57
1180381Z9	1180488Z9	HC40SS 4 030 08	4	⊗	3	6	8	0,15 × 45°	15	57
1180382Z9	1180489Z9	HC40SS 4 040 11	4	⊗	4	6	11	0,15 × 45°	17	57
1180383Z9	1180490Z9	HC40SS 4 050 13	4	⊗	5	6	13	0,15 × 45°	19	57
1180384Z9	1180389Z9	HC40SS 4 060 13	4	⊗	6	6	13	0,15 × 45°	21	57
1180329Z9	1180491Z9	HC40SS 4 080 19	4	⊗	8	8	19	0,15 × 45°	27	63
1180385Z9	1180492Z9	HC40SS 4 100 22	4	⊗	10	10	22	0,20 × 45°	32	72
1180386Z9	1180493Z9	HC40SS 4 120 26	4	⊗	12	12	26	0,20 × 45°	38	83
1180436Z9	1180494Z9	HC40SS 4 140 26	4	⊗	14	14	26	0,25 × 45°	38	83
1180387Z9	1180390Z9	HC40SS 4 160 32	4	⊗	16	16	32	0,35 × 45°	44	92
1180555Z9	1180556Z9	HC40SS 4 180 32	4	⊗	18	18	32	0,45 × 45°	44	92
1180388Z9	1180455Z9	HC40SS 4 200 38	4	⊗	20	20	38	0,60 × 45°	54	104

Stock item | Produto de stock | Itens de stock

Available under request | Disponível sobre consulta
Disponível bajo consulta

Order code = (1) Geometry Code + (2) Grade Code

CUTTING PARAMETERS | Parâmetros de corte | Parámetros de corte

ISO	Material	fz (mm/t)			Vc (m/min)		
		ae			ae		
		25%	50%	100%	25%	50%	100%
M	SS - Ferritic / Martensitic	0,007 × ØDc	0,004 × ØDc	0,003 × ØDc	160	150	120
	SS - Austenitic	0,006 × ØDc	0,004 × ØDc	0,003 × ØDc	140	130	100
	SS - Austenitic-ferritic (Duplex)	0,006 × ØDc	0,003 × ØDc	0,003 × ØDc	130	120	100

Note¹: Feed valid for when the endmill works with its whole ap, for when the endmill is working with lower depths of cut consider increasing the feed up to 25%.

Note²: Cutting speeds selected for an economic use of the tool, for higher productivity consider increasing up to 70%.

HRO40SS Rougher stainless steel specialized endmills



Short



4



Variable Helix
39°/41°



Reduced
Neck Ø



Rougher



45°
Corner chamfer

M



< 38 HRC

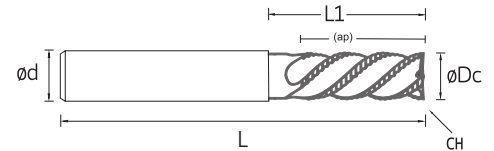

⁽¹⁾ Order code		Reference Referência Referencia		PHU920	Dimensions Dimensões Dimensiones (mm)					
HA (Cylindrical)	HB (Weldon)				ØDc	Ød (h6)	ap _{max}	CH	L1	L
1180445Z9	1180392Z9	HRO40SS 4 040 11	4		4	6	11	0,15 x 45°	17	57
1180446Z9	1180393Z9	HRO40SS 4 050 13	4		5	6	13	0,15 x 45°	19	57
1180447Z9	1180394Z9	HRO40SS 4 060 13	4		6	6	13	0,15 x 45°	21	57
1180448Z9	1180395Z9	HRO40SS 4 080 19	4		8	8	19	0,15 x 45°	27	63
1180391Z9	1180396Z9	HRO40SS 4 100 22	4		10	10	22	0,20 x 45°	32	72
1180449Z9	1180397Z9	HRO40SS 4 120 26	4		12	12	26	0,20 x 45°	38	83
1180450Z9	1180398Z9	HRO40SS 4 140 26	4		14	14	26	0,25 x 45°	38	83
1180451Z9	1180399Z9	HRO40SS 4 160 32	4		16	16	32	0,35 x 45°	44	92
1180452Z9	1180400Z9	HRO40SS 4 180 32	4		18	18	32	0,45 x 45°	44	92
1180453Z9	1180454Z9	HRO40SS 4 200 38	4		20	20	38	0,60 x 45°	54	104

Stock item | Produto de stock | Itens de stock

Available under request | Disponível sobre consulta
Disponível bajo consulta

Order code = (1) Geometry Code + (2) Grade Code

CUTTING PARAMETERS || Parâmetros de corte | Parámetros de corte

ISO	Material	Fz			Vc		
		ae			ae		
		25%	50%	100%	25%	50%	100%
M	SS - Ferritic / Martensitic	0,006 x ØDc	0,005 x ØDc	0,004 x ØDc	140	130	110
	SS - Austenitic	0,006 x ØDc	0,005 x ØDc	0,003 x ØDc	130	120	110
	SS - Austenitic-ferritic (Duplex)	0,005 x ØDc	0,004 x ØDc	0,003 x ØDc	120	110	100

Note¹: Feed valid for when the endmill works with its whole ap, for when the endmill is working with lower depths of cut consider increasing the feed up to 25%.

Note²: Cutting speeds selected for an economic use of the tool, for higher productivity consider increasing up to 70%.

HC38AS 3 Corner chamfer aluminium specialized endmills

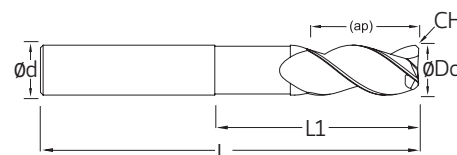

⁽¹⁾ Order code		Reference Referência Referencia		Dimensions Dimensões Dimensiones (mm)						
HA (Cylindrical)	HB (Weldon)			ØDc	Ød (h6)	ap _{max}	CH	L1	L	
1180401T2	1180410T2	HC38AS 3 030 07	3		3	6	7	0,15 x 45°	15	57
1180402T2	1180411T2	HC38AS 3 040 08	3		4	6	8	0,15 x 45°	17	57
1180403T2	1180412T2	HC38AS 3 050 10	3		5	6	10	0,15 x 45°	19	57
1180404T2	1180413T2	HC38AS 3 060 10	3		6	6	10	0,15 x 45°	21	57
1180405T2	1180414T2	HC38AS 3 080 16	3		8	8	16	0,15 x 45°	27	63
1180406T2	1180415T2	HC38AS 3 100 19	3		10	10	19	0,20 x 45°	32	72
1180407T2	1180416T2	HC38AS 3 120 22	3		12	12	22	0,20 x 45°	38	83
1180408T2	1180417T2	HC38AS 3 160 26	3		16	16	26	0,35 x 45°	44	92
1180409T2	1180418T2	HC38AS 3 200 32	3		20	20	32	0,60 x 45°	54	104

Stock item | Produto de stock | Itens de stock

Available under request | Disponível sobre consulta
Disponível bajo consulta

Order code = (1) Geometry Code + (2) Grade Code

Note: For HB (Weldon) endmills, the reference ends with "-W"
Example: "HC38AS 3 030 07-W PH0920"

CUTTING CONDITIONS | Condições de corte | Condiciones de corte

ISO	Material	f _z (mm/t)			V _c (m/min)		
		a _e = 25%	a _e = 50%	a _e = 100%	a _e = 25%	a _e = 50%	a _e = 100%
N	Alluminium <6%Si	0,011 x ØDc	0,009 x ØDc	0,006 x ØDc	230	220	190
	Alluminium <12%Si	0,009 x ØDc	0,008 x ØDc	0,005 x ØDc	210	200	180
	Alluminium >12%Si	0,008 x ØDc	0,007 x ØDc	0,005 x ØDc	200	190	170

Note¹: Recommended feed values for maximum a_p. For reduced a_p, consider increasing f_z up to 25%.

Note²: Cutting speeds selected for an economic use of the tool, for higher productivity consider increasing up to 70%.

HF30AS Single edge aluminium endmills



N

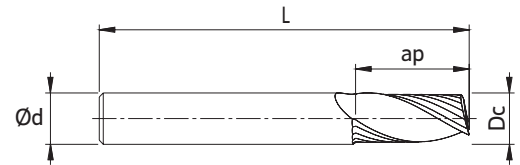

(1) Order code	Reference Referência Referencia		PH0920				
				ØDc	Ød (h6)	ap _{max}	L
118075112	HF30AS 1 020 05	1		2	6	5	57
118075212	HF30AS 1 030 08	1		3	6	8	57
118075312	HF30AS 1 040 11	1		4	6	11	57
118075412	HF30AS 1 050 13	1		5	6	13	57
118075512	HF30AS 1 060 13	1		6	6	13	57
118075612	HF30AS 1 080 19	1		8	8	19	63
118075712	HF30AS 1 100 25	1		10	10	22	72
118075812	HF30AS 1 120 26	1		12	12	26	83

Stock item | Produto de stock | Itens de stock

Available under request | Disponível sobre consulta
Disponível bajo consulta

Order code = (1) Geometry Code + (2) Grade Code

CUTTING CONDITIONS | Condições de corte | Condiciones de corte

ISO	Material	f _z (mm/t)			V _c (m/min)		
		a _e = 25%	a _e = 50%	a _e = 100%	a _e = 25%	a _e = 50%	a _e = 100%
N	Alluminium <6%Si	0,011 x ØDc	0,009 x ØDc	0,006 x ØDc	230	220	190
	Alluminium <12%Si	0,009 x ØDc	0,008 x ØDc	0,005 x ØDc	210	200	180
	Alluminium >12%Si	0,008 x ØDc	0,007 x ØDc	0,005 x ØDc	200	190	170

Note¹: Recommended feed values for maximum ap. For reduced ap, consider increasing f_z up to 25%.

Note²: Cutting speeds selected for an economic use of the tool, for higher productivity consider increasing up to 70%.

HF30HL Flat top endmill for hard materials

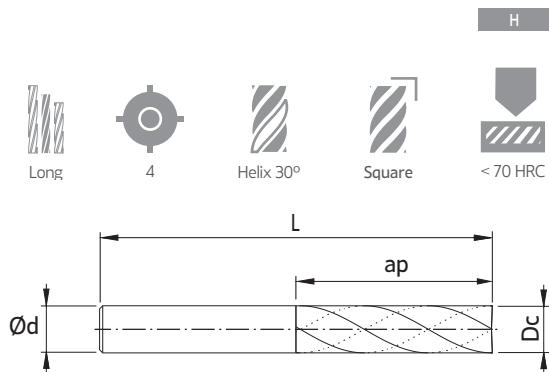

(1) Order code	Reference Referência Referencia		PHH603				
				$\varnothing Dc$	$\varnothing d (h6)$	ap_{max}	L
1180112X4	HF30HL 4 040 20	4		4	6	20	75
1180358X4	HF30HL 4 050 20	4		5	6	20	75
1180196X4	HF30HL 4 060 30	4		6	6	30	75
1180113X4	HF30HL 4 080 35	4		8	8	35	100
1180359X4	HF30HL 4 100 40	4		10	10	40	100
1180111X4	HF30HL 4 120 50	4		12	12	50	100

Stock item | Produto de stock | Itens de stock

Available under request | Disponível sobre consulta
Disponível bajo consulta

Order code = (1) Geometry Code + (2) Grade Code

HB30HL Ball nose endmill for hard materials

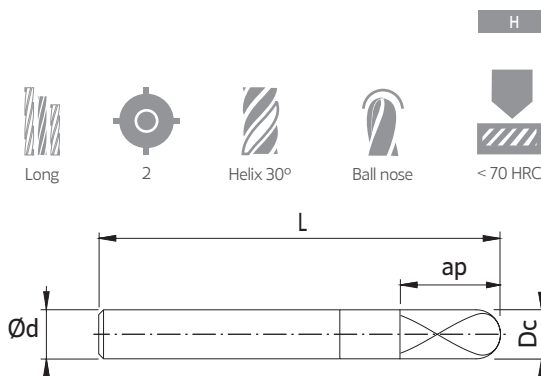

(1) Order code	Reference Referência Referencia		PHH603				
				$\varnothing d_c$	$\varnothing d$ (h6)	$a_{p \max}$	L
1180356X4	HB30HL 2 020 04	2		2	6	4	75
1180357X4	HB30HL 2 030 06	2		3	6	6	75
1180093X4	HB30HL 2 040 08	2		4	6	8	75
1180109X4	HB30HL 2 050 10	2		5	6	10	75
1180130X4	HB30HL 2 060 12	2		6	6	12	75
1180131X4	HB30HL 2 080 16	2		8	8	16	75
1180132X4	HB30HL 2 100 20	2		10	10	20	100
1180141X4	HB30HL 2 120 24	2		12	12	24	100

Stock item | Produto de stock | Itens de stock

Available under request | Disponível sobre consulta
Disponível bajo consulta

Order code = (1) Geometry Code + (2) Grade Code

CUTTING PARAMETERS || Parâmetros de corte | Parámetros de corte

ISO	Material	Vc		fz	
		10%	30%	10%	30%
H	Hardened Steels	120	110	0,006 x $\varnothing d_c$	0,005 x $\varnothing d_c$

INTEG GRADES

COATINGS

PHP

- Unmatched coating adhesion;
- Smoothest surface;
- Suitable for dry and wet machining;
- Color: Black;



Product of the latest coating technology, the PHP is the number one coating for machining steel and cast iron. Because of its smoothness at medium temperatures, the chips are able to flow effortlessly, maintaining the flutes clean and a long tool life even in dry conditions.

PHH

- Highest thermal stability;
- Smooth surface;
- High performance in dry machining;
- Color: Light brown;



A prime coating for prime endmills, the PHH is the recommended coating for Hardened steels, as well as stainless steels and HRSA.

Because of its high performance at high temperatures the coating successfully protect the cutting edges allowing the tool to work for long periods of time.

PHU

- High thermal shock resistance;
- Carefully engineered surface quality;
- Suitable for dry and wet machining;
- Color: Grey;

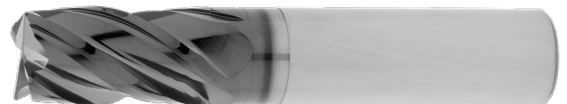

Combining both excellent thermal resistance and excellent surface quality, the PHU coating is recommended for stainless steels, while also being suitable for steels and cast iron.

Because of its surface quality and thermal resistance it is able to prevent built-up-edge in both low-alloy steels and stainless steels, making it a very versatile coating.

SUBSTRATE

PH...920

Universal substrate with great balance between toughness and wear resistance;
Outstanding heat dissipation properties;
Recommended for semi-finishing to roughing on most materials;

PH...603

Harder grade with extreme wear resistance;
Excellent thermal stability;
Recommended for finishing applications and Hardened steels;

SOLID CARBIDE TROUBLESHOOTING

A
MILLING
Overview
Face milling
Hi-feed milling
Shoulder milling
Profile milling
Hardmill
Center & Chamfer
Spot face
Spare Parts
Technical Data
End Mills

Trouble Problema	Cause Causa Fuente	Possible Solution Solução Solución
Breaking of tool Quebra da ferramenta Ruptura de la herramienta	<ul style="list-style-type: none"> At time of engaging with work material No início da maquinação Al principio del mecanizado 	<ul style="list-style-type: none"> 1. Decrease feed rate. 2. Decrease projection amount. 3. Shorten cutting edge length to required minimum limit.
	<ul style="list-style-type: none"> When ending cut No final da maquinação Al final del mecanizado 	<ul style="list-style-type: none"> 1. Diminuir a taxa de avanço. 2. Diminuir quantidade de projeção. 3. Encurtar comprimento da aresta de corte para limite mínimo exigido.
	<ul style="list-style-type: none"> During normal cutting Durante o corte normal Durante el corte normal 	<ul style="list-style-type: none"> 1. Decrease feed rate. 2. Control wear - replace tool early. 3. Replace chuck or collet. 4. Decrease projection amount. 5. Carry out honing. 6. If 4 flute, reduce to 2 flute (clogging of chipping). 7. If dry cutting change to wet cutting utilize cutting fluid. In case of wet cutting flow oil supplied from the front, change to from rear angle of side top. Use ample with rate.
	<ul style="list-style-type: none"> When changing direction of feed Ao mudar do direcção do avanço Al cambiar la dirección de avance 	<ul style="list-style-type: none"> 1. Diminuir a taxa de avanço. 2. Controlar desgaste - substituir ferramenta atempadamente. 3. Substitua mandril ou porta-pinça. 4. Diminuir quantidade de projeção 5. Criar boleamento 6. Se tiver 4 navalhas, reduzir para 2 (obstrução da apara). 7. Se utilizou corte seco alterar para corte com utilização de fluido. No caso de utilização de fluido frontal, alterar para utilização do fornecimento do fluido pela parte traseira.
Fracture of cutting edge Fratura da aresta de corte Fractura de la arista de corte	<ul style="list-style-type: none"> Fracture of corners Fratura dos cantos Fratura dos cantos 	<ul style="list-style-type: none"> 1. Utilize circular interpolation (in case of NC machine) or temporarily stop feed (Dowelling). 2. Reduce feed rate before and after change of directions. 3. Replace chuck or collect.
	<ul style="list-style-type: none"> Fracture at boundary of depth of cut Fratura no limite de profundidade de corte Fractura en el límite de profundidad de corte 	<ul style="list-style-type: none"> 1. Utilização de interpolação helicoidal (no caso de máquina CNC). 2. Reduzir avanço antes ou depois de mudar de direcção. 3. Substitua mandril ou porta-pinças.
	<ul style="list-style-type: none"> Chipping at center part or overall Esmilhar na parte central ou global Astillado en parte central o general 	<ul style="list-style-type: none"> 1. Utilización de interpolación helicoidal (para máquina CNC). 2. Reducir avance antes o después de cambiar de dirección. 3. Reemplace plato o el portaherramienta.
	<ul style="list-style-type: none"> Fracture of corners Fratura dos cantos Fratura dos cantos 	<ul style="list-style-type: none"> 1. Carry out chamfering or nose with hand lapper. 2. Down cut - Up cut.
Fracture of cutting edge Fratura da aresta de corte Fractura de la arista de corte	<ul style="list-style-type: none"> Fracture of corners Fratura dos cantos Fratura dos cantos 	<ul style="list-style-type: none"> 1. Criar chanfro. 2. Corte inferior - Corte Superior.
	<ul style="list-style-type: none"> Fracture at boundary of depth of cut Fratura no limite de profundidade de corte Fractura en el límite de profundidad de corte 	<ul style="list-style-type: none"> 1. Criar chanfro. 2. Corte inferior - Corte Superior.
	<ul style="list-style-type: none"> Chipping at center part or overall Esmilhar na parte central ou global Astillado en parte central o general 	<ul style="list-style-type: none"> 1. Down cut - Up cut. 2. Reduce cutting speed.
	<ul style="list-style-type: none"> Fracture of corners Fratura dos cantos Fratura dos cantos 	<ul style="list-style-type: none"> 1. Corte inferior - Corte Superior. 2. Reduzir velocidade de corte.
Fracture of cutting edge Fratura da aresta de corte Fractura de la arista de corte	<ul style="list-style-type: none"> Fracture of corners Fratura dos cantos Fratura dos cantos 	<ul style="list-style-type: none"> 1. Carry out honing or enlarge. 2. Change number of rotation (in case machine vibrates). 3. Increase cutting speed. 4. In ease of squeaking noise during cutting, increase feed. 5. If dry cutting use cutting fluid or blow air. 6. Replace chuck or collet. 7. Reduce cutting speed.
	<ul style="list-style-type: none"> Chipping at center part or overall Esmilhar na parte central ou global Astillado en parte central o general 	<ul style="list-style-type: none"> 1. Criar ou aumentar boleamento. 2. Alterar rotação (no caso da maquina vibrar). 3. Aumentar velocidade de corte. 4. No caso de barulho de esmagamento durante o corte, aumentar avanço. 5. Se estiver a maquina a seco, utilizar fluido de corte ou ar comprimido. 6. Substitua mandril ou porta-pinça. 7. Reduzir velocidade de corte.
	<ul style="list-style-type: none"> Fracture of corners Fratura dos cantos Fratura dos cantos 	<ul style="list-style-type: none"> 1. Criar o aumentar redondeo. 2. Cambie la rotación (en el caso de la máquina vibrar). 3. Aumento de la velocidad de corte. 4. En el caso de ruido de trituración durante el corte, aumentar avance. 5. Si mecanizado en seco, utilizar un fluido de corte o aire comprimido. 6. Reemplace plato o el portaherramienta. 7. Reducir la velocidad de corte.
	<ul style="list-style-type: none"> Fracture of corners Fratura dos cantos Fratura dos cantos 	<ul style="list-style-type: none"> 1. Decrease feed rate. 2. If 4 flute reduce to 2 flute. 3. Carry out honing or enlarge. 4. Replace chuck or collet. 5. Reduce cutting speed. 6. If dry cutting, change to wet cutting. In case oil supply in wet cutting is from the front, change to rear at an angle or from side top. Use ample supply.
<ul style="list-style-type: none"> Large fracturing of cutting edge Grande fratura da aresta de corte Gran fractura de la arista de corte 	<ul style="list-style-type: none"> 1. Diminuir a taxa de avanço. 2. Se tiver 4 navalhas, reduzir para 2 (obstrução da apara). 3. Criar ou aumentar boleamento. 4. Substitua mandril ou porta-pinça. 5. Reduzir velocidade de corte. 6. Se utilizou corte seco alterar para corte com utilização de fluido. No caso de utilização de fluido frontal, alterar para utilização do fornecimento do fluido pela parte traseira. Use amplo fornecimento de fluido de corte. 	
<ul style="list-style-type: none"> Large fracturing of cutting edge Grande fratura da aresta de corte Gran fractura de la arista de corte 	<ul style="list-style-type: none"> 1. Disminuir la velocidad de avance. 2. Si 4 hélices, reducir a 2 hélices (obstrucción de viruta) 3. Crear o aumentar redondeo. 4. Reemplace plato o el portaherramienta. 5. Reducir la velocidad de corte. 6. Si se utiliza corte en seco cambie para corte con uso del fluido. En caso de el uso de frente de fluido cambie para suministro de fluido desde la parte trasera. Utilice amplio suministro. 	

Trouble Problema	Cause Causa Fuente	Possible Solution Solução Solución
Rapid tool wear Desgaste prematuro da ferramenta Desgaste prematuro de la herramienta		<ul style="list-style-type: none"> 1. Reduce cutting speed. 2. Up cut - Down cut 3. Increase feed. 4. Utilize wet cutting or air. 5. If reground tool, improve surface roughness of flank. <ul style="list-style-type: none"> 1. Reducir la velocidad de corte. 2. Corte Superior - Corte Inferior. 3. Aumentar avanço. 4. Utilize fluido de corte ou ar comprimido. 5. Se utilizar uma ferramenta afiada, melhora a rugosidade da superfície ou flanco. <ul style="list-style-type: none"> 1. Reducir la velocidad de corte. 2. Corte Superior - Corte Inferior. 3. Aumento del avance. 4. Utilice corte en mojado o el aire comprimido. 5. Se utiliza una herramienta afilada, mejora la rugosidad de la superficie o arista.
Inferior finished surface Fraco acabamento da superfície Acabado superficial deficiente	<ul style="list-style-type: none"> • Surface is good but rough • Superfície boa mas irregular • Buena superficie, pero irregular <ul style="list-style-type: none"> • Small chip welding • Soldadura de pequenas aparas • Soldadura de pequeñas virutas <ul style="list-style-type: none"> • With transverse streaks • Com as raías transversais • Con rayas transversales <ul style="list-style-type: none"> • Signs of excessive cutting • Sinais de corte excessivo • Señales de corte excesivo 	<ul style="list-style-type: none"> 1. Decrease feed. 2. In case using 2 flute, increase to 4 flute. <ul style="list-style-type: none"> 1. Diminuir avanço. 2. No caso de usar 2 hélices, aumentar para 4. <ul style="list-style-type: none"> 1. Reducir avance. 2. En caso de utilizar 2 fillos de corte, aumentar para 4. <ul style="list-style-type: none"> 1. Increase cutting speed. 2. Utilize wet cutting air blow (ample supply). 3. Carry out fine honing. 4. Up cut - Down cut. 5. Increase feed or enlarge finish allowance. <ul style="list-style-type: none"> 1. Aumente velocidade de corte. 2. Utilize fluido de corte e ar comprimido. 3. Aumentar boleamento. 4. Corte Superior - Corte Inferior. 5. Aumento o avanço ou alargue as tolerâncias no acabamento. <ul style="list-style-type: none"> 1. Aumento de la velocidad de corte. 2. Utilice fluidos de corte y aire comprimido. 3. Aumentar redondeo. 4. Corte Superior - Corte Inferior. 5. Aumente el avance o ampliación de las tolerancias en el acabado. <ul style="list-style-type: none"> 1. Carry out fine honing. 2. Use water insoluble cutting fluid. 3. Down cut - Up cut. <ul style="list-style-type: none"> 1. Aumentar boleamento. 2. Utilize fluidos de corte. 3. Corte Inferior - Corte Superior. <ul style="list-style-type: none"> 1. Aumentar redondeo. 2. Utilice fluidos de corte. 3. Corte Inferior - Corte Superior. <ul style="list-style-type: none"> 1. Reduce finishing depth of cut. 2. Increase cutting speed. 3. Reduce feed. <ul style="list-style-type: none"> 1. Reduzir profundidade de corte no acabamento. 2. Aumente velocidade de corte. 3. Diminuir avanço. <ul style="list-style-type: none"> 1. Reducir la profundidad de corte en el acabado. 2. Aumento de la velocidad de corte. 3. Reducir avance.
Poor machining accuracy Fraca precisão na maquinação Pobre precisión en el mecanizado	<ul style="list-style-type: none"> • Finish dimensions are on minus side • Dimensões do acabamento estão inferiores ao previsto • Las dimensiones del acabado están terminando abajo de lo esperado <ul style="list-style-type: none"> • Poor perpendicularity • Fraca perpendicularidade • Fraca perpendicularidade 	<ul style="list-style-type: none"> 1. Up cut - Down cut. 2. Reduce finishing depth of cut. 3. Replace chuck or collet. 4. Reduce projection amount. 5. Increase cutting speed. <ul style="list-style-type: none"> 1. Corte Superior - Corte Inferior. 2. Reduzir profundidade de corte no acabamento. 3. Substitua mandril ou porta-piça. 4. Diminuir quantidade de projeção. 5. Aumentar velocidade de corte. <ul style="list-style-type: none"> 1. Corte Superior - Corte Inferior. 2. Reducir la profundidad de corte en el acabado. 3. Reemplace plato o el portaherramienta. 4. Disminuir la cantidad de proyección. 5. Aumento de la velocidad de corte. <ul style="list-style-type: none"> 1. Reduce finishing depth of cut. 2. Replace chuck or collet. 3. Reduce projection amount. 4. Increase cutting speed. 5. 2 Flute - 4 Flute. 6. Reduce feed. 7. Check wear rate - Replace tool. <ul style="list-style-type: none"> 1. Reduzir profundidade de corte no acabamento. 2. Substitua mandril ou porta-piça. 3. Diminuir quantidade de projeção. 4. Aumentar velocidade de corte. 5. 2 hélices - 4 hélices. 6. Diminuir avanço. 7. Verifique o desgaste - Substitua a ferramenta. <ul style="list-style-type: none"> 1. Reducir la profundidad de corte en el acabado. 2. Reemplace plato o el portaherramienta. 3. Disminuir la cantidad de proyección. 4. Aumento de la velocidad de corte. 5. 2 hélices - 4 hélices. 6. Reducir avance. 7. Revise el desgaste Reemplace la herramienta.
		<ul style="list-style-type: none"> 1. Increase feed rate (in case over 0.05 mm/Zahn, try reducing). 2. Change cutting speed. 3. Replace chuck or collet. 4. Reduce projection amount. 5. Use 2 flute cutter for rough cutting and 4 flute for finishing. 6. Down cut - Up cut. <ul style="list-style-type: none"> 1. Aumente o avanço (no caso de mais de 0,05 mm / Zahn, tente reduzir). 2. Alterar velocidade de corte. 3. Substitua mandril ou porta-piça. 4. Diminuir quantidade de projeção. 5. Usar 2 hélices para desbaste e 4 para acabamento. 6. Corte Inferior - Corte Superior. <ul style="list-style-type: none"> 1. Aumento del avance (en caso de más de 0,05 mm / Zahn, intente reducir). 2. Cambie de la velocidad de corte. 3. Reemplace plato o el portaherramienta. 4. Disminuir la cantidad de proyección. 5. Utilice 2 fillos de corte para desbaste y 4 para acabado. 6. Corte Inferior - Corte Superior.

A

MILLING

Overview

Face milling

Hi-feed milling

Shoulder milling

Profile milling

Hardmill

Center & Chamfer

Spot face

Spare Parts

Technical Data

End Mills



B - DRILLING

B - 298 | Drills code key

B - 300 | Nomenclature

B - 301 | Overview

B



DRILLING



B - 302 | JET DRILLS

B - 312 | INTEGRIX DRILLS

B - 321 | TREPANNING DRILLS

B - 322 | SOLID CARBIDE DRILLS

B - 332 | Inserts code key

B - 334 | Inserts

B - 336 | Spare Parts

B - 346 | Technical Data

DRILLS CODE KEY

DRILLING

T D S

Drill group

2 1 5

Drilling diameter: $\varnothing 21,5$

2 5 - 3 D

Shank diameter: $\varnothing 25$

Drilling depth: Dia x 3

DRILLING

Jet Drills

T D C

Drill group

7 5 8 0

Drilling diameter: $\varnothing 70$ until $\varnothing 80$

4 0 - 3 D

Shank diameter: $\varnothing 40$

Drilling depth: Dia x 3

Integrex Drills

S C S

Drill group

2 5 5

Drilling diameter: $\varnothing 55$

3 2 - 3 D

Shank diameter: $\varnothing 32$

Drilling depth: Dia x 3

Vortex Drills

S C C

Drill group

6 0 6 5

Drilling diameter: $\varnothing 60$ until $\varnothing 65$

4 0 - 4 D

Shank diameter: $\varnothing 40$

Drilling depth: Dia x 4

Trepanning Drills

D H S

Drill group

0 0 4 0

Drilling diameter: $\varnothing 40$

3 2 - 5 D

Shank diameter: $\varnothing 32$

Drilling depth: Dia x 5

Solid Carbide Drills

D H C

Drill group

7 0 7 5

Drilling diameter: $\varnothing 70$ until $\varnothing 75$

4 0 - 8 D

Shank diameter: $\varnothing 40$

Drilling depth: Dia x 8

Inserts

Spare Parts

T F D

Drill group

2 9 0

Drilling diameter: $\varnothing 29,0$

3 2 - 8 D

Shank diameter: $\varnothing 32$

Drilling depth: Dia x 8

Technical Data

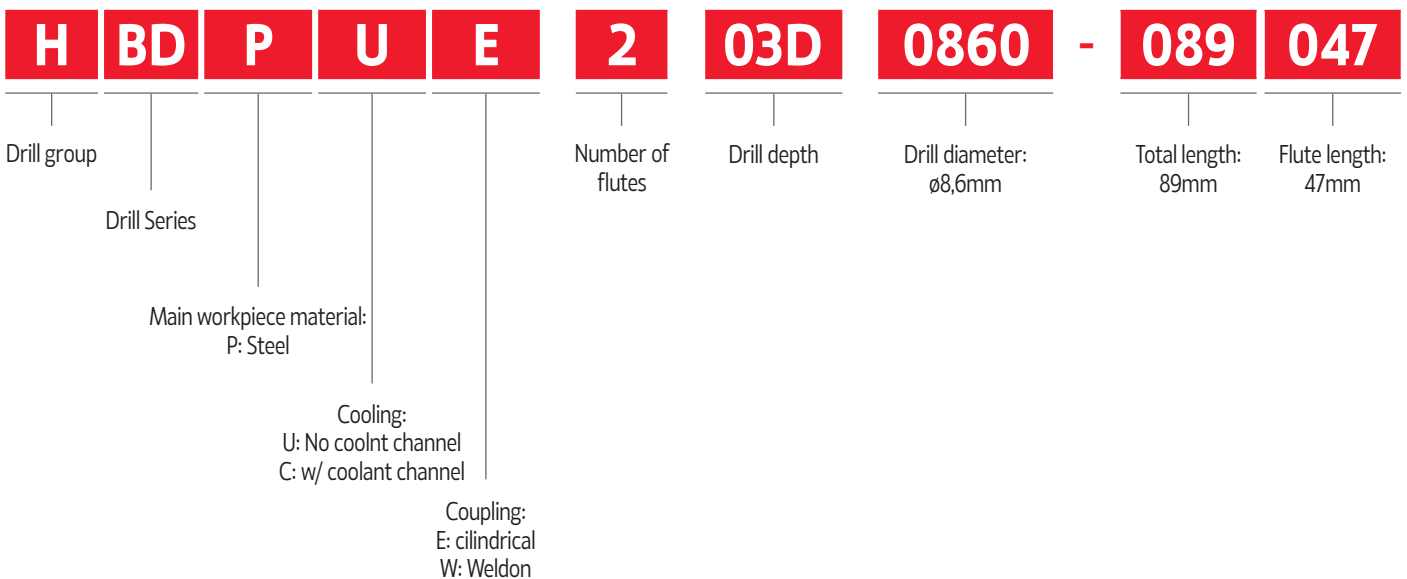
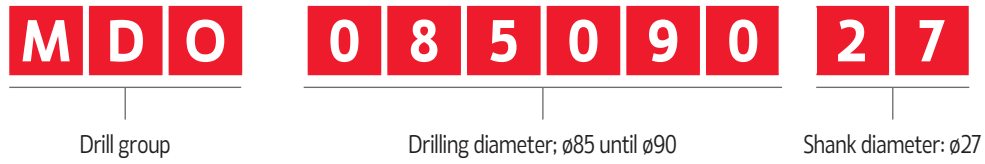

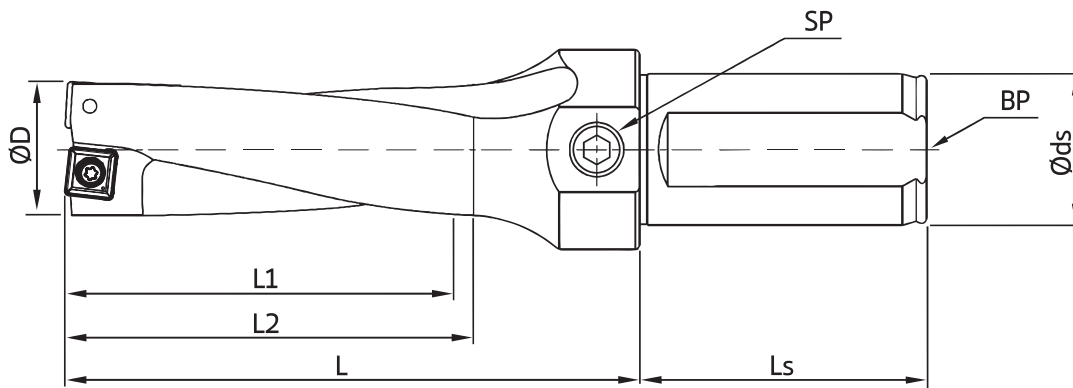

ØD - Drill diameter

L - Length

L1 - Cut length

SP - Side plug

Øds - Shank diameter

Ls - Shank Length

L2 - Safety cut length

BP - Back plug

COOLANT SUPPLY | Furos de refrigeração | Agujeros de refrigeración

New version / Standard version*

Type	BP	SP
TDS	✓ / ✓	✗ / ✓
TDC	✓ / ✓	✓ / ✓
SCS	✓ / ✓	✗ / ✓
SCC	✓ / ✓	✓ / ✓
DHS	✓ / ✓	✗ / ✓
DHC	✓ / ✓	✗ / ✓
TFD	✓ / ✓	✓ / ✓
MDO	✓ / ✓	✓ / ✓
PND	✓ / ✓	✓ / ✓







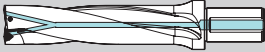

BP - Back Plug

SP - Side Plug

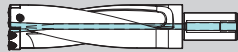
✓ - Available

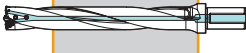

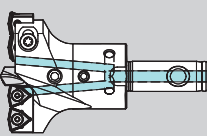
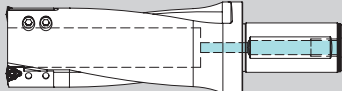

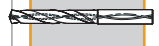

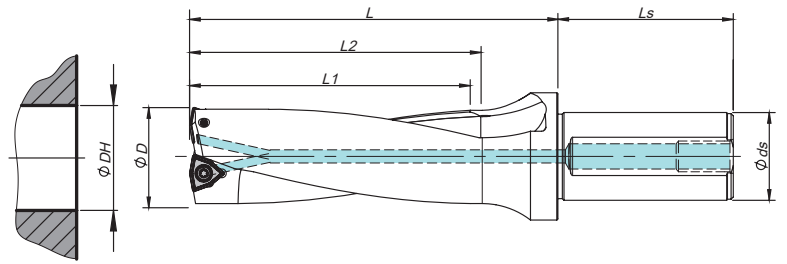























✗ - Not Available

* The new Drill version will replace the standard version when this type will be sold out.

		Diameter (mm)									
		03	12	20	32	50	60	70	80	110	... 180
Jet Drills				 <p>TDS 3D Drill L1 max = 174mm</p>							
				 <p>SCS Drill (3D-4D) L1 max = 200mm</p>				 <p>TDC 3D Drill L1 max = 240mm</p>			
						 <p>SCC Drill (3D-4D) L1 max = 320mm</p>					
Integrex Drills				 <p>DHS Drill (6D-8D) L1 max = 300mm</p>							
						 <p>DHC Drill (5D-8D) L1 max = 640mm</p>					
				 <p>TFD Drill (6D-8D) L1 max = 240mm</p>							
Vortex Drills							 <p>Vortex Drill L1 max = 900mm</p>				
Trepanning Drills							 <p>PND Drill L1 max = 250mm</p>				
Solid Carbide Drills		 <p>HBDP ... SC Drill (3D-5D) L1 max = 101mm</p>									
		 <p>HBDP ... SC Drill (8D) L1 max = 162mm</p>									











































Øds	Ls	BP / SP	ØDH tolerance (mm)	
			ØD	3D
20	50	PT-1/8	13,0 - 21,5	-0,10 / +0,15
25	56	PT-1/8	22,0 - 50,0	-0,12 / +0,20
32	60	PT-1/4	50,0 - 58,0	-0,15 / +0,25
40	70	PT-1/4		

Order code Código	Reference Referência Referencia	Dimensions Dimensões Dimensiones (mm)					Insert	Insert Screw 	Torx key 	Stock 
		ØD	Ø ds	L1	L2	L				
184034600	TDS 13020-3D	13,0	20	39	42	62	WCKX 02T104	P0180500	XT06	
184034700	TDS 13520-3D	13,5	20	41	44	64	WCKX 02T104	P0180500	XT06	
184034800	TDS 14020-3D	14,0	20	42	45	65	WCKX 02T104	P0180500	XT06	
184034900	TDS 14520-3D	14,5	20	44	47	67	WCKX 02T104	P0180500	XT06	
184035000	TDS 15020-3D	15,0	20	45	48	68	WCKX 02T104	P0180500	XT06	
184035100	TDS 15520-3D	15,5	20	47	50	70	WCKX 02T104	P0180500	XT06	
184035200	TDS 16025-3D	16,0	25	48	51	76	WCKX 030204	P0220500	XT07	
184035300	TDS 16525-3D	16,5	25	50	53	78	WCKX 030204	P0220500	XT07	
184035400	TDS 17025-3D	17,0	25	51	54	79	WCKX 030204	P0220500	XT07	
184035500	TDS 17525-3D	17,5	25	53	56	81	WCKX 030204	P0220500	XT07	
184035600	TDS 18025-3D	18,0	25	54	57	82	WCKX 030204	P0220500	XT07	
184035700	TDS 18525-3D	18,5	25	56	59	84	WCKX 030204	P0220500	XT07	
184035800	TDS 19025-3D	19,0	25	57	60	85	WCKX 030204	P0220500	XT07	
184035900	TDS 19525-3D	19,5	25	59	62	87	WCKX 030204	P0220500	XT07	
184036000	TDS 20025-3D	20,0	25	60	63	88	WCKX 030204	P0220500	XT07	
184036100	TDS 20525-3D	20,5	25	62	65	90	WCKX 040204	P0250503	XT08	
184036200	TDS 21025-3D	21,0	25	63	66	91	WCKX 040204	P0250503	XT08	
184036300	TDS 21525-3D	21,5	25	65	68	93	WCKX 040204	P0250503	XT08	
184036400	TDS 22025-3D	22,0	25	66	69	94	WCKX 040204	P0250503	XT08	
184036500	TDS 22525-3D	22,5	25	68	71	96	WCKX 040204	P0250503	XT08	
184036600	TDS 23025-3D	23,0	25	69	72	97	WCKX 040204	P0250503	XT08	
184036700	TDS 23525-3D	23,5	25	71	74	99	WCKX 040204	P0250503	XT08	
184036800	TDS 24025-3D	24,0	25	72	75	100	WCKX 040204	P0250503	XT08	
184036900	TDS 24525-3D	24,5	25	74	77	102	WCKX 040204	P0250503	XT08	
184037000	TDS 25025-3D	25,0	25	75	78	103	WCKX 040204	P0250503	XT08	
184037100	TDS 25532-3D	25,5	32	77	80	110	WCKX 050308	P0300701	XT08	
184037200	TDS 26032-3D	26,0	32	78	81	111	WCKX 050308	P0300701	XT08	

 Stock item | Produto de stock | Itens de stock

 Available under request | Disponível sobre consulta | Disponible bajo consulta

Order code Código	Reference Referência Referencia	Dimensions Dimensões Dimensiones (mm)					Insert	Insert Screw 	Torx key 	Stock 
		ØD	Ø ds	L1	L2	L				
184037300	TDS 26532-3D	26,5	32	80	83	113	WCKX 050308	P0300701	XT08	
184037400	TDS 27032-3D	27,0	32	81	84	114	WCKX 050308	P0300701	XT08	
184037500	TDS 27532-3D	27,5	32	83	86	116	WCKX 050308	P0300701	XT08	
184037600	TDS 28032-3D	28,0	32	84	87	117	WCKX 050308	P0300701	XT08	
184037700	TDS 28532-3D	28,5	32	86	89	119	WCKX 050308	P0300701	XT08	
184037800	TDS 29032-3D	29,0	32	87	90	120	WCKX 050308	P0300701	XT08	
184037900	TDS 29532-3D	29,5	32	89	92	122	WCKX 050308	P0300701	XT08	
184038000	TDS 30032-3D	30,0	32	90	93	123	WCKX 050308	P0300701	XT08	
184038100	TDS 31032-3D	31,0	32	93	96	126	WCKX 06T308	P0350903	XT15	
184038200	TDS 32032-3D	32,0	32	96	99	129	WCKX 06T308	P0350903	XT15	
184038300	TDS 33032-3D	33,0	32	99	102	132	WCKX 06T308	P0350903	XT15	
184038400	TDS 34032-3D	34,0	32	102	105	135	WCKX 06T308	P0350903	XT15	
184038500	TDS 35032-3D	35,0	32	105	108	138	WCKX 06T308	P0350903	XT15	
184038600	TDS 36032-3D	36,0	32	108	111	141	WCKX 06T308	P0350903	XT15	
184038700	TDS 37032-3D	37,0	32	111	114	144	WCKX 06T308	P0350903	XT15	
184038800	TDS 38032-3D	38,0	32	114	117	147	WCKX 06T308	P0350903	XT15	
184038900	TDS 39032-3D	39,0	32	117	120	150	WCKX 06T308	P0350903	XT15	
184039000	TDS 40032-3D	40,0	32	120	123	153	WCKX 06T308	P0350903	XT15	
184039100	TDS 41032-3D	41,0	32	123	126	156	WCKX 06T308	P0350903	XT15	
184039200	TDS 42040-3D	42,0	40	126	129	164	WCKX 080408	P0401101	XT15	
184039300	TDS 43040-3D	43,0	40	129	132	167	WCKX 080408	P0401101	XT15	
184039400	TDS 44040-3D	44,0	40	132	135	170	WCKX 080408	P0401101	XT15	
184039500	TDS 45040-3D	45,0	40	135	138	173	WCKX 080408	P0401101	XT15	
184039600	TDS 46040-3D	46,0	40	138	141	176	WCKX 080408	P0401101	XT15	
184039700	TDS 47040-3D	47,0	40	141	144	179	WCKX 080408	P0401101	XT15	
184039800	TDS 48040-3D	48,0	40	144	147	182	WCKX 080408	P0401101	XT15	
184039900	TDS 49040-3D	49,0	40	147	150	185	WCKX 080408	P0401101	XT15	
184040000	TDS 50040-3D	50,0	40	150	153	188	WCKX 080408	P0401101	XT15	
184040100	TDS 51040-3D	51,0	40	153	156	191	WCKX 080408	P0401101	XT15	
184040200	TDS 52040-3D	52,0	40	156	159	194	WCKX 080408	P0401101	XT15	
184040300	TDS 53040-3D	53,0	40	159	162	197	WCKX 080408	P0401101	XT15	
184040400	TDS 54040-3D	54,0	40	162	165	200	WCKX 080408	P0401101	XT15	
184040500	TDS 55040-3D	55,0	40	165	168	203	WCKX 080408	P0401101	XT15	
184040600	TDS 56040-3D	56,0	40	168	171	206	WCKX 080408	P0401101	XT15	
184040700	TDS 57040-3D	57,0	40	171	174	209	WCKX 080408	P0401101	XT15	
184040800	TDS 58040-3D	58,0	40	174	177	212	WCKX 080408	P0401101	XT15	

 Stock item | Produto de stock | Itens de stock

 Available under request | Disponível sobre consulta | Disponible bajo consulta

TDC 3D CARTRIDGE TYPE (DOUBLE INSERT) | Jet drills | Brocas jet | Brocas jet

DRILLING

Jet Drills

Integrex Drills

Vortex Drills

Trepanning Drills

Solid Carbide Drills

Inserts

Spare Parts

Technical Data

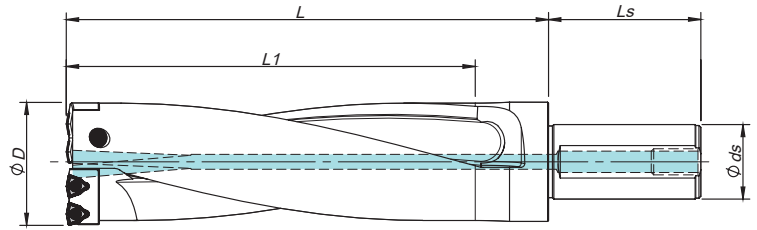

Øds	Ls	BP / SP
40	70	PT - 1/4







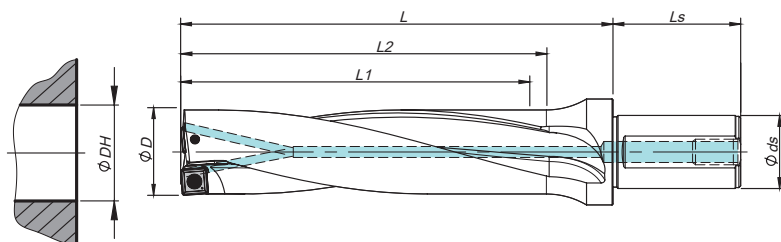























Order code Código	Reference Referência Referencia	Dimensions Dimensões Dimensiones (mm)					Insert	Insert Screw	Torx key	Stock
		ØD	Ø ds	L1	L	Cartridge				
184040900	TDC 596540-3D	59-65	40	195	235	TDC 059065-I/O	WCKX 06T308	P0350903	XT15	☺
184041000	TDC 657040-3D	65-70	40	210	250	TDC 065070-I/O	WCKX 06T308	P0350903	XT15	☺
184041100	TDC 707540-3D	70-75	40	225	265	TDC 070075-I/O	WCKX 06T308	P0350903	XT15	☺
184041200	TDC 758040-3D	75-80	40	240	280	TDC 075080-I/O	WCKX 06T308	P0350903	XT15	☺

☺ Stock item | Produto de stock | Itens de stock

○ Available under request | Disponível sobre consulta | Disponible bajo consulta

































Øds	Ls	BP / SP	ØDH tolerance (mm)	
20	50	PT -1/8	ØD	3D
25	56	PT -1/8	13,0 - 21,5	-0,10 / +0,15
32	60	PT -1/4	22,0 - 50,0	-0,12 / +0,20
40	70	PT -1/4		

Order code Código	Reference Referência Referencia	Dimensions Dimensões Dimensiones (mm)					Insert	Insert Screw 	Torx key 	Stock 
		ØD	Ø ds	L1	L2	L				
184041400	SCS 13020-3D	13,0	20	39	42	62	SPKX 050204	P0200500	XT06	
184041500	SCS 13520-3D	13,5	20	41	44	64	SPKX 050204	P0200500	XT06	
184041600	SCS 14020-3D	14,0	20	42	45	65	SPKX 050204	P0200500	XT06	
184041700	SCS 14520-3D	14,5	20	44	47	67	SPKX 050204	P0200500	XT06	
184041800	SCS 15020-3D	15,0	20	45	48	68	SPKX 050204	P0200500	XT06	
184041900	SCS 15525-3D	15,5	25	47	50	75	SPKX 060204	P0220500	XT07	
184042000	SCS 16025-3D	16,0	25	48	51	76	SPKX 060204	P0220500	XT07	
184042100	SCS 16525-3D	16,5	25	50	53	78	SPKX 060204	P0220500	XT07	
184042200	SCS 17025-3D	17,0	25	51	54	79	SPKX 060204	P0220500	XT07	
184042300	SCS 17525-3D	17,5	25	53	56	81	SPKX 060204	P0220500	XT07	
184042400	SCS 18025-3D	18,0	25	54	57	82	SPKX 060204	P0220500	XT07	
184042500	SCS 18525-3D	18,5	25	56	59	84	SPKX 060204	P0220500	XT07	
184042600	SCS 19025-3D	19,0	25	57	60	85	SPKX 060204	P0220500	XT07	
184042700	SCS 19525-3D	19,5	25	59	62	87	SPKX 060204	P0220500	XT07	
184042800	SCS 20025-3D	20,0	25	60	63	88	SPKX 060204	P0220500	XT07	
184042900	SCS 20525-3D	20,5	25	62	65	90	SPKX 060204	P0220500	XT07	
184043000	SCS 21025-3D	21,0	25	63	66	91	SPKX 060204	P0220500	XT07	
184043100	SCS 21525-3D	21,5	25	65	68	93	SPKX 060204	P0220500	XT07	
184043200	SCS 22032-3D	22,0	32	66	69	99	SPKX 07T308	P0250704	XT08	
184043300	SCS 22532-3D	22,5	32	68	71	101	SPKX 07T308	P0250704	XT08	
184043400	SCS 23032-3D	23,0	32	69	72	102	SPKX 07T308	P0250704	XT08	
184043500	SCS 23532-3D	23,5	32	71	74	104	SPKX 07T308	P0250704	XT08	
184043600	SCS 24032-3D	24,0	32	72	75	105	SPKX 07T308	P0250704	XT08	
184043700	SCS 24532-3D	24,5	32	74	77	107	SPKX 07T308	P0250704	XT08	
184043800	SCS 25032-3D	25,0	32	75	78	108	SPKX 07T308	P0250704	XT08	
184043900	SCS 25532-3D	25,5	32	77	80	110	SPKX 07T308	P0250704	XT08	
184044000	SCS 26032-3D	26,0	32	78	81	111	SPKX 07T308	P0250704	XT08	

 Stock item | Produto de stock | Itens de stock

 Available under request | Disponível sobre consulta | Disponible bajo consulta

DRILLING
Jet Drills
Integrex Drills
Vortex Drills
Trepanning Drills
Solid Carbide Drills
Inserts
Spare Parts
Technical Data







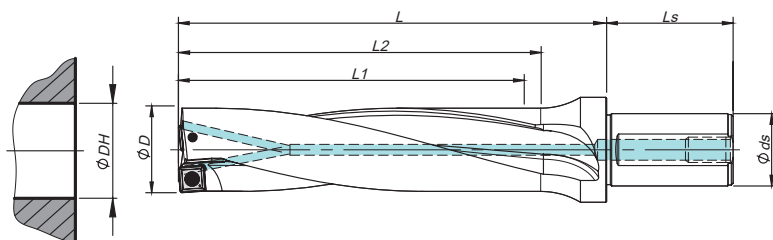























Order code Código	Reference Referência Referencia	Dimensions Dimensões Dimensiones (mm)					Insert	Insert Screw 	Torx key 	Stock 
		ØD	Ø ds	L1	L2	L				
184044100	SCS 26532-3D	26,5	32	80	83	113	SPKX 07T308	P0250704	XT08	
184044200	SCS 27032-3D	27,0	32	81	84	114	SPKX 07T308	P0250704	XT08	
184044400	SCS 27532-3D	27,5	32	83	86	116	SPKX 07T308	P0250704	XT08	
184044500	SCS 28032-3D	28,0	32	84	87	117	SPKX 090408	P0350903	XT15	
184044600	SCS 28532-3D	28,5	32	86	89	119	SPKX 090408	P0350903	XT15	
184044700	SCS 29032-3D	29,0	32	87	90	120	SPKX 090408	P0350903	XT15	
184044800	SCS 29532-3D	29,5	32	89	93	123	SPKX 090408	P0350903	XT15	
184044900	SCS 30032-3D	30,0	32	90	95	125	SPKX 090408	P0350903	XT15	
184045000	SCS 31032-3D	31,0	32	93	98	128	SPKX 090408	P0350903	XT15	
184045100	SCS 32032-3D	32,0	32	96	101	131	SPKX 090408	P0350903	XT15	
184045200	SCS 33032-3D	33,0	32	99	104	134	SPKX 090408	P0350903	XT15	
184045300	SCS 34040-3D	34,0	40	102	107	142	SPKX 110408	P0401200	XT15	
184045400	SCS 35040-3D	35,0	40	105	110	145	SPKX 110408	P0401200	XT15	
184045500	SCS 36040-3D	36,0	40	108	113	148	SPKX 110408	P0401200	XT15	
184045600	SCS 37040-3D	37,0	40	111	116	151	SPKX 110408	P0401200	XT15	
184045700	SCS 38040-3D	38,0	40	114	119	154	SPKX 110408	P0401200	XT15	
184045800	SCS 39040-3D	39,0	40	117	122	157	SPKX 110408	P0401200	XT15	
184045900	SCS 40040-3D	40,0	40	120	125	160	SPKX 110408	P0401200	XT15	
184046000	SCS 41040-3D	41,0	40	123	128	163	SPKX 110408	P0401200	XT15	
184046100	SCS 42040-3D	42,0	40	126	131	166	SPKX 140512	P0501300	XT20	
184046200	SCS 43040-3D	43,0	40	129	134	169	SPKX 140512	P0501300	XT20	
184046300	SCS 44040-3D	44,0	40	132	137	172	SPKX 140512	P0501300	XT20	
184046400	SCS 45040-3D	45,0	40	135	140	175	SPKX 140512	P0501300	XT20	
184046500	SCS 46040-3D	46,0	40	138	143	178	SPKX 140512	P0501300	XT20	
184046600	SCS 47040-3D	47,0	40	141	146	181	SPKX 140512	P0501300	XT20	
184046700	SCS 48040-3D	48,0	40	144	149	184	SPKX 140512	P0501300	XT20	
184046800	SCS 49040-3D	49,0	40	147	152	187	SPKX 140512	P0501300	XT20	
184046900	SCS 50040-3D	50,0	40	150	155	190	SPKX 140512	P0501300	XT20	

 Stock item | Produto de stock | Itens de stock

 Available under request | Disponível sobre consulta | Disponible bajo consulta

































Øds	Ls	BP / SP	ØDH tolerance (mm)	
			ØD	4D
20	50	PT -1/8	13,0 - 21,5	-0,15 / +0,20
25	56	PT -1/8	22,0 - 50,0	-0,15 / +0,25
32	60	PT -1/4		
40	70	PT -1/4		

Order code Código	Reference Referência Referencia	Dimensions Dimensões Dimensiones (mm)					Insert	Insert Screw 	Torx key 	Stock 
		ØD	Ø ds	L1	L2	L				
184047100	SCS 13020-4D	13,0	20	52	55	75	SPKX 050204	P0200500	XT06	
184047200	SCS 13520-4D	13,5	20	54	57	77	SPKX 050204	P0200500	XT06	
184047300	SCS 14020-4D	14,0	20	56	59	79	SPKX 050204	P0200500	XT06	
184047400	SCS 14520-4D	14,5	20	58	61	81	SPKX 050204	P0200500	XT06	
184047500	SCS 15020-4D	15,0	20	60	63	83	SPKX 050204	P0200500	XT06	
184047600	SCS 15525-4D	15,5	25	62	65	90	SPKX 060204	P0220500	XT07	
184047700	SCS 16025-4D	16,0	25	64	67	92	SPKX 060204	P0220500	XT07	
184047800	SCS 16525-4D	16,5	25	66	69	94	SPKX 060204	P0220500	XT07	
184047900	SCS 17025-4D	17,0	25	68	71	96	SPKX 060204	P0220500	XT07	
184048000	SCS 17525-4D	17,5	25	70	73	98	SPKX 060204	P0220500	XT07	
184048100	SCS 18025-4D	18,0	25	72	75	100	SPKX 060204	P0220500	XT07	
184048200	SCS 18525-4D	18,5	25	74	77	102	SPKX 060204	P0220500	XT07	
184048300	SCS 19025-4D	19,0	25	76	79	104	SPKX 060204	P0220500	XT07	
184048400	SCS 19525-4D	19,5	25	78	81	106	SPKX 060204	P0220500	XT07	
184048500	SCS 20025-4D	20,0	25	80	83	108	SPKX 060204	P0220500	XT07	
184048600	SCS 20525-4D	20,5	25	82	85	110	SPKX 060204	P0220500	XT07	
184048700	SCS 21025-4D	21,0	25	84	87	112	SPKX 060204	P0220500	XT07	
184048800	SCS 21525-4D	21,5	25	86	89	114	SPKX 060204	P0220500	XT07	
184048900	SCS 22032-4D	22,0	32	88	91	121	SPKX 07T308	P0250704	XT08	
184049000	SCS 22532-4D	22,5	32	90	93	123	SPKX 07T308	P0250704	XT08	
184049100	SCS 23032-4D	23,0	32	92	95	125	SPKX 07T308	P0250704	XT08	
184049200	SCS 23532-4D	23,5	32	94	97	127	SPKX 07T308	P0250704	XT08	
184049300	SCS 24032-4D	24,0	32	96	99	129	SPKX 07T308	P0250704	XT08	
184049400	SCS 24532-4D	24,5	32	98	101	131	SPKX 07T308	P0250704	XT08	
184049500	SCS 25032-4D	25,0	32	100	103	133	SPKX 07T308	P0250704	XT08	
184049600	SCS 25532-4D	25,5	32	102	105	135	SPKX 07T308	P0250704	XT08	
184049700	SCS 26032-4D	26,0	32	104	107	137	SPKX 07T308	P0250704	XT08	

 Stock item | Produto de stock | Itens de stock

 Available under request | Disponível sobre consulta | Disponible bajo consulta

DRILLING
Jet Drills
Integrex Drills
Vortex Drills
Trepanning Drills
Solid Carbide Drills
Inserts
Spare Parts
Technical Data

Order code Código	Reference Referência Referencia	Dimensions Dimensões Dimensiones (mm)					Insert	Insert Screw	Torx key	Stock
		ØD	Ø ds	L1	L2	L				
184049800	SCS 26532-4D	26,5	32	106	109	139	SP... 07T308	P0250704	XT08	
184049900	SCS 27032-4D	27,0	32	108	111	141	SP... 07T308	P0250704	XT08	
184050000	SCS 27532-4D	27,5	32	110	113	143	SP... 07T308	P0250704	XT08	
184050100	SCS 28032-4D	28,0	32	112	115	145	SP... 090408	P0350903	XT15	
184050200	SCS 28532-4D	28,5	32	114	117	147	SP... 090408	P0350903	XT15	
184050300	SCS 29032-4D	29,0	32	116	120	150	SP... 090408	P0350903	XT15	
184050400	SCS 29532-4D	29,5	32	118	123	153	SP... 090408	P0350903	XT15	
184050500	SCS 30032-4D	30,0	32	120	125	155	SP... 090408	P0350903	XT15	
184050600	SCS 31032-4D	31,0	32	124	129	159	SP... 090408	P0350903	XT15	
184050700	SCS 32032-4D	32,0	32	128	133	163	SP... 090408	P0350903	XT15	
184050800	SCS 33032-4D	33,0	32	132	137	167	SP... 090408	P0350903	XT15	
184050900	SCS 34040-4D	34,0	40	136	141	176	SP... 110408	P0401200	XT15	
184051000	SCS 35040-4D	35,0	40	140	145	180	SP... 110408	P0401200	XT15	
184051100	SCS 36040-4D	36,0	40	144	149	184	SP... 110408	P0401200	XT15	
184051200	SCS 37040-4D	37,0	40	148	153	188	SP... 110408	P0401200	XT15	
184051300	SCS 38040-4D	38,0	40	152	157	192	SP... 110408	P0401200	XT15	
184051400	SCS 39040-4D	39,0	40	156	161	196	SP... 110408	P0401200	XT15	
184051500	SCS 40040-4D	40,0	40	160	165	200	SP... 110408	P0401200	XT15	
184051600	SCS 41040-4D	41,0	40	164	169	204	SP... 110408	P0401200	XT15	
184051700	SCS 42040-4D	42,0	40	168	173	208	SP... 140512	P0501300	XT20	
184051800	SCS 43040-4D	43,0	40	172	177	212	SP... 140512	P0501300	XT20	
184051900	SCS 44040-4D	44,0	40	176	181	216	SP... 140512	P0501300	XT20	
184052000	SCS 45040-4D	45,0	40	180	185	220	SP... 140512	P0501300	XT20	
184052100	SCS 46040-4D	46,0	40	184	189	224	SP... 140512	P0501300	XT20	
184052200	SCS 47040-4D	47,0	40	188	193	228	SP... 140512	P0501300	XT20	
184052300	SCS 48040-4D	48,0	40	192	197	232	SP... 140512	P0501300	XT20	
184052400	SCS 49040-4D	49,0	40	196	201	236	SP... 140512	P0501300	XT20	
184052500	SCS 50040-4D	50,0	40	200	205	240	SP... 140512	P0501300	XT20	

 Stock item | Produto de stock | Itens de stock







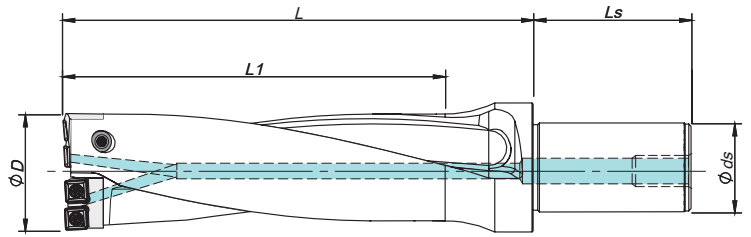

 Available under request | Disponível sobre consulta | Disponible bajo consulta

SCC 3D CARTRIDGE TYPE (DOUBLE INSERT) | Jet drills | Brocas jet | Brocas jet

Size adaptable cartridge (5mm)



Øds	Ls	BP / SP
40	70	PT - 1/4

Order code Código	Reference Referência Referencia	Dimensions Dimensões Dimensiones (mm)				Cartridge	Insert	Insert Screw 	Torx key 	Stock
		ØD	Ø ds	L1	L					
184231800	SCC 505540-3D	50-55	40	165	205	SCC 050055-I/O	SPKX 090408	P0350903	XT15	
184231900	SCC 556040-3D	55-60	40	180	220	SCC 055060-I/O	SPKX 090408	P0350903	XT15	
184232000	SCC 606540-3D	60-65	40	195	235	SCC 060065-I/O	SPKX 110408	P0401200	XT15	
184232100	SCC 657040-3D	65-70	40	210	250	SCC 065070-I/O	SPKX 110408	P0401200	XT15	
184232200	SCC 707540-3D	70-75	40	225	265	SCC 070075-I/O	SPKX 110408	P0401200	XT15	
184232300	SCC 758040-3D	75-80	40	240	278	SCC 075080-I/O	SPKX 140512	P0501300	XT20	

 Stock item | Produto de stock | Itens de stock

 Available under request | Disponível sobre consulta | Disponible bajo consulta

3D

DRILLING

Jet Drills

Integrex Drills

Vortex Drills

Trepanning Drills

Solid Carbide Drills

Inserts

Spare Parts

Technical Data

SCC 4D CARTRIDGE TYPE (DOUBLE INSERT) | Jet drills | Brocas jet | Brocas jet

Size adaptable cartridge (5mm)

DRILLING

Jet Drills

Integrex Drills

Vortex Drills

Trepanning Drills

Solid Carbide Drills







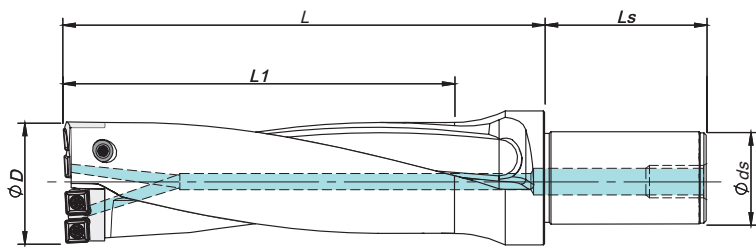

Inserts

Spare Parts

Technical Data



Øds	Ls	BP / SP
40	70	PT - 1/4

Order code Código	Reference Referência Referencia	Dimensions Dimensões Dimensiones (mm)				Cartridge	Insert	Insert Screw 	Torx key 	Stock
		ØD	Ø ds	L1	L					
184232400	SCC 505540-4D	50-55	40	220	260	SCC 050055-I/O	SPKX 090408	P0350903	XT15	
184232500	SCC 556040-4D	55-60	40	240	280	SCC 055060-I/O	SPKX 090408	P0350903	XT15	
184232600	SCC 606540-4D	60-65	40	260	300	SCC 060065-I/O	SPKX 110408	P0401200	XT15	
184232700	SCC 657040-4D	65-70	40	280	320	SCC 065070-I/O	SPKX 110408	P0401200	XT15	
184232800	SCC 707540-4D	70-75	40	300	340	SCC 070075-I/O	SPKX 110408	P0401200	XT15	
184232900	SCC 758040-4D	75-80	40	320	358	SCC 075080-I/O	SPKX 140512	P0501300	XT20	

 Stock item | Produto de stock | Itens de stock

 Available under request | Disponível sobre consulta | Disponible bajo consulta

SCC 4D CARTRIDGE TYPE (DOUBLE INSERT) | Jet drills | Brocas jet | Brocas jet

Size adjustment cartridge (1mm)

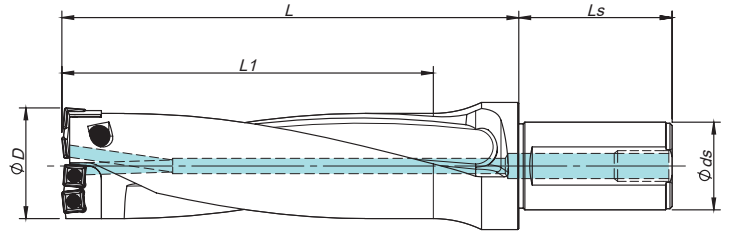

Øds	Ls	BP / SP
40	70	PT - 1/4

Order code Código	Reference Referência Referencia	Dimensions Dimensões Dimensiones (mm)				Cartridge	Insert	Insert Screw 	Torx key 	Stock
		ØD	Ø ds	L1	L					
184056100	SCC 555640-4D	55-56	40	235	275	CISP 5560 / COSP 5556	SPKX 090408	P0350903	XT15	⊕
184056300	SCC 575840-4D	57-58	40	235	275	CISP 5560 / COSP 5758	SPKX 090408	P0350903	XT15	⊕
184056400	SCC 585940-4D	58-59	40	235	275	CISP 5560 / COSP 5859	SPKX 090408	P0350903	XT15	⊕
184056500	SCC 596040-4D	59-60	40	235	275	CISP 5560 / COSP 5960	SPKX 090408	P0350903	XT15	⊕
184057100	SCC 656640-4D	65-66	40	275	315	CISP 6570 / COSP 6566	SPKX 110408	P0401200	XT15	⊕
184057200	SCC 666740-4D	66-67	40	275	315	CISP 6570 / COSP 6667	SPKX 110408	P0401200	XT15	⊕
184057300	SCC 676840-4D	67-68	40	275	315	CISP 6570 / COSP 6768	SPKX 110408	P0401200	XT15	⊕
184057400	SCC 686940-4D	68-69	40	275	315	CISP 6570 / COSP 6869	SPKX 110408	P0401200	XT15	⊕
184057500	SCC 697040-4D	69-70	40	275	315	CISP 6570 / COSP 6970	SPKX 110408	P0401200	XT15	⊕
184058400	SCC 787940-4D	78-79	40	315	355	CISP 7580 / COSP 7879	SPKX 140512	P0501300	XT20	⊕
184058500	SCC 798040-4D	79-80	40	315	355	CISP 7580 / COSP 7980	SPKX 140512	P0501300	XT20	⊕

⊕ Stock item | Produto de stock | Itens de stock
○ Available under request | Disponível sobre consulta | Disponible bajo consulta
⊕ Available until sold out | Disponível até acabar o stock | Disponible hasta acabar el stock

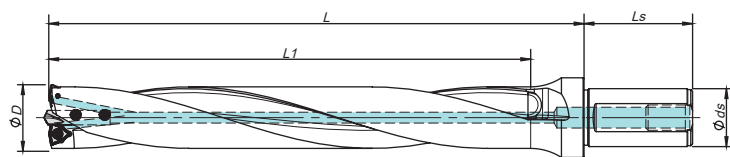

* The new Drill version will replace the standard version when this type will be sold out.



New version / Standard version*

Øds	Ls	BP / SP
32	60 / 70	PT - 1/4

Order separately

Order code Código	Reference Referência Referencia	Dimensions Dimensões Dimensiones (mm)				Insert	Insert Screw 	Torx key 	Pilot drill 	Stock
		ØD	Ø ds	L1	L					
184058600	DHS 002532-5D	25	32	150	180	WCKX 030204	P0220500	XT07	MDP 3006	○
184058700	DHS 002632-5D	26	32	150	180	WCKX 040204	P0250503	XT08	MDP 3006	○
184058800	DHS 002732-5D	27	32	150	180	WCKX 040204	P0250503	XT08	MDP 3006	○
184058900	DHS 002832-5D	28	32	150	180	WCKX 040204	P0250503	XT08	MDP 3006	○
184059000	DHS 002932-5D	29	32	150	180	WCKX 040204	P0250503	XT08	MDP 3006	○
184059100	DHS 003032-5D	30	32	150	180	WCKX 040204	P0250503	XT08	MDP 3006	○
184059200	DHS 003132-5D	31	32	175	205	WCKX 050308	P0300701	XT08	MDP 3508	○
184059300	DHS 003232-5D	32	32	175	205	WCKX 050308	P0300701	XT08	MDP 3508	○
184059400	DHS 003332-5D	33	32	175	205	WCKX 050308	P0300701	XT08	MDP 3508	○
184059500	DHS 003432-5D	34	32	175	205	WCKX 050308	P0300701	XT08	MDP 3508	○
184059600	DHS 003532-5D	35	32	175	205	WCKX 050308	P0300701	XT08	MDP 3508	○
184059700	DHS 003632-5D	36	32	200	230	WCKX 050308	P0300701	XT08	MDP 3508	○
184059800	DHS 003732-5D	37	32	200	230	WCKX 050308	P0300701	XT08	MDP 3508	○
184059900	DHS 003832-5D	38	32	200	230	WCKX 050308	P0300701	XT08	MDP 3508	○
184060000	DHS 003932-5D	39	32	200	230	WCKX 050308	P0300701	XT08	MDP 3508	○
184060100	DHS 004032-5D	40	32	200	230	WCKX 050308	P0300701	XT08	MDP 3508	○

Stock item | Produto de stock | Itens de stock
 Available under request | Disponível sobre consulta | Disponible bajo consulta

Note: This type of drills are supplied without pilot drills. Please order them separately.

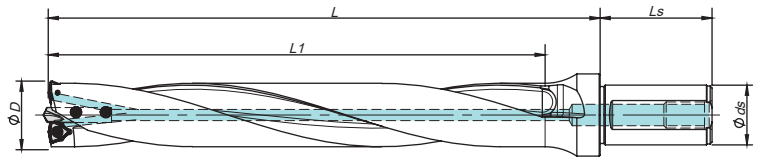

Please see Page B - 315 for setting pilot drill.



New version / Standard version*

Øds	Ls	BP / SP
32	60 / 70	PT - 1/4

Order separatly

Order code Código	Reference Referência Referencia	Dimensions Dimensões Dimensiones (mm)				Insert	Insert Screw 	Torx key 	Pilot drill 	Stock
		ØD	Ø ds	L1	L					
184062100	DHS 002532-8D	25	32	220	250	WCKX 030204	P0220500	XT07	MDP 3006	☉
184062200	DHS 002632-8D	26	32	220	250	WCKX 040204	P0250503	XT08	MDP 3006	○
184062300	DHS 002732-8D	27	32	220	250	WCKX 040204	P0250503	XT08	MDP 3006	○
184062400	DHS 002832-8D	28	32	220	250	WCKX 040204	P0250503	XT08	MDP 3006	○
184062500	DHS 002932-8D	29	32	220	250	WCKX 040204	P0250503	XT08	MDP 3006	○
184062600	DHS 003032-8D	30	32	220	250	WCKX 040204	P0250503	XT08	MDP 3006	☉
184062700	DHS 003132-8D	31	32	260	290	WCKX 050308	P0300701	XT08	MDP 3508	○
184062800	DHS 003232-8D	32	32	260	290	WCKX 050308	P0300701	XT08	MDP 3508	○
184062900	DHS 003332-8D	33	32	260	290	WCKX 050308	P0300701	XT08	MDP 3508	○
184063000	DHS 003432-8D	34	32	260	290	WCKX 050308	P0300701	XT08	MDP 3508	○
184063100	DHS 003532-8D	35	32	260	290	WCKX 050308	P0300701	XT08	MDP 3508	☉
184063200	DHS 003632-8D	36	32	300	330	WCKX 050308	P0300701	XT08	MDP 3508	○
184063300	DHS 003732-8D	37	32	300	330	WCKX 050308	P0300701	XT08	MDP 3508	○
184063400	DHS 003832-8D	38	32	300	330	WCKX 050308	P0300701	XT08	MDP 3508	○
184063500	DHS 003932-8D	39	32	300	330	WCKX 050308	P0300701	XT08	MDP 3508	○
184063600	DHS 004032-8D	40	32	300	330	WCKX 050308	P0300701	XT08	MDP 3508	☉

☉ Stock item | Produto de stock | Itens de stock ○ Available under request | Disponível sobre consulta | Disponible bajo consulta

Note: This type of drills are supplied without pilot drills. Please order them separately.

Please see Page B - 315 for setting pilot drill.

DHC 5D CARTRIDGE TYPE (SINGLE & DOUBLE INSERT)

Integrex drills | Brocas integrex | Brocas integrex

DRILLING
Jet Drills
Integrex Drills
Vortex Drills
Trepanning Drills
Solid Carbide Drills
Inserts
Spare Parts
Technical Data

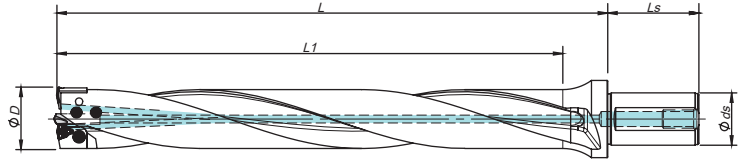

New version / Standard version*

Øds	Ls	BP / SP
40	70 / 80	PT - 1/4

Order separately

Order code Código	Reference Referência Referencia	Dimensions Dimensões Dimensiones (mm)				Cartridge	Insert	Insert Screw	Torx key	Pilot drill	Stock
		ØD	Ø ds	L1	L						
184192500	DHC 004140-5D	41	40	225	260	CWC 041045-I / CWC 000041-O	WCKX 06T308	P0350903	XT15	MDP 3510	○
184192600	DHC 004240-5D	42	40	225	260	CWC 041045-I / CWC 000042-O	WCKX 06T308	P0350903	XT15	MDP 3510	○
184192700	DHC 004340-5D	43	40	225	260	CWC 041045-I / CWC 000043-O	WCKX 06T308	P0350903	XT15	MDP 3510	○
184192800	DHC 004440-5D	44	40	225	260	CWC 041045-I / CWC 000044-O	WCKX 06T308	P0350903	XT15	MDP 3510	○
184192900	DHC 004540-5D	45	40	225	260	CWC 041045-I / CWC 000045-O	WCKX 06T308	P0350903	XT15	MDP 3510	○
184193000	DHC 004640-5D	46	40	250	285	CWC 046050-I / CWC 000046-O	WCKX 06T308	P0350903	XT15	MDP 3510	○
184193100	DHC 004740-5D	47	40	250	285	CWC 046050-I / CWC 000047-O	WCKX 06T308	P0350903	XT15	MDP 3510	○
184193200	DHC 004840-5D	48	40	250	285	CWC 046050-I / CWC 000048-O	WCKX 06T308	P0350903	XT15	MDP 3510	○
184193300	DHC 004940-5D	49	40	250	285	CWC 046050-I / CWC 000049-O	WCKX 06T308	P0350903	XT15	MDP 3510	○
184193400	DHC 005040-5D	50	40	250	285	CWC 046050-I / CWC 000050-O	WCKX 06T308	P0350903	XT15	MDP 3510	○
184193500	DHC 005140-5D	51	40	275	310	CWC 051055-I / CWC 000051-O	WCKX 080408	P0401101	XT15	MDP 3812	○
184193600	DHC 005240-5D	52	40	275	310	CWC 051055-I / CWC 000052-O	WCKX 080408	P0401101	XT15	MDP 3812	○
184193700	DHC 005340-5D	53	40	275	310	CWC 051055-I / CWC 000053-O	WCKX 080408	P0401101	XT15	MDP 3812	○
184193800	DHC 005440-5D	54	40	275	310	CWC 051055-I / CWC 000054-O	WCKX 080408	P0401101	XT15	MDP 3812	○
184193900	DHC 005540-5D	55	40	275	310	CWC 051055-I / CWC 000055-O	WCKX 080408	P0401101	XT15	MDP 3812	○
184194000	DHC 005640-5D	56	40	300	335	CWC 056059-I / CWC 000056-O	WCKX 080408	P0401101	XT15	MDP 3812	○
184194100	DHC 005740-5D	57	40	300	335	CWC 056059-I / CWC 000057-O	WCKX 080408	P0401101	XT15	MDP 3812	○
184194200	DHC 005840-5D	58	40	300	335	CWC 056059-I / CWC 000058-O	WCKX 080408	P0401101	XT15	MDP 3812	○
184194300	DHC 005940-5D	59	40	300	335	CWC 056059-I / CWC 000059-O	WCKX 080408	P0401101	XT15	MDP 3812	○
2 INSERTS PER CARTRIDGE											
184065600	DHC 606540-5D	60-65	40	325	360	MDC 060065-I/O	WCKX 050308	P0300701	XT08	MDP 3812	○
184065700	DHC 657040-5D	65-70	40	350	385	MDC 065070-I/O	WCKX 050308	P0300701	XT08	MDP 3812	○
184065800	DHC 707540-5D	70-75	40	375	410	MDC 070075-I/O	WCKX 050308	P0300701	XT08	MDP 3812	○
184065900	DHC 758040-5D	75-80	40	400	435	MDC 075080-I/O	WCKX 06T308	P0350903	XT15	MDP 4516	○

☼ Stock item | Produto de stock | Itens de stock ○ Available under request | Disponível sobre consulta | Disponible bajo consulta

Note: This type of drills are supplied without pilot drills. Please order them separately.

Please see Page B - 315 for setting pilot drill.

DHC 8D CARTRIDGE TYPE (SINGLE & DOUBLE INSERT)

Integrex drills | Brocas integrex | Brocas integrex

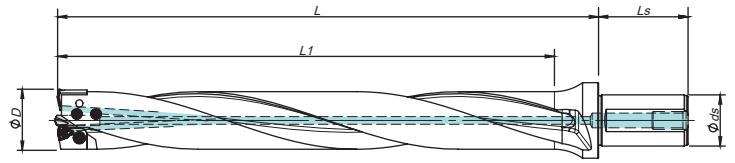

New version / Standard version*

Øds	Ls	BP / SP
40	70 / 80	PT - 1/4

Order code Código	Reference Referência Referencia	Dimensions Dimensões Dimensiones (mm)				Cartridge	Insert	Order separately			Stock
		ØD	Ø ds	L1	L			Insert Screw	Torx key	Pilot drill	
184194400	DHC 004140-8D	41	40	340	375	CWC 041045-I / CWC 000041-O	WCKX 06T308	P0350903	XT15	MDP 3510	○
184194500	DHC 004240-8D	42	40	340	375	CWC 041045-I / CWC 000042-O	WCKX 06T308	P0350903	XT15	MDP 3510	○
184194600	DHC 004340-8D	43	40	340	375	CWC 041045-I / CWC 000043-O	WCKX 06T308	P0350903	XT15	MDP 3510	○
184194700	DHC 004440-8D	44	40	340	375	CWC 041045-I / CWC 000044-O	WCKX 06T308	P0350903	XT15	MDP 3510	○
184194800	DHC 004540-8D	45	40	340	375	CWC 041045-I / CWC 000045-O	WCKX 06T308	P0350903	XT15	MDP 3510	○
184194900	DHC 004640-8D	46	40	380	415	CWC 046050-I / CWC 000046-O	WCKX 06T308	P0350903	XT15	MDP 3510	○
184195000	DHC 004740-8D	47	40	380	415	CWC 046050-I / CWC 000047-O	WCKX 06T308	P0350903	XT15	MDP 3510	○
184195100	DHC 004840-8D	48	40	380	415	CWC 046050-I / CWC 000048-O	WCKX 06T308	P0350903	XT15	MDP 3510	○
184195200	DHC 004940-8D	49	40	380	415	CWC 046050-I / CWC 000049-O	WCKX 06T308	P0350903	XT15	MDP 3510	○
184195300	DHC 005040-8D	50	40	380	415	CWC 046050-I / CWC 000050-O	WCKX 06T308	P0350903	XT15	MDP 3510	○
184195400	DHC 005140-8D	51	40	420	455	CWC 051055-I / CWC 000051-O	WCKX 080408	P0401101	XT15	MDP 3812	○
184195500	DHC 005240-8D	52	40	420	455	CWC 051055-I / CWC 000052-O	WCKX 080408	P0401101	XT15	MDP 3812	○
184195600	DHC 005340-8D	53	40	420	455	CWC 051055-I / CWC 000053-O	WCKX 080408	P0401101	XT15	MDP 3812	○
184195700	DHC 005440-8D	54	40	420	455	CWC 051055-I / CWC 000054-O	WCKX 080408	P0401101	XT15	MDP 3812	○
184195800	DHC 005540-8D	55	40	420	455	CWC 051055-I / CWC 000055-O	WCKX 080408	P0401101	XT15	MDP 3812	○
184195900	DHC 005640-8D	56	40	460	495	CWC 056059-I / CWC 000056-O	WCKX 080408	P0401101	XT15	MDP 3812	○
184196000	DHC 005740-8D	57	40	460	495	CWC 056059-I / CWC 000057-O	WCKX 080408	P0401101	XT15	MDP 3812	○
184196100	DHC 005840-8D	58	40	460	495	CWC 056059-I / CWC 000058-O	WCKX 080408	P0401101	XT15	MDP 3812	○
184196200	DHC 005940-8D	59	40	460	495	CWC 056059-I / CWC 000059-O	WCKX 080408	P0401101	XT15	MDP 3812	○
2 INSERTS PER CARTRIDGE											
184066000	DHC 606540-8D	60-65	40	520	555	MDC 060065-I/O	WCKX 050308	P0300701	XT08	MDP 3812	○
184066100	DHC 657040-8D	65-70	40	560	595	MDC 065070-I/O	WCKX 050308	P0300701	XT08	MDP 3812	○
184066200	DHC 707540-8D	70-75	40	600	635	MDC 070075-I/O	WCKX 050308	P0300701	XT08	MDP 3812	○
184066300	DHC 758040-8D	75-80	40	640	675	MDC 075080-I/O	WCKX 06T308	P0350903	XT15	MDP 4516	○



☺ Stock item | Produto de stock | Itens de stock ○ Available under request | Disponível sobre consulta | Disponible bajo consulta

Note: This type of drills are supplied without pilot drills. Please order them separately.

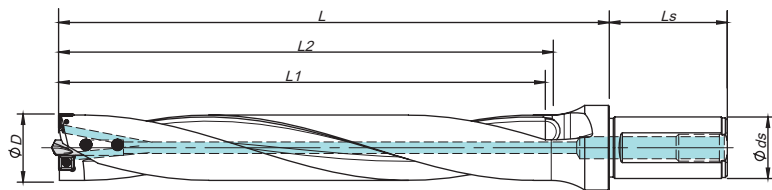
Please see Page B - 315 for setting pilot drill.



Øds	Ls	BP / SP
25	50	PT - 1/8
32	60	PT - 1/4

Order code Código	Reference Referência Referencia	Dimensions Dimensões Dimensiones (mm)					Insert	Insert Screw 	Torx key 	Pilot drill 	Stock
		ØD	Ø ds	L1	L2	L					
		Order separately									
184154300	TFD 18025-6D	18,0	25	108	112	142	SPKX 050204	P0200500	XT06	MDP 2006	○
184154400	TFD 18525-6D	18,5	25	111	115	145	SPKX 050204	P0200500	XT06	MDP 2006	○
184154500	TFD 19025-6D	19,0	25	114	118	148	SPKX 050204	P0200500	XT06	MDP 2006	○
184154600	TFD 19525-6D	19,5	25	117	121	151	SPKX 050204	P0200500	XT06	MDP 2006	○
184154700	TFD 20025-6D	20,0	25	120	124	154	SPKX 060204	P0220500	XT07	MDP 2006	○
184154800	TFD 20525-6D	20,5	25	123	127	157	SPKX 060204	P0220500	XT07	MDP 2006	○
184154900	TFD 21025-6D	21,0	25	126	130	160	SPKX 060204	P0220500	XT07	MDP 2006	○
184155000	TFD 21525-6D	21,5	25	129	133	163	SPKX 060204	P0220500	XT07	MDP 2006	○
184155100	TFD 22025-6D	22,0	25	132	136	166	SPKX 060204	P0220500	XT07	MDP 2006	○
184155200	TFD 22525-6D	22,5	25	135	139	169	SPKX 060204	P0220500	XT07	MDP 2006	○
184155300	TFD 23025-6D	23,0	25	138	142	172	SPKX 060204	P0220500	XT07	MDP 2006	○
184155400	TFD 23525-6D	23,5	25	141	145	175	SPKX 060204	P0220500	XT07	MDP 2006	○
184155500	TFD 24025-6D	24,0	25	144	148	178	SPKX 060204	P0220500	XT07	MDP 2006	○
184155600	TFD 24525-6D	24,5	25	147	151	181	SPKX 060204	P0220500	XT07	MDP 2006	○
184155700	TFD 25025-6D	25,0	25	150	154	184	SPKX 060204	P0220500	XT07	MDP 2006	○
184155800	TFD 25532-6D	25,5	32	153	157	192	SPKX 07T308	P0250704	XT08	MDP 2508	○
184155900	TFD 26032-6D	26,0	32	156	160	195	SPKX 07T308	P0250704	XT08	MDP 2508	○
184156000	TFD 26532-6D	26,5	32	159	163	198	SPKX 07T308	P0250704	XT08	MDP 2508	○
184156100	TFD 27032-6D	27,0	32	162	166	201	SPKX 07T308	P0250704	XT08	MDP 2508	○
184156200	TFD 27532-6D	27,5	32	165	169	204	SPKX 07T308	P0250704	XT08	MDP 2508	○
184156300	TFD 28032-6D	28,0	32	168	172	207	SPKX 07T308	P0250704	XT08	MDP 2508	○
184156400	TFD 28532-6D	28,5	32	171	175	210	SPKX 07T308	P0250704	XT08	MDP 2508	○
184156500	TFD 29032-6D	29,0	32	174	178	213	SPKX 07T308	P0250704	XT08	MDP 2508	○
184156600	TFD 29532-6D	29,5	32	177	181	216	SPKX 07T308	P0250704	XT08	MDP 2508	○
184156700	TFD 30032-6D	30,0	32	180	184	219	SPKX 07T308	P0250704	XT08	MDP 2508	○

Stock item | Produto de stock | Itens de stock Available under request | Disponível sobre consulta | Disponible bajo consulta

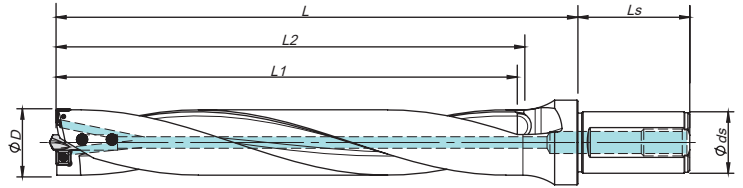

Note: This type of drills are supplied without pilot drills. Please order them separately.

Please see Page B - 315 for setting pilot drill.



Øds	Ls	BP / SP
25	56	PT - 1/8
32	60	PT - 1/4

Order separately

Order code Código	Reference Referência Referencia	Dimensions Dimensões Dimensiones (mm)					Insert	Insert Screw 	Torx key 	Pilot drill 	Stock
		ØD	Ø ds	L1	L2	L					
184151800	TFD 18025-8D	18,0	25	144	149	179	SPKX 050204	P0200500	XT06	MDP 2006	○
184151900	TFD 18525-8D	18,5	25	148	153	183	SPKX 050204	P0200500	XT06	MDP 2006	○
184152000	TFD 19025-8D	19,0	25	152	157	187	SPKX 050204	P0200500	XT06	MDP 2006	○
184152100	TFD 19525-8D	19,5	25	156	161	191	SPKX 050204	P0200500	XT06	MDP 2006	○
184152200	TFD 20025-8D	20,0	25	160	165	195	SPKX 060204	P0220500	XT07	MDP 2006	○
184152300	TFD 20525-8D	20,5	25	164	169	199	SPKX 060204	P0220500	XT07	MDP 2006	○
184152400	TFD 21025-8D	21,0	25	168	173	203	SPKX 060204	P0220500	XT07	MDP 2006	○
184152500	TFD 21525-8D	21,5	25	172	177	207	SPKX 060204	P0220500	XT07	MDP 2006	○
184151200	TFD 22025-8D	22,0	25	176	181	211	SPKX 060204	P0220500	XT07	MDP 2006	○
184152700	TFD 22525-8D	22,5	25	180	185	215	SPKX 060204	P0220500	XT07	MDP 2006	○
184152800	TFD 23025-8D	23,0	25	184	189	219	SPKX 060204	P0220500	XT07	MDP 2006	○
184152900	TFD 23525-8D	23,5	25	188	193	223	SPKX 060204	P0220500	XT07	MDP 2006	○
184153000	TFD 24025-8D	24,0	25	192	197	227	SPKX 060204	P0220500	XT07	MDP 2006	○
184153100	TFD 24525-8D	24,5	25	196	201	231	SPKX 060204	P0220500	XT07	MDP 2006	○
184151300	TFD 25025-8D	25,0	25	200	205	235	SPKX 060204	P0220500	XT07	MDP 2006	○
184153300	TFD 25532-8D	25,5	32	204	209	244	SPKX 07T308	P0250704	XT08	MDP 2508	○
184153400	TFD 26032-8D	26,0	32	208	213	248	SPKX 07T308	P0250704	XT08	MDP 2508	○
184153500	TFD 26532-8D	26,5	32	212	217	252	SPKX 07T308	P0250704	XT08	MDP 2508	○
184153600	TFD 27032-8D	27,0	32	216	221	256	SPKX 07T308	P0250704	XT08	MDP 2508	○
184153700	TFD 27532-8D	27,5	32	220	225	260	SPKX 07T308	P0250704	XT08	MDP 2508	○
184153800	TFD 28032-8D	28,0	32	224	229	264	SPKX 07T308	P0250704	XT08	MDP 2508	○
184153900	TFD 28532-8D	28,5	32	228	233	268	SPKX 07T308	P0250704	XT08	MDP 2508	○
184154000	TFD 29032-8D	29,0	32	232	237	272	SPKX 07T308	P0250704	XT08	MDP 2508	○
184154100	TFD 29532-8D	29,5	32	236	241	276	SPKX 07T308	P0250704	XT08	MDP 2508	○
184154200	TFD 30032-8D	30,0	32	240	245	280	SPKX 07T308	P0250704	XT08	MDP 2508	○

Stock item | Produto de stock | Itens de stock Available under request | Disponível sobre consulta | Disponible bajo consulta

Note: This type of drills are supplied without pilot drills. Please order them separately.

Please see Page B - 315 for setting pilot drill.

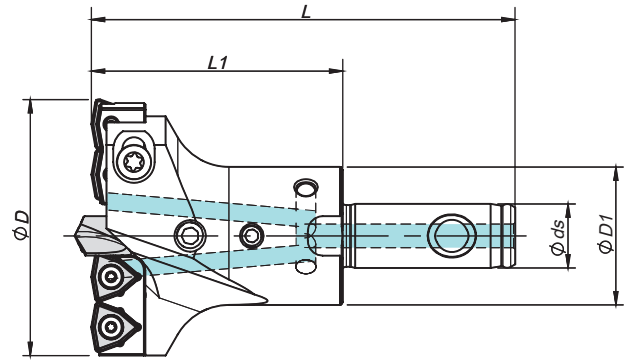
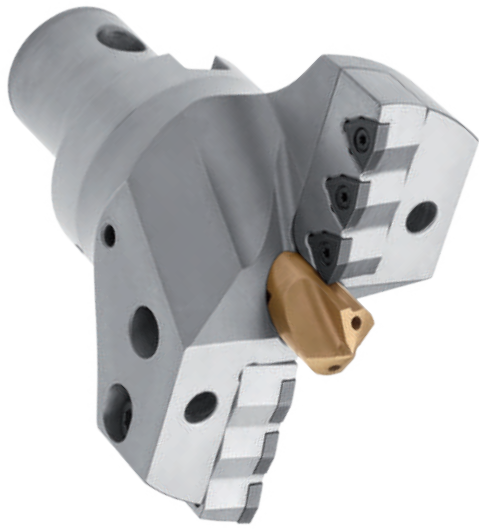

Order separately

Order code Código	Referre Referência Referencia	Dimensions Dimensões Dimensiones (mm)					Cartridge	Insert	Insert Screw	Torx key	Pilot drill	Stock
		ØD	Ø ds	L1	L	ØD1						

2 INSERTS PER CARTRIDGE

184031000	MDO 04505013	45-50	13	50	85	28	MDC 045050-I/O	WCKX 030204	P0220500	XT07	MDP 3510	☉
184031100	MDO 05005513	50-55	13	50	85	28	MDC 050055-I/O	WCKX 030204	P0220500	XT07	MDP 3510	☉
184031200	MDO 05506016	55-60	16	60	100	32	MDC 055060-I/O	WCKX 040204	P0250503	XT08	MDP 3812	☉
184031300	MDO 06006516	60-65	16	60	100	32	MDC 060065-I/O	WCKX 050308	P0300701	XT08	MDP 3812	☉
184031500	MDO 06507016	65-70	16	60	100	32	MDC 065070-I/O	WCKX 050308	P0300701	XT08	MDP 3812	☉
184032400	MDO 07007522	70-75	22	70	115	40	MDC 070075-I/O	WCKX 050308	P0300701	XT08	MDP 3812	☉
184032500	MDO 07508022	75-80	22	70	115	40	MDC 075080-I/O	WCKX 06T308	P0350903	XT15	MDP 4516	☉
184032600	MDO 08008522	80-85	22	70	115	40	MDC 080085-I/O	WCKX 06T308	P0350903	XT15	MDP 4516	☉
184032700	MDO 08509027	85-90	27	70	120	48	MDC 085090-I/O	WCKX 06T308	P0350903	XT15	MDP 4516	☉
184032800	MDO 09009527	90-95	27	70	120	48	MDC 090095-I/O	WCKX 06T308	P0350903	XT15	MDP 4516	☉
184032900	MDO 09510027	95-100	27	70	120	48	MDC 095100-I/O	WCKX 06T308	P0350903	XT15	MDP 4516	☉

3 INSERTS PER CARTRIDGE

184033000	MDO 10010532	100-105	32	80	130	58	MDC 100105-I/O	WCKX 050308	P0300701	XT08	MDP 4520	☉
184066400	MDO 10511032	105-110	32	80	130	58	MDC 105110-I/O	WCKX 06T308	P0350903	XT15	MDP 4520	☉
184066500	MDO 11011532	110-115	32	80	130	58	MDC 110115-I/O	WCKX 06T308	P0350903	XT15	MDP 4520	☉
184066600	MDO 11512040	115-120	40	90	145	70	MDC 115120-I/O	WCKX 06T308	P0350903	XT15	MDP 4520	☉
184066700	MDO 12012540	120-125	40	90	145	70	MDC 120125-I/O	WCKX 06T308	P0350903	XT15	MDP 5625	☉
184066800	MDO 12513040	125-130	40	90	145	70	MDC 125130-I/O	WCKX 06T308	P0350903	XT15	MDP 5625	☉
184066900	MDO 13013540	130-135	40	90	145	70	MDC 130135-I/O	WCKX 06T308	P0350903	XT15	MDP 5625	☉
184067000	MDO 13514040	135-140	40	90	145	70	MDC 135140-I/O	WCKX 06T308	P0350903	XT15	MDP 5625	☉
184067100	MDO 14015050	140-150	50	100	160	80	MDC 140150-I/O	WCKX 080408	P0401101	XT15	MDP 5625	☉
184067200	MDO 15016050	150-160	50	100	160	80	MDC 150160-I/O	WCKX 080408	P0401101	XT15	MDP 5625	☉
184067300	MDO 16017050	160-170	50	100	160	80	MDC 160170-I/O	WCKX 080408	P0401101	XT15	MDP 6830	☉
184067400	MDO 17018050	170-180	50	100	160	80	MDC 170180-I/O	WCKX 080408	P0401101	XT15	MDP 6830	☉

☉ Stock item | Produto de stock | Itens de stock ○ Available under request | Disponível sobre consulta | Disponible bajo consulta

Drills with larger diameter available under request with a minimum order quantity.

Note: This type of drills are supplied without pilot drills. Please order them separately.

Please see Page B - 318 for setting pilot drill.

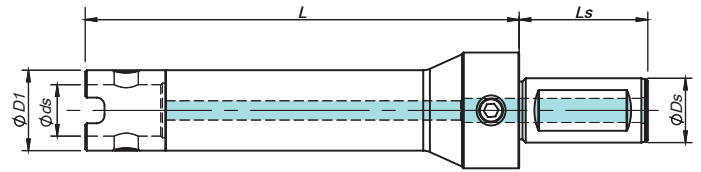

New version / Standard version*

Øds	Ls	BP / SP
32	70	PT - 1/4
40	80	PT - 1/4
50	80 / 100	PT - 1/4

Order separatly

Order code Código	Reference Referência Referencia	Dimensions Dimensões Dimensiones (mm)				 Drive Ring	Stock
		ØDs	Øds	ØD1	L		
184121900	MDS 32115130	32	13	28	115	MDR 1028	⊗
184253700	MDS 32200130	32	13	28	200	MDR 1028	⊗
184255400	MDS 32300130	32	13	28	300	MDR 1028	⊗
184122100	MDS 40125160	40	16	32	125	MDR 1032	⊗
184253800	MDS 40200160	40	16	32	200	MDR 1032	⊗
184255500	MDS 40300160	40	16	32	300	MDR 1032	⊗
184122300	MDS 40148220	40	22	40	148	MDR 1240	⊗
184122400	MDS 40200220	40	22	40	200	MDR 1240	⊗
184122500	MDS 40300220	40	22	40	300	MDR 1240	⊗
184122600	MDS 40168270	40	27	48	168	MDR 1248	⊗
184122700	MDS 40300270	40	27	48	300	MDR 1248	⊗
184122800	MDS 40186320	40	32	58	186	MDR 1458	⊗
184122900	MDS 40300320	40	32	58	300	MDR 1458	⊗
184123000	MDS 50186400	50	40	70	186	MDR 1470	⊗
184123100	MDS 50300400	50	40	70	300	MDR 1470	⊗
184123200	MDS 50184500	50	50	80	184	MDR 1680	⊗
184123300	MDS 50300500	50	50	80	300	MDR 1680	⊗

⊗ Stock item | Produto de stock | Itens de stock ○ Available under request | Disponível sobre consulta | Disponible bajo consulta

Note: This shanks type are supplied without drive ring. Please order them separately.

DRILLING

Jet Drills

Integrex Drills

Vortex Drills

Trepanning Drills

Solid Carbide Drills

Inserts

Spare Parts

Technical Data

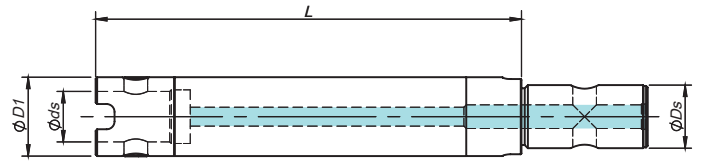

Order separately

Order code Código	Reference Referência Referencia	Dimensions Dimensões Dimensiones (mm)				Drive Ring 	Stock
		ØDs	Øds	ØD1	L		
184023500	MDE 13115280	13	13	28	115	MDR 1028	⊗
184023600	MDE 13150280	13	13	28	150	MDR 1028	⊗
184023700	MDE 13200280	13	13	28	200	MDR 1028	⊗
184021800	MDE 13300280	13	13	28	300	MDR 1028	⊗
184023800	MDE 16115320	16	16	32	115	MDR 1032	⊗
184021900	MDE 16200320	16	16	32	200	MDR 1032	⊗
184023900	MDE 16300320	16	16	32	300	MDR 1032	⊗
184024000	MDE 22113400	22	22	40	113	MDR 1240	⊗
184024100	MDE 22200400	22	22	40	200	MDR 1240	⊗
184024200	MDE 22300400	22	22	40	300	MDR 1240	⊗
184024300	MDE 27113480	27	27	48	113	MDR 1248	⊗
184024400	MDE 27200480	27	27	48	200	MDR 1248	⊗
184024500	MDE 27300480	27	27	48	300	MDR 1248	⊗
184024600	MDE 32186580	32	32	58	186	MDR 1458	⊗
184024700	MDE 32300580	32	32	58	300	MDR 1458	⊗
184024800	MDE 40186700	40	40	70	186	MDR 1470	⊗
184024900	MDE 40300700	40	40	70	300	MDR 1470	⊗
184025000	MDE 40500700	40	40	70	500	MDR 1470	⊗
184025100	MDE 50204800	50	50	80	204	MDR 1680	⊗
184025200	MDE 50300800	50	50	80	300	MDR 1680	⊗
184025300	MDE 50500800	50	50	80	500	MDR 1680	⊗

⊗ Stock item | Produto de stock | Itens de stock ○ Available under request | Disponível sobre consulta | Disponible bajo consulta

Note: This shanks type are supplied without drive ring. Please order them separately.

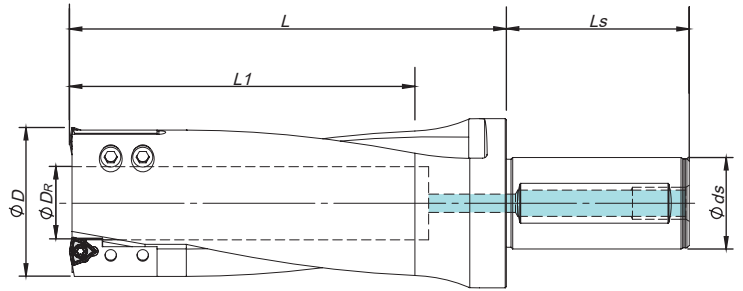

Øds	Ls	BP / SP
32	70	PT - 1/4
40	80	PT - 1/4
50	100	PT - 1/4

Order code Código	Reference Referência Referencia	Dimensions Dimensões Dimensiones (mm)					Cartridge	Insert	Insert Screw	Torx key	Stock
		ØD	Ø DR	Ø ds	L1	L					
184067500	PND 04032-2D	40,0	10,0	32	100	140	PNC 040055-I/O	WCKX 050308	P0300701	XT08	○
184067600	PND 04540-2D	45,0	15,0	40	100	130	PNC 040055-I/O	WCKX 050308	P0300701	XT08	○
184067700	PND 05040-2D	50,0	21,0	40	120	150	PNC 040055-I/O	WCKX 050308	P0300701	XT08	○
184067800	PND 05540-2D	55,0	26,0	40	120	150	PNC 040055-I/O	WCKX 050308	P0300701	XT08	○
184067900	PND 06040-2D	60,0	24,5	40	150	190	PNC 060110-I/O	WCKX 06T308	P0350903	XT15	○
184068000	PND 06540-2D	65,0	30,5	40	150	190	PNC 060110-I/O	WCKX 06T308	P0350903	XT15	○
184068100	PND 07040-2D	70,0	35,5	40	170	210	PNC 060110-I/O	WCKX 06T308	P0350903	XT15	○
184068200	PND 07540-2D	75,0	40,5	40	170	210	PNC 060110-I/O	WCKX 06T308	P0350903	XT15	○
184068300	PND 08040-2D	80,0	45,5	40	190	230	PNC 060110-I/O	WCKX 06T308	P0350903	XT15	○
184068400	PND 08550-2D	85,0	50,5	50	190	230	PNC 060110-I/O	WCKX 06T308	P0350903	XT15	○
184068500	PND 09050-2D	90,0	55,0	50	210	250	PNC 060110-I/O	WCKX 06T308	P0350903	XT15	○
184068600	PND 09550-2D	95,0	60,0	50	210	250	PNC 060110-I/O	WCKX 06T308	P0350903	XT15	○
184068700	PND 10050-2D	100,0	66,0	50	250	290	PNC 060110-I/O	WCKX 06T308	P0350903	XT15	○
184068800	PND 11050-2D	110,0	76,0	50	250	290	PNC 060110-I/O	WCKX 06T308	P0350903	XT15	○

Stock item | Produto de stock | Itens de stock

○ Available under request | Disponível sobre consulta | Disponible bajo consulta

HBDPCE 2 03D

DRILLING

Jet Drills

Integrex Drills

Vortex Drills

Trepanning Drills

Solid Carbide Drills

Inserts

Spare Parts

Technical Data



P	K
HRC ≤ 60	IT8-9 IT class

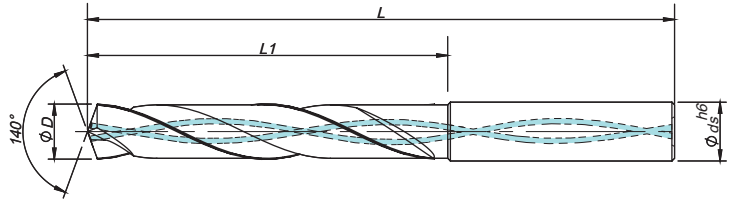

Drill Dia. ØD	ØD3,0	3,0<ØD≤6,0	6,0<ØD≤10,0	10,0<ØD≤18,0	18,0<ØD≤20,0
Hole Tolerances	+0,002	+0,004	+0,006	+0,007	+0,008
	+0,012	+0,016	+0,021	+0,025	+0,028

Order code Código	Reference Referência Referencia	Dimensions Dimensões Dimensiones (mm)				Z	PHU920
		ØD	Ø ds	L1	L		
1180956Z9	HBDPCE 2 03D 0300-062020	3	6	20	62	2	⊗
1180957Z9	HBDPCE 2 03D 0310-062020	3,1	6	20	62	2	⊗
1180958Z9	HBDPCE 2 03D 0320-062020	3,2	6	20	62	2	⊗
1180959Z9	HBDPCE 2 03D 0330-062020	3,3	6	20	62	2	⊗
1180960Z9	HBDPCE 2 03D 0340-062020	3,4	6	20	62	2	⊗
1180961Z9	HBDPCE 2 03D 0350-062020	3,5	6	20	62	2	⊗
1180962Z9	HBDPCE 2 03D 0360-062020	3,6	6	20	62	2	○
1180963Z9	HBDPCE 2 03D 0370-062020	3,7	6	20	62	2	○
1180964Z9	HBDPCE 2 03D 0380-066024	3,8	6	24	66	2	○
1180965Z9	HBDPCE 2 03D 0390-066024	3,9	6	24	66	2	○
1180966Z9	HBDPCE 2 03D 0400-066024	4	6	24	66	2	⊗
1180967Z9	HBDPCE 2 03D 0410-066024	4,1	6	24	66	2	○
1180968Z9	HBDPCE 2 03D 0420-066024	4,2	6	24	66	2	⊗
1180969Z9	HBDPCE 2 03D 0430-066024	4,3	6	24	66	2	○
1180970Z9	HBDPCE 2 03D 0440-066024	4,4	6	24	66	2	○
1180971Z9	HBDPCE 2 03D 0450-066024	4,5	6	24	66	2	○
1180972Z9	HBDPCE 2 03D 0460-066024	4,6	6	24	66	2	⊗
1180973Z9	HBDPCE 2 03D 0470-066024	4,7	6	24	66	2	○
1180974Z9	HBDPCE 2 03D 0480-066028	4,8	6	28	66	2	○
1180975Z9	HBDPCE 2 03D 0490-066028	4,9	6	28	66	2	○
1180976Z9	HBDPCE 2 03D 0500-066028	5	6	28	66	2	⊗
1180977Z9	HBDPCE 2 03D 0510-066028	5,1	6	28	66	2	○

Order code Código	Reference Referência Referencia	Dimensions Dimensões Dimensiones (mm)				Z	PHU920
		ØD	Ø ds	L1	L		
1180978Z9	HBDPCE 2 03D 0520-066028	5,2	6	28	66	2	○
1180979Z9	HBDPCE 2 03D 0530-066028	5,3	6	28	66	2	○
1180980Z9	HBDPCE 2 03D 0540-066028	5,4	6	28	66	2	○
1180981Z9	HBDPCE 2 03D 0550-066028	5,5	6	28	66	2	○
1180982Z9	HBDPCE 2 03D 0560-066028	5,6	6	28	66	2	⊗
1180983Z9	HBDPCE 2 03D 0570-066028	5,7	6	28	66	2	○
1180984Z9	HBDPCE 2 03D 0580-066028	5,8	6	28	66	2	○
1180985Z9	HBDPCE 2 03D 0590-066028	5,9	6	28	66	2	○
1180986Z9	HBDPCE 2 03D 0600-066028	6	6	28	66	2	⊗
1180987Z9	HBDPCE 2 03D 0610-079034	6,1	8	34	79	2	○
1180988Z9	HBDPCE 2 03D 0620-079034	6,2	8	34	79	2	○
1180989Z9	HBDPCE 2 03D 0630-079034	6,3	8	34	79	2	○
1180990Z9	HBDPCE 2 03D 0640-079034	6,4	8	34	79	2	○
1180991Z9	HBDPCE 2 03D 0650-079034	6,5	8	34	79	2	⊗
1180792Z9	HBDPCE 2 03D 0660-079034	6,6	8	34	79	2	○
1180992Z9	HBDPCE 2 03D 0670-079034	6,7	8	34	79	2	○
1180993Z9	HBDPCE 2 03D 0680-079034	6,8	8	34	79	2	⊗
1180994Z9	HBDPCE 2 03D 0690-079034	6,9	8	34	79	2	○
1180995Z9	HBDPCE 2 03D 0700-079034	7	8	34	79	2	⊗
1180996Z9	HBDPCE 2 03D 0710-079041	7,1	8	41	79	2	○
1180997Z9	HBDPCE 2 03D 0720-079041	7,2	8	41	79	2	○
1180998Z9	HBDPCE 2 03D 0730-079041	7,3	8	41	79	2	○

⊗ Stock item | Produto de stock
Itens de stock

○ Available under request | Disponível sobre consulta
Disponível bajo consulta

Order code Código	Reference Referência Referencia	Dimensions Dimensões Dimensiones (mm)				Z	PHU920
		ØD	Ø ds	L1	L		
1180999Z9	HBDPCE 2 03D 0740-079041	7,4	8	41	79	2	○
1181000Z9	HBDPCE 2 03D 0750-079041	7,5	8	41	79	2	○
1181001Z9	HBDPCE 2 03D 0760-079041	7,6	8	41	79	2	○
1181002Z9	HBDPCE 2 03D 0770-079041	7,7	8	41	79	2	○
1181003Z9	HBDPCE 2 03D 0780-079041	7,8	8	41	79	2	○
1181004Z9	HBDPCE 2 03D 0790-079041	7,9	8	41	79	2	○
1181005Z9	HBDPCE 2 03D 0800-079041	8	8	41	79	2	⊗
1181006Z9	HBDPCE 2 03D 0810-089047	8,1	10	47	89	2	○
1181007Z9	HBDPCE 2 03D 0820-089047	8,2	10	47	89	2	○
1181008Z9	HBDPCE 2 03D 0830-089047	8,3	10	47	89	2	○
1181009Z9	HBDPCE 2 03D 0840-089047	8,4	10	47	89	2	○
1181010Z9	HBDPCE 2 03D 0850-089047	8,5	10	47	89	2	○
1181011Z9	HBDPCE 2 03D 0860-089047	8,6	10	47	89	2	○
1181012Z9	HBDPCE 2 03D 0870-089047	8,7	10	47	89	2	○
1181013Z9	HBDPCE 2 03D 0880-089047	8,8	10	47	89	2	○
1181014Z9	HBDPCE 2 03D 0890-089047	8,9	10	47	89	2	○
1181015Z9	HBDPCE 2 03D 0900-089047	9	10	47	89	2	⊗
1181016Z9	HBDPCE 2 03D 0910-089047	9,1	10	47	89	2	○
1181017Z9	HBDPCE 2 03D 0920-089047	9,2	10	47	89	2	○
1181018Z9	HBDPCE 2 03D 0930-089047	9,3	10	47	89	2	○
1181019Z9	HBDPCE 2 03D 0940-089047	9,4	10	47	89	2	○
1181020Z9	HBDPCE 2 03D 0950-089047	9,5	10	47	89	2	○
1181021Z9	HBDPCE 2 03D 0960-089047	9,6	10	47	89	2	○
1181022Z9	HBDPCE 2 03D 0970-089047	9,7	10	47	89	2	○
1181023Z9	HBDPCE 2 03D 0980-089047	9,8	10	47	89	2	○
1181024Z9	HBDPCE 2 03D 0990-089047	9,9	10	47	89	2	○
1181025Z9	HBDPCE 2 03D 1000-089047	10	10	47	89	2	⊗
1181026Z9	HBDPCE 2 03D 1010-102055	10,1	12	55	102	2	○
1181027Z9	HBDPCE 2 03D 1020-102055	10,2	12	55	102	2	⊗
1181028Z9	HBDPCE 2 03D 1030-102055	10,3	12	55	102	2	○
1181029Z9	HBDPCE 2 03D 1040-102055	10,4	12	55	102	2	○
1181030Z9	HBDPCE 2 03D 1050-102055	10,5	12	55	102	2	○
1181031Z9	HBDPCE 2 03D 1060-102055	10,6	12	55	102	2	○
1181032Z9	HBDPCE 2 03D 1070-102055	10,7	12	55	102	2	○
1181033Z9	HBDPCE 2 03D 1080-102055	10,8	12	55	102	2	○
1181034Z9	HBDPCE 2 03D 1090-102055	10,9	12	55	102	2	○
1181035Z9	HBDPCE 2 03D 1100-102055	11	12	55	102	2	⊗
1181036Z9	HBDPCE 2 03D 1110-102055	11,1	12	55	102	2	○
1181037Z9	HBDPCE 2 03D 1120-102055	11,2	12	55	102	2	○
1181038Z9	HBDPCE 2 03D 1130-102055	11,3	12	55	102	2	○
1181039Z9	HBDPCE 2 03D 1140-102055	11,4	12	55	102	2	○
1181040Z9	HBDPCE 2 03D 1150-102055	11,5	12	55	102	2	○
1181041Z9	HBDPCE 2 03D 1160-102055	11,6	12	55	102	2	○
1181042Z9	HBDPCE 2 03D 1170-102055	11,7	12	55	102	2	○
1181043Z9	HBDPCE 2 03D 1180-102055	11,8	12	55	102	2	○

Order code Código	Reference Referência Referencia	Dimensions Dimensões Dimensiones (mm)				Z	PHU920
		ØD	Ø ds	L1	L		
1181044Z9	HBDPCE 2 03D 1190-102055	11,9	12	55	102	2	○
1181045Z9	HBDPCE 2 03D 1200-102055	12	12	55	102	2	⊗
1181046Z9	HBDPCE 2 03D 1250-107060	12,5	14	60	107	2	⊗
1181047Z9	HBDPCE 2 03D 1300-107060	13	14	60	107	2	○
1181048Z9	HBDPCE 2 03D 1350-107060	13,5	14	60	107	2	○
1181049Z9	HBDPCE 2 03D 1400-107060	14	14	60	107	2	⊗
1181050Z9	HBDPCE 2 03D 1450-115065	14,5	16	65	115	2	⊗
1181051Z9	HBDPCE 2 03D 1500-115065	15	16	65	115	2	⊗
1181052Z9	HBDPCE 2 03D 1550-115065	15,5	16	65	115	2	○
1181053Z9	HBDPCE 2 03D 1600-115065	16	16	65	115	2	○
1181054Z9	HBDPCE 2 03D 1650-123073	16,5	18	73	123	2	○
1181055Z9	HBDPCE 2 03D 1700-123073	17	18	73	123	2	○
1181056Z9	HBDPCE 2 03D 1750-123073	17,5	18	73	123	2	○
1181057Z9	HBDPCE 2 03D 1800-123073	18	18	73	123	2	○
1181058Z9	HBDPCE 2 03D 1850-131079	18,5	20	79	131	2	○
1181059Z9	HBDPCE 2 03D 1900-131079	19	20	79	131	2	○
1181060Z9	HBDPCE 2 03D 1950-131079	19,5	20	79	131	2	○
1181061Z9	HBDPCE 2 03D 2000-131079	20	20	79	131	2	○

⊗ Stock item | Produto de stock
Itens de stock

○ Available under request | Disponível sobre consulta
Disponível bajo consulta

HBDPUE 2 03D

DRILLING

Jet Drills

Integrex Drills

Vortex Drills

Trepanning Drills

Solid Carbide Drills

Inserts

Spare Parts

Technical Data



P	K
HRC ≤ 60	IT8-9 IT class

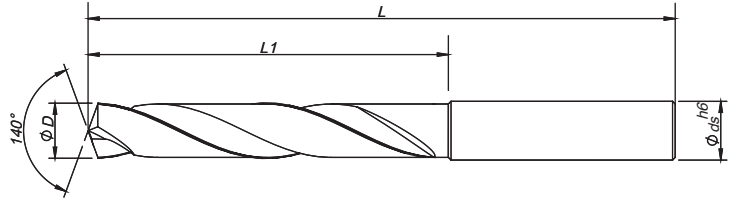

Drill Dia. ØD	ØD3,0	3,0<ØD≤6,0	6,0<ØD≤10,0	10,0<ØD≤18,0	18,0<ØD≤20,0
Hole Tolerances	+0,002	+0,004	+0,006	+0,007	+0,008
	+0,012	+0,016	+0,021	+0,025	+0,028

Order code Código	Reference Referência Referencia	Dimensions Dimensões Dimensiones (mm)				Z	PHU920
		ØD	Ø ds	L1	L		
1180784Z9	HBDPUE 2 03D 0300-062020	3	6	20	62	2	○
1180852Z9	HBDPUE 2 03D 0310-062020	3,1	6	20	62	2	○
1180853Z9	HBDPUE 2 03D 0320-062020	3,2	6	20	62	2	○
1180854Z9	HBDPUE 2 03D 0330-062020	3,3	6	20	62	2	○
1180790Z9	HBDPUE 2 03D 0340-062020	3,4	6	20	62	2	○
1180855Z9	HBDPUE 2 03D 0350-062020	3,5	6	20	62	2	○
1180856Z9	HBDPUE 2 03D 0360-062020	3,6	6	20	62	2	○
1180857Z9	HBDPUE 2 03D 0370-062020	3,7	6	20	62	2	○
1180858Z9	HBDPUE 2 03D 0380-066024	3,8	6	24	66	2	○
1180859Z9	HBDPUE 2 03D 0390-066024	3,9	6	24	66	2	○
1180860Z9	HBDPUE 2 03D 0400-066024	4	6	24	66	2	○
1180861Z9	HBDPUE 2 03D 0410-066024	4,1	6	24	66	2	○
1180862Z9	HBDPUE 2 03D 0420-066024	4,2	6	24	66	2	○
1180863Z9	HBDPUE 2 03D 0430-066024	4,3	6	24	66	2	○
1180864Z9	HBDPUE 2 03D 0440-066024	4,4	6	24	66	2	○
1180865Z9	HBDPUE 2 03D 0450-066024	4,5	6	24	66	2	○
1180866Z9	HBDPUE 2 03D 0460-066024	4,6	6	24	66	2	○
1180867Z9	HBDPUE 2 03D 0470-066024	4,7	6	24	66	2	○
1180868Z9	HBDPUE 2 03D 0480-066028	4,8	6	28	66	2	○
1180869Z9	HBDPUE 2 03D 0490-066028	4,9	6	28	66	2	○
1180870Z9	HBDPUE 2 03D 0500-066028	5	6	28	66	2	○
1180871Z9	HBDPUE 2 03D 0510-066028	5,1	6	28	66	2	○

Order code Código	Reference Referência Referencia	Dimensions Dimensões Dimensiones (mm)				Z	PHU920
		ØD	Ø ds	L1	L		
1180872Z9	HBDPUE 2 03D 0520-066028	5,2	6	28	66	2	○
1180873Z9	HBDPUE 2 03D 0530-066028	5,3	6	28	66	2	○
1180874Z9	HBDPUE 2 03D 0540-066028	5,4	6	28	66	2	○
1180875Z9	HBDPUE 2 03D 0550-066028	5,5	6	28	66	2	○
1180791Z9	HBDPUE 2 03D 0560-066028	5,6	6	28	66	2	○
1180876Z9	HBDPUE 2 03D 0570-066028	5,7	6	28	66	2	○
1180877Z9	HBDPUE 2 03D 0580-066028	5,8	6	28	66	2	○
1180878Z9	HBDPUE 2 03D 0590-066028	5,9	6	28	66	2	○
1180879Z9	HBDPUE 2 03D 0600-066028	6	6	28	66	2	○
1180880Z9	HBDPUE 2 03D 0610-079034	6,1	8	34	79	2	○
1180881Z9	HBDPUE 2 03D 0620-079034	6,2	8	34	79	2	○
1180882Z9	HBDPUE 2 03D 0630-079034	6,3	8	34	79	2	○
1180883Z9	HBDPUE 2 03D 0640-079034	6,4	8	34	79	2	○
1180884Z9	HBDPUE 2 03D 0650-079034	6,5	8	34	79	2	○
1180885Z9	HBDPUE 2 03D 0660-079034	6,6	8	34	79	2	○
1180886Z9	HBDPUE 2 03D 0670-079034	6,7	8	34	79	2	○
1180887Z9	HBDPUE 2 03D 0680-079034	6,8	8	34	79	2	○
1180888Z9	HBDPUE 2 03D 0690-079034	6,9	8	34	79	2	○
1180889Z9	HBDPUE 2 03D 0700-079034	7	8	34	79	2	○
1180890Z9	HBDPUE 2 03D 0710-079041	7,1	8	41	79	2	○
1180891Z9	HBDPUE 2 03D 0720-079041	7,2	8	41	79	2	○
1180892Z9	HBDPUE 2 03D 0730-079041	7,3	8	41	79	2	○

Stock item | Produto de stock / Available under request | Disponível sobre consulta / Disponible bajo consulta

Order code Código	Reference Referência Referencia	Dimensions Dimensões Dimensiones (mm)				Z	PHU920
		ØD	Ø ds	L1	L		
1180893Z9	HBDPUE 2 03D 0740-079041	7,4	8	41	79	2	○
1180894Z9	HBDPUE 2 03D 0750-079041	7,5	8	41	79	2	○
1180895Z9	HBDPUE 2 03D 0760-079041	7,6	8	41	79	2	○
1180896Z9	HBDPUE 2 03D 0770-079041	7,7	8	41	79	2	○
1180897Z9	HBDPUE 2 03D 0780-079041	7,8	8	41	79	2	○
1180898Z9	HBDPUE 2 03D 0790-079041	7,9	8	41	79	2	○
1180899Z9	HBDPUE 2 03D 0800-079041	8	8	41	79	2	○
1180900Z9	HBDPUE 2 03D 0810-089047	8,1	10	47	89	2	○
1180901Z9	HBDPUE 2 03D 0820-089047	8,2	10	47	89	2	○
1180902Z9	HBDPUE 2 03D 0830-089047	8,3	10	47	89	2	○
1180903Z9	HBDPUE 2 03D 0840-089047	8,4	10	47	89	2	○
1180904Z9	HBDPUE 2 03D 0850-089047	8,5	10	47	89	2	○
1180905Z9	HBDPUE 2 03D 0860-089047	8,6	10	47	89	2	○
1180906Z9	HBDPUE 2 03D 0870-089047	8,7	10	47	89	2	○
1180907Z9	HBDPUE 2 03D 0880-089047	8,8	10	47	89	2	○
1180908Z9	HBDPUE 2 03D 0890-089047	8,9	10	47	89	2	○
1180909Z9	HBDPUE 2 03D 0900-089047	9	10	47	89	2	○
1180910Z9	HBDPUE 2 03D 0910-089047	9,1	10	47	89	2	○
1180911Z9	HBDPUE 2 03D 0920-089047	9,2	10	47	89	2	○
1180912Z9	HBDPUE 2 03D 0930-089047	9,3	10	47	89	2	○
1180913Z9	HBDPUE 2 03D 0940-089047	9,4	10	47	89	2	○
1180914Z9	HBDPUE 2 03D 0950-089047	9,5	10	47	89	2	○
1180915Z9	HBDPUE 2 03D 0960-089047	9,6	10	47	89	2	○
1180916Z9	HBDPUE 2 03D 0970-089047	9,7	10	47	89	2	○
1180917Z9	HBDPUE 2 03D 0980-089047	9,8	10	47	89	2	○
1180918Z9	HBDPUE 2 03D 0990-089047	9,9	10	47	89	2	○
1180919Z9	HBDPUE 2 03D 1000-089047	10	10	47	89	2	○
1180920Z9	HBDPUE 2 03D 1010-102055	10,1	12	55	102	2	○
1180921Z9	HBDPUE 2 03D 1020-102055	10,2	12	55	102	2	○
1180922Z9	HBDPUE 2 03D 1030-102055	10,3	12	55	102	2	○
1180923Z9	HBDPUE 2 03D 1040-102055	10,4	12	55	102	2	○
1180924Z9	HBDPUE 2 03D 1050-102055	10,5	12	55	102	2	○
1180925Z9	HBDPUE 2 03D 1060-102055	10,6	12	55	102	2	○
1180926Z9	HBDPUE 2 03D 1070-102055	10,7	12	55	102	2	○
1180927Z9	HBDPUE 2 03D 1080-102055	10,8	12	55	102	2	○
1180928Z9	HBDPUE 2 03D 1090-102055	10,9	12	55	102	2	○
1180929Z9	HBDPUE 2 03D 1100-102055	11	12	55	102	2	○
1180930Z9	HBDPUE 2 03D 1110-102055	11,1	12	55	102	2	○
1180931Z9	HBDPUE 2 03D 1120-102055	11,2	12	55	102	2	○
1180932Z9	HBDPUE 2 03D 1130-102055	11,3	12	55	102	2	○
1180933Z9	HBDPUE 2 03D 1140-102055	11,4	12	55	102	2	○
1180934Z9	HBDPUE 2 03D 1150-102055	11,5	12	55	102	2	○
1180935Z9	HBDPUE 2 03D 1160-102055	11,6	12	55	102	2	○
1180936Z9	HBDPUE 2 03D 1170-102055	11,7	12	55	102	2	○
1180937Z9	HBDPUE 2 03D 1180-102055	11,8	12	55	102	2	○

Order code Código	Reference Referência Referencia	Dimensions Dimensões Dimensiones (mm)				Z	PHU920
		ØD	Ø ds	L1	L		
1180938Z9	HBDPUE 2 03D 1190-102055	11,9	12	55	102	2	○
1180939Z9	HBDPUE 2 03D 1200-102055	12	12	55	102	2	○
1180940Z9	HBDPUE 2 03D 1250-107060	12,5	14	60	107	2	○
1180941Z9	HBDPUE 2 03D 1300-107060	13	14	60	107	2	○
1180942Z9	HBDPUE 2 03D 1350-107060	13,5	14	60	107	2	○
1180943Z9	HBDPUE 2 03D 1400-107060	14	14	60	107	2	○
1180944Z9	HBDPUE 2 03D 1450-115065	14,5	16	65	115	2	○
1180945Z9	HBDPUE 2 03D 1500-115065	15	16	65	115	2	○
1180946Z9	HBDPUE 2 03D 1550-115065	15,5	16	65	115	2	○
1180947Z9	HBDPUE 2 03D 1600-115065	16	16	65	115	2	○
1180948Z9	HBDPUE 2 03D 1650-123073	16,5	18	73	123	2	○
1180949Z9	HBDPUE 2 03D 1700-123073	17	18	73	123	2	○
1180950Z9	HBDPUE 2 03D 1750-123073	17,5	18	73	123	2	○
1180951Z9	HBDPUE 2 03D 1800-123073	18	18	73	123	2	○
1180952Z9	HBDPUE 2 03D 1850-131079	18,5	20	79	131	2	○
1180953Z9	HBDPUE 2 03D 1900-131079	19	20	79	131	2	○
1180954Z9	HBDPUE 2 03D 1950-131079	19,5	20	79	131	2	○
1180955Z9	HBDPUE 2 03D 2000-131079	20	20	79	131	2	○

Stock item | Produto de stock
Itens de stock

Available under request | Disponível sobre consulta
Disponível bajo consulta

HBDPCE 2 05D

DRILLING

Jet Drills

Integrex Drills

Vortex Drills

Trepanning Drills

Solid Carbide Drills

Inserts

Spare Parts

Technical Data

P K

HRC ≤ 60

IT8-9 IT class

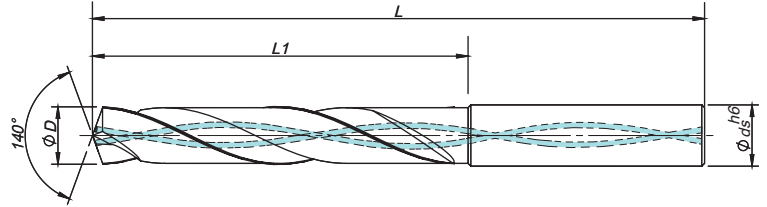

Drill Dia. ØD	ØD3,0	3,0<ØD≤6,0	6,0<ØD≤10,0	10,0<ØD≤18,0	18,0<ØD≤20,0
Hole Tolerances	+0,002	+0,004	+0,006	+0,007	+0,008
	+0,012	+0,016	+0,021	+0,025	+0,028

Order code Código	Reference Referência Referencia	Dimensions Dimensões Dimensiones (mm)				Z	PHU920
		ØD	Ø ds	L1	L		
1180788Z9	HBDPCE 2 05D 0300-066028	3	6	28	66	2	⊗
1181160Z9	HBDPCE 2 05D 0310-066028	3,1	6	28	66	2	⊗
1181161Z9	HBDPCE 2 05D 0320-066028	3,2	6	28	66	2	⊗
1181162Z9	HBDPCE 2 05D 0330-066028	3,3	6	28	66	2	⊗
1180797Z9	HBDPCE 2 05D 0340-066028	3,4	6	28	66	2	⊗
1181163Z9	HBDPCE 2 05D 0350-066028	3,5	6	28	66	2	⊗
1181164Z9	HBDPCE 2 05D 0360-066028	3,6	6	28	66	2	○
1180798Z9	HBDPCE 2 05D 0370-066028	3,7	6	28	66	2	⊗
1181165Z9	HBDPCE 2 05D 0380-074036	3,8	6	36	74	2	○
1181166Z9	HBDPCE 2 05D 0390-074036	3,9	6	36	74	2	○
1181167Z9	HBDPCE 2 05D 0400-074036	4	6	36	74	2	⊗
1181168Z9	HBDPCE 2 05D 0410-074036	4,1	6	36	74	2	⊗
1180799Z9	HBDPCE 2 05D 0420-074036	4,2	6	36	74	2	⊗
1180800Z9	HBDPCE 2 05D 0430-074036	4,3	6	36	74	2	⊗
1181169Z9	HBDPCE 2 05D 0440-074036	4,4	6	36	74	2	○
1181170Z9	HBDPCE 2 05D 0450-074036	4,5	6	36	74	2	○
1181171Z9	HBDPCE 2 05D 0460-074036	4,6	6	36	74	2	○
1181172Z9	HBDPCE 2 05D 0470-074036	4,7	6	36	74	2	⊗
1181173Z9	HBDPCE 2 05D 0480-082044	4,8	6	44	82	2	○
1181174Z9	HBDPCE 2 05D 0490-082044	4,9	6	44	82	2	○
1180801Z9	HBDPCE 2 05D 0500-082044	5	6	44	82	2	⊗
1181175Z9	HBDPCE 2 05D 0510-082044	5,1	6	44	82	2	○
1181176Z9	HBDPCE 2 05D 0520-082044	5,2	6	44	82	2	○
1181177Z9	HBDPCE 2 05D 0530-082044	5,3	6	44	82	2	○
1181178Z9	HBDPCE 2 05D 0540-082044	5,4	6	44	82	2	○

Order code Código	Reference Referência Referencia	Dimensions Dimensões Dimensiones (mm)				Z	PHU920
		ØD	Ø ds	L1	L		
1181179Z9	HBDPCE 2 05D 0550-082044	5,5	6	44	82	2	○
1181180Z9	HBDPCE 2 05D 0560-082044	5,6	6	44	82	2	○
1181181Z9	HBDPCE 2 05D 0570-082044	5,7	6	44	82	2	○
1180802Z9	HBDPCE 2 05D 0580-082044	5,8	6	44	82	2	⊗
1181182Z9	HBDPCE 2 05D 0590-082044	5,9	6	44	82	2	○
1181183Z9	HBDPCE 2 05D 0600-082044	6	6	44	82	2	⊗
1181184Z9	HBDPCE 2 05D 0610-091053	6,1	8	53	91	2	○
1181185Z9	HBDPCE 2 05D 0620-091053	6,2	8	53	91	2	○
1181186Z9	HBDPCE 2 05D 0630-091053	6,3	8	53	91	2	○
1181187Z9	HBDPCE 2 05D 0640-091053	6,4	8	53	91	2	○
1180787Z9	HBDPCE 2 05D 0650-091053	6,5	8	53	91	2	⊗
1181188Z9	HBDPCE 2 05D 0660-091053	6,6	8	53	91	2	⊗
1181189Z9	HBDPCE 2 05D 0670-091053	6,7	8	53	91	2	○
1180803Z9	HBDPCE 2 05D 0680-091053	6,8	8	53	91	2	⊗
1181190Z9	HBDPCE 2 05D 0690-091053	6,9	8	53	91	2	○
1180804Z9	HBDPCE 2 05D 0700-091053	7	8	53	91	2	⊗
1181191Z9	HBDPCE 2 05D 0710-091053	7,1	8	53	91	2	○
1181192Z9	HBDPCE 2 05D 0720-091053	7,2	8	53	91	2	○
1181193Z9	HBDPCE 2 05D 0730-091053	7,3	8	53	91	2	○
1180805Z9	HBDPCE 2 05D 0740-091053	7,4	8	53	91	2	⊗
1181194Z9	HBDPCE 2 05D 0750-091053	7,5	8	53	91	2	○
1181195Z9	HBDPCE 2 05D 0760-091053	7,6	8	53	91	2	○
1181196Z9	HBDPCE 2 05D 0770-091053	7,7	8	53	91	2	○
1181197Z9	HBDPCE 2 05D 0780-091053	7,8	8	53	91	2	○
1181198Z9	HBDPCE 2 05D 0790-091053	7,9	8	53	91	2	○

⊗ Stock item | Produto de stock
Itens de stock

○ Available under request | Disponível sobre consulta
Disponível bajo consulta

Order code Código	Reference Referência Referencia	Dimensions Dimensões Dimensiones (mm)				Z	PHU920
		ØD	Ø ds	L1	L		
1181199Z9	HBDPCE 2 05D 0800-091053	8	8	53	91	2	⊗
1181200Z9	HBDPCE 2 05D 0810-103061	8,1	10	61	103	2	○
1181201Z9	HBDPCE 2 05D 0820-103061	8,2	10	61	103	2	○
1181202Z9	HBDPCE 2 05D 0830-103061	8,3	10	61	103	2	○
1181203Z9	HBDPCE 2 05D 0840-103061	8,4	10	61	103	2	○
1180806Z9	HBDPCE 2 05D 0850-103061	8,5	10	61	103	2	⊗
1181204Z9	HBDPCE 2 05D 0860-103061	8,6	10	61	103	2	○
1181205Z9	HBDPCE 2 05D 0870-103061	8,7	10	61	103	2	○
1181206Z9	HBDPCE 2 05D 0880-103061	8,8	10	61	103	2	○
1181207Z9	HBDPCE 2 05D 0890-103061	8,9	10	61	103	2	○
1180807Z9	HBDPCE 2 05D 0900-103061	9	10	61	103	2	⊗
1181208Z9	HBDPCE 2 05D 0910-103061	9,1	10	61	103	2	○
1181209Z9	HBDPCE 2 05D 0920-103061	9,2	10	61	103	2	○
1181210Z9	HBDPCE 2 05D 0930-103061	9,3	10	61	103	2	○
1181211Z9	HBDPCE 2 05D 0940-103061	9,4	10	61	103	2	○
1181212Z9	HBDPCE 2 05D 0950-103061	9,5	10	61	103	2	○
1181213Z9	HBDPCE 2 05D 0960-103061	9,6	10	61	103	2	○
1181214Z9	HBDPCE 2 05D 0970-103061	9,7	10	61	103	2	○
1181215Z9	HBDPCE 2 05D 0980-103061	9,8	10	61	103	2	○
1181216Z9	HBDPCE 2 05D 0990-103061	9,9	10	61	103	2	○
1181217Z9	HBDPCE 2 05D 1000-103061	10	10	61	103	2	⊗
1181218Z9	HBDPCE 2 05D 1010-118071	10,1	12	71	118	2	○
1180808Z9	HBDPCE 2 05D 1020-118071	10,2	12	71	118	2	⊗
1181219Z9	HBDPCE 2 05D 1030-118071	10,3	12	71	118	2	○
1181220Z9	HBDPCE 2 05D 1040-118071	10,4	12	71	118	2	○
1180809Z9	HBDPCE 2 05D 1050-118071	10,5	12	71	118	2	⊗
1180810Z9	HBDPCE 2 05D 1060-118071	10,6	12	71	118	2	⊗
1181221Z9	HBDPCE 2 05D 1070-118071	10,7	12	71	118	2	○
1181222Z9	HBDPCE 2 05D 1080-118071	10,8	12	71	118	2	○
1181223Z9	HBDPCE 2 05D 1090-118071	10,9	12	71	118	2	○
1180811Z9	HBDPCE 2 05D 1100-118071	11	12	71	118	2	⊗
1181224Z9	HBDPCE 2 05D 1110-118071	11,1	12	71	118	2	○
1181225Z9	HBDPCE 2 05D 1120-118071	11,2	12	71	118	2	○
1181226Z9	HBDPCE 2 05D 1130-118071	11,3	12	71	118	2	○
1181227Z9	HBDPCE 2 05D 1140-118071	11,4	12	71	118	2	○
1180812Z9	HBDPCE 2 05D 1150-118071	11,5	12	71	118	2	⊗
1181228Z9	HBDPCE 2 05D 1160-118071	11,6	12	71	118	2	○
1181229Z9	HBDPCE 2 05D 1170-118071	11,7	12	71	118	2	○
1181230Z9	HBDPCE 2 05D 1180-118071	11,8	12	71	118	2	○
1181231Z9	HBDPCE 2 05D 1190-118071	11,9	12	71	118	2	○
1180813Z9	HBDPCE 2 05D 1200-118071	12	12	71	118	2	⊗
1181232Z9	HBDPCE 2 05D 1250-124077	12,5	14	77	124	2	○
1180814Z9	HBDPCE 2 05D 1300-124077	13	14	77	124	2	⊗
1181233Z9	HBDPCE 2 05D 1350-124077	13,5	14	77	124	2	○
1181234Z9	HBDPCE 2 05D 1400-124077	14	14	77	124	2	○

Order code Código	Reference Referência Referencia	Dimensions Dimensões Dimensiones (mm)				Z	PHU920
		ØD	Ø ds	L1	L		
1181235Z9	HBDPCE 2 05D 1450-133083	14,5	16	83	133	2	○
1181236Z9	HBDPCE 2 05D 1500-133083	15	16	83	133	2	○
1181237Z9	HBDPCE 2 05D 1550-133083	15,5	16	83	133	2	○
1181238Z9	HBDPCE 2 05D 1600-133083	16	16	83	133	2	○
1181239Z9	HBDPCE 2 05D 1650-143093	16,5	18	93	143	2	○
1181240Z9	HBDPCE 2 05D 1700-143093	17	18	93	143	2	○
1180816Z9	HBDPCE 2 05D 1750-143093	17,5	18	93	143	2	⊗
1181241Z9	HBDPCE 2 05D 1800-143093	18	18	93	143	2	○
1181242Z9	HBDPCE 2 05D 1850-153101	18,5	20	101	153	2	○
1181243Z9	HBDPCE 2 05D 1900-153101	19	20	101	153	2	○
1181244Z9	HBDPCE 2 05D 1950-153101	19,5	20	101	153	2	○
1181245Z9	HBDPCE 2 05D 2000-153101	20	20	101	153	2	○

⊗ Stock item | Produto de stock
Itens de stock

○ Available under request | Disponível sobre consulta
Disponível bajo consulta

HBDPUE 2 05D

DRILLING

Jet Drills

Integrex Drills

Vortex Drills

Trepanning Drills

Solid Carbide Drills

Inserts

Spare Parts

Technical Data

P K

HRC ≤ 60
IT8-9 IT class

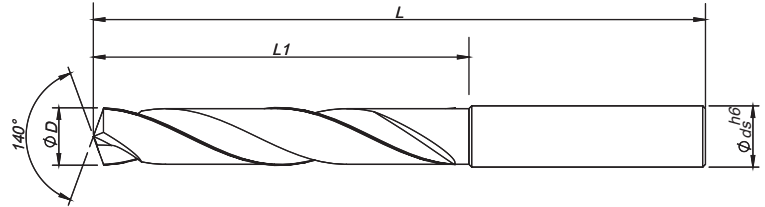

Drill Dia. ØD	ØD3,0	3,0<ØD≤6,0	6,0<ØD≤10,0	10,0<ØD≤18,0	18,0<ØD≤20,0
Hole Tolerances	+0,002	+0,004	+0,006	+0,007	+0,008
	+0,012	+0,016	+0,021	+0,025	+0,028

Order code Código	Reference Referência Referencia	Dimensions Dimensões Dimensiones (mm)				Z	PHU920
		ØD	Ø ds	L1	L		
1180793Z9	HBDPUE 2 05D 0300-066028	3	6	28	66	2	○
1180794Z9	HBDPUE 2 05D 0310-066028	3,1	6	28	66	2	○
1181062Z9	HBDPUE 2 05D 0320-066028	3,2	6	28	66	2	○
1181063Z9	HBDPUE 2 05D 0330-066028	3,3	6	28	66	2	○
1180789Z9	HBDPUE 2 05D 0340-066028	3,4	6	28	66	2	○
1181064Z9	HBDPUE 2 05D 0350-066028	3,5	6	28	66	2	○
1181065Z9	HBDPUE 2 05D 0360-066028	3,6	6	28	66	2	○
1181066Z9	HBDPUE 2 05D 0370-066028	3,7	6	28	66	2	○
1181067Z9	HBDPUE 2 05D 0380-074036	3,8	6	36	74	2	○
1180795Z9	HBDPUE 2 05D 0390-074036	3,9	6	36	74	2	○
1181068Z9	HBDPUE 2 05D 0400-074036	4	6	36	74	2	○
1181069Z9	HBDPUE 2 05D 0410-074036	4,1	6	36	74	2	○
1180785Z9	HBDPUE 2 05D 0420-074036	4,2	6	36	74	2	○
1181070Z9	HBDPUE 2 05D 0430-074036	4,3	6	36	74	2	○
1181071Z9	HBDPUE 2 05D 0440-074036	4,4	6	36	74	2	○
1181072Z9	HBDPUE 2 05D 0450-074036	4,5	6	36	74	2	○
1181073Z9	HBDPUE 2 05D 0460-074036	4,6	6	36	74	2	○
1180786Z9	HBDPUE 2 05D 0470-074036	4,7	6	36	74	2	○
1181074Z9	HBDPUE 2 05D 0480-082044	4,8	6	44	82	2	○
1181075Z9	HBDPUE 2 05D 0490-082044	4,9	6	44	82	2	○
1180782Z9	HBDPUE 2 05D 0500-082044	5	6	44	82	2	○
1181076Z9	HBDPUE 2 05D 0510-082044	5,1	6	44	82	2	○
1181077Z9	HBDPUE 2 05D 0520-082044	5,2	6	44	82	2	○
1181078Z9	HBDPUE 2 05D 0530-082044	5,3	6	44	82	2	○
1181079Z9	HBDPUE 2 05D 0540-082044	5,4	6	44	82	2	○

Order code Código	Reference Referência Referencia	Dimensions Dimensões Dimensiones (mm)				Z	PHU920
		ØD	Ø ds	L1	L		
1181080Z9	HBDPUE 2 05D 0550-082044	5,5	6	44	82	2	○
1181081Z9	HBDPUE 2 05D 0560-082044	5,6	6	44	82	2	○
1181082Z9	HBDPUE 2 05D 0570-082044	5,7	6	44	82	2	○
1181083Z9	HBDPUE 2 05D 0580-082044	5,8	6	44	82	2	○
1181084Z9	HBDPUE 2 05D 0590-082044	5,9	6	44	82	2	○
1181085Z9	HBDPUE 2 05D 0600-082044	6	6	44	82	2	○
1181086Z9	HBDPUE 2 05D 0610-091053	6,1	8	53	91	2	○
1181087Z9	HBDPUE 2 05D 0620-091053	6,2	8	53	91	2	○
1181088Z9	HBDPUE 2 05D 0630-091053	6,3	8	53	91	2	○
1181089Z9	HBDPUE 2 05D 0640-091053	6,4	8	53	91	2	○
1181090Z9	HBDPUE 2 05D 0650-091053	6,5	8	53	91	2	○
1181091Z9	HBDPUE 2 05D 0660-091053	6,6	8	53	91	2	○
1181092Z9	HBDPUE 2 05D 0670-091053	6,7	8	53	91	2	○
1180781Z9	HBDPUE 2 05D 0680-091053	6,8	8	53	91	2	○
1181093Z9	HBDPUE 2 05D 0690-091053	6,9	8	53	91	2	○
1181094Z9	HBDPUE 2 05D 0700-091053	7	8	53	91	2	○
1181095Z9	HBDPUE 2 05D 0710-091053	7,1	8	53	91	2	○
1181096Z9	HBDPUE 2 05D 0720-091053	7,2	8	53	91	2	○
1181097Z9	HBDPUE 2 05D 0730-091053	7,3	8	53	91	2	○
1181098Z9	HBDPUE 2 05D 0740-091053	7,4	8	53	91	2	○
1181099Z9	HBDPUE 2 05D 0750-091053	7,5	8	53	91	2	○
1181100Z9	HBDPUE 2 05D 0760-091053	7,6	8	53	91	2	○
1181101Z9	HBDPUE 2 05D 0770-091053	7,7	8	53	91	2	○
1181102Z9	HBDPUE 2 05D 0780-091053	7,8	8	53	91	2	○
1181103Z9	HBDPUE 2 05D 0790-091053	7,9	8	53	91	2	○

Stock item | Produto de stock
Itens de stock

Available under request | Disponível sobre consulta
Disponível bajo consulta

Order code Código	Reference Referência Referencia	Dimensions Dimensões Dimensiones (mm)				Z	PHU920
		ØD	Ø ds	L1	L		
1181104Z9	HBDPUE 2 05D 0800-091053	8	8	53	91	2	○
1181105Z9	HBDPUE 2 05D 0810-103061	8,1	10	61	103	2	○
1181106Z9	HBDPUE 2 05D 0820-103061	8,2	10	61	103	2	○
1181107Z9	HBDPUE 2 05D 0830-103061	8,3	10	61	103	2	○
1181108Z9	HBDPUE 2 05D 0840-103061	8,4	10	61	103	2	○
1181109Z9	HBDPUE 2 05D 0850-103061	8,5	10	61	103	2	○
1181110Z9	HBDPUE 2 05D 0860-103061	8,6	10	61	103	2	○
1181111Z9	HBDPUE 2 05D 0870-103061	8,7	10	61	103	2	○
1181112Z9	HBDPUE 2 05D 0880-103061	8,8	10	61	103	2	○
1181113Z9	HBDPUE 2 05D 0890-103061	8,9	10	61	103	2	○
1181114Z9	HBDPUE 2 05D 0900-103061	9	10	61	103	2	○
1181115Z9	HBDPUE 2 05D 0910-103061	9,1	10	61	103	2	○
1181116Z9	HBDPUE 2 05D 0920-103061	9,2	10	61	103	2	○
1181117Z9	HBDPUE 2 05D 0930-103061	9,3	10	61	103	2	○
1181118Z9	HBDPUE 2 05D 0940-103061	9,4	10	61	103	2	○
1181119Z9	HBDPUE 2 05D 0950-103061	9,5	10	61	103	2	○
1181120Z9	HBDPUE 2 05D 0960-103061	9,6	10	61	103	2	○
1181121Z9	HBDPUE 2 05D 0970-103061	9,7	10	61	103	2	○
1181122Z9	HBDPUE 2 05D 0980-103061	9,8	10	61	103	2	○
1181123Z9	HBDPUE 2 05D 0990-103061	9,9	10	61	103	2	○
1181124Z9	HBDPUE 2 05D 1000-103061	10	10	61	103	2	○
1181125Z9	HBDPUE 2 05D 1010-118071	10,1	12	71	118	2	○
1181126Z9	HBDPUE 2 05D 1020-118071	10,2	12	71	118	2	○
1181127Z9	HBDPUE 2 05D 1030-118071	10,3	12	71	118	2	○
1181128Z9	HBDPUE 2 05D 1040-118071	10,4	12	71	118	2	○
1180796Z9	HBDPUE 2 05D 1050-118071	10,5	12	71	118	2	○
1181129Z9	HBDPUE 2 05D 1060-118071	10,6	12	71	118	2	○
1181130Z9	HBDPUE 2 05D 1070-118071	10,7	12	71	118	2	○
1181131Z9	HBDPUE 2 05D 1080-118071	10,8	12	71	118	2	○
1181132Z9	HBDPUE 2 05D 1090-118071	10,9	12	71	118	2	○
1181133Z9	HBDPUE 2 05D 1100-118071	11	12	71	118	2	○
1181134Z9	HBDPUE 2 05D 1110-118071	11,1	12	71	118	2	○
1181135Z9	HBDPUE 2 05D 1120-118071	11,2	12	71	118	2	○
1181136Z9	HBDPUE 2 05D 1130-118071	11,3	12	71	118	2	○
1181137Z9	HBDPUE 2 05D 1140-118071	11,4	12	71	118	2	○
1181138Z9	HBDPUE 2 05D 1150-118071	11,5	12	71	118	2	○
1181139Z9	HBDPUE 2 05D 1160-118071	11,6	12	71	118	2	○
1181140Z9	HBDPUE 2 05D 1170-118071	11,7	12	71	118	2	○
1181141Z9	HBDPUE 2 05D 1180-118071	11,8	12	71	118	2	○
1181142Z9	HBDPUE 2 05D 1190-118071	11,9	12	71	118	2	○
1181143Z9	HBDPUE 2 05D 1200-118071	12	12	71	118	2	○
1181144Z9	HBDPUE 2 05D 1250-124077	12,5	14	77	124	2	○
1181145Z9	HBDPUE 2 05D 1300-124077	13	14	77	124	2	○
1181146Z9	HBDPUE 2 05D 1350-124077	13,5	14	77	124	2	○
1181147Z9	HBDPUE 2 05D 1400-124077	14	14	77	124	2	○

Order code Código	Reference Referência Referencia	Dimensions Dimensões Dimensiones (mm)				Z	PHU920
		ØD	Ø ds	L1	L		
1181148Z9	HBDPUE 2 05D 1450-133083	14,5	16	83	133	2	○
1181149Z9	HBDPUE 2 05D 1500-133083	15	16	83	133	2	○
1181150Z9	HBDPUE 2 05D 1550-133083	15,5	16	83	133	2	○
1181151Z9	HBDPUE 2 05D 1600-133083	16	16	83	133	2	○
1181152Z9	HBDPUE 2 05D 1650-143093	16,5	18	93	143	2	○
1181153Z9	HBDPUE 2 05D 1700-143093	17	18	93	143	2	○
1181154Z9	HBDPUE 2 05D 1750-143093	17,5	18	93	143	2	○
1181155Z9	HBDPUE 2 05D 1800-143093	18	18	93	143	2	○
1181156Z9	HBDPUE 2 05D 1850-153101	18,5	20	101	153	2	○
1181157Z9	HBDPUE 2 05D 1900-153101	19	20	101	153	2	○
1181158Z9	HBDPUE 2 05D 1950-153101	19,5	20	101	153	2	○
1181159Z9	HBDPUE 2 05D 2000-153101	20	20	101	153	2	○

Stock item | Produto de stock
Itens de stock

Available under request | Disponível sobre consulta
Disponível bajo consulta

HBDPCE 2 08D

DRILLING

Jet Drills

Integrex Drills

Vortex Drills

Trepanning Drills

Solid Carbide Drills

Inserts

Spare Parts

Technical Data



P	K
HRC ≤ 48	IT8-9 IT class

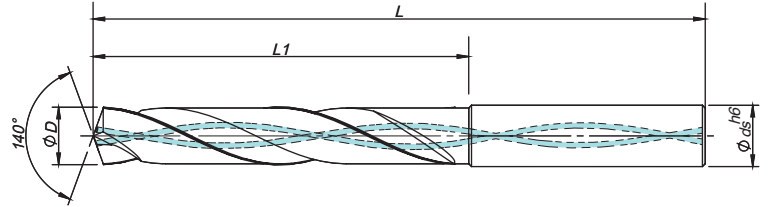

Drill Dia. ØD	5,0<ØD≤6,0	6,0<ØD≤10,0	10,0<ØD≤12,0
Hole Tolerances	+0,004	+0,006	+0,007
	+0,016	+0,021	+0,025

Order code Código	Reference Referência Referencia	Dimensions Dimensões Dimensiones (mm)				Z	PHU920
		ØD	Ø ds	L1	L		
1181246Z9	HBDPCE 2 08D 0300-072034	3	6	34	72	2	○
1181247Z9	HBDPCE 2 08D 0310-072034	3,1	6	34	72	2	○
1181248Z9	HBDPCE 2 08D 0320-072034	3,2	6	34	72	2	○
1181249Z9	HBDPCE 2 08D 0330-072034	3,3	6	34	72	2	○
1181250Z9	HBDPCE 2 08D 0340-072034	3,4	6	34	72	2	○
1181251Z9	HBDPCE 2 08D 0350-072034	3,5	6	34	72	2	○
1181252Z9	HBDPCE 2 08D 0360-072034	3,6	6	34	72	2	○
1181253Z9	HBDPCE 2 08D 0370-072034	3,7	6	34	72	2	○
1181254Z9	HBDPCE 2 08D 0380-081043	3,8	6	43	81	2	○
1181255Z9	HBDPCE 2 08D 0390-081043	3,9	6	43	81	2	○
1181256Z9	HBDPCE 2 08D 0400-081043	4	6	43	81	2	○
1181257Z9	HBDPCE 2 08D 0410-081043	4,1	6	43	81	2	○
1181258Z9	HBDPCE 2 08D 0420-081043	4,2	6	43	81	2	○
1181259Z9	HBDPCE 2 08D 0430-081043	4,3	6	43	81	2	○
1181260Z9	HBDPCE 2 08D 0440-081043	4,4	6	43	81	2	○
1181261Z9	HBDPCE 2 08D 0450-081043	4,5	6	43	81	2	○
1181262Z9	HBDPCE 2 08D 0460-081043	4,6	6	43	81	2	○
1181263Z9	HBDPCE 2 08D 0470-081043	4,7	6	43	81	2	○
1181264Z9	HBDPCE 2 08D 0480-095057	4,8	6	57	95	2	○
1181265Z9	HBDPCE 2 08D 0490-095057	4,9	6	57	95	2	○
1181266Z9	HBDPCE 2 08D 0500-095057	5	6	57	95	2	○
1181267Z9	HBDPCE 2 08D 0510-095057	5,1	6	57	95	2	○
1181268Z9	HBDPCE 2 08D 0520-095057	5,2	6	57	95	2	○
1181269Z9	HBDPCE 2 08D 0530-095057	5,3	6	57	95	2	○
1181270Z9	HBDPCE 2 08D 0540-095057	5,4	6	57	95	2	○

Order code Código	Reference Referência Referencia	Dimensions Dimensões Dimensiones (mm)				Z	PHU920
		ØD	Ø ds	L1	L		
1181271Z9	HBDPCE 2 08D 0550-095057	5,5	6	57	95	2	○
1181272Z9	HBDPCE 2 08D 0560-095057	5,6	6	57	95	2	○
1181273Z9	HBDPCE 2 08D 0570-095057	5,7	6	57	95	2	○
1181274Z9	HBDPCE 2 08D 0580-095057	5,8	6	57	95	2	○
1181275Z9	HBDPCE 2 08D 0590-095057	5,9	6	57	95	2	○
1181276Z9	HBDPCE 2 08D 0600-095057	6	6	57	95	2	○
1181277Z9	HBDPCE 2 08D 0610-114076	6,1	8	76	114	2	○
1181278Z9	HBDPCE 2 08D 0620-114076	6,2	8	76	114	2	○
1181279Z9	HBDPCE 2 08D 0630-114076	6,3	8	76	114	2	○
1181280Z9	HBDPCE 2 08D 0640-114076	6,4	8	76	114	2	○
1181281Z9	HBDPCE 2 08D 0650-114076	6,5	8	76	114	2	○
1181282Z9	HBDPCE 2 08D 0660-114076	6,6	8	76	114	2	○
1181283Z9	HBDPCE 2 08D 0670-114076	6,7	8	76	114	2	○
1181284Z9	HBDPCE 2 08D 0680-114076	6,8	8	76	114	2	○
1181285Z9	HBDPCE 2 08D 0690-114076	6,9	8	76	114	2	○
1181286Z9	HBDPCE 2 08D 0700-114076	7	8	76	114	2	○
1181287Z9	HBDPCE 2 08D 0710-114076	7,1	8	76	114	2	○
1181288Z9	HBDPCE 2 08D 0720-114076	7,2	8	76	114	2	○
1181289Z9	HBDPCE 2 08D 0730-114076	7,3	8	76	114	2	○
1181290Z9	HBDPCE 2 08D 0740-114076	7,4	8	76	114	2	○
1181291Z9	HBDPCE 2 08D 0750-114076	7,5	8	76	114	2	○
1181292Z9	HBDPCE 2 08D 0760-114076	7,6	8	76	114	2	○
1181293Z9	HBDPCE 2 08D 0770-114076	7,7	8	76	114	2	○
1181294Z9	HBDPCE 2 08D 0780-114076	7,8	8	76	114	2	○
1181295Z9	HBDPCE 2 08D 0790-114076	7,9	8	76	114	2	○

Stock item | Produto de stock / Available under request | Disponível sobre consulta / Disponible bajo consulta

Order code Código	Reference Referência Referencia	Dimensions Dimensões Dimensiones (mm)				Z	PHU920
		ØD	Ø ds	L1	L		
1181296Z9	HBDPCE 2 08D 0800-114076	8	8	76	114	2	○
1181297Z9	HBDPCE 2 08D 0810-142095	8,1	10	95	142	2	○
1181298Z9	HBDPCE 2 08D 0820-142095	8,2	10	95	142	2	○
1181299Z9	HBDPCE 2 08D 0830-142095	8,3	10	95	142	2	○
1181300Z9	HBDPCE 2 08D 0840-142095	8,4	10	95	142	2	○
1181301Z9	HBDPCE 2 08D 0850-142095	8,5	10	95	142	2	○
1181302Z9	HBDPCE 2 08D 0860-142095	8,6	10	95	142	2	○
1181303Z9	HBDPCE 2 08D 0870-142095	8,7	10	95	142	2	○
1181304Z9	HBDPCE 2 08D 0880-142095	8,8	10	95	142	2	○
1181305Z9	HBDPCE 2 08D 0890-142095	8,9	10	95	142	2	○
1181306Z9	HBDPCE 2 08D 0900-142095	9	10	95	142	2	○
1181307Z9	HBDPCE 2 08D 0910-142095	9,1	10	95	142	2	○
1181308Z9	HBDPCE 2 08D 0920-142095	9,2	10	95	142	2	○
1181309Z9	HBDPCE 2 08D 0930-142095	9,3	10	95	142	2	○
1181310Z9	HBDPCE 2 08D 0940-142095	9,4	10	95	142	2	○
1181311Z9	HBDPCE 2 08D 0950-142095	9,5	10	95	142	2	○
1181312Z9	HBDPCE 2 08D 0960-142095	9,6	10	95	142	2	○
1181313Z9	HBDPCE 2 08D 0970-142095	9,7	10	95	142	2	○
1181314Z9	HBDPCE 2 08D 0980-142095	9,8	10	95	142	2	○
1181315Z9	HBDPCE 2 08D 0990-142095	9,9	10	95	142	2	○
1181316Z9	HBDPCE 2 08D 1000-142095	10	10	95	142	2	○
1181317Z9	HBDPCE 2 08D 1010-162114	10,1	12	114	162	2	○
1181318Z9	HBDPCE 2 08D 1020-162114	10,2	12	114	162	2	○
1181319Z9	HBDPCE 2 08D 1030-162114	10,3	12	114	162	2	○
1181320Z9	HBDPCE 2 08D 1040-162114	10,4	12	114	162	2	○
1181321Z9	HBDPCE 2 08D 1050-162114	10,5	12	114	162	2	○
1181322Z9	HBDPCE 2 08D 1060-162114	10,6	12	114	162	2	○
1181323Z9	HBDPCE 2 08D 1070-162114	10,7	12	114	162	2	○
1181324Z9	HBDPCE 2 08D 1080-162114	10,8	12	114	162	2	○
1181325Z9	HBDPCE 2 08D 1090-162114	10,9	12	114	162	2	○
1181326Z9	HBDPCE 2 08D 1100-162114	11	12	114	162	2	○
1181327Z9	HBDPCE 2 08D 1110-162114	11,1	12	114	162	2	○
1181328Z9	HBDPCE 2 08D 1120-162114	11,2	12	114	162	2	○
1181329Z9	HBDPCE 2 08D 1130-162114	11,3	12	114	162	2	○
1181330Z9	HBDPCE 2 08D 1140-162114	11,4	12	114	162	2	○
1181331Z9	HBDPCE 2 08D 1150-162114	11,5	12	114	162	2	○
1181332Z9	HBDPCE 2 08D 1160-162114	11,6	12	114	162	2	○
1181333Z9	HBDPCE 2 08D 1170-162114	11,7	12	114	162	2	○
1181334Z9	HBDPCE 2 08D 1180-162114	11,8	12	114	162	2	○
1181335Z9	HBDPCE 2 08D 1190-162114	11,9	12	114	162	2	○
1181336Z9	HBDPCE 2 08D 1200-162114	12	12	114	162	2	○

Stock item | Produto de stock
Itens de stock

Available under request | Disponível sobre consulta
Disponível bajo consulta

ISO DRILLING INSERTS CODE KEY

DRILLING
Jet Drills
Integrex Drills
Vortex Drills
Trepanning Drills
Solid Carbide Drills
Inserts
Spare Parts
Technical Data

H		M	
O		V	
P		W	
S		L	
T		A	
C		B	
D		K	
E		R	
F		X	Special

1- Insert shape symbol

Symbol	m (mm)	d (mm)	s (mm)
A	±0.005	±0.025	±0.025
F	±0.005	±0.013	±0.025
C	±0.013	±0.025	±0.025
H	±0.013	±0.013	±0.025
E	±0.025	±0.025	±0.025
G	±0.025	±0.025	±0.13
J	±0.005	±0.05~±0.13	±0.025
K*	±0.013	±0.05~±0.13	±0.025
L*	±0.025	±0.05~±0.13	±0.025
M*	±0.08~±0.20	±0.05~±0.13	±0.13
N*	±0.08~±0.20	±0.05~±0.13	±0.025
U*	±0.13~±0.38	±0.08~±0.25	±0.13

*As a rule, the sides of these inserts are as sintered. Tolerance differs with insert size, for the accuracy of class M, refer to the table on the right.

Triangular inserts with a facet (secondary cutting edge)

Detailed dimension of M class insert Insert height Tolerances (mm)					
Inscribed circle	T	S	C	D	V
6.35	±0.08	-	-	-	-
9.525	±0.08	±0.08	±0.11	±0.10	±0.13
12.70	±0.13	±0.13	±0.13	±0.15	-
15.875	±0.15	±0.15	±0.15	±0.18	-
19.05	±0.15	±0.15	±0.15	±0.18	-
25.40	-	±0.18	-	-	-
31.75	-	±0.25	-	-	-

Inscribed circle Tolerances (mm)					
Inscribed circle	T	S	C	D	V
6.35	±0.05	-	-	-	-
9.525	±0.05	±0.05	±0.05	±0.05	±0.05
12.70	±0.08	±0.08	±0.08	±0.08	±0.08
15.875	±0.10	±0.10	±0.10	±0.10	±0.10
19.05	-	-	-	-	±0.10
25.40	-	±0.13	-	-	±0.10
31.75	-	±0.20	-	-	±0.12

3 - Tolerances symbol

A	B	C	D	E
F	G	N	P	O
				Other clearance angle

2 - Normal clearance symbol

ISO **W C K X**

4 - Insert symbol															
symbol	Type	Hole type	Chipbreaker	Shape	symbol	Type	Hole type	Chipbreaker	Shape	symbol	Type	Hole type	Chipbreaker	Shape	
W	with hole	Round hole / one countersink (40°-60°)	Without chipbreaker		H	with hole	Round hole / one countersink (70°-90°)	Chipbreaker on one side		G	with hole	Round hole	Chipbreaker on both sides		
T			Chipbreaker on one side		C		Round hole / double countersink (70°-90°)	Without chipbreaker		N		-	Without chipbreaker		
Q		Round hole / double countersink (40°-60°)	Without chipbreaker		J		Round hole	Round hole	Without chipbreaker		R	without hole	-	Chipbreaker on one side	
U			Chipbreaker on both sides		A				Without chipbreaker		F		-	Chipbreaker on both sides	
B		Round hole / one countersink (70°-90°)	Without chipbreaker		M		Without chipbreaker		X	-	-	-	-	-	On request

R's	35° V's	55° D's	80° C's	90° S's	60° T's	80° W's	Ø CI		ANSI
							mm	inch	Symbol
-	06	04	-	03	06	02	3,97	5/32	1,20
-	08	05	04	04	08	L3	4,76	3/16	1,50
-	09	06	05	05	09	03	5,56	7/32	1,80
06**	-	-	-	-	-	-	6,00	0,236	
06*	11	07	06	06	11	04	6,35	1/4	2,00
07*	13	09	08	07	13	05	7,94	5/16	2,50
08*	-	-	-	-	-	-	8,00	0,315	
09*	16	11	09	09	16	06	9,525	3/8	3,00
10**	-	-	-	-	-	-	10,00	0,394	
12**	-	-	-	-	-	-	12,00	0,472	
12*	22	15	12	12	22	08	12,70	1/2	4,00
15*	27	19	16	15	27	10	15,875	5/8	5,00
16**	-	-	-	-	-	-	16,00	0,63	
19*	33	23	19	19	33	13	19,05	3/4	6,00
20**	-	-	-	-	-	-	20,00	0,787	
25**	-	-	-	-	-	-	25,00	0,984	
25*	44	31	25	25	44	17	25,40	1,00	8,00
31*	54	38	32	31	54	21	31,75	1 1/4	10,00
32**	-	-	-	-	-	-	32,00	1,26	

* ANSI designation only (Radius Designation is R00)

** Metric designation only (Radius Designation is M0)

According to International Standard ISO 1832 - 2012(E)

"Indexable inserts for cutting tools - Designation"

ISO	mm	ANSI	inch
01	1.59	1	0.062
T1	1.98	1.2	0.078
02	2.38	1.5	0.094
03	3.18	2	0.125
T3	3.97	2.5	0.156
04	4.76	3	0.188
05	5.56	3.5	0.219
06	6.35	4	0.250
07	7.94	5	0.312
09	9.52	6	0.375
12	12.70	8	0.500

5 - Insert size symbol

6 - Insert thickness symbol

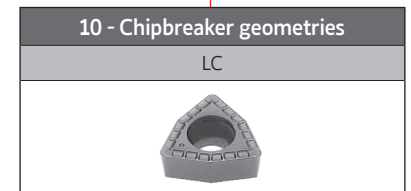

7 - Insert corner symbol			
ISO	mm	inch	ANSI
00	Sharp nose		0
01	0.10	.004	0.2
02	0.20	.008	0.5
04	0.40	.015	1
08	0.80	.032	2
12	1.2	.047	3
16	1.6	.062	4
20	2.0	.078	5
24	2.4	.094	6
28	2.8	.109	7
32	3.2	.125	8
00 (inch or M0/ metric)	Round insert		0

7.1* - Insert edges symbol			
For inserts having secondary edges two digits are used:			
1 st digit is secondary edge		2 nd digit is secondary edges relief angle	
A	45°	A	3°
D	60°	B	5°
E	75°	C	7°
F	85°	D	15°
P	90°	E	20°
Z	special	F	25°
*only when required.		G	30°
		N	0°
		P	11°
		Z	special

8 - Cutting edge information		
Shape	Honing	Symbol
	No honing	F
	With honing	E
	Chamfered No honing	T
	Chamfered with honing	S
*only when required.		

INSERTS

SPKX | Inserts | Pastilhas | Plaquetas

DRILLING

Jet Drills

Integrex Drills

Vortex Drills

Trepanning Drills

Solid Carbide Drills

Inserts

Spare Parts

Technical Data

(PHC grade)

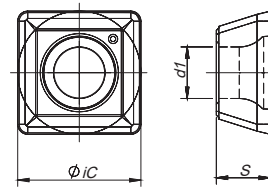

(1) Geometry code	ISO Reference	P			M			K		S			N	Dimensions Dimensões Dimensiones (mm)			
		PVD			PVD			PVD		PVD			UNC	iC	S	d1	R
		68	66	J3	68	66	J3	68	66	68	66	J3	10				
1111281	SPKX 050204	⊗	⊗	⊗	⊗	⊗	⊗	⊗	⊗	⊗	⊗	⊗	⊗	5,00	2,38	2,20	0,4
1111282	SPKX 060204	⊗	⊗	⊗	⊗	⊗	⊗	⊗	⊗	⊗	⊗	⊗	⊗	6,00	2,38	2,55	0,4
1142099	SPHX 060204-LN												⊗	6,00	2,38	2,55	0,4
1111283	SPKX 07T308	⊗	⊗	⊗	⊗	⊗	⊗	⊗	⊗	⊗	⊗	⊗	⊗	7,94	3,97	2,85	0,8
1111284	SPKX 090408	⊗	⊗	⊗	⊗	⊗	⊗	⊗	⊗	⊗	⊗	⊗	⊗	9,80	4,30	4,10	0,8
1111285	SPKX 110408	⊗	⊗	⊗	⊗	⊗	⊗	⊗	⊗	⊗	⊗	⊗	⊗	11,50	4,80	4,40	0,8
1111286	SPKX 140512	⊗	⊗	⊗	⊗	⊗	⊗	⊗	⊗	⊗	⊗	⊗	⊗	14,30	5,20	5,75	1,2

⊗ Stock item | Produto de stock | Itens de stock

○ Available under request | Disponível sobre consulta | Disponible bajo consulta

Insert order code = (1) Geometry Code + (2) Grade Code

WCKX | Inserts | Pastilhas | Plaquetas

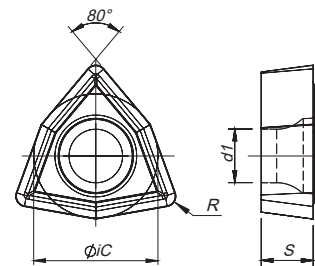

(1) Geometry code	ISO Reference	P				M		K		S		Dimensions Dimensões Dimensiones (mm)			
		PVD				PVD		CVD		PVD		iC	S	d1	R
		68	66	I5	78	68	66	68	66	68	66				
1140300	WCKX 02T104	⊗	⊗	○	○	⊗	⊗	⊗	⊗	⊗	⊗	4,76	1,98	2,00	0,4
1140276	WCKX 030204	⊗	⊗	○	○	⊗	⊗	⊗	⊗	⊗	⊗	5,56	2,38	2,55	0,4
1140277	WCKX 040204	⊗	⊗	○	○	⊗	⊗	⊗	⊗	⊗	⊗	6,35	2,38	2,85	0,4
1140278	WCKX 050308	⊗	⊗	○	○	⊗	⊗	⊗	⊗	⊗	⊗	7,94	3,18	3,50	0,8
1140279	WCKX 06T308	⊗	⊗	○	○	⊗	⊗	⊗	⊗	⊗	⊗	9,55	3,97	4,10	0,8
1140280	WCKX 080408	⊗	⊗	○	○	⊗	⊗	⊗	⊗	⊗	⊗	12,70	4,76	5,60	0,8

⊗ Stock item | Produto de stock | Itens de stock

○ Available under request | Disponível sobre consulta | Disponible bajo consulta

Insert order code = (1) Geometry Code + (2) Grade Code

WCKX-LC for low carbon steels | Inserts | Pastilhas | Plaquetas

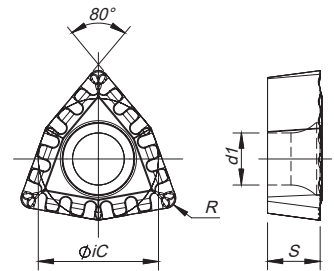

		P		Dimensions Dimensões Dimensiones (mm)			
		PVD					
	⁽²⁾ Grade code	68	66				
⁽¹⁾ Geometry code	ISO Reference	PH6920	PH6930	iC	S	d1	R
1142068	WCKX 050308-LC	⊗	⊗	7,94	3,18	3,50	0,8
1142069	WCKX 06T308-LC	⊗	⊗	9,55	3,97	4,10	0,8

⊗ Stock item | Produto de stock | Itens de stock ○ Available under request | Disponível sobre consulta | Disponible bajo consulta Insert order code = (1) Geometry Code + (2) Grade Code

WCMX | Inserts | Pastilhas | Plaquetas

ISO references for other drilling systems

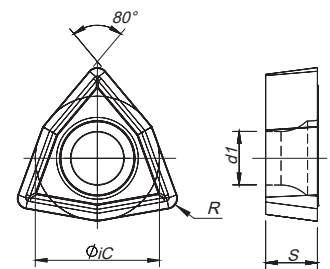
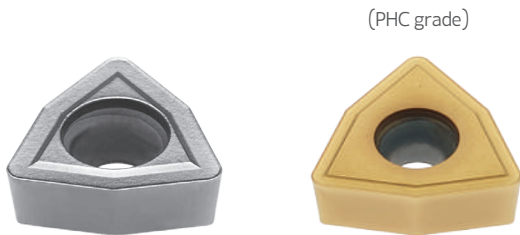

		P		M		K		S		Dimensions Dimensões Dimensiones (mm)			
		PVD		PVD		PVD		PVD					
		68	J3	68	J3	68	J3	68	J3				
⁽¹⁾ Geometry code	ISO Reference	PH6920	PHC930	PH6920	PHC930	PH6920	PHC930	PH6920	PHC930	iC	S	d1	R
1120827	WCMX 030204	○	○	○	○	○	○	○	○	5,56	2,38	2,8	0,4
1120828	WCMX 030208	⊗	⊗	⊗	⊗	⊗	⊗	⊗	⊗	5,56	2,38	2,8	0,8
1120829	WCMX 040208	⊗	⊗	⊗	⊗	⊗	⊗	⊗	⊗	6,35	2,38	3,1	0,8
1120830	WCMX 050308	⊗	⊗	⊗	⊗	⊗	⊗	⊗	⊗	7,94	3,18	3,2	0,8
1120831	WCMX 06T308	⊗	⊗	⊗	⊗	⊗	⊗	⊗	⊗	9,525	3,97	3,7	0,8
1120832	WCMX 080408	⊗	⊗	⊗	⊗	⊗	⊗	⊗	⊗	12,70	4,76	4,3	0,8
1120833	WCMX 080412	⊗	⊗	⊗	⊗	⊗	⊗	⊗	⊗	12,70	4,76	4,3	1,2

⊗ Stock item | Produto de stock | Itens de stock ○ Available under request | Disponível sobre consulta | Disponible bajo consulta Insert order code = (1) Geometry Code + (2) Grade Code

SPARE PARTS

CD

DRILLING

Jet Drills

Integrex Drills

Vortex Drills

Trepanning Drills

Solid Carbide Drills

Inserts

Spare Parts

Technical Data

SIZE ADAPTABLE CARTRIDGE (5mm)

- Unlock the clamping screw of the outer cartridge and move out the cartridge from the body.
- Cut off the outer cartridge's inside contacted part after calculation of the diameter that you want to drill.
- Slick the rough corner surface of the cut cartridge.
- Adhere closely the cartridge to the body not to make chink and fix it with the clamping screw firmly.

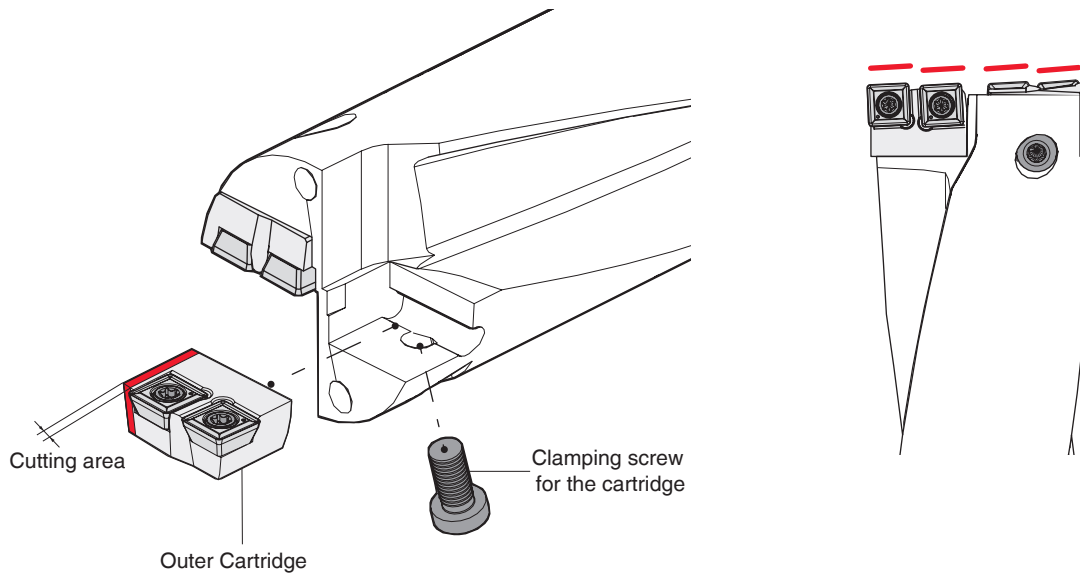

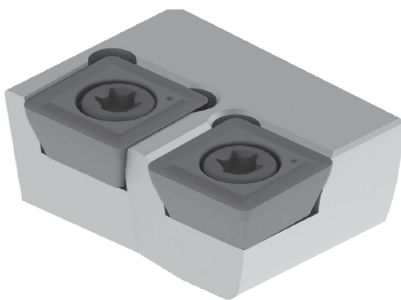

SCC CARTRIDGE (5mm)

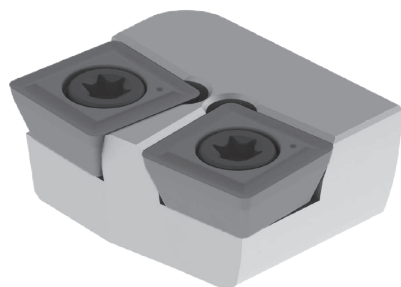

ØD	Inner Cartridge		Outer Cartridge		Insert	Insert Screw	Torx key	For Drill
	Order Code	Reference	Order Code	Reference				
50-55	184230600	SCC 050055-I	184230700	SCC 050055-O	SP... 090408	P0350903	XT15	SCC 505540-3D & 4D
55-60	184230800	SCC 055060-I	184230900	SCC 055060-O	SP... 090408	P0350903	XT15	SCC 556040-3D & 4D
60-65	184231000	SCC 060065-I	184231100	SCC 060065-O	SP... 110408	P0401200	XT15	SCC 606540-3D & 4D
65-70	184231200	SCC 065070-I	184231300	SCC 065070-O	SP... 110408	P0401200	XT15	SCC 657040-3D & 4D
70-75	184231400	SCC 070075-I	184231500	SCC 070075-O	SP... 110408	P0401200	XT15	SCC 707540-3D & 4D
75-80	184231600	SCC 075080-I	184231700	SCC 075080-O	SP... 140512	P0501300	XT20	SCC 758040-3D & 4D

SCC CARTRIDGE (1mm)



ØD	Inner Cartridge		Outer Cartridge		Insert	Insert Screw	Torx key	For Drill
	Order Code	Reference	Order Code	Reference				
50-51	184069500	CISP 5055	184070100	COSP 5051	SP... 090408	P0350903	XT15	SCC 505140-3D & 4D
51-52	184069500	CISP 5055	184070200	COSP 5152	SP... 090408	P0350903	XT15	SCC 515240-3D & 4D
52-53	184069500	CISP 5055	184070300	COSP 5253	SP... 090408	P0350903	XT15	SCC 525340-3D & 4D
53-54	184069500	CISP 5055	184070400	COSP 5354	SP... 090408	P0350903	XT15	SCC 535440-3D & 4D
54-55	184069500	CISP 5055	184070500	COSP 5455	SP... 090408	P0350903	XT15	SCC 545540-3D & 4D
55-56	184069600	CISP 5560	184070600	COSP 5556	SP... 090408	P0350903	XT15	SCC 555640-3D & 4D
56-57	184069600	CISP 5560	184070700	COSP 5657	SP... 090408	P0350903	XT15	SCC 565740-3D & 4D
57-58	184069600	CISP 5560	184070800	COSP 5758	SP... 090408	P0350903	XT15	SCC 575840-3D & 4D
58-59	184069600	CISP 5560	184070900	COSP 5859	SP... 090408	P0350903	XT15	SCC 585940-3D & 4D
59-60	184069600	CISP 5560	184071000	COSP 5960	SP... 090408	P0350903	XT15	SCC 596040-3D & 4D
60-61	184069700	CISP 6065	184071100	COSP 6061	SP... 110408	P0401200	XT15	SCC 606140-3D & 4D
61-62	184069700	CISP 6065	184071200	COSP 6162	SP... 110408	P0401200	XT15	SCC 616240-3D & 4D
62-63	184069700	CISP 6065	184071300	COSP 6263	SP... 110408	P0401200	XT15	SCC 626340-3D & 4D
63-64	184069700	CISP 6065	184071400	COSP 6364	SP... 110408	P0401200	XT15	SCC 636440-3D & 4D
64-65	184069700	CISP 6065	184071500	COSP 6465	SP... 110408	P0401200	XT15	SCC 646540-3D & 4D
65-66	184069800	CISP 6570	184071600	COSP 6566	SP... 110408	P0401200	XT15	SCC 656640-3D & 4D
66-67	184069800	CISP 6570	184071700	COSP 6667	SP... 110408	P0401200	XT15	SCC 666740-3D & 4D
67-68	184069800	CISP 6570	184071800	COSP 6768	SP... 110408	P0401200	XT15	SCC 676840-3D & 4D
68-69	184069800	CISP 6570	184071900	COSP 6869	SP... 110408	P0401200	XT15	SCC 686940-3D & 4D
69-70	184069800	CISP 6570	184072000	COSP 6970	SP... 110408	P0401200	XT15	SCC 697040-3D & 4D
70-71	184069900	CISP 7075	184250100	COSP 7071	SP... 110408	P0401200	XT15	SCC 707140-3D & 4D
71-72	184069900	CISP 7075	184072200	COSP 7172	SP... 110408	P0401200	XT15	SCC 717240-3D & 4D
72-73	184069900	CISP 7075	184072300	COSP 7273	SP... 110408	P0401200	XT15	SCC 727340-3D & 4D
73-74	184069900	CISP 7075	184072400	COSP 7374	SP... 110408	P0401200	XT15	SCC 737440-3D & 4D
74-75	184069900	CISP 7075	184072500	COSP 7475	SP... 110408	P0401200	XT15	SCC 747540-3D & 4D
75-76	184070000	CISP 7580	184072600	COSP 7576	SP... 140512	P0501300	XT20	SCC 757640-3D & 4D
76-77	184070000	CISP 7580	184072700	COSP 7677	SP... 140512	P0501300	XT20	SCC 767740-3D & 4D
77-78	184070000	CISP 7580	184072800	COSP 7778	SP... 140512	P0501300	XT20	SCC 777840-3D & 4D
78-79	184070000	CISP 7580	184072900	COSP 7879	SP... 140512	P0501300	XT20	SCC 787940-3D & 4D
79-80	184070000	CISP 7580	184073000	COSP 7980	SP... 140512	P0501300	XT20	SCC 798040-3D & 4D

SPARE PARTS

DHC CARTRIDGE

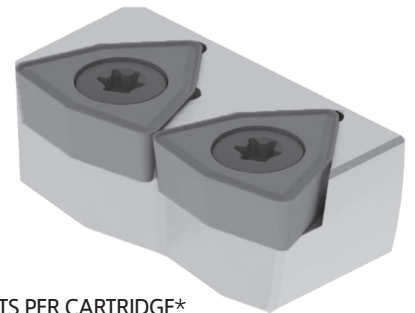
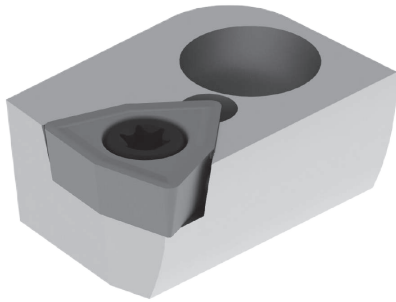

2 INSERTS PER CARTRIDGE*

ØD	Inner Cartridge		Outer Cartridge		Insert	Insert Screw	Torx key	For Drill
	Order Code	Reference	Order Code	Reference				
41	184250300	CWC 041045-I	184226700	CWC 000041-O	WC... 06T308	P0350903	XT15	DHC 004140-5D & 8D
42	184250300	CWC 041045-I	184226800	CWC 000042-O	WC... 06T308	P0350903	XT15	DHC 004240-5D & 8D
43	184250300	CWC 041045-I	184226900	CWC 000043-O	WC... 06T308	P0350903	XT15	DHC 004340-5D & 8D
44	184250300	CWC 041045-I	184227000	CWC 000044-O	WC... 06T308	P0350903	XT15	DHC 004440-5D & 8D
45	184250300	CWC 041045-I	184227100	CWC 000045-O	WC... 06T308	P0350903	XT15	DHC 004540-5D & 8D
46	184226400	CWC 046050-I	184227200	CWC 000046-O	WC... 06T308	P0350903	XT15	DHC 004640-5D & 8D
47	184226400	CWC 046050-I	184227300	CWC 000047-O	WC... 06T308	P0350903	XT15	DHC 004740-5D & 8D
48	184226400	CWC 046050-I	184227400	CWC 000048-O	WC... 06T308	P0350903	XT15	DHC 004840-5D & 8D
49	184226400	CWC 046050-I	184227500	CWC 000049-O	WC... 06T308	P0350903	XT15	DHC 004940-5D & 8D
50	184226400	CWC 046050-I	184227600	CWC 000050-O	WC... 06T308	P0350903	XT15	DHC 005040-5D & 8D
51	184226500	CWC 051055-I	184227700	CWC 000051-O	WC... 080408	P0401101	XT15	DHC 005140-5D & 8D
52	184226500	CWC 051055-I	184227800	CWC 000052-O	WC... 080408	P0401101	XT15	DHC 005240-5D & 8D
53	184226500	CWC 051055-I	184227900	CWC 000053-O	WC... 080408	P0401101	XT15	DHC 005340-5D & 8D
54	184226500	CWC 051055-I	184228000	CWC 000054-O	WC... 080408	P0401101	XT15	DHC 005440-5D & 8D
55	184226500	CWC 051055-I	184228100	CWC 000055-O	WC... 080408	P0401101	XT15	DHC 005540-5D & 8D
56	184226600	CWC 056059-I	184228200	CWC 000056-O	WC... 080408	P0401101	XT15	DHC 005640-5D & 8D
57	184226600	CWC 056059-I	184228300	CWC 000057-O	WC... 080408	P0401101	XT15	DHC 005740-5D & 8D
58	184226600	CWC 056059-I	184228400	CWC 000058-O	WC... 080408	P0401101	XT15	DHC 005840-5D & 8D
59	184226600	CWC 056059-I	184228500	CWC 000059-O	WC... 080408	P0401101	XT15	DHC 005940-5D & 8D
2 INSERTS PER CARTRIDGE*								
60-65	184250600*	MDC 060065-I	184252900*	MDC 060065-O	WC... 050308	P0300701	XT08	DHC 606540-5D & 8D
65-70	184250700*	MDC 065070-I	184253000*	MDC 065070-O	WC... 050308	P0300701	XT08	DHC 657040-5D & 8D
70-75	184250800*	MDC 070075-I	184063700*	MDC 070075-O	WC... 050308	P0300701	XT08	DHC 707540-5D & 8D
75-80	184250900*	MDC 075080-I	184063800*	MDC 075080-O	WC... 06T308	P0350903	XT15	DHC 758040-5D & 8D

DRILLING

DRILLING

Jet Drills

Integrex Drills

Vortex Drills

Trepanning Drills

Solid Carbide Drills



Inserts

Spare Parts

Technical Data

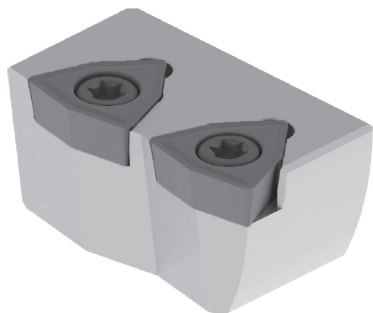

TDC CARTRIDGE

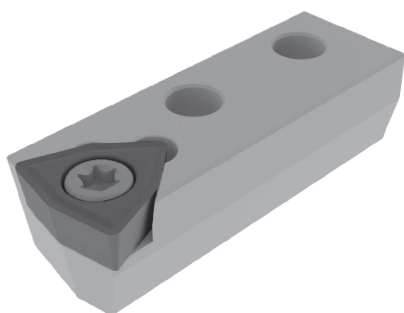

ØD	Inner Cartridge		Outer Cartridge		Insert	Insert Screw	Torx key	For Drill
	Order Code	Reference	Order Code	Reference				
59-65	184109200	TDC 059065-I	184109300	TDC 059065-O	WC... 06T308	P0350903	XT15	TDC 596540-3D
65-70	184109400	TDC 065070-I	184109500	TDC 065070-O	WC... 06T308	P0350903	XT15	TDC 657040-3D
70-75	184109600	TDC 070075-I	184109700	TDC 070075-O	WC... 06T308	P0350903	XT15	TDC 707540-3D
75-80	184109800	TDC 075080-I	184109900	TDC 075080-O	WC... 06T308	P0350903	XT15	TDC 758040-3D

PND CARTRIDGE



ØD	Inner Cartridge		Outer Cartridge		Insert	Insert Screw	Torx key	For Drill
	Order Code	Reference	Order Code	Reference				
40-55	184110000	PNC 040055-I	184128700	PNC 040055-O	WC... 050308	P0300701	XT08	PND 04032-2D ~ PND 05540-2D
60-110	184110100	PNC 060110-I	184128800	PNC 060110-O	WC... 06T308	P0350903	XT15	PND 06040-2D ~ PND 11050-2D

SPARE PARTS

SCREWS & KEYS

DRILLING
Jet Drills
Integrex Drills
Vortex Drills
Trepanning Drills
Solid Carbide Drills
Inserts
Spare Parts
Technical Data



Screw for Cartridge (DIN 912)

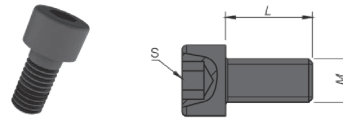

Order Code	Reference Referência Referencia
290031400	P0200500
290030600	P0220500
290031300	P0250704
290030900	P0350903
290047500	P0401200
290031700	P0501300
290025800	P0180500
290033100	P0250503
290030800	P0300701
290031000	P0401101

Order Code	Reference Referência Referencia
290011400	XT06
290012900	XT07
290011700	XT08
290025700	XT09
290012400	XT15
290013200	XT20
290074700	TT15
290056000	TT20
290056100	TT25

Order Code Código	Screw	Dimensions (mm) Dimensões (mm) Dimensiones (mm)		
		M	L	S
290042800	P0501079	M4 x 0,7	10,0	2,0
290042900	P0501279	M5 x 0,8	12,0	2,5
290043000	P0601279	M6 x 1,0	12,0	2,5
290043100	P0601479	M6 x 1,0	14,0	3,0
290043600	P0601679	M6 x 1,0	16,0	3,0
290043300	P0801879	M8 x 1,25	18,0	4,0
290043400	P0802079	M8 x 1,25	20,0	4,0
290043500	P0802579	M8 x 1,25	25,0	4,0

Screw for Cartridge (ISO 7380)

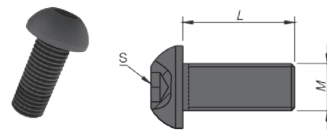

Fixing Screw and Clamping Bolt for Pilot Drill (DIN 916)

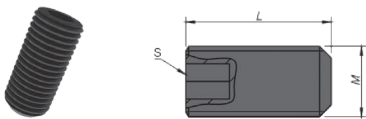

Order Code Código	Screw	Dimensions (mm) Dimensões (mm) Dimensiones (mm)		
		M	L	S
290040100	P0400875	M4 x 0,7	8,0	2,0
290040200	P0500875	M5 x 0,8	8,0	2,5
290040300	P0501075	M5 x 0,8	10,0	2,5
290040400	P0601075	M6 x 1,0	10,0	3,0
290040500	P0601275	M6 x 1,0	12,0	3,0
290040600	P0801275	M8 x 1,25	12,0	4,0
290040700	P0801575	M8 x 1,25	15,0	4,0
290040800	P1001575	M10 x 1,5	15,0	5,0
290040900	P1002075	M10 x 1,5	20,0	5,0
290041000	P1202075	M12 x 1,75	20,0	6,0
290041100	P1202575	M12 x 1,75	25,0	6,0
290041200	P1402575	M14 x 2,0	25,0	6,0
290041300	P1602575	M16 x 2,0	25,0	8,0

Adjustment Screw for Pilot Drill (DIN 916 w/ hole)

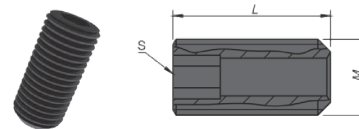

Order Code Código	Screw	Dimensions (mm) Dimensões (mm) Dimensiones (mm)		
		M	L	S
290041400	P0601076	M6 x 1,0	10,0	3,0
290041500	P0801576	M8 x 1,25	15,0	4,0
290041600	P1001676	M10 x 1,5	16,0	5,0
290041700	P1001876	M10 x 1,5	18,0	5,0
290041800	P1202076	M12 x 1,75	20,0	6,0
290041900	P1402076	M14 x 2,0	20,0	6,0

VORTEX SPARE PARTS - MDO CARTRIDGE

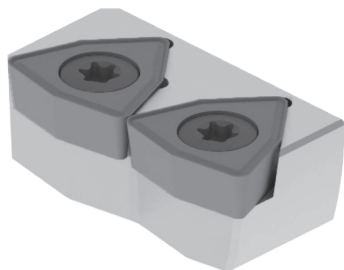

ØD	Inner Cartridge		Outer Cartridge		Insert	Insert Screw	Torx key	For Drill
	Order Code	Reference	Order Code	Reference				
2 INSERTS PER CARTRIDGE								
45-50	184062000	MDC 045050-I	184252600	MDC 045050-O	WC... 030204	P0220500	XT07	MDO 04505013
50-55	184250400	MDC 050055-I	184252700	MDC 050055-O	WC... 030204	P0220500	XT07	MDO 05005513
55-60	184250500	MDC 055060-I	184252800	MDC 055060-O	WC... 040204	P0250503	XT08	MDO 05506016
60-65	184250600	MDC 060065-I	184252900	MDC 060065-O	WC... 050308	P0300701	XT08	MDO 06006516
65-70	184250700	MDC 065070-I	184253000	MDC 065070-O	WC... 050308	P0300701	XT08	MDO 06507016
70-75	184250800	MDC 070075-I	184063700	MDC 070075-O	WC... 050308	P0300701	XT08	MDO 07007522
75-80	184250900	MDC 075080-I	184063800	MDC 075080-O	WC... 06T308	P0350903	XT15	MDO 07508022
80-85	184251000	MDC 080085-I	184063900	MDC 080085-O	WC... 06T308	P0350903	XT15	MDO 08008522
85-90	184251100	MDC 085090-I	184064000	MDC 085090-O	WC... 06T308	P0350903	XT15	MDO 08509027
90-95	184251200	MDC 090095-I	184064100	MDC 090095-O	WC... 06T308	P0350903	XT15	MDO 09009527
95-100	184251300	MDC 095100-I	184064200	MDC 095100-O	WC... 06T308	P0350903	XT15	MDO 09510027
3 INSERTS PER CARTRIDGE								
100-105	184251400	MDC 100105-I	184064300	MDC 100105-O	WC... 050308	P0300701	XT08	MDO 10010532
105-110	184251500	MDC 105110-I	184253100	MDC 105110-O	WC... 06T308	P0350903	XT15	MDO 10511032
110-115	184251600	MDC 110115-I	184253200	MDC 110115-O	WC... 06T308	P0350903	XT15	MDO 11011532
115-120	184251700	MDC 115120-I	184253300	MDC 115120-O	WC... 06T308	P0350903	XT15	MDO 11512040
120-125	184251800	MDC 120125-I	184253400	MDC 120125-O	WC... 06T308	P0350903	XT15	MDO 12012540
125-130	184251900	MDC 125130-I	184253500	MDC 125130-O	WC... 06T308	P0350903	XT15	MDO 12513040
130-135	184252000	MDC 130135-I	184068900	MDC 130135-O	WC... 06T308	P0350903	XT15	MDO 13013540
135-140	184252100	MDC 135140-I	184069000	MDC 135140-O	WC... 06T308	P0350903	XT15	MDO 13514040
140-150	184252200	MDC 140150-I	184253600	MDC 140150-O	WC... 080408	P0401101	XT15	MDO 14015050
150-160	184252300	MDC 150160-I	184069200	MDC 150160-O	WC... 080408	P0401101	XT15	MDO 15016050
160-170	184252400	MDC 160170-I	184069300	MDC 160170-O	WC... 080408	P0401101	XT15	MDO 16017050
170-180	184252500	MDC 170180-I	184069400	MDC 170180-O	WC... 080408	P0401101	XT15	MDO 17018050

SPARE PARTS

VORTEX SPARE PARTS - SCREWS

Vortex Drill	(3) Fixing Screw for Pilot Drill		(4) Clamping Bolt for Pilot Drill		(5) Adjustment Screw for Pilot Drill		(7) Screw for Cartridge	
	Order Code	Screw	Order Code	Screw	Order Code	Screw	Order Code	Screw
MDO 04505013	290040100	P0400875	290040400	P0601075	290041400	P0601076	290042500	P0401078
MDO 05005513	290040100	P0400875	290040400	P0601075	290041400	P0601076	290042500	P0401078
MDO 05506016	290040100	P0400875	290040600	P0801275	290041500	P0801576	290042700	P0501278
MDO 06006516	290040200	P0500875	290040600	P0801275	290041500	P0801576	290042700	P0501278
MDO 06507016	290040200	P0500875	290040600	P0801275	290041500	P0801576	290042700	P0501278
MDO 07007522	290040200	P0500875	290040700	P0801575	290041500	P0801576	290042700	P0501278
MDO 07508022	290040400	P0601075	290040900	P1002075	290041600	P1001676	290043000	P0601279
MDO 08008522	290040400	P0601075	290040900	P1002075	290041600	P1001676	290043100	P0601479
MDO 08509027	290040400	P0601075	290040900	P1002075	290041700	P1001876	290043600	P0601679
MDO 09009527	290040400	P0601075	290040900	P1002075	290041700	P1001876	290043600	P0601679
MDO 09510027	290040400	P0601075	290040900	P1002075	290041700	P1001876	290043600	P0601679
MDO 10010532	290040400	P0601075	290041000	P1202075	290041800	P1202076	290043300	P0801879
MDO 10511032	290040400	P0601075	290041000	P1202075	290041800	P1202076	290043300	P0801879
MDO 11011532	290040400	P0601075	290041000	P1202075	290041800	P1202076	290043300	P0801879
MDO 11512040	290040400	P0601075	290041100	P1202575	290041900	P1402076	290043400	P0802079
MDO 12012540	290040400	P0601075	290041200	P1402575	290041900	P1402076	290043500	P0802579
MDO 12513040	290040400	P0601075	290041200	P1402575	290041900	P1402076	290043500	P0802579
MDO 13013540	290040400	P0601075	290041200	P1402575	290041900	P1402076	290043500	P0802579
MDO 13514040	290040400	P0601075	290041200	P1402575	290041900	P1402076	290043500	P0802579
MDO 14015050	290040400	P0601075	290041200	P1402575	290041900	P1402076	290043500	P0802579
MDO 15016050	290040400	P0601075	290041200	P1402575	290041900	P1402076	290043500	P0802579
MDO 16017050	290040400	P0601075	290041300	P1602575	290041900	P1402076	290043500	P0802579
MDO 17018050	290040400	P0601075	290041300	P1602575	290041900	P1402076	290043500	P0802579

(9) Fixation Screw for MDS Shank, MDE Extension, MDM Reducer		
ØD / ØD1	Order Code Código	Screw
28	290032400	P0801280
32	290032400	P0801280
40	290032500	P1001580
48	290032600	P1201880
58	290039600	P1202080
70	290032800	P1602780
80	290032800	P1602780

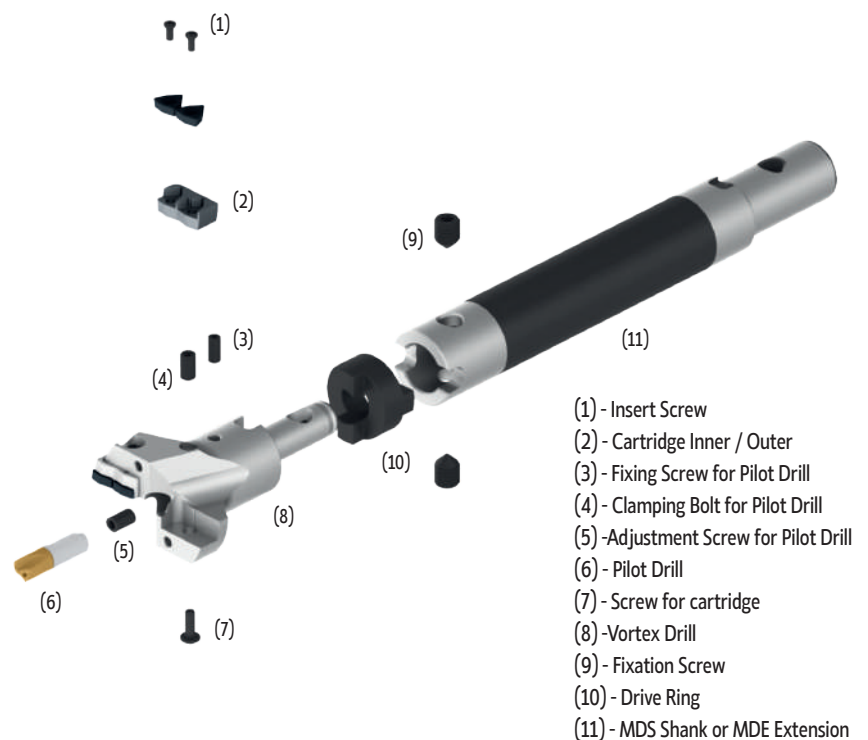

Fixing Screw and Clamping Bolt for Pilot Drill (DIN 916)

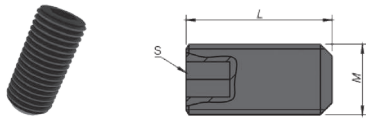

Order Code Código	Screw	Dimensions (mm) Dimensões (mm) Dimensiones (mm)		
		M	L	S
290040100	P0400875	M4 x 0,7	8,0	2,0
290040200	P0500875	M5 x 0,8	8,0	2,5
290040400	P0601075	M6 x 1,0	10,0	3,0
290040500	P0601275	M6 x 1,0	12,0	3,0
290040700	P0801575	M8 x 1,25	15,0	4,0
290040900	P1002075	M10 x 1,5	20,0	5,0
290041000	P1202075	M12 x 1,75	20,0	6,0
290041100	P1202575	M12 x 1,75	25,0	6,0
290041200	P1402575	M14 x 2,0	25,0	6,0
290041300	P1602575	M16 x 2,0	25,0	8,0

Fixation Screw for MDS Shank, MDE Extension, MDM Reducer

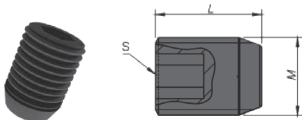

Order Code Código	Screw	Dimensions (mm) Dimensões (mm) Dimensiones (mm)		
		M	L	S
290032400	P0801280	M8	12,0	4,0
290032500	P1001580	M10	15,0	5,0
290032600	P1201880	M12	18,0	6,0
290039600	P1202080	M12	20,0	6,0
290032800	P1602780	M16	27,0	8,0

Insert Screw



Order Code	Screw
290030600	P0220500
290033100	P0250503
290030800	P0300701
290030900	P0350903
290031000	P0401101

Adjustment Screw for Pilot Drill (DIN 916 w/ hole)

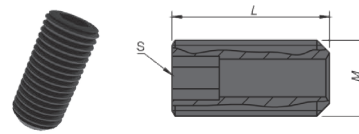

Order Code Código	Screw	Dimensions (mm) Dimensões (mm) Dimensiones (mm)		
		M	L	S
290041400	P0601076	M6 x 1,0	10,0	3,0
290041500	P0801576	M8 x 1,25	15,0	4,0
290041600	P1001676	M10 x 1,5	16,0	5,0
290041700	P1001876	M10 x 1,5	18,0	5,0
290041800	P1202076	M12 x 1,75	20,0	6,0
290041900	P1402076	M14 x 2,0	20,0	6,0

Screw for Cartridge (ISO 7380)

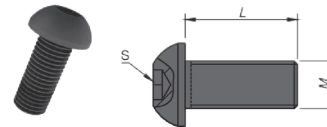

Order Code Código	Screw	Dimensions (mm) Dimensões (mm) Dimensiones (mm)		
		M	L	S
290042500	P0401078	M4 x 0,7	10,0	2,0
290042700	P0501278	M5 x 0,8	12,0	2,5

Screw for Cartridge (DIN 912)

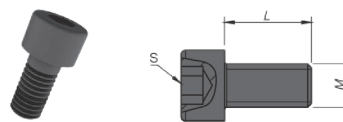

Order Code Código	Screw	Dimensions (mm) Dimensões (mm) Dimensiones (mm)		
		M	L	S
290043000	P0601279	M6 x 1,0	12,0	2,5
290043100	P0601479	M6 x 1,0	14,0	3,0
290043600	P0601679	M6 x 1,0	16,0	3,0
290043300	P0801879	M8 x 1,25	18,0	4,0
290043400	P0802079	M8 x 1,25	20,0	4,0
290043500	P0802579	M8 x 1,25	25,0	4,0

SPARE PARTS

PILOT DRILL

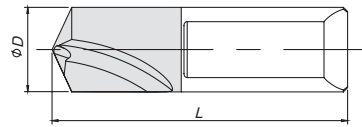

Shank Type

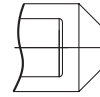

A (with cone)



B (with chamfer)

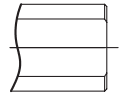

C

Order Code	Reference	Dimensions (mm)		Type	Oil Hole	For Drill
		ØD	L			
184104100	MDP 3006	6	30	B	-	DHS (Ø25 - Ø30)
184104400	MDP 3508	8	35	B	-	DHS (Ø31 - Ø40)
184033100	MDP 3510	10	35	B	✓	DHC (Ø41 - Ø50), MDO (Ø45-Ø55)
184033200	MDP 3812	12	38	B	✓	DHC (Ø51 - Ø75), MDO (Ø55-Ø75)
184033300	MDP 4516	16	45	B	✓	DHC (Ø75 - Ø80), MDO (Ø75-Ø100)
184033400	MDP 4520	20	45	C	✓	MDO (Ø100-Ø120)
184033500	MDP 5625	25	56	C	✓	MDO (Ø120-Ø160)
184033600	MDP 6830	30	68	C	✓	MDO (Ø160-Ø180)
184150900	MDP 2006	6	20	A	-	TFD (Ø18,0 - Ø25,0)
184151000	MDP 2508	8	25	A	-	TFD (Ø25,5 - Ø30,0)

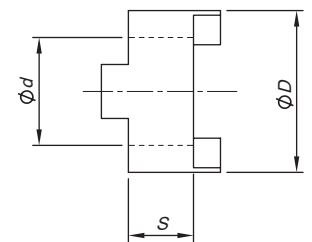

DRIVE RING

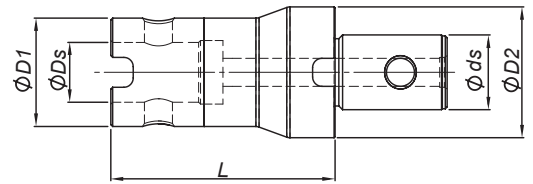
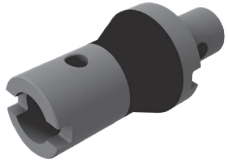

Order Code	Reference	Dimensions (mm) Dimensões (mm) Dimensiones (mm)		
		ØD	Ød	S
184021600	MDR 1028	28	13	10
184021700	MDR 1032	32	16	10
184022100	MDR 1240	40	22	12
184022200	MDR 1248	48	27	12
184022300	MDR 1458	58	32	14
184022400	MDR 1470	70	40	14
184022500	MDR 1680	80	50	16

MDM - REDUCER



Order Code	Reference	Dimensions / Dimensões / Dimensiones (mm)					Drive Ring D1	Drive Ring D2
		ØDs	Øds	ØD1	ØD2	L		
184253900	MDM 16100130	13	16	28	32	100	MDR 1028	MDR 1032
184254000	MDM 22100160	16	22	32	40	100	MDR 1032	MDR 1240
184254100	MDM 27100220	22	27	40	48	100	MDR 1240	MDR 1248
184254200	MDM 32100130	13	32	28	58	100	MDR 1028	MDR 1458
184254300	MDM 32100160	16	32	32	58	100	MDR 1032	MDR 1458
184254400	MDM 32100220	22	32	40	58	100	MDR 1240	MDR 1458
184254500	MDM 32100270	27	32	48	58	100	MDR 1248	MDR 1458
184254600	MDM 40100320	32	40	58	70	100	MDR 1458	MDR 1470
184254700	MDM 50080130	13	50	28	80	80	MDR 1028	MDR 1680
184254800	MDM 50080160	16	50	32	80	80	MDR 1032	MDR 1680
184254900	MDM 50080220	22	50	40	80	80	MDR 1240	MDR 1680
184255000	MDM 50080270	27	50	48	80	80	MDR 1248	MDR 1680
184255100	MDM 50080320	32	50	58	80	80	MDR 1458	MDR 1680
184250200	MDM 50150400	40	50	70	80	150	MDR 1470	MDR 1680

RDS - DRILL SLEEVE

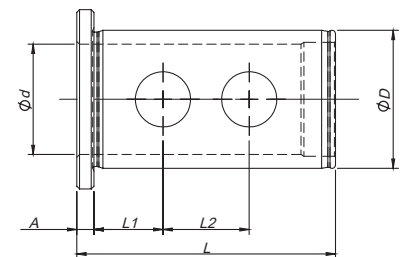

Order Code	Reference	Dimensions / Dimensões / Dimensiones (mm)					
		ØD	Ød	L	L1	L2	A
184258900	RDS 203265	32	20	65	20	-	5
184259000	RDS 253265	32	25	65	20	20	5
184259100	RDS 204075	40	20	75	20	-	5
184259200	RDS 254075	40	25	75	20	25	5
184259300	RDS 324075	40	32	75	20	25	5
184259400	RDS 205095	50	20	95	35	-	5
184259500	RDS 255095	50	25	95	35	-	5
184259600	RDS 325095	50	32	95	35	35	5
184259700	RDS 405095	50	40	95	35	35	5

TECHNICAL DATA | Datos técnicos | Datos técnicos

	1	5	10	15	20	25	30	35	40	45	50		
DRILLING Jet Drills P STEEL			PH6910									PVD	
				PH6920									
				PHU920					NEW				
						PH6930							
						PHC930							
Integrex Drills M STAINLESS STEEL				PH6920									PVD
				PHU920					NEW				
						PH6930							
						PHC930							
Vortex Drills K CAST IRON			PH6910									PVD	
				PH6920									
				PHU920					NEW				
						PH6930							
						PHC930							
Trepanning Drills N ALUMINIUM			PH0910									UNC	

PVD GRADES

PH6910

P05-P10
K05-K10

Coated carbide grade with a very hard substrate for drilling of steels and cast irons.

PH6920

P10-P35
M10-M25
K10-K30

Coated grade over a tough wear resistance substrate for general purpose machining.

PH6930

P20-P40
M20-M30
K20-K40

Grade suitable for applications with instability conditions. Excellent solution for medium cutting speed applications.

PHC930

P20-P40
M20-M30
K20-K40

Grade suitable for applications with instability conditions. Excellent solution for medium cutting speed applications. Coated in Yellow to be visually distinguishable.

Grades recommendation for drilling systems

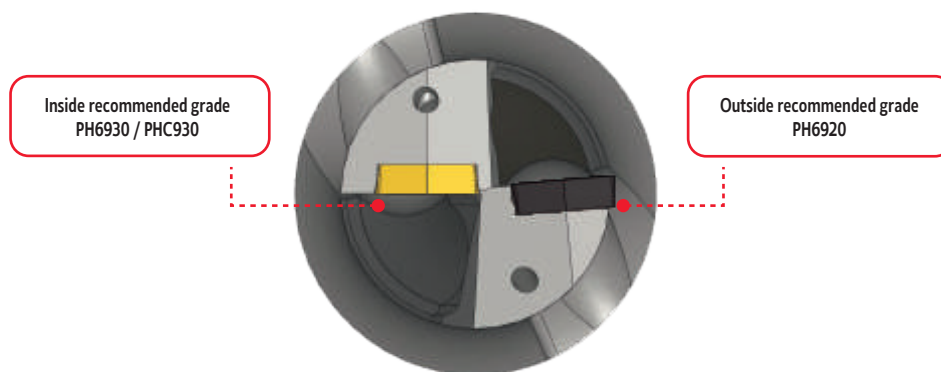

Note: This recommendation should be applied on High Alloy Steels, Stainless Steels and HRSA materials.

PHU920

Combining both excellent thermal resistance and excellent surface quality, the PHU920 grade is recommended for steels, stainless steels and cast iron.

Because of its surface quality and thermal resistance it is able to prevent built-up-edge in both low-alloy steels and stainless steels, making it a very versatile grade.

- High thermal shock resistance
- Carefully engineered surface quality
- Suitable for dry and wet machining
- Color: Grey



JET DRILLS = TDS & TDC DRILL TYPE

Recommended Speeds and Feeds | Parâmetros de Corte Recomendados Recomendaciones de Datos de Corte

ISO	Material Group Grupo Materiais Grupo Materiales	Vc (m/min)	Ø13-15,5	Ø16-20	Ø20,5-25	Ø25,5-30	Ø31-41	Ø42-58	Ø59-80
P	UNALLOYED STEEL (-0,25%)	180-260	0,05-0,08	0,06-0,10	0,07-0,12	0,09-0,15	0,11-0,18	0,15-0,28	0,11-0,18
	LOW-ALLOY STEEL (0,25%-)	150-240	0,05-0,08	0,06-0,10	0,07-0,12	0,09-0,15	0,11-0,18	0,15-0,28	0,11-0,18
	LOW-ALLOY STEEL	120-240	0,05-0,08	0,06-0,10	0,07-0,12	0,09-0,15	0,11-0,18	0,15-0,28	0,11-0,18
	HIGH-ALLOY STEEL	130-220	0,05-0,08	0,06-0,10	0,07-0,12	0,09-0,15	0,11-0,18	0,15-0,28	0,11-0,18
M	STAINLESS STEEL	150-220	0,04-0,08	0,05-0,09	0,06-0,12	0,07-0,13	0,08-0,16	0,10-0,20	0,08-0,16
K	GREY CAST IRON	150-250	0,05-0,11	0,07-0,13	0,08-0,12	0,10-0,18	0,14-0,26	0,18-0,35	0,14-0,26
	CAST IRON WITH NODULAR CAST	120-200	0,05-0,11	0,06-0,13	0,07-0,12	0,08-0,18	0,14-0,26	0,18-0,35	0,14-0,26
N	ALUMINIUM FORGING ALLOYS	180-280	0,04-0,06	0,07-0,12	0,08-0,13	0,09-0,15	0,12-0,20	0,08-0,13	0,09-0,15
	ALUMINIUM CAST ALLOYS	120-270	0,04-0,06	0,06-0,12	0,08-0,13	0,09-0,15	0,12-0,20	0,08-0,13	0,09-0,15

Power Requirements | Requisitos de Potência | Requisitos de Potencia

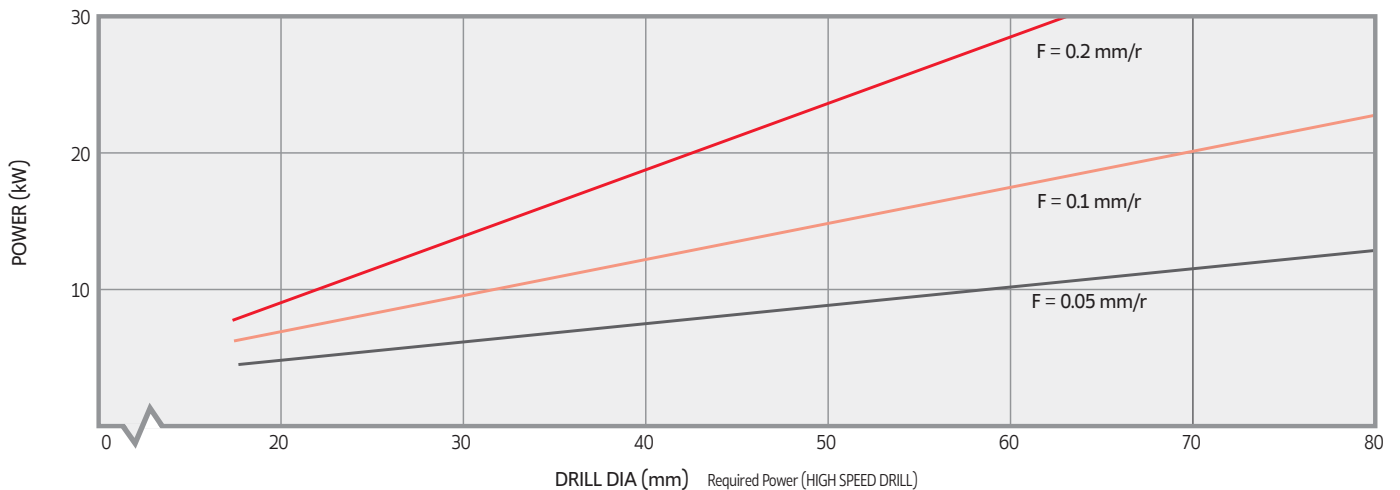

• This chart is based on machining experiences using steels with a hardness of 200-250HB and cutting speed of 100m/min.
• For cast iron the effective power requirement is around 30% lower.

Coolant Application Chart | Tabela Aplicação de Refrigeração | Tabla Aplicación de Refrigerante

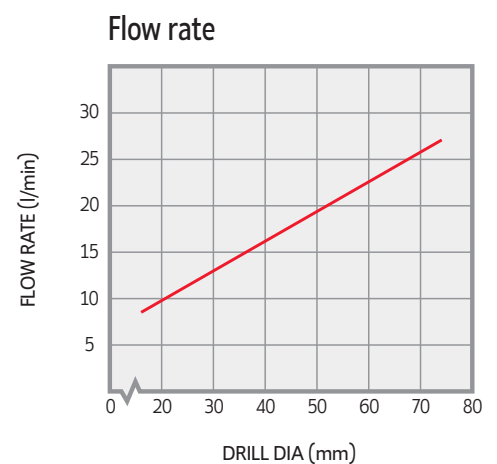
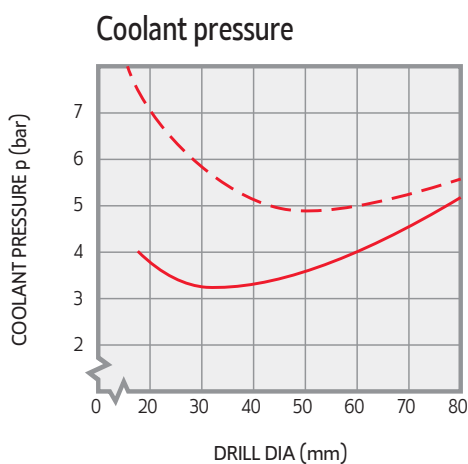

TDS & TDC DRILL TYPE

Hole Tolerance and Maximum Hole Size With Radial Adjustment | Tolerância do Furo e Dimensão Máxima do Furo com Ajuste Radial | Tolerancia de los Agujeros y el Tamaño Del agujero Máximo con Ajuste Radial

Drill D	Radial Adjust	Max Hole D
13.00	1.50	16.00
13.50	1.50	16.50
14.00	1.50	17.00
14.50	1.50	17.50
15.00	1.50	18.00
15.50	1.50	18.50
16.00	1.50	19.00
16.50	1.50	19.50
17.00	1.50	20.00
17.50	1.50	20.50
18.00	1.40	20.80
18.50	1.30	21.10
19.00	1.20	21.40
20.00	1.00	22.00
21.00	1.60	24.20
22.00	1.50	25.00
23.00	1.25	25.50
24.00	1.00	26.00
25.00	0.80	26.60
26.00	2.50	31.00
27.00	2.20	31.40
28.00	2.10	32.20
29.00	1.80	32.60
30.00	1.50	33.00
31.00	3.50	38.00
32.00	3.20	38.40

Drill D	Radial Adjust	Max Hole D
33.00	3.00	39.00
34.00	2.80	39.60
35.00	2.50	40.00
36.00	2.30	40.60
37.00	2.00	41.00
38.00	1.80	41.60
39.00	1.50	42.00
40.00	1.20	42.40
41.00	1.00	43.00
42.00	4.20	50.40
43.00	4.00	51.00
44.00	3.70	51.40
45.00	3.50	52.00
46.00	3.30	52.60
47.00	3.00	53.00
48.00	2.70	53.40
49.00	2.50	54.00
50.00	2.20	54.40
51.00	2.00	55.00
52.00	1.80	55.60
53.00	1.50	56.00
54.00	1.20	56.40
55.00	0.80	56.60
56.00	0.60	57.20
58.00	0.40	58.80

B

DRILLING

Jet Drills

Integrex Drills

Vortex Drills

Trepanning Drills

Solid Carbide Drills

Inserts

Spare Parts

Technical Data

JET DRILLS - TDS & TDC DRILL TYPE

Rules & Tips | Regras e Dicas | Normas e Consejos

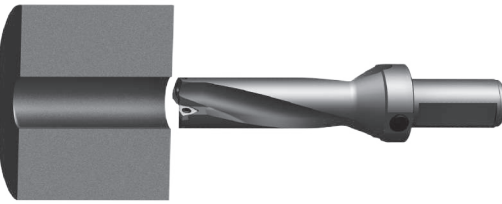
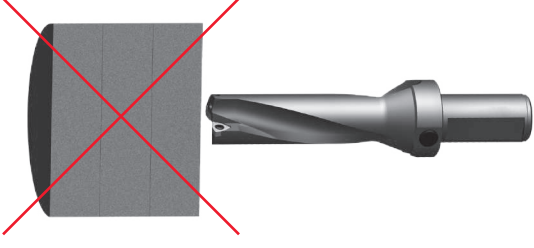
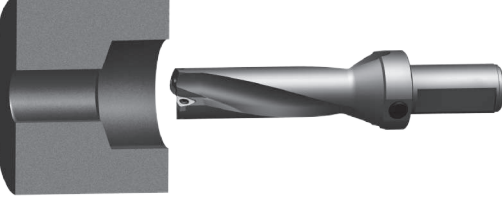
Operation Operação Operación	Description Descrição Descripción
<ul style="list-style-type: none"> • SPOT DRILLING THROUGH ON INCLINED SURFACES • FURAÇÃO LOCALIZADA E FURAÇÃO ATRAVÉS DE SUPERFÍCIES INCLINADAS • PERFORACIÓN LOCALIZADA Y PERFORACION SOBRE SUPERFÍCIES INCLINADAS 	<ul style="list-style-type: none"> • Up to a 30° inclination angle is possible without reducing the cutting parameters. For angles between 30-40°, reduce feed force at incline surface by 50% • Até um ângulo de 30° é possível sem a redução dos parâmetros de corte. Para ângulos entre 30-40°, reduza o avanço na superfície inclinada em 50%. • Hasta un ángulo de inclinación de 30° es posible sin la reducción de los parámetros de corte. En ángulos entre 30-40°, reduzca el avance en 50%.
<ul style="list-style-type: none"> • INTERRUPTED CUTS • CORTE INTERROMPIDO • CORTE INTERRUPTIDO 	<ul style="list-style-type: none"> • For problem-free drilling in interrupted cuts (cross drilling, etc.), reduce the cutting force and feed by 30% to maintain maximum stability of the machine and clamping mechanisms. • Para furação em corte interrompido, reduza a velocidade de corte e o avanço em 30% para manter a estabilidade máxima da máquina e sistemas de aperto. • En perforación en corte interrumpido, reduzca la velocidad de corte e el avance en 30% para mantener la estabilidad.
<ul style="list-style-type: none"> • DRILLING OF STACKED PLATES • FURAÇÃO DE CHAPAS EMPILHADAS • PERFORACIÓN DE PLACAS APILADAS 	<ul style="list-style-type: none"> • This is not possible with the standart TDS or TDC drills. A final disc will form when the drill breaks through. • Esta operação não é possível com as brocas standart TDS ou TDC. Um disco forma-se e poderá saltar no final da operação quando trespassa a peça. • Esta operación no és posible com brocas standart TDS o TDC.
<ul style="list-style-type: none"> • BORING • MADRILAGEM • MANDRILAGEM 	<ul style="list-style-type: none"> • When the TDC or TDS drill are used as boring tool, offset the drill in the direction of the cutter insert. Watch the outer insert for wear because is cutting more metal than the inner insert and may require more frequent indexing. • Quando as TDS ou TDC são usadas para operações de mandrilamento oriente a broca pela pastilha exterior. Observe o desgaste da pastilha exterior uma vez que esta debasta mais metal que a pastilha exterior e poderá requerer uma indexação mais frequente. • Siempre que use las TDS o TDC en operaciones de mandrilage, oriente el inserto exterior. Se deve observar el desgaste del inserto exterior una vez que podrá necessitar de una indexación mas regular.

JET DRILLS - SCS & SCC DRILL TYPE

Recommended Speeds and Feeds | Parâmetros de Corte Recomendados | Recomendaciones de Datos de Corte

ISO	Material Group Grupo Materiais Grupo Materiales	Vc (m/min)	Ø12,5-15	Ø15,5-21,5	Ø22-27,5	Ø28-33	Ø34-41	Ø42-50	Ø50-60	Ø60-75	Ø75-80
P	UNALLOYED STEEL (-0,25%)	180-250	0,05-0,08	0,06-0,10	0,06-0,12	0,07-0,13	0,08-0,15	0,08-0,16	0,06-0,12	0,08-0,12	0,08-0,12
	LOW-ALLOY STEEL (0,25%)	160-220	0,06-0,12	0,08-0,15	0,10-0,18	0,12-0,22	0,12-0,24	0,13-0,25	0,10-0,14	0,12-0,18	0,11-0,18
	LOW-ALLOY STEEL	150-220	0,06-0,12	0,08-0,14	0,10-0,18	0,12-0,22	0,12-0,23	0,13-0,24	0,08-0,15	0,10-0,18	0,10-0,18
	HIGH-ALLOY STEEL	130-180	0,06-0,10	0,08-0,15	0,10-0,20	0,12-0,23	0,12-0,24	0,13-0,25	0,08-0,14	0,09-0,15	0,09-0,14
M	STAINLESS STEEL	170-240	0,05-0,10	0,06-0,12	0,08-0,15	0,09-0,16	0,10-0,17	0,11-0,19	0,06-0,13	0,08-0,15	0,08-0,14
K	GREY CAST IRON	180-250	0,06-0,12	0,08-0,16	0,12-0,20	0,15-0,25	0,16-0,28	0,18-0,30	0,12-0,20	0,15-0,20	0,15-0,20
	CAST IRON WITH NODULAR CAST	130-200	0,06-0,10	0,08-0,15	0,10-0,18	0,12-0,20	0,15-0,23	0,16-0,25	0,10-0,15	0,09-0,18	0,10-0,18

Power Requirements | Requisitos de Potência | Requisitos de Potencia

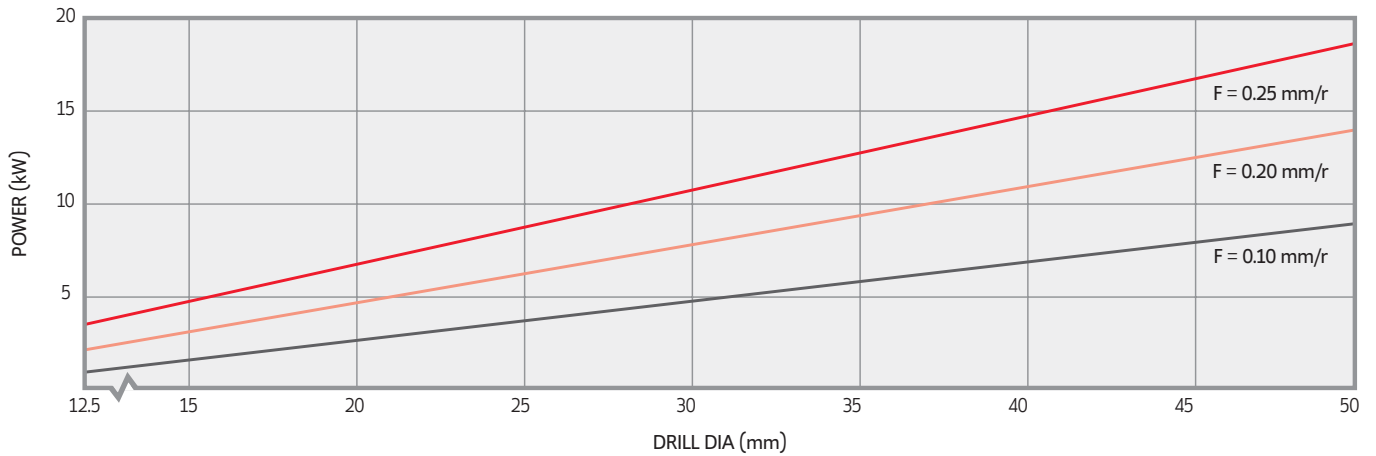

- These chart is based on machining experiences using steels with a hardness of 200-250HB and cutting speed of 100m/min.
- For cast iron the effective power requirement is around 30% lower.

Coolant Application Chart | Tabela Aplicação de Refrigeração | Tabla Aplicación de Refrigerante

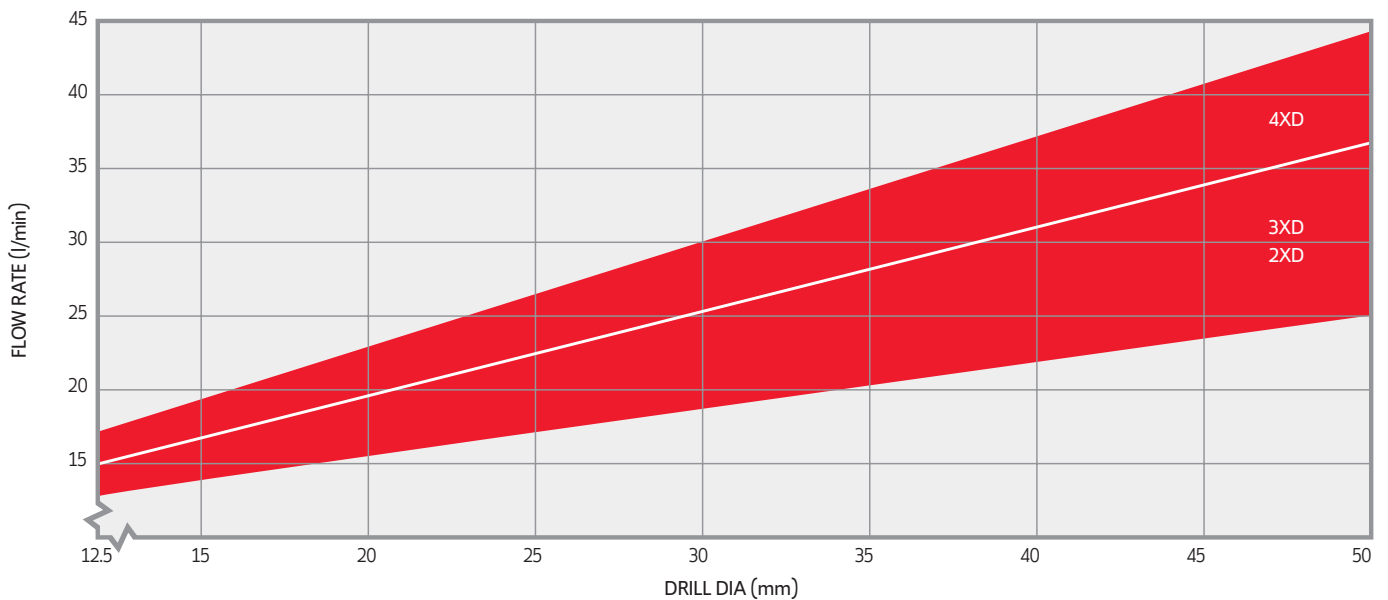



JET DRILLS - SCS DRILL TYPE

Hole Tolerance and Maximum Hole Size With Radial Adjustment
 Tolerância do Furo e Dimensão Máxima do Furo com Ajuste Radial
 Tolerancia de los Agujeros y el Tamaño Del agujero Máximo con Ajuste Radial

Drill D	4xD	
	Radial Adjust	Max. Hole D
13	0.50	14.0
14	0.50	15.0
15	0.50	16.0
16	0.50	17.0
17	0.50	18.0
18	0.50	19.0
19	0.50	20.0
20	0.50	21.0
21	0.25	21.5
22	0.50	23.0
23	0.50	24.0
24	0.50	25.0
25	0.50	26.0
26	0.25	26.5
27	0.25	27.5
28	0.50	29.0
29	0.50	30.0
30	0.50	31.0
31	0.25	31.5
32	0.25	32.5
33	0.25	33.5
34	0.50	35.0
35	0.50	36.0
36	0.50	37.0
37	0.50	38.0
38	0.50	39.0
39	0.50	40.0
40	0.25	40.5
41	0.25	41.5
42	0.50	43.0
43	0.50	44.0
44	0.50	45.0
45	0.50	46.0
46	0.50	47.0
47	0.50	48.0
48	0.25	48.5
49	0.25	49.5
50	0.25	50.5

Drill D	4xD	
	Radial Adjust	Max. Hole D
13	0.50	14.0
14	0.50	15.0
15	0.50	16.0
16	0.50	17.0
17	0.50	18.0
18	0.50	19.0
19	0.50	20.0
20	0.50	21.0
21	0.25	21.5
22	0.50	23.0
23	0.50	24.0
24	0.50	25.0
25	0.50	26.0
26	0.25	26.5
27	0.25	27.5
28	0.50	29.0
29	0.50	30.0
30	0.50	31.0
31	0.25	31.5
32	0.25	32.5
33	0.25	33.5
34	0.50	35.0
35	0.50	36.0
36	0.50	37.0
37	0.50	38.0
38	0.50	39.0
39	0.50	40.0
40	0.25	40.5
41	0.25	41.5
42	0.50	43.0
43	0.50	44.0
44	0.50	45.0
45	0.50	46.0
46	0.50	47.0
47	0.50	48.0
48	0.25	48.5
49	0.25	49.5
50	0.25	50.5

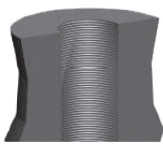
Problem Problema	Corrective Action	Possível Solução	Solución Posible
<p>INNER CUTTING EDGE CRACKING</p> 	<p>On Lathes:</p> <ul style="list-style-type: none"> • Check machine alignment. • Check clamping accuracy. If tool clamping cannot be improved and/or optimum machine stability is doubtful, reduce feed by 30%. • User tougher carbide grade. <p>TIP: Grades can be mixed to achieve optimum performance.</p> <p>Example: Use grade PH6125 in the inside pocket with PH6135 in the outside pocket.</p>	<p>Em Tornos:</p> <ul style="list-style-type: none"> • Verifique o alinhamento máquina. • Verifique a precisão do aperto. Se o aperto não puder ser melhorado e/ou a otimização da estabilidade da máquina é duvidosa, reduza o avanço em 30%. • Usar classes de graus mais duras. <p>DICA: Misture classes Graus para alcançar o desempenho ideal.</p> <p>Exemplo: Utilize PH6125 na pastilha interior e PH6135 na pastilha exterior.</p>	<p>Tornos en:</p> <ul style="list-style-type: none"> • Compruebe la alineación de máquinas. • Verificar la precisión de sujeción. Si la herramienta de sujeción no puede mejorar y/o optimizar la estabilidad de la máquina es dudosa, reducir los piensos en un 30%. • El usuario de carburo de calidad es más estrictas. <p>SUGERENCIA: Las calificaciones se pueden mezclar para lograr un rendimiento óptimo.</p> <p>Ejemplo: Utilice PH6125 en el inserto interior e PH6135 en el inserto exterior.</p>
<p>CHIP EVACUATION NOT OPTIMAL</p> 	<ul style="list-style-type: none"> • Increase coolant pressure and volume (coolant helps support chip evacuation as well as cooling the cutting edges). • Optimize chip control for a given application. • Increase cutting speed by 20%. 	<ul style="list-style-type: none"> • Aumente a pressão e volume do líquido de refrigeração (este permite uma melhor evacuação da apar, bem como um arrefecimento das arestas de corte). • Optimize o controlo das aparas para cada operação. • Aumentar a velocidade de corte de 20%. 	<ul style="list-style-type: none"> • Aumentar la presión del refrigerante y el volumen (el líquido de refrigeración de chips de apoyo ayuda a la evacuación, así como el enfriamiento de la corte de los bordes). • Optimizar el control de chip para una aplicación determinada. • Aumentar la velocidad de corte un 20%.
<p>EXCESSIVE INSERT WEAR</p> 	<ul style="list-style-type: none"> • Increase coolant pressure and volume. • Reduce cutting speed by 20%. • Use a more wear – resistant grade. 	<ul style="list-style-type: none"> • Aumente o volume e a pressão do líquido de refrigeração. • Reduzir a velocidade de corte de 20%. • Utilize um grau mais resistente ao desgaste. 	<ul style="list-style-type: none"> • Aumentar la presión del refrigerante y el volumen. • Reducir la velocidad de corte en un 20%. • Utilice un mayor desgaste - resistente grado.
<p>POOR DRILL HOLE QUALITY</p> 	<ul style="list-style-type: none"> • Increase coolant pressure and volume. • Increase cutting speed by 20% • Check clamping accuracy (tool and workpiece) for possible improvement. <p>TIP: Use higher speed with lighter feed to produce better hole quality.</p>	<ul style="list-style-type: none"> • Aumente o volume e a pressão do líquido de refrigeração. • Aumentar a velocidade de cortede 20% • Verifique a precisão do aperto (ferramenta e peça). <p>DICA: Utilize velocidades com avanços menores para produzir uma melhor qualidade do furo.</p>	<ul style="list-style-type: none"> • Aumentar la presión del refrigerante y el volumen. • Aumentar la velocidad de corte en un 20% • Verificar la precisión de sujeción(herramienta y pieza de trabajo) para una posible mejora. <p>SUGERENCIA: El uso ligero con mayor velocidad de alimentación para producir una mejor calidad agujero.</p>

Initial Drill Set Up and Check | Ajuste Inicial da Broca e Verificação | Ajuste Inicial de la Broca e su Verificación

DRILLING
Jet Drills
Integrex Drills
Vortex Drills
Trepanning Drills
Solid Carbide Drills
Inserts
Spare Parts
Technical Data

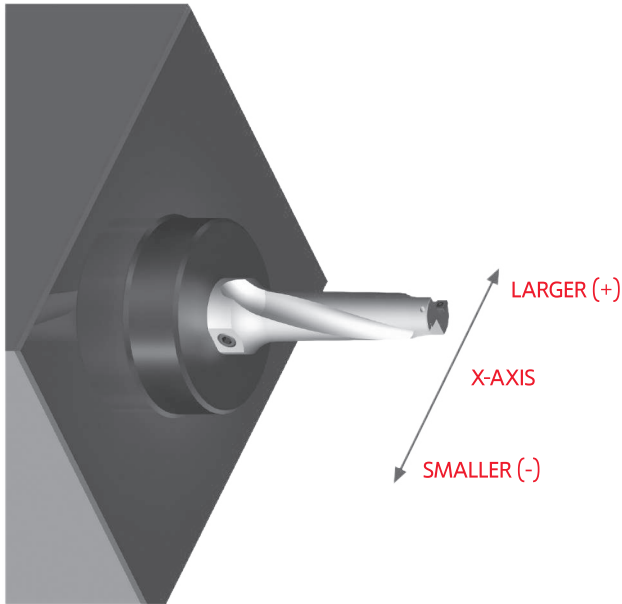

- The cutting edge of insert should be parallel to X-axis to make it possible to do offset cutting. Since a flat part on shank for side lock clamping has been made parallel with the cutting edge line of insert, operator can set the drill as per flat part of shank.

- A aresta de corte da pastilha deve ser paralela ao eixo X tornando possível o alinhamento de corte.

- El hilo de corte del inserto se debe posicionar paralelamente al axis-X tornando posible el aliñamiento de corte.

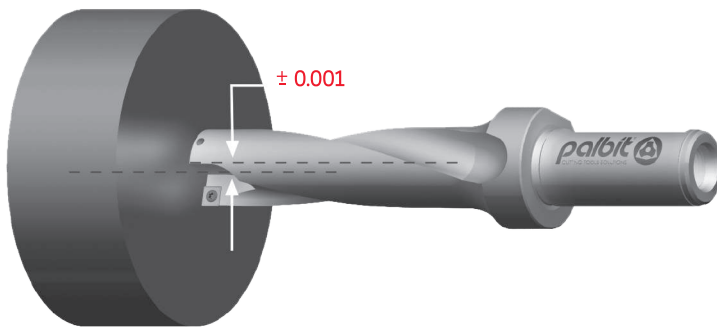
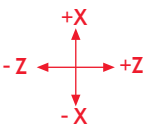

- The outer insert should be located in the direction (+) of X-axis to allow offset cutting and then the inner insert should face the operator.

- A pastilha exterior deve estar localizada na direcção (+) do eixo-X, permitindo assim o alinhamento do corte, a pastilha interior deve estar virada ao operador.

- El inserto exterior se debe localizar en la dirección (+) del axis-X, permitiendo el aliñamiento del corte, el inserto interior debe quedar-se virado para el operador.

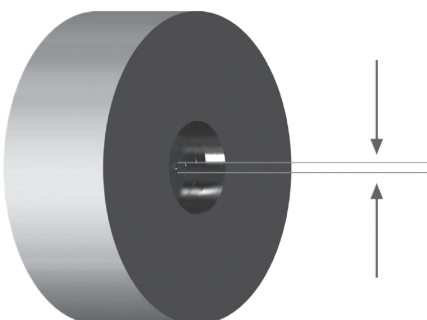

- To check up the setting of drill before use, test it by drilling about 5mm depth and then measure the core size if it is around 0,2mm - 0,7mm.

- Para verificar o ajuste faça o teste furando cerca de 5mm de profundidade medindo depois o núcleo verificando se este tem aproximadamente 0,2 a 0,7mm.

- Para comprobar el ajuste hacer un taladro de cerca de 5 mm de profundidad, medido después su núcleo si se trata de 0,2 a 0,7 mm.

INTEGREX DRILLS - DHS, DHC, TFD DRILL TYPE

Pilot Drill Adjustment | Ajuste da Broca Piloto | Ajuste de la Broca Piloto

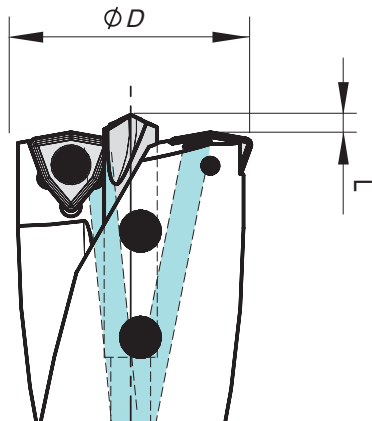

$\varnothing D$	L
18-24	2,5
25-30	3,0
31-39	4,0
40-59	4,5
60-80	5,0

Recommended Speeds and Feeds | Parâmetros de Corte Recomendados Recomendaciones de Datos de Corte



ISO	Material Group Grupo Materiais Grupo Materiales	Vc (m/min)	$\varnothing 25$	$\varnothing 26-30$	$\varnothing 31-40$	$\varnothing 41-50$	$\varnothing 51-59$	$\varnothing 60-75$	$\varnothing 75-80$
P	UNALLOYED STEEL (-0,25%)	130-190	0,06-0,10	0,07-0,11	0,08-0,12	0,10-0,14	0,14-0,20	0,08-0,12	0,10-0,14
	LOW-ALLOY STEEL (0,25%-)	130-190	0,06-0,10	0,07-0,11	0,08-0,12	0,10-0,14	0,12-0,18	0,08-0,12	0,10-0,14
	LOW-ALLOY STEEL (-HB300)	100-140	0,06-0,10	0,07-0,11	0,08-0,12	0,10-0,14	0,12-0,18	0,08-0,12	0,10-0,14
	HIGH-ALLOY STEEL (HB300-)	60-100	0,05-0,07	0,05-0,07	0,06-0,08	0,06-0,10	0,09-0,13	0,06-0,08	0,06-0,10
M	STAINLESS STEEL	60-110	0,04-0,07	0,04-0,11	0,06-0,12	0,08-0,14	0,10-0,18	0,06-0,12	0,08-0,14
K	GREY CAST IRON	130-190	0,07-0,13	0,07-0,15	0,08-0,16	0,10-0,18	0,12-0,22	0,08-0,16	0,10-0,18
	CAST IRON WITH NODULAR CAST	110-190	0,04-0,13	0,07-0,15	0,08-0,16	0,10-0,25	0,12-0,26	0,08-0,16	0,10-0,25

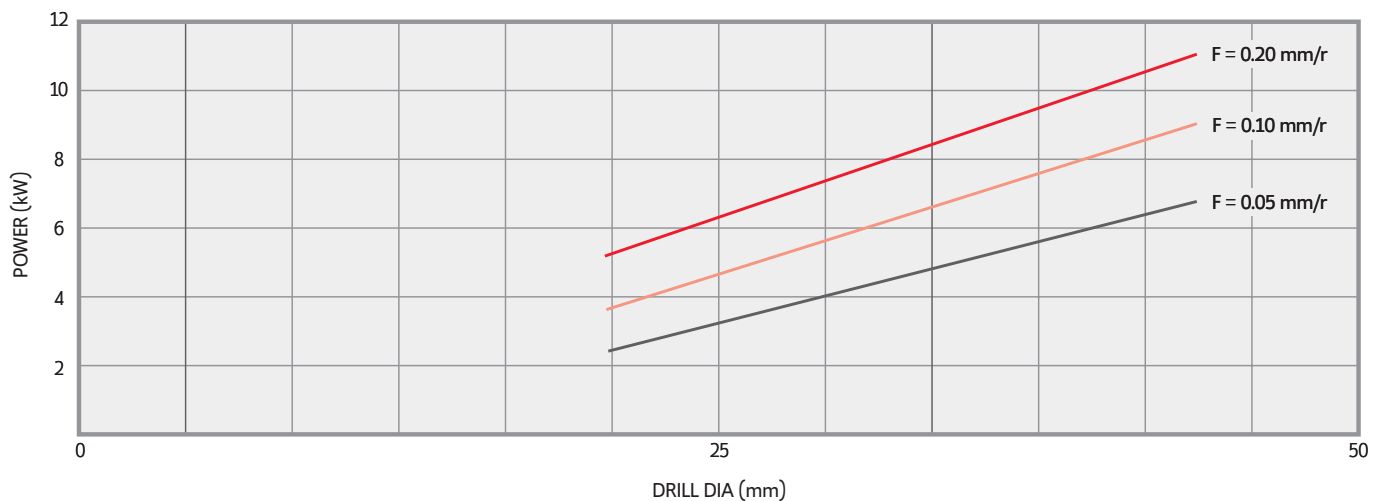



Power Requirements | Requisitos de Potência | Requisitos de Potencia

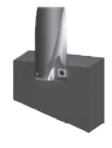
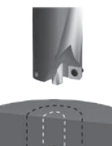

INTEGREX DRILLS - DHS, DHC, TFD DRILL TYPE

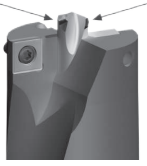
Rules & Tips | Regras e Dicas | Normas e Consejos

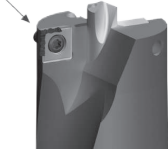
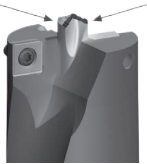
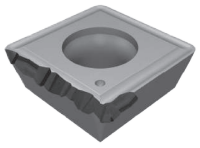
	WRONG	CORRECT	EN	PT	ES
DRILLING			<p>Spot Drilling</p> <p>For plain/straight surfaces, no spot drilling is required. For centering, the center drill diameter should be considerably smaller than the pilot drill diameter.</p>	<p>Furação Localizada</p> <p>Para superfícies planas a furação localizada não é necessária. O diâmetro da broca de pré-furação deve ser consideravelmente menor do que o diâmetro da broca-piloto.</p>	<p>Perforación Localizada</p> <p>Para superficies planas, no se requiere la perforación in situ. Para centrar el diámetro de pré-perforación debe ser considerablemente más pequeño que el diámetro de la broca piloto.</p>
Jet Drills			<p>Spot drilling and drilling through on inclined surfaces.</p> <p>Up to an 8° inclination angle is possible. Drilling through at a maximum of 4° is possible; otherwise, a pre-facing operation is necessary.</p>	<p>Furação localizada e furação através de superfícies inclinadas.</p> <p>Até 8° ângulo de inclinação é possível. Furação até a um máximo de 4° é possível, caso contrário, é necessária uma pré-operação.</p>	<p>Perforación localizada y perforación sobre superficies inclinadas.</p> <p>Hasta un ángulo de inclinación de 8° es posible. A través de la perforación en un máximo de 4° es posible, de otro modo, es necesaria pre-operación.</p>
Integrex Drills			<p>Multi-Stage Drill Hole</p> <p>Integrex series drills are not recommended for boring operations. First, use the Integrex drill to drill a larger diameter hole. Then, use a solid carbide drill for smaller holes. Optimum centering of the solid carbide drill is possible on the drill hole of the pilot drill.</p>	<p>Furo Multi-Estágio</p> <p>As brocas Integrex não são recomendadas para operações de mandrilagem. Primeiro utilize a Integrex para o furo de diâmetro maior, então use uma broca Metal Duro Integrex para o furo de diâmetro mais reduzido.</p>	<p>Multi-etapa taladro</p> <p>Las brocas Integrex no son recomendadas para las operaciones de mandrilagen. En primer lugar, utilizar la Integrex para perforar un agujero de diámetro mayor. A continuación, utilice una broca de carburo sólido para los pequeños agujeros. Centrado óptimo del taladro de carburo sólido es posible en el taladro de la broca piloto.</p>
Vortex Drills			<p>Multi-Stage Drill Hole</p> <p>Integrex series drills are not recommended for boring operations. First, use the Integrex drill to drill a larger diameter hole. Then, use a solid carbide drill for smaller holes. Optimum centering of the solid carbide drill is possible on the drill hole of the pilot drill.</p>	<p>Furo Multi-Estágio</p> <p>As brocas Integrex não são recomendadas para operações de mandrilagem. Primeiro utilize a Integrex para o furo de diâmetro maior, então use uma broca Metal Duro Integrex para o furo de diâmetro mais reduzido.</p>	<p>Multi-etapa taladro</p> <p>Las brocas Integrex no son recomendadas para las operaciones de mandrilagen. En primer lugar, utilizar la Integrex para perforar un agujero de diámetro mayor. A continuación, utilice una broca de carburo sólido para los pequeños agujeros. Centrado óptimo del taladro de carburo sólido es posible en el taladro de la broca piloto.</p>
Trepanning Drills			<p>Multi-Stage Drill Hole</p> <p>Integrex series drills are not recommended for boring operations. First, use the Integrex drill to drill a larger diameter hole. Then, use a solid carbide drill for smaller holes. Optimum centering of the solid carbide drill is possible on the drill hole of the pilot drill.</p>	<p>Furo Multi-Estágio</p> <p>As brocas Integrex não são recomendadas para operações de mandrilagem. Primeiro utilize a Integrex para o furo de diâmetro maior, então use uma broca Metal Duro Integrex para o furo de diâmetro mais reduzido.</p>	<p>Multi-etapa taladro</p> <p>Las brocas Integrex no son recomendadas para las operaciones de mandrilagen. En primer lugar, utilizar la Integrex para perforar un agujero de diámetro mayor. A continuación, utilice una broca de carburo sólido para los pequeños agujeros. Centrado óptimo del taladro de carburo sólido es posible en el taladro de la broca piloto.</p>
Solid Carbide Drills			<p>Drilling of stacked plates</p> <p>This is not possible with Integrex series drills because a final disc forms when the drill breaks through.</p> <p>Caution: During through-hole operations, a slug or disc is produced as the tool breaks through the workpiece. When the drill is stationary and the workpiece is rotating, this slug may be hurled from the chuck by centrifugal force. Provide adequate shielding to protect all bystanders.</p>	<p>Furação de chapas empilhadas</p> <p>Isso não é possível com a Integrex porque um disco final forma-se quando a broca passa</p> <p>Cuidado: Durante operações de trespassar uma placa, uma apara ou disco é produzido quando a broca rompe através da peça. Quando a broca está parada e é a peça rotativa, este disco pode ser arremessado da brecha pela força centrífuga. Proporcionar adequada blindagem para proteger todos os transeuntes.</p>	<p>Perforación de placas apiladas</p> <p>Esto no es posible con la Integrex debido a un disco que se forma cuando el taladro a través de las placas.</p> <p>Precaución: Durante las operaciones a través de agujeros, una babosa o disco se produce como la herramienta provocando saltos de la pieza. Cuando la perforación es estacionaria y la pieza está girando, este disco puede ser lanzado desde el plato por la fuerza centrífuga. Proporcionar la protección adecuada para proteger a todos los transeúntes.</p>
Inserts			<p>Drilling of stacked plates</p> <p>This is not possible with Integrex series drills because a final disc forms when the drill breaks through.</p> <p>Caution: During through-hole operations, a slug or disc is produced as the tool breaks through the workpiece. When the drill is stationary and the workpiece is rotating, this slug may be hurled from the chuck by centrifugal force. Provide adequate shielding to protect all bystanders.</p>	<p>Furação de chapas empilhadas</p> <p>Isso não é possível com a Integrex porque um disco final forma-se quando a broca passa</p> <p>Cuidado: Durante operações de trespassar uma placa, uma apara ou disco é produzido quando a broca rompe através da peça. Quando a broca está parada e é a peça rotativa, este disco pode ser arremessado da brecha pela força centrífuga. Proporcionar adequada blindagem para proteger todos os transeuntes.</p>	<p>Perforación de placas apiladas</p> <p>Esto no es posible con la Integrex debido a un disco que se forma cuando el taladro a través de las placas.</p> <p>Precaución: Durante las operaciones a través de agujeros, una babosa o disco se produce como la herramienta provocando saltos de la pieza. Cuando la perforación es estacionaria y la pieza está girando, este disco puede ser lanzado desde el plato por la fuerza centrífuga. Proporcionar la protección adecuada para proteger a todos los transeúntes.</p>
Spare Parts			<p>Drilling of stacked plates</p> <p>This is not possible with Integrex series drills because a final disc forms when the drill breaks through.</p> <p>Caution: During through-hole operations, a slug or disc is produced as the tool breaks through the workpiece. When the drill is stationary and the workpiece is rotating, this slug may be hurled from the chuck by centrifugal force. Provide adequate shielding to protect all bystanders.</p>	<p>Furação de chapas empilhadas</p> <p>Isso não é possível com a Integrex porque um disco final forma-se quando a broca passa</p> <p>Cuidado: Durante operações de trespassar uma placa, uma apara ou disco é produzido quando a broca rompe através da peça. Quando a broca está parada e é a peça rotativa, este disco pode ser arremessado da brecha pela força centrífuga. Proporcionar adequada blindagem para proteger todos os transeuntes.</p>	<p>Perforación de placas apiladas</p> <p>Esto no es posible con la Integrex debido a un disco que se forma cuando el taladro a través de las placas.</p> <p>Precaución: Durante las operaciones a través de agujeros, una babosa o disco se produce como la herramienta provocando saltos de la pieza. Cuando la perforación es estacionaria y la pieza está girando, este disco puede ser lanzado desde el plato por la fuerza centrífuga. Proporcionar la protección adecuada para proteger a todos los transeúntes.</p>
Technical Data			<p>Drilling of stacked plates</p> <p>This is not possible with Integrex series drills because a final disc forms when the drill breaks through.</p> <p>Caution: During through-hole operations, a slug or disc is produced as the tool breaks through the workpiece. When the drill is stationary and the workpiece is rotating, this slug may be hurled from the chuck by centrifugal force. Provide adequate shielding to protect all bystanders.</p>	<p>Furação de chapas empilhadas</p> <p>Isso não é possível com a Integrex porque um disco final forma-se quando a broca passa</p> <p>Cuidado: Durante operações de trespassar uma placa, uma apara ou disco é produzido quando a broca rompe através da peça. Quando a broca está parada e é a peça rotativa, este disco pode ser arremessado da brecha pela força centrífuga. Proporcionar adequada blindagem para proteger todos os transeuntes.</p>	<p>Perforación de placas apiladas</p> <p>Esto no es posible con la Integrex debido a un disco que se forma cuando el taladro a través de las placas.</p> <p>Precaución: Durante las operaciones a través de agujeros, una babosa o disco se produce como la herramienta provocando saltos de la pieza. Cuando la perforación es estacionaria y la pieza está girando, este disco puede ser lanzado desde el plato por la fuerza centrífuga. Proporcionar la protección adecuada para proteger a todos los transeúntes.</p>

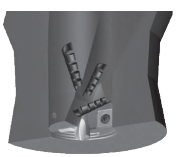
Problem Problema	Corrective Action	Possível Solução	Solución Posible
PILOT DRILL CRACKING 	On Lathes: <ul style="list-style-type: none"> • Verify that the tool is centered correctly. Readjust machine, if necessary. • Check clamping accuracy (tool and workpiece). 	Em Tornos: <ul style="list-style-type: none"> • Verifique se a ferramenta está centrada correctamente. Reajustar a máquina caso necessário. • Verifique a precisão do aperto (ferramento e peça). 	Tornos en: <ul style="list-style-type: none"> • Compruebe que la herramienta se centra correctamente. Reajustar la máquina, si es necesario. • Verificar la precisión de sujeción (herramienta y pieza de trabajo) para una posible mejora.
INNER INSERT CRACKING 	<ul style="list-style-type: none"> • Use tougher carbide grade. • Reduce feed by 20%. • Check clamping accuracy (tool and workpiece) for possible improvement. 	<ul style="list-style-type: none"> • Use classes de graus mais duras. • Reduza o avanço em 20%. • Verifique a precisão do aperto (ferramento e peça). 	<ul style="list-style-type: none"> • Uso más duras de carburo de grado. • Reducción de los piensos en un 20%. • Verificar la precisión de sujeción (herramienta y pieza de trabajo) para una posible mejora.
OUTER INSERT CRACKING 	<ul style="list-style-type: none"> • Use tougher carbide grade and / or stronger insert geometry. • Reduce feed by 20% • When drilling through, reduce feed by 50%. • Check clamping accuracy (tool and workpiece) for possible improvement. 	<ul style="list-style-type: none"> • Use classes de graus mais duras. • Reduza o avanço em 20%. • Verifique a precisão do aperto (ferramento e peça). 	<ul style="list-style-type: none"> • Uso más duras de carburo de grado. • Reducción de los piensos en un 20%. • Verificar la precisión de sujeción (herramienta y pieza de trabajo) para una posible mejora.
EXTENSIVE PILOT DRILL WEAR 	<ul style="list-style-type: none"> • Use coated carbide pilot drill. • Increase coolant pressure and volume. • Reduce cutting speed by 20%. 	<ul style="list-style-type: none"> • Utilize uma broca piloto revestida. • Aumente a pressão e o volume do líquido de refrigeração. • Reduzir a velocidade de corte em 20%. 	<ul style="list-style-type: none"> • Utilice broca piloto revestida. • Aumentar la presión del refrigerante y el volumen. • Reducir la velocidad de corte en un 20%.
EXCESSIVE INSERT WEAR 	On Lathes: <ul style="list-style-type: none"> • Use a more wear-resistant carbide grade. • Increase coolant pressure and volume. • Reduce cutting speed by 20%. 	Em Tornos: <ul style="list-style-type: none"> • Utilize um grau mais resistente ao desgaste. • Aumente a pressão e o volume do líquido de refrigeração. • Reduza a velocidade de corte em 20%. 	Tornos en: <ul style="list-style-type: none"> • Utilice un más resistentes al desgaste de carburo de grado. • Aumentar la presión del refrigerante y el volumen. • Reducir la velocidad de corte en un 20%
CHIP BREAKING NOT OPTIMAL 	<ul style="list-style-type: none"> • Optimize chip control for given application. • Increase cutting speed by 20%, reduce feed by 20%. 	<ul style="list-style-type: none"> • Optimizar a evacuação da aparta para cada operação. • Aumentar a velocidade de corte em 20% e reduzir o avanço em 20%. 	<ul style="list-style-type: none"> • Optimizar el control de chip aplicación dada. • Aumentar la velocidad de corte en un 20%, reducir la alimentación en un 20%.
CHIP EVACUATION NOT OPTIMAL, POOR DRILL HOLE QUALITY 	<ul style="list-style-type: none"> • Increase coolant pressure and volume. • Increase cutting speed by 20%. 	<ul style="list-style-type: none"> • Aumentar o volume e a pressão do líquido de refrigeração. • Aumentar a velocidade de corte em 20%. 	<ul style="list-style-type: none"> • Aumentar la presión del refrigerante y el volumen. • Aumentar la velocidad de corte en un 20%.

VORTEX DRILLS - CUTTING PARAMETERS AND ADJUSTMENTS

QR

DRILLING

Jet Drills

Integrex Drills

Vortex Drills

Trepanning Drills

Solid Carbide Drills

Inserts

Spare Parts

Technical Data

Pilot Drill Adjustment | Ajuste da Broca Piloto | Ajuste de la Broca Piloto

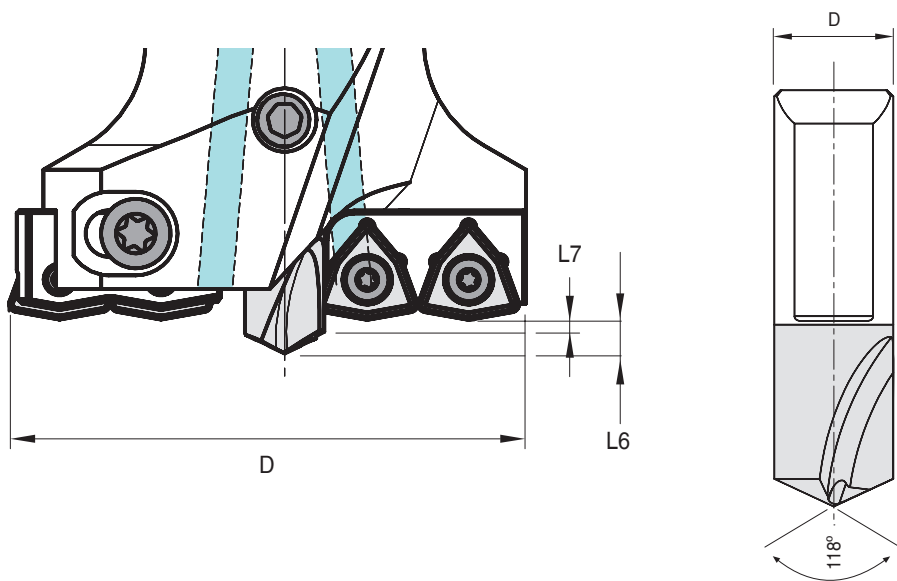

Dc (mm)	2D to 4D		4D to 6D		> 6D	
	L7	L6	L7	L6	L7	L6
45-55	1,6	4,0	1,8	4,2	2,0	4,4
55-75	1,8	5,4	2,0	5,6	2,2	5,8
75-100	2,2	6,5	2,5	6,8	2,8	7,1
100-120	2,4	7,7	2,8	8,1	3,2	8,5
120-170	3,2	9,9	3,6	10,3	4,0	10,7
170-180	3,5	12,2	3,9	12,6	4,3	13,0

Recommended Speeds and Feeds | Parâmetros de Corte Recomendados
 Recomendaciones de Datos de Corte

ISO	Material Group Grupo Materiais Grupo Materiales	Vc (m/min)	Ø45-55	Ø55-60	Ø60-75	Ø75-100	Ø100-105	Ø105-150	Ø150-180
P	UNALLOYED STEEL (-0,25%)	120-180	0,06-0,10	0,07-0,11	0,08-0,12	0,10-0,14	0,14-0,20	0,08-0,12	0,10-0,14
	LOW-ALLOY STEEL (0,25%-)	110-170	0,06-0,10	0,07-0,11	0,08-0,12	0,10-0,14	0,12-0,18	0,08-0,12	0,10-0,14
	LOW-ALLOY STEEL (-HB300)	90-130	0,06-0,10	0,07-0,11	0,08-0,12	0,10-0,14	0,12-0,18	0,08-0,12	0,10-0,14
	HIGH-ALLOY STEEL (HB300-)	60-100	0,05-0,07	0,05-0,07	0,06-0,08	0,06-0,10	0,09-0,13	0,06-0,08	0,06-0,10
M	STAINLESS STEEL	60-110	0,04-0,07	0,04-0,11	0,06-0,12	0,08-0,14	0,10-0,18	0,06-0,12	0,08-0,14
K	GREY CAST IRON	120-180	0,07-0,13	0,07-0,15	0,08-0,16	0,10-0,18	0,12-0,22	0,08-0,16	0,10-0,18
	CAST IRON WITH NODULAR CAST	100-180	0,04-0,13	0,07-0,15	0,08-0,16	0,10-0,25	0,12-0,26	0,08-0,16	0,10-0,25

Power Requirements | Requisitos de Potência | Requisitos de Potencia

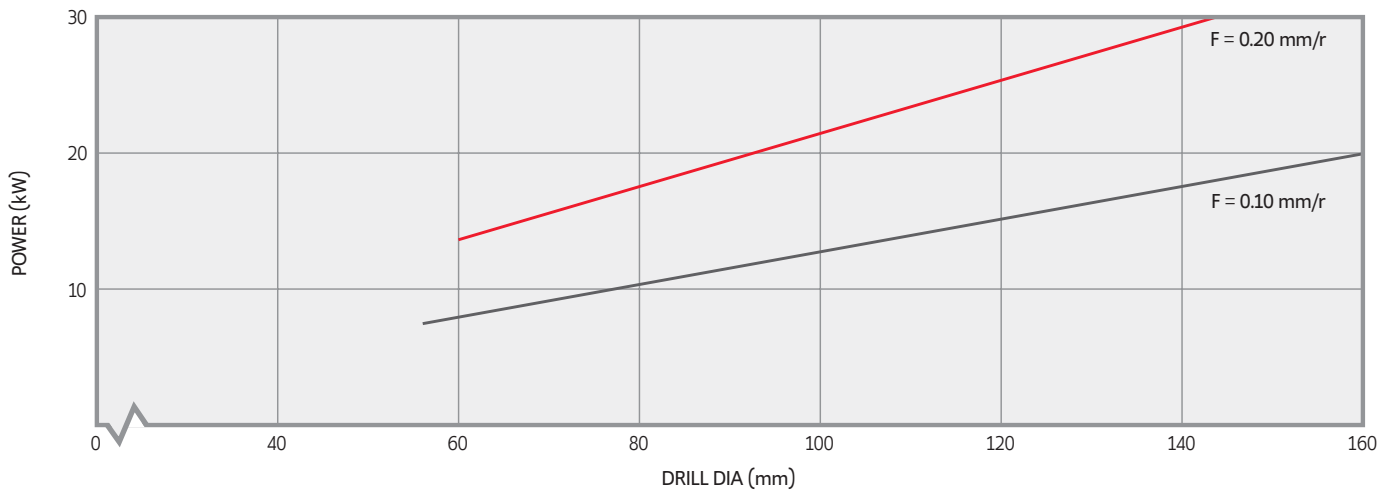

* These chart is based on machining experiences using steels with a hardness of 200-250HB and cutting speed of 100m/min.



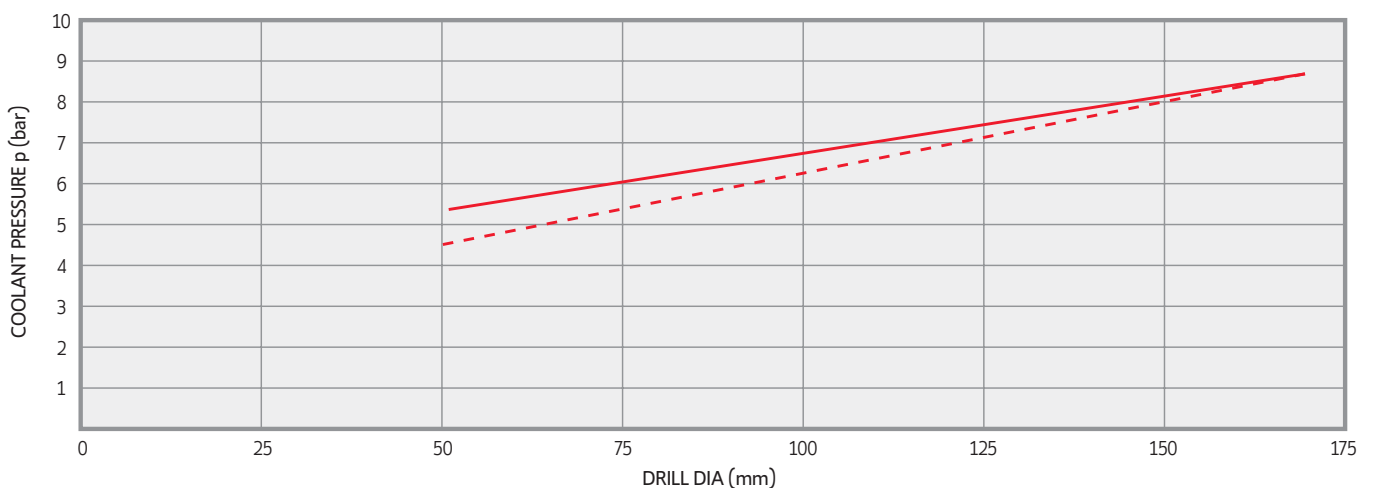





Coolant Application Chart | Tabela Aplicação de Refrigeração | Tabla Aplicación de Refrigerante



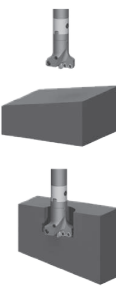

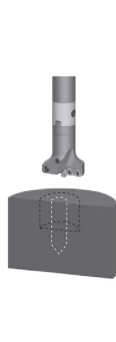
VORTEX DRILLS - CUTTING PARAMETERS AND ADJUSTMENTS

Parâmetros de corte e ajustes | Condiciones de corte y ajustes

Rules & Tips | Regras e Dicas | Normas e Consejos

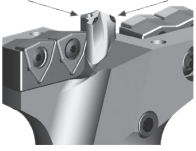
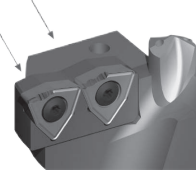
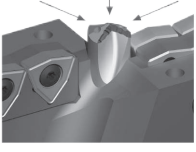
	WRONG	CORRECT	EN	PT	ES
DRILLING			<p>Spot Drilling</p> <p>For plain/straight surfaces, no spot drilling is required. For centering, the center drill diameter should be considerably smaller than the pilot drill diameter.</p>	<p>Furação Localizada</p> <p>Para superfícies planas a furação localizada não é necessária. O diâmetro da broca de pré-furação deve ser consideravelmente menor do que o diâmetro da broca-piloto.</p>	<p>Perforación Localizada</p> <p>Para superficies planas, no se requiere la perforación in situ. Para centrar el diámetro de pré-perforación debe ser considerablemente más pequeño que el diámetro de la broca piloto.</p>
Jet Drills			<p>Spot drilling and drilling through on inclined surfaces.</p> <p>Up to an 8° inclination angle is possible. Drilling through at a maximum of 4° is possible; otherwise, a pre-facing operation is required.</p>	<p>Furação localizada e furação através de superfícies inclinadas.</p> <p>Até 8° ângulo de inclinação é possível. Furação até a um máximo de 4° é possível, caso contrário, é necessária uma pré-operação.</p>	<p>Perforación localizada y perforación sobre superficies inclinadas.</p> <p>Hasta un ángulo de inclinación de 8° es posible. A través de la perforación en un máximo de 4° es posible, de otro modo, es necesaria pre-operación.</p>
Integrex Drills			<p>Multi-Stage Drill Hole</p> <p>Vortex series drills are not recommended for boring operations. First, use the Integrex drill to drill a larger diameter hole. Then, use a solid carbide drill for smaller holes. Optimum centering of the solid carbide drill is possible on the drill hole of the pilot drill.</p>	<p>Furo Multi-Estágio</p> <p>As brocas Vortex não são recomendadas para operações de mandrilagem. Primeiro utilize a Integrex para o furo de diâmetro maior, então use uma broca Metal Duro Integrex para o furo de diâmetro mais reduzido.</p>	<p>Multi-etapa taladro</p> <p>Las brocas Vortex no son recomendadas para las operaciones de mandrilagen. En primer lugar, utilizar la Integrex para perforar un agujero de diámetro mayor. A continuación, utilice una broca de carburo sólido para los pequeños agujeros. Centrado óptimo del taladro de carburo sólido es posible en el taladro de la broca piloto.</p>
Vortex Drills			<p>Drilling of stacked plates</p> <p>This is not possible with Integrex series drills because a final disc forms when the drill breaks through.</p> <p>Caution: During through-hole operations, a slug or disc is produced as the tool breaks through the workpiece. When the drill is stationary and the workpiece is rotating, this slug may be hurled from the chuck by centrifugal force. Provide adequate shielding to protect all bystanders.</p>	<p>Furação de chapas empilhadas</p> <p>Isso não é possível com a Integrex porque um disco final forma-se quando a broca passa</p> <p>Cuidado: Durante operações de trespassar uma placa, uma apara ou disco é produzido quando a broca rompe através da peça. Quando a broca está parada e é a peça rotativa, este disco pode ser arremessado da brecha pela força centrífuga. Proporcionar adequada blindagem para proteger todos os transeuntes.</p>	<p>Perforación de placas apiladas</p> <p>Esto no es posible con la Integrex debido a un disco que se forma cuando el taladro a través de las placas.</p> <p>Precaución: Durante las operaciones a través de agujeros, una babosa o disco se produce como la herramienta provocando saltos de la pieza. Cuando la perforación es estacionaria y la pieza está girando, este disco puede ser lanzado desde el plato por la fuerza centrífuga. Proporcionar la protección adecuada para proteger a todos los transeúntes.</p>
Trepanning Drills					
Solid Carbide Drills					
Inserts					
Spare Parts					
Technical Data					

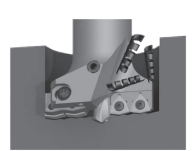
Problem Problema	Corrective Action	Possível Solução	Solución Posible
PILOT DRILL CRACKING 	On Lathes: <ul style="list-style-type: none"> • Verify that the tool is centered correctly. Readjust machine, if necessary. • Check clamping accuracy (tool and workpiece). 	Em Tornos: <ul style="list-style-type: none"> • Verifique se a ferramenta está centrada correctamente. Reajustar a máquina caso necessário. • Verifique a precisão do aperto (ferramento e peça). 	Tornos en: <ul style="list-style-type: none"> • Compruebe que la herramienta se centra correctamente. Reajustar la máquina, si es necesario. • Verificar la precisión de sujeción (herramienta y pieza de trabajo) para una posible mejora.
INSERT CRACKING 	<ul style="list-style-type: none"> • Use tougher carbide grade. • Check clamping accuracy (tool and workpiece) for possible run out. 	<ul style="list-style-type: none"> • Use classes de graus mais duras. • Verifique a precisão do aperto (ferramenta e peça). 	<ul style="list-style-type: none"> • Uso más duras de carburo de grado. • Verificar la precisión de sujeción (herramienta y pieza de trabajo) para su posible run out.
EXCESSIVE INSERT WEAR 	<ul style="list-style-type: none"> • Use coated pilot drill. • Increase coolant pressure and volume. • Reduce speed by 20% • Use wear & resistant carbide grade. 	<ul style="list-style-type: none"> • Utilizar uma broca piloto revestida. • Aumentar o volume e a pressão do líquido de refrigeração. • Reduzir a velocidade de corte em 20%. • Utilizar classes de graus mais resistentes ao desgaste. 	<ul style="list-style-type: none"> • Utilice broca piloto revestida. • Aumentar la presión del refrigerante y el volumen. • Reduzca la velocidad en un 20% • Utilice el desgaste y resistentes de carburo de grado.
CHIP BREAKING NOT OPTIMAL 	<ul style="list-style-type: none"> • Optimize chip control for given application by using different chipbreaker geometry. • Increase cutting speed by 20%; reduce feed by 20%. 	<ul style="list-style-type: none"> • Optimizar o controlo da apar numa determinada operação outra geometria de quebra aparas. • Aumentar a velocidade de corte em 20% e reduzir o avanço em 20%. 	<ul style="list-style-type: none"> • Optimizar el control de viruta numa dada aplicación mediante utilización de otra geometría quebra viruta • Aumentar la velocidad de corte en un 20%, reducir la alimentación en un 20%.
CHIP EVACUATION NOT OPTIMAL, POOR DRILL HOLE QUALITY 	<ul style="list-style-type: none"> • Increase coolant pressure and volume. • Increase cutting speed by 20%. 	<ul style="list-style-type: none"> • Aumentar o volume e a pressão do líquido de refrigeração. • Aumentar a velocidade de corte em 20%. 	<ul style="list-style-type: none"> • Aumentar la presión del refrigerante y el volumen. • Aumentar la velocidad de corte en un 20%.

SAFETY

Caution:

• During trough-hole operations, a slug or disc is produced as the tool breaks through the workpiece. When the drill is stationary and the workpiece is rotating, this slug may be hurled from the chuck by centrifugal force. Provide adequate shielding to protect all bystanders.

• When drilling through, a small shoulder will be produced on breakthrough as the pilot drill is no longer cutting.

TREPANING DRILLS - CUTTING PARAMETERS AND ADJUSTMENTS

Parâmetros de corte e ajustes | Condiciones de corte y ajustes

DRILLING

Jet Drills

Integrex Drills

Vortex Drills

Trepanning Drills

Solid Carbide Drills

Inserts

Spare Parts

Technical Data

Recommended Speeds and Feeds | Parâmetros de Corte Recomendados Recomendaciones de Datos de Corte

ISO	Material Group Grupo Materiais Grupo Materiales	DC (mm)	Fn (mm/r)	Vc (m/min)
P	UNALLOYED STEEL (-0,25%)	60-110	0,07-0,20	130-345
	LOW-ALLOY STEEL (0,25%-)	60-110	0,10-0,20	100-210
	LOW-ALLOY STEEL	60-110	0,10-0,20	90-200
	STEEL CASTING	60-110	0,06-0,18	120-280
M	STAINLESS STEEL	60-110	0,10-0,20	100-240
K	GREY CAST IRON	60-110	0,14-0,26	105-280
	CAST IRON WITH NODULAR CAST	60-110	0,14-0,20	110-195
N	ALUMINIUM FORGING ALLOYS	60-110	0,12-0,22	250-400
	COPPER AND COPPER ALLOYS	60-110	0,12-0,22	180-350

Power Requirements | Requisitos de Potência | Requisitos de Potencia

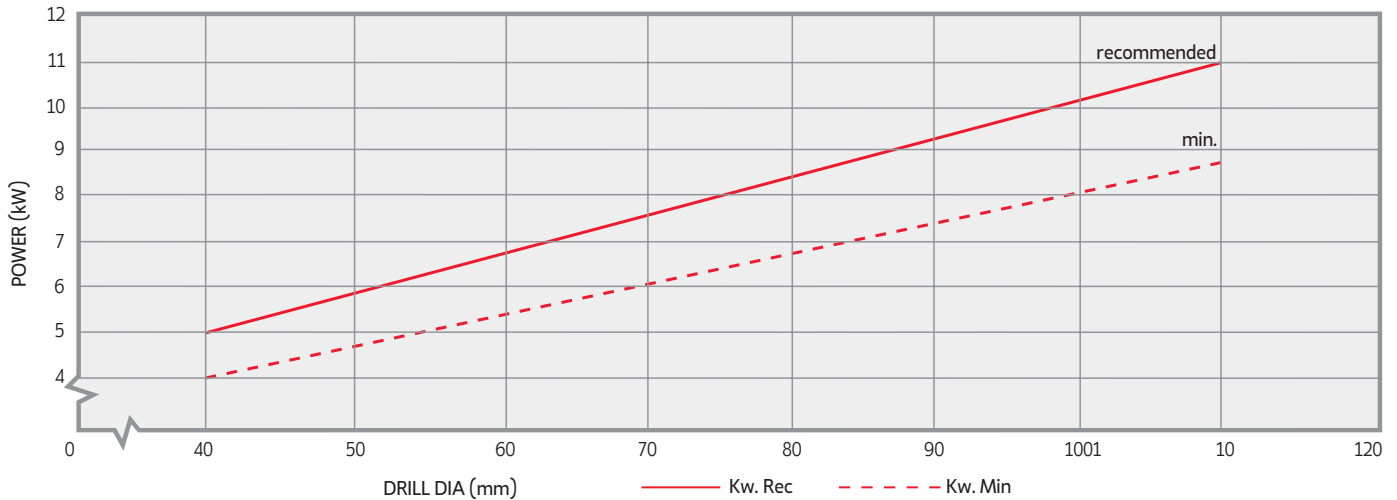

• The cutting fluid quantity is measured at the cutting edge of the drill

Coolant Application Chart | Tabela Aplicação de Refrigeração | Tabla Aplicación de Refrigerante

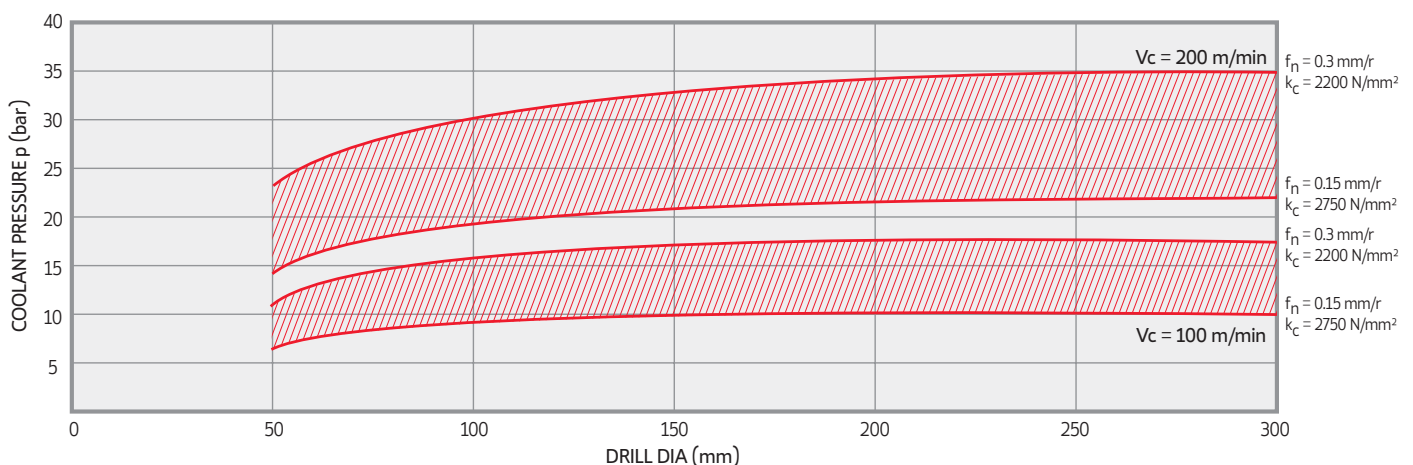

SOLID CARBIDE DRILLS - CUTTING PARAMETERS AND ADJUSTMENTS

Parâmetros de corte e ajustes | Condiciones de corte y ajustes

Recommended Speeds and Feeds | Parâmetros de Corte Recomendados Recomendaciones de Datos de Corte

ISO	Material Group Grupo Materiais Grupo Materiales	Vc (m/min)	f (mm/rev)			
			Ø3-8mm	Ø8-12mm	Ø12-16mm	Ø16-20mm
P	UNALLOYED STEEL (-0,25%)	80-100	0,10-0,20	0,15-0,25	0,20-0,40	0,25-0,50
	LOW-ALLOY STEEL (0,25%-)	70-100	0,10-0,20	0,20-0,30	0,20-0,35	0,25-0,40
	HIGH-ALLOY STEEL	40-70	0,08-0,15	0,12-0,22	0,20-0,40	0,25-0,40
M	STAINLESS STEEL	35-50	0,08-0,15	0,12-0,25	0,15-0,30	0,20-0,35
K	MALEABLE CAST IRON	70-100	0,10-0,30	0,20-0,40	0,25-0,40	0,25-0,50
	GREY CAST IRON	70-100	0,10-0,25	0,20-0,35	0,30-0,45	0,35-0,55

Coolant Application Chart | Tabela Aplicação de Refrigeração | Tabla Aplicación de Refrigerante

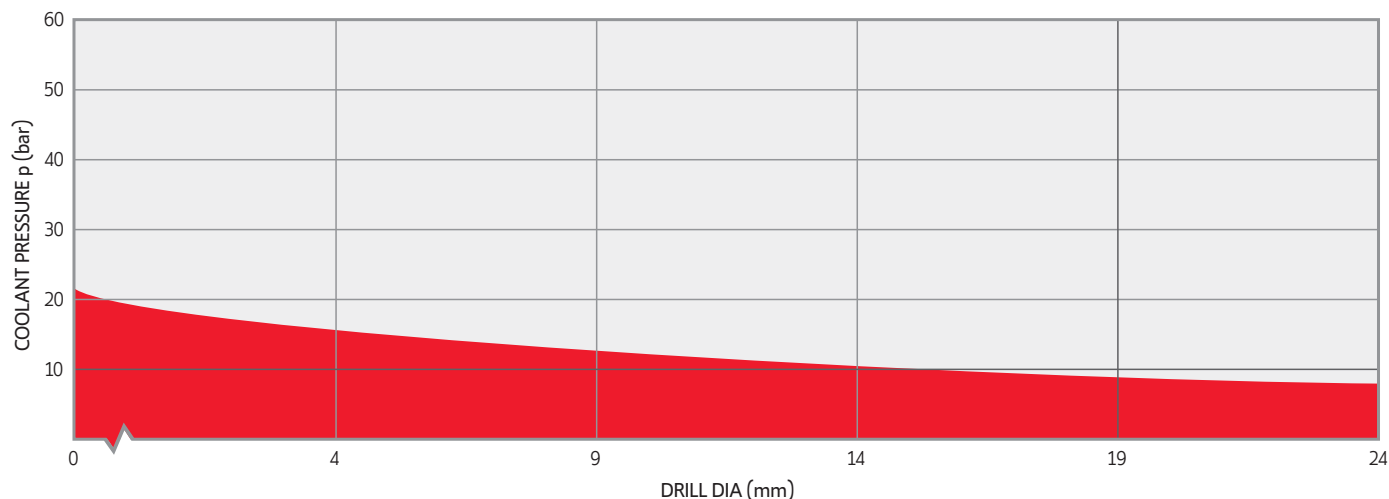

SOLID CARBIDE DRILLS - TROUBLESHOOTING

Problem Problema	Cause Causa Fuente	Possible Solution Solução Solución
Heavy wear on the cutting corners Desgaste profundo das arestas de corte Desgaste profundo de los gavilanes	<ul style="list-style-type: none"> Spintering on the cutting corners Estilhamento das esquinas de corte Astillado en las esquinas de corte 	<ul style="list-style-type: none"> Check cooling lubricant. In the case of internal coolant supply, increase coolant pressure. In the case of external coolant supply, adjust positioning of coolant jet. Cool from both sides. Veja o lubrificante. No caso de fornecimento interno, aumente a pressão da refrigeração, no caso de fornecimento externo, ajuste o posicionamento do jorro do refrigerante, esfrie ambos os lados. Compruebe el lubricante de refrigeración. En caso de suministro de refrigerante interno, aumente la presión del refrigerante. En caso de suministro de refrigerante externo, ajuste el posicionamiento del chorro de refrigerante. Enfrie desde ambos lados.
	<ul style="list-style-type: none"> Cutting conditions Condições de corte Condiciones de corte 	<ul style="list-style-type: none"> Reduce cutting speed, increase feed. Reduza a velocidade de corte, aumente o avanço. Reduzca la velocidad de corte, aumente el avance.
Spintering on the chisel edge Estilhamento do fio de corte transversal Astillado del filo de corte transversal	<ul style="list-style-type: none"> Clamping chuck Sistema de amarrar Sistema amarrar 	<ul style="list-style-type: none"> Check clamping accuracy. Use hydraulic clamping chuck or high-precision chucking system. Comprove a precisão da fixação utilize uma pinça de fixação hidráulica ou um sistema de aperto de alta precisão. Compruebe la precisión de la fijación. Utilice una pinza de fijación hidráulica o un sistema de amarrar de alta precisión.
	<ul style="list-style-type: none"> Cutting conditions Condições de corte Condiciones de corte 	<ul style="list-style-type: none"> Increase feed. Aumente o avanço. Aumente el avance.
Built-up edge Acrescimo do fio de corte Recrecimiento del filo de corte	<ul style="list-style-type: none"> Insufficient coolant. Refrigeração insuficiente Refrigerante insuficiente 	<ul style="list-style-type: none"> Check cooling lubricant. In the case of internal coolant supply, increase coolant pressure. In the case of external coolant supply, adjust positioning of coolant jet. Cool from both sides. Veja o lubrificante. No caso de fornecimento interno, aumente a pressão da refrigeração, no caso de fornecimento externo, ajuste o posicionamento do jorro do refrigerante, esfrie ambos os lados. Compruebe el lubricante de refrigeración. En caso de suministro de refrigerante interno, aumente la presión del refrigerante. En caso de suministro de refrigerante externo, ajuste el posicionamiento del chorro de refrigerante. Enfrie desde ambos lados.
	<ul style="list-style-type: none"> Cutting conditions Condições de corte Condiciones de corte 	<ul style="list-style-type: none"> Increase speed 20-30%. Aumente a velocidade em uns 20% a 30%. Aumente la velocidad en un 20-30%.
Spintering on the cutting edges Estilhamento do fio de corte principal Astillado del filo de corte principal	<ul style="list-style-type: none"> Clamping chuck Sistema de amarrar Sistema amarrar 	<ul style="list-style-type: none"> Check clamping accuracy and torque transmission. Use hydraulic clamping chuck or high-precision chucking system. Comprove a precisão da fixação utilize uma pinça de fixação hidráulica ou um sistema de aperto de alta precisão. Compruebe la precisión de la fijación y la transmisión de par. Utilice una pinza de fijación hidráulica o un sistema de amarrar de alta precisión.
	<ul style="list-style-type: none"> Cutting conditions caused by built-up edge Condições de corte provocadas por acrecimos no fio de corte Condiciones de corte provocadas por recrecimiento del filo de corte 	<ul style="list-style-type: none"> Check cutting values and, possibly increase cutting speed. Examine regularly for built-up edge. Veja os valores de corte e a ser possível aumente a velocidade de corte. Examine regularmente o aumento do fio de corte. Compruebe los valores de corte y a ser posible aumente la velocidad de corte. Examine regularmente el recrecimiento del filo de corte.
Thermal checking / Comb cracking Desgaste / Rotura dos chanfros Desgaste / Rotura de los chaflanes	<ul style="list-style-type: none"> Cutting conditions Condições de corte Condiciones de corte 	<ul style="list-style-type: none"> Inconsistent / insufficient coolant supply. Fornecimento de refrigeração, inconsistente/insuficiente. Suministro de refrigerante inconsistente/insuficiente.
Heavy wear on the cutting corners Desgaste profundo dos chanfros Desgaste profundo de los chaflanes	<ul style="list-style-type: none"> Workpiece movement Movimento das peças de trabalho Movimiento de piezas de trabajo 	<ul style="list-style-type: none"> Stabilize workpiece chucking and check stability of machine tool. Estabilize a fixação da peça de trabalho e veja a estabilidade da máquina ferramenta. Estabilice la fijación de la pieza de trabajo y compruebe la estabilidad de la máquina herramienta
	<ul style="list-style-type: none"> Insufficient coolant Refrigeração insuficiente Refrigerante insuficiente 	<ul style="list-style-type: none"> Check cooling lubricant. In the case of internal coolant supply, increase coolant pressure. In the case of external coolant supply, adjust positioning of coolant jet. Cool from both sides. Veja o lubrificante. No caso de fornecimento interno, aumente a pressão da refrigeração, no caso de fornecimento externo, ajuste o posicionamento do jorro do refrigerante, esfrie ambos os lados. Compruebe el lubricante de refrigeración. En caso de suministro de refrigerante interno, aumente la presión del refrigerante. En caso de suministro de refrigerante externo, ajuste el posicionamiento del chorro de refrigerante. Enfrie desde ambos lados.
	<ul style="list-style-type: none"> Wrong drill Broca incorrecta Broca incorrecta 	<ul style="list-style-type: none"> Check drill type, drilling depth, cooling system, and workpiece material. Veja o tipo de broca, a profundidade do furo, o sistema de refrigeração e o material de trabalho. Compruebe el tipo de broca, la profundidad de taladrado, el sistema de refrigeración y el material de trabajo.
	<ul style="list-style-type: none"> Cutting conditions Condições de corte Condiciones de corte 	<ul style="list-style-type: none"> Check cutting parameters at exit. Reduce feed 15-20% prior to breakout. Revise os parâmetros de corte de saída. Reduza o avanço em uns 15% a 20% antes da rotura. Revise los parámetros de corte de la salida. Reduzca el avance en un 15-20% antes de la rotura.
Hole too big Furo demasiado grande Orificio demasiado grande	<ul style="list-style-type: none"> Cutting conditions Condições de corte Condiciones de corte 	<ul style="list-style-type: none"> Check cutting values, increase cutting speed, or reduce feed. Comprove os valores de corte, aumente a velocidade de corte e reduza o avanço. Compruebe los valores de corte, aumente la velocidad de corte o reduzca el avance.
	<ul style="list-style-type: none"> Clamping chuck Sistema de amarrar Sistema amarrar 	<ul style="list-style-type: none"> Check clamping accuracy and torque transmission. Use hydraulic clamping chuck or high-precision chucking system. Comprove a precisão da fixação utilize uma pinça de fixação hidráulica ou um sistema de aperto de alta precisão. Compruebe la precisión de la fijación y la transmisión de par. Utilice una pinza de fijación hidráulica o un sistema de amarrar de alta precisión.
	<ul style="list-style-type: none"> Wrong drill Broca incorrecta Broca incorrecta 	<ul style="list-style-type: none"> Check drill diameter. Please notice that drills are ground to a positive tolerance. Check concentric running. Veja o diâmetro da broca. Assegure-se que as brocas estão ligadas a uma tolerância positiva. Comprove que o funcionamento é concêntrico. Compruebe el diámetro de la broca. Asegúrese de que las brocas están conectadas a una tolerancia positiva. Compruebe el funcionamiento concéntrico.

Problem Problema	Cause Causa Fuente	Possible Solution Solução Solución
Hole too small Furo demasiado pequeno Orificio demasiado pequeno	<ul style="list-style-type: none"> • Insufficient coolant • Refrigeração insuficiente • Refrigerante insuficiente 	<ul style="list-style-type: none"> • Check cooling lubricant. In the case of internal coolant supply, increase coolant pressure. In the case of external coolant supply, adjusting positioning of coolant jet. Cool from both sides. • Veja o lubrificante. No caso de fornecimento interno, aumente a pressão da refrigeração, no caso de fornecimento externo, ajuste o posicionamento do jorro do refrigerante, esfrie ambos lados. • Compruebe el lubricante de refrigeración. En caso de suministro de refrigerante interno, aumente la presión del refrigerante. En caso de suministro de refrigerante externo, ajuste el posicionamiento del chorro de refrigerante. Enfrie desde ambos lados.
	<ul style="list-style-type: none"> • Cutting conditions • Condições de corte • Condiciones de corte 	<ul style="list-style-type: none"> • Reduce cutting speed; increase feed. • Reduza a velocidade de corte, aumente o avanço. • Reduzca la velocidad de corte, aumente el avance.
	<ul style="list-style-type: none"> • Wrong drill • Broca incorrecta • Broca incorrecta 	<ul style="list-style-type: none"> • Check cutting-edge diameter. • Veja o diâmetro do fio de corte. • Compruebe el diámetro del filo de corte.
Hole not cylindrical Furo não está recto Orificio no es recto	<ul style="list-style-type: none"> • Clamping chuck • Sistema de amarre • Sistema amarre 	<ul style="list-style-type: none"> • Check clamping accuracy and torque transmission. Use hydraulic clamping chuck or high-precision chucking system. • Veja a precisão da fixação e a transmissão do par. Utilize uma pinça de fixação hidráulica ou um sistema de aperto de alta precisão. • Compruebe la precisión de la fijación y la transmisión de par. Utilice una pinza de fijación hidráulica o un sistema de amarre de alta precisión.
	<ul style="list-style-type: none"> • Workpiece movement • Movimento das peças de trabalho • Movimiento de piezas de trabajo 	<ul style="list-style-type: none"> • Stabilize workpiece chucking and check stability of machine tool. • Estabilize a fixação da peça de trabalho e veja a estabilidade da máquina ferramenta. • Estabilice la fijación de la pieza de trabajo y compruebe la estabilidad de la máquina herramienta.
	<ul style="list-style-type: none"> • Wrong drill • Broca incorreta • Broca incorrecta 	<ul style="list-style-type: none"> • Check drill type and drilling depth. Use longer drills • Veja o tipo de broca e a profundidade do furo. Utilize brocas mais largas. • Compruebe el tipo de broca y la profundidad de taladrado. Utilice brocas más largas.
	<ul style="list-style-type: none"> • Cutting conditions • Condições de corte • Condiciones de corte 	<ul style="list-style-type: none"> • Reduce feed at entry. • Reduza o avanço de entrada. • Reduzca el avance de la entrada.
Drill Breakage Rotura da broca Rotura de broca	<ul style="list-style-type: none"> • Clamping chuck • Sistema de amarre • Sistema amarre 	<ul style="list-style-type: none"> • Check clamping accuracy and torque transmission. Use hydraulic clamping chuck or high-precision chucking system. • Veja a precisão da fixação e a transmissão do par. Utilize uma pinça de fixação hidráulica ou um sistema de aperto de alta precisão. • Compruebe la precisión de la fijación y la transmisión de par. Utilice una pinza de fijación hidráulica o un sistema de amarre de alta precisión.
	<ul style="list-style-type: none"> • Workpiece movement • Movimento das peças de trabalho • Movimiento de piezas de trabajo 	<ul style="list-style-type: none"> • Stabilize workpiece chucking and check stability of machine tool. • Estabilize a fixação da peça de trabalho e veja a estabilidade da máquina ferramenta. • Estabilice la fijación de la pieza de trabajo y compruebe la estabilidad de la máquina herramienta.
	<ul style="list-style-type: none"> • Wrong drill • Broca incorreta • Broca incorrecta 	<ul style="list-style-type: none"> • Check drill type, drilling depth, cooling system, and workpiece material. • Veja o tipo de broca, a profundidade do furo, o sistema de refrigeração e o material de trabalho. • Compruebe el tipo de broca, la profundidad de taladrado, el sistema de refrigeración y el material de trabajo.
	<ul style="list-style-type: none"> • Insufficient coolant • Refrigeração insuficiente • Refrigerante insuficiente 	<ul style="list-style-type: none"> • Check cooling lubricant. In the case of internal coolant supply, increase coolant pressure. In the case of external coolant supply, adjusting positioning of coolant jet. Cool from both sides. • Veja o lubrificante. No caso de fornecimento interno, aumente a pressão da refrigeração, no caso de fornecimento externo, ajuste o posicionamento do jorro do refrigerante, esfrie ambos lados. • Compruebe el lubricante de refrigeración. En caso de suministro de refrigerante interno, aumente la presión del refrigerante. En caso de suministro de refrigerante externo, ajuste el posicionamiento del chorro de refrigerante. Enfrie desde ambos lados.
Splintering on the cutting corners Estilhamento das esquinas de corte Astillado en las esquinas de corte	<ul style="list-style-type: none"> • Cutting conditions • Condições de corte • Condiciones de corte 	<ul style="list-style-type: none"> • Check cutting values, and possibly reduce feed. • Comprove os valores de corte, aumente a velocidade de corte e reduza o avanço. • Compruebe los valores de corte y a ser posible reduzca el avance.
	<ul style="list-style-type: none"> • Clamping chuck • Sistema de amarre • Sistema amarre 	<ul style="list-style-type: none"> • Check torque transmission. Use hydraulic clamping chuck or high-precision chucking system. • Comprove a transmissão do par. Utilize uma pinça de fixação hidráulica ou um sistema de aperto de alta precisão. • Compruebe la transmisión de par. Utilice una pinza de fijación hidráulica o un sistema de amarre de alta precisión.
	<ul style="list-style-type: none"> • Workpiece movement • Movimento das peças de trabalho • Movimiento de piezas de trabajo 	<ul style="list-style-type: none"> • Stabilize workpiece chucking and check stability of machine tool. • Estabilize a fixação da peça de trabalho e veja a estabilidade da máquina ferramenta. • Estabilice la fijación de la pieza de trabajo y compruebe la estabilidad de la máquina herramienta.
Splintering on the cutting corners Estilhamento das esquinas de corte Astillado en las esquinas de corte	<ul style="list-style-type: none"> • Wrong drill • Broca incorreta • Broca incorrecta 	<ul style="list-style-type: none"> • Check drill type, drilling depth, cooling system, and workpiece material. Possibly, use longer drill. • Comprove o tipo de broca, a profundidade do furo, sistema de refrigeração e o material de trabalho. A ser possível utilize uma broca mais larga. • Compruebe el tipo de broca, la profundidad de taladrado, sistema de refrigeración y material de trabajo. A ser posible, utilice una broca más larga.
	<ul style="list-style-type: none"> • Insufficient coolant • Refrigeração insuficiente • Refrigerante insuficiente 	<ul style="list-style-type: none"> • Check cooling lubricant. In the case of internal coolant supply, increase coolant pressure. In the case of external coolant supply, adjusting positioning of coolant jet. Cool from both sides. • Veja o lubrificante. No caso de fornecimento interno, aumente a pressão da refrigeração, no caso de fornecimento externo, ajuste o posicionamento do jorro do refrigerante, esfrie ambos lados. • Compruebe el lubricante de refrigeración. En caso de suministro de refrigerante interno, aumente la presión del refrigerante. En caso de suministro de refrigerante externo, ajuste el posicionamiento del chorro de refrigerante. Enfrie desde ambos lados.
	<ul style="list-style-type: none"> • Cutting conditions • Condições de corte • Condiciones de corte 	<ul style="list-style-type: none"> • Check cutting values, and possibly reduce feed. • Comprove os valores de corte, aumente a velocidade de corte e reduza o avanço. • Compruebe los valores de corte y a ser posible reduzca el avance.

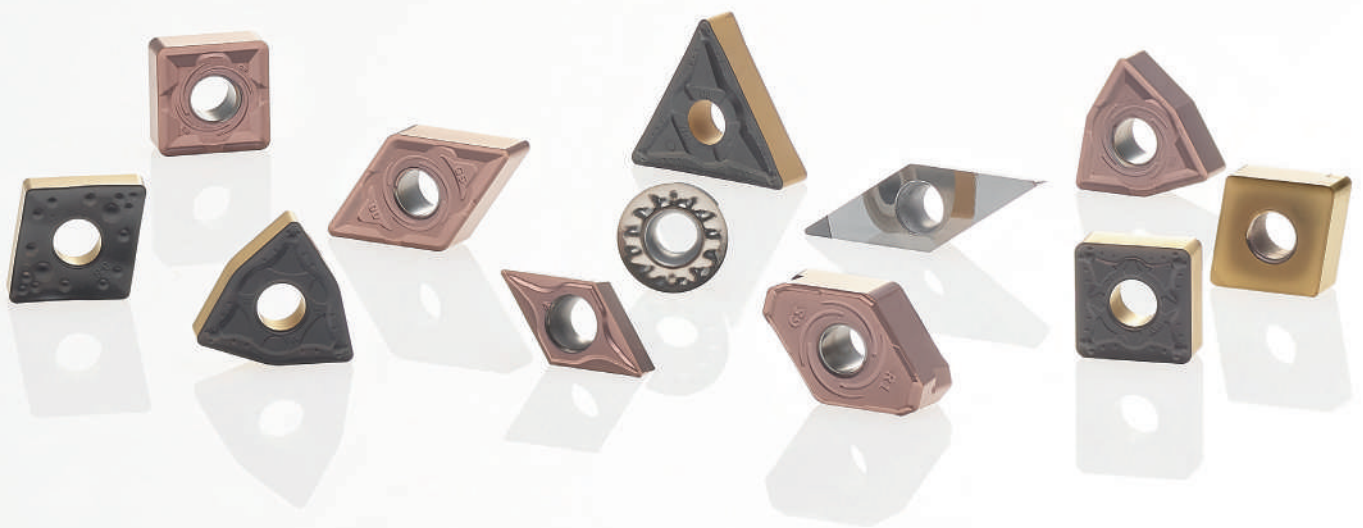

C - TURNING

C - 368 | New turning grades

C - 370 | ISO turning inserts code key

C - 372 | Insert selection

C - 380 | Inserts overview

C - 384 | New DOMX



TURNING



C - 388 | Negative turning inserts

C - 426 | Positive turning inserts

C - 460 | PCBN & PCD inserts

C - 497 | Heavy turning inserts

C - 504 | Railway turning inserts

C - 518 | External Toolholders

C - 608 | Internal Toolholders

C - 684 | Automatic Lathes

C - 696 | Spare Parts

C - 704 | Technical Data

PCD GRADE FOR MACHINING NON-FERROUS MATERIALS

NEW

Grau PCD para maquinar materiais não-ferrosos | Calidad PCD para maquinar materiales no-ferrosos

LASER MACHINING TECHNOLOGY

- High cutting edge quality
- Customized chip-breaker according to our customers' needs

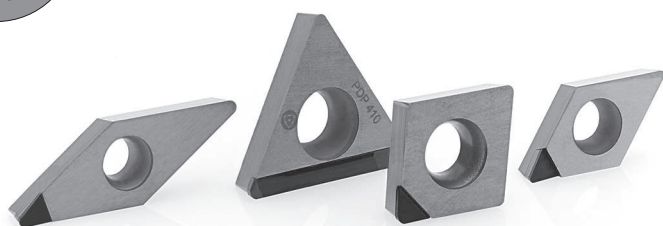
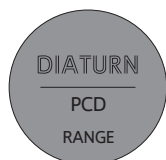

Used in 90% of all applications in non-ferrous materials. Ideal for aluminium alloys (Si ≤ 12%), graphite and graphite composites

Extreme edge sharpness/retention achieving a fine surface finishing.



Machining of Al/Si alloys with high Si content (Si ≥ 12%)

Excellent abrasion resistance and good thermal stability.

PCBN GRADE FOR MACHINING HARDENED MATERIALS

NEW

Grau PCBN para maquinar materiais endurecidos | Calidad PCBN para maquinar materiales endurecidos



Machining of hardened materials in high continuous cut up to 200m/min cutting speed.

Can be used on high resistance alloys. (New PVD coating for PCBN inserts with improved wear resistance.)



Machining of hardened materials in light to heavy interrupted cuts.

Enhanced crater and flank wear resistance with an excellent balance of toughness.

WIPER INSERT || Pastilha wiper | Plaquita wiper

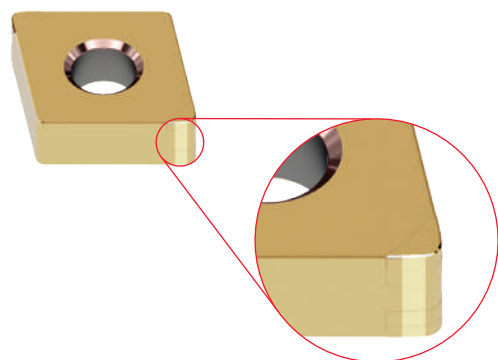

Wiper inserts provide two possibilities for process improvement:

- Improved surface finish with standard cutting data;
- Maintained surface finish at substantially higher feed rate.

TURNING
Insert selection
Overview
Negative inserts
Positive inserts
PCBN & PCD inserts
Heavy turning
External Toolholders
Internal Toolholders
Automatic Lathes
Spare Parts
Technical Data

PHH NEW GRADE - THE CUTTING EDGE TECHNOLOGY FOR SUPERALLOYS TURNING

NEW

Novo grau PHH - A tecnologia de ponta para super-ligas em torneamento | Nueva calidad PHH - La tecnología de vanguardia para superaleaciones en torneado

A NEW TURN FOR STAINLESS STEEL AND HRSA TURNING



PHH910
M05-M10
S05-S15

PHH920
M10-M25
S15-S30

An hard micro grain substrate combined with a thin optimized nanostructure PVD coating with excelent heat dissipation

The solution for Stainless steel and HRSA from medium turning to finishing.
For continuous to semi-interrupted turning.
First choice for HRSA.

DOMX - THE REVOLUTION IN HRSA MEDIUM TO ROUGH TURNING

NEW

A revolução em torneamento de materiais termorresistentes | La revolución en el torneado de materiales exóticos

Designed especially for HRSA, the new DOMX combined with the latest PHH technology, offers exceptional performance in exotic materials machining. When your material has high Ni or Co content DOMX is the choice!

- First choice for **HRSA** medium to rough turning;
- 4 positive cutting edges on double sided insert.**

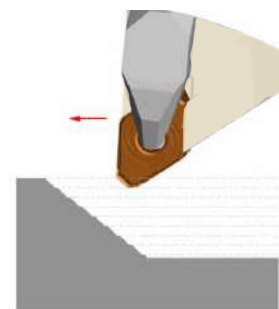

- Machine at 45° with a 93° holder;
- Up to + 140% tool life improvement.**

ISO TURNING INSERTS CODE KEY

H		M	
O		V	
P		W	
S		L	
T		A	
C		B	
D		K	
E		R	
F		X	Special

1 - Insert shape symbol

Symbol	m (mm)	d (mm)	s (mm)
A	±0.005	±0.025	±0.025
F	±0.005	±0.013	±0.025
C	±0.013	±0.025	±0.025
H	±0.013	±0.013	±0.025
E	±0.025	±0.025	±0.025
G	±0.025	±0.025	±0.13
J	±0.005	±0.05~±0.13	±0.025
K*	±0.013	±0.05~±0.13	±0.025
L*	±0.025	±0.05~±0.13	±0.025
M*	±0.08~±0.20	±0.05~±0.13	±0.13
N*	±0.08~±0.20	±0.05~±0.13	±0.025
U*	±0.13~±0.38	±0.08~±0.25	±0.13

Triangular inserts with a facet (secondary cutting edge)

Detailed dimension of M class insert Insert height Tolerances (mm)					
Inscribed circle	T	S	C	D	V
6.35	±0.08	-	-	-	-
9.525	±0.08	±0.08	±0.11	±0.10	±0.13
12.70	±0.13	±0.13	±0.13	±0.15	-
15.875	±0.15	±0.15	±0.15	±0.18	-
19.05	±0.15	±0.15	±0.15	±0.18	-
25.40	-	±0.18	-	-	-
31.75	-	±0.25	-	-	-

Inscribed circle Tolerances (mm)					
Inscribed circle	T	S	C	D	V
6.35	±0.05	-	-	-	-
9.525	±0.05	±0.05	±0.05	±0.05	±0.05
12.70	±0.08	±0.08	±0.08	±0.08	±0.08
15.875	±0.10	±0.10	±0.10	±0.10	±0.10
19.05	-	-	-	-	±0.10
25.40	-	±0.13	-	-	±0.10
31.75	-	±0.20	-	-	±0.12

3 - Tolerances symbol

*As a rule, the sides of these inserts are as sintered. Tolerance differs with insert size, for the accuracy of class M, refer to the table on the right.

A	B	C	D	E
				Other clearance angle

2 - Normal clearance symbol



4 - Insert symbol															
symbol	Type	Hole type	Chipbreaker	Shape	symbol	Type	Hole type	Chipbreaker	Shape	symbol	Type	Hole type	Chipbreaker	Shape	
W	with hole	Round hole / one countersink (40°-60°)	Without chipbreaker		H	with hole	Round hole / one countersink (70°-90°)	Chipbreaker on one side		G	with hole	Round hole	Chipbreaker on both sides		
T			Chipbreaker on one side		C		Round hole / double countersink (70°-90°)	Without chipbreaker		N		-	Without chipbreaker		
Q		Round hole / double countersink (40°-60°)	Without chipbreaker		J		Round hole	Round hole	Chipbreaker on both sides		R	without hole	-	Chipbreaker on one side	
U			Chipbreaker on both sides		A				Without chipbreaker		F		-	Chipbreaker on both sides	
B		Round hole / one countersink (70°-90°)	Without chipbreaker		M		Chipbreaker on one side		X	-	-	-	-	-	On request

Sistema de codificação para pastilhas de torneamento ISO

Codificación para plaquitas de torneado ISO

R's	35° V's	55° D's	80° C's	90° S's	60° T's	80° W's	Ø CI		ANSI
							mm	inch	Symbol
-	06	04	-	03	06	02	3,97	5/32	1,20
-	08	05	04	04	08	L3	4,76	3/16	1,50
-	09	06	05	05	09	03	5,56	7/32	1,80
06**	-	-	-	-	-	-	6,00	0,236	
06*	11	07	06	06	11	04	6,35	1/4	2,00
07*	13	09	08	07	13	05	7,94	5/16	2,50
08*	-	-	-	-	-	-	8,00	0,315	
09*	16	11	09	09	16	06	9,525	3/8	3,00
10**	-	-	-	-	-	-	10,00	0,394	
12**	-	-	-	-	-	-	12,00	0,472	
12*	22	15	12	12	22	08	12,70	1/2	4,00
15*	27	19	16	15	27	10	15,875	5/8	5,00
16**	-	-	-	-	-	-	16,00	0,63	
19*	33	23	19	19	33	13	19,05	3/4	6,00
20**	-	-	-	-	-	-	20,00	0,787	
25**	-	-	-	-	-	-	25,00	0,984	
25*	44	31	25	25	44	17	25,40	1,00	8,00
31*	54	38	32	31	54	21	31,75	1 1/4	10,00
32**	-	-	-	-	-	-	32,00	1,26	

5 - Insert size symbol

* ANSI designation only (Radius Designation is R0)

** Metric designation only (Radius Designation is M0)

According to International Standard ISO 1832 - 2012(E)

"Indexable inserts for cutting tools - Designation"

ISO	mm	ANSI	inch
01	1.59	1	0.062
T1	1.98	1.2	0.078
02	2.38	1.5	0.094
03	3.18	2	0.125
T3	3.97	2.5	0.156
04	4.76	3	0.188
05	5.56	3.5	0.219
06	6.35	4	0.250
07	7.94	5	0.312
09	9.52	6	0.375
12	12.70	8	0.500

6 - Insert thickness symbol



10 - Chipbreaker geometries					
FLAT	MF	GS	SF	LC	MS
MR	PM	ST	MW	SS	HR
MA	RP	HY	HZ	GR	

FLAT	FP	BO	FM	FK	FW	LM	MP	MM
MK	MW	FS	LN	GS	ST	RF	RM	RR

7 - Insert corner symbol			
ISO	mm	inch	ANSI
00	Sharp nose		0
01	0.10	.004	0.2
02	0.20	.008	0.5
04	0.40	.015	1
08	0.80	.032	2
12	1.2	.047	3
16	1.6	.062	4
20	2.0	.078	5
24	2.4	.094	6
28	2.8	.109	7
32	3.2	.125	8
00 (inch or M0/metric)	Round insert		0

7.1* - Insert edges symbol			
For inserts having secondary edges two digits are used:			
1 st digit is secondary edge		2 nd digit is secondary edges relief angle	
A	45°	A	3°
D	60°	B	5°
E	75°	C	7°
F	85°	D	15°
P	90°	E	20°
Z	special	F	25°
*only when required.		G	30°
		N	0°
		P	11°
		Z	special

8* - Cutting edge information		
Shape	Honing	Symbol
	No honing	F
	With honing	E
	Chamfered No honing	T
	Chamfered with honing	S
*only when required.		

9* - Cutting direction		
Shape	Hand	Symbol
	Right	R
	Left	L
	None	N
*only when required.		

INSERTS RECOMENDATION

EXTERNAL MACHINING | MAQUINAÇÃO EXTERNA | MAQUINACIÓN EXTERNA

General Recommendation:

1. The choice of the insert shape depends of the operation
2. The insert shape should be selected to the required lead angle and the accessibility or versatility required of the tool.
3. Select the largest suitable point angle on the insert for strenght and economy.

Operation	Longitudinal turning	Profiling	Facing	Plunging
Insert Shape				
Rhombic 80°	●●		●	
Rhombic 55°	●	●●	●	
Parallelogram 55°	●	●		●
Round	●	●	●	●●
Square 90°	●		●●	
Triangular 60°	●	●	●	●
Rhombic 35°		●		
Trigon 80°	●		●	







●● Recommended Insert Shape

● Alternative Insert Shape

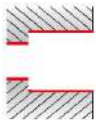
INTERNAL MACHINING | MAQUINAÇÃO INTERNA | MAQUINACIÓN INTERNA

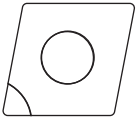
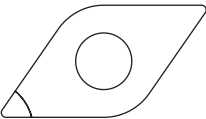
General Recommendation:

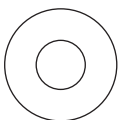
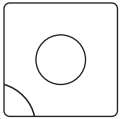
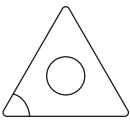
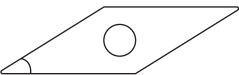
1. The choice of the insert shape depends of the operation
2. The insert shape should be selected to the required lead angle and the accessibility or versatility required of the tool.
3. Select the largest suitable point angle on the insert for strenght and economy.

Insert Shape \ Operation		Longitudinal turning	Profiling	Facing
				
	Rhombic 80°	●		●●
	Rhombic 55°	●	●●	●
	Parallelogram 55°	●●		
	Round	●		●
	Square 90°	●		
	Triangular 60°	●●	●	●
	Rhombic 35°		●	
	Trigon 80°	●		●











●● Recommended Insert Shape

● Alternative Insert Shape





NEGATIVE TURNING Application Range Overview



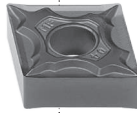
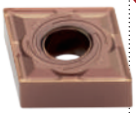

- TURNING
- Insert selection
- Overview
- Negative inserts
- Positive inserts
- PCBN & PCD inserts
- Heavy turning
- External Toolholders
- Internal Toolholders
- Automatic Lathes
- Spare Parts
- Technical Data

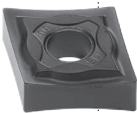
P





Fine finishing	Finishing		Medium	Roughing	Heavy roughing
	MF	LC	MR	HR	
					
			PM	MA ^{NEW}	RP
					
					1 face
			MW	GR ^{NEW}	HZ
					
			wiper		1 face
CVD Grades					
	PHG105 P05-P10	PHG115 P10-P25	PH5125 P20-P35	PHG125 P20-P35	PH5740 P25-P45
					PHG140 P25-P45
PVD Grades					
	PH7910 P05-P10				
Continuous cut ←			→ Interrupted cut		

M

Fine finishing	Finishing		Medium	Roughing	Heavy roughing
	MF	GS ^{NEW}	SF	SS	
					
		MS		RP	HY
					
				1 face	1 face
CVD Grades					
	PHS215 M10-M25		PHS225 M15-M30		PHS240 M25-M45
PVD Grades					
	PH7910 M05-M10	PHH910 ^{NEW} M05-M10	PH7920 M10-M25	PHH920 ^{NEW} M30-M25	
Continuous cut ←			→ Interrupted cut		

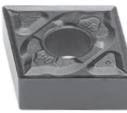
K	Fine finishing	Finishing	Medium	Roughing	Heavy roughing
				ST 	FLAT 
			MW 	wiper	HZ 
CVD Grades					
		PH5705 K05-K15		PH5320 K10-K25	PH5740 K20-K40
Continuous cut ← → Interrupted cut					

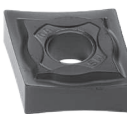

N	Fine finishing	Finishing	Medium	Roughing	Heavy roughing
				MS 	
Uncoated Grades					
			PH0910 N01-N20		
Continuous cut ← → Interrupted cut					

S	Fine finishing	Finishing	Medium	Roughing	Heavy roughing
			GS ^{NEW} 	SF 	SS 
			MS 		DOMX ^{NEW} 
PVD Grades					
		PH7910 S05-S10	PHH910 ^{NEW} S10-S25	PH7920 S10-S25	PHH920 ^{NEW} S10-S25
Continuous cut ← → Interrupted cut					

POSITIVE TURNING Application Range Overview

- TURNING
- Insert selection
- Overview
- Negative inserts
- Positive inserts
- PCBN & PCD inserts
- Heavy turning
- External Toolholders
- Internal Toolholders
- Automatic Lathes
- Spare Parts
- Technical Data





	Fine finishing	Finishing	Medium	Roughing		Heavy roughing	
P 5° & 7°	FS 	FP 	MP 	RF 	RM 		
	BO 	FW  wiper	MW  wiper	ST 	RR 		
	CVD Grades						
			PHG115 <small>P10-P25</small>	PH5125 <small>P20-P35</small>	PHG125 <small>P20-P35</small>	PHG140 <small>P25-P45</small>	PH5740 <small>P25-P45</small>
	PVD Grades						
		PH7910 <small>P05-P10</small>		PH7920 <small>P10-P35</small>			
	Continuous cut ← → Interrupted cut						

	Fine finishing	Finishing	Medium	Roughing	Heavy roughing	
P 11°		12 	13 	FLAT 		
	CVD Grades					
		PH5115 <small>P05-P20</small>	PH5125 <small>P20-P35</small>	PH5740 <small>P25-P45</small>		
	PVD Grades					
	Continuous cut ← → Interrupted cut					

M
5° & 7°

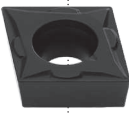
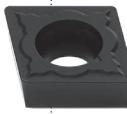
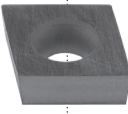
Fine finishing	Finishing		Medium	Roughing		Heavy roughing
FS 	FM 	LM 	MM 	RF 	RM 	
BO 	FW 	MW 	RCMT 	RR 		
CVD Grades						
	PHS215 M10-M25			PHS225 M15-M30		PHS240 M25-M45
PVD Grades						
PH7910 M05-M10	PHH910 M05-M10		PH7920 M10-M25	PHH920 M10-M25		
Continuous cut ←			→ Interrupted cut			

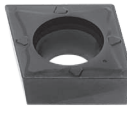



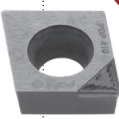

K
5° & 7°

Fine finishing	Finishing		Medium	Roughing	Heavy roughing
FK 	MK 	FLAT 		RM 	
	FW 	MW 		ST 	
CVD Grades					
	PH5705 K05-K15			PH5320 K10-K25	
Uncoated Grades					
	PH0705 K05-K15				
Continuous cut ←			→ Interrupted cut		

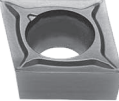
POSITIVE TURNING

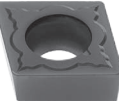





Application Range Overview | Vista geral de aplicações | Vista general de aplicaciones

		Fine finishing	Finishing	Medium	Roughing	Heavy roughing
N			LN 	NF ^{NEW} 		
				PCD		
	7°		Uncoated Grades			
			PH0910 N01-N20	PDP410 ^{PCD} N01-N30		
		Continuous cut ←			→ Interrupted cut	

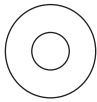
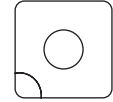
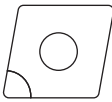
		Fine finishing	Finishing	Medium	Roughing	Heavy roughing	
S		FS 	FM 	LM 	MM 	GS ^{NEW} 	
		BO 	FW 	MW 			
	5° & 7°			wiper	wiper		
		PVD Grades					
		PH7910 S05-S10	PHH910 ^{NEW} S10-S25	PH7920 S10-S25	PHH920 ^{NEW} S10-S25		
		Continuous cut ←			→ Interrupted cut		

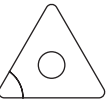
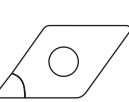
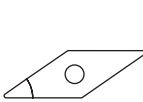
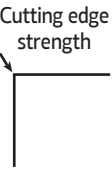
INSERT SHAPE SELECTION

Seleção de geometria para pastilha | Selección de geometria para plaquita

Shape angle		90°	80°	80°	60°	55°	35°	
Geometry shape code	R	S	C	W	T	D	V	
Geometry shape design								
Cutting edge strength								Accessibility 
Vibration tendency								Less power consumption Pc (kW) 

INSERT SHAPE

The insert shape should be selected relative to the entering angle accessibility from tools requirements.

The largest possible nose angle should be selected to provide insert strength and reliability, however, this has to be balanced against the cut variation need to be performed.

A large nose angle is strong, but requires more machine power and has a higher tendency for vibration.















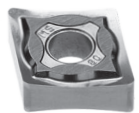





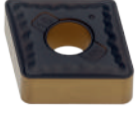





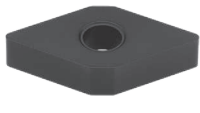
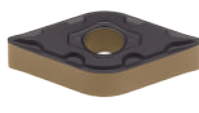

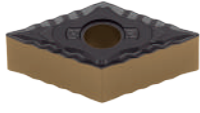

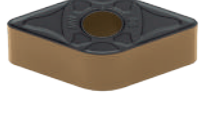

A small nose angle is weaker and has a small cutting edge engagement, both of which can make it more sensitive to the heat effects.

Scale 1: indicates the cutting edge strength. The inserts to the left have larger nose angles and are correspondingly stronger. The right hand inserts have better versatility and accessibility.

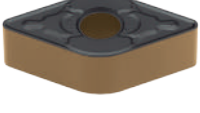



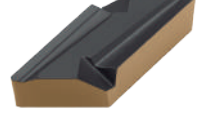
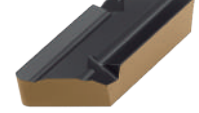

















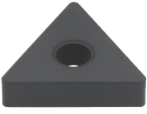









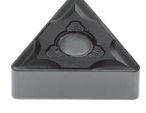

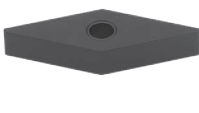
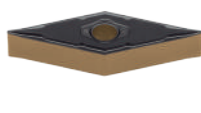
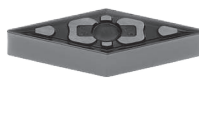

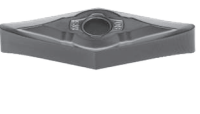

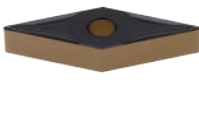

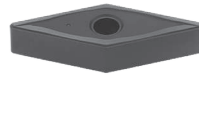
Scale 2: indicates that vibration tendencies increase to the left side, while power requirements decrease to the right.

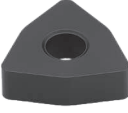
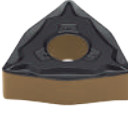
NEGATIVE TURNING INSERTS OVERVIEW

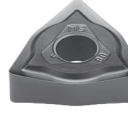

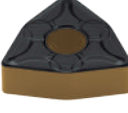

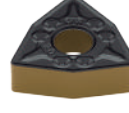





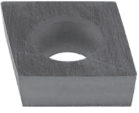





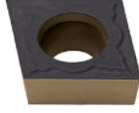
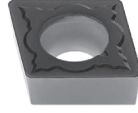
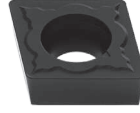
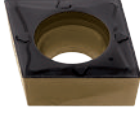

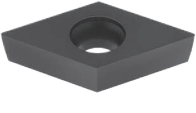





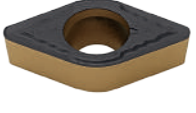



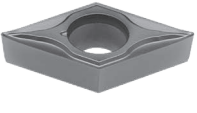
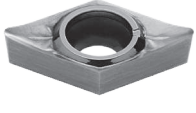





TURNING
Insert selection
Overview
Negative inserts
Positive inserts
PCBN & PCD inserts
Heavy turning
External Toolholders
Internal Toolholders
Automatic Lathes
Spare Parts
Technical Data

<p>CNMA</p>  <p>Roughing</p> <p>Page C - 388 Rhombic 80°</p>	<p>CNMG-MF</p>  <p>Finishing</p> <p>Page C - 388 Rhombic 80°</p>	<p>CNMG-SF</p>  <p>Medium to Finishing</p> <p>Page C - 388 Rhombic 80°</p>	<p>CNMG-LC</p>  <p>Medium to Finishing</p> <p>Page C - 388 Rhombic 80°</p>	<p>CNMG-MS</p>  <p>Medium</p> <p>Page C - 388 Rhombic 80°</p>	<p>CNMG-GS</p>  <p>Medium</p> <p>Page C - 388 Rhombic 80°</p>
<p>CNMG-MR</p>  <p>Medium</p> <p>Page C - 390 Rhombic 80°</p>	<p>CNMG-PM</p>  <p>Medium</p> <p>Page C - 390 Rhombic 80°</p>	<p>CNMG-ST</p>  <p>Medium</p> <p>Page C - 390 Rhombic 80°</p>	<p>CNMG-MW</p>  <p>Medium wiper</p> <p>Page C - 390 Rhombic 80°</p>	<p>CNMG-SS</p>  <p>Roughing to Medium</p> <p>Page C - 392 Rhombic 80°</p>	<p>CNMG-MA</p>  <p>Medium to Roughing</p> <p>Page C - 392 Rhombic 80°</p>
<p>CNMG-HR</p>  <p>Roughing</p> <p>Page C - 392 Rhombic 80°</p>	<p>CNMM-RP</p>  <p>Roughing</p> <p>Page C - 394 Rhombic 80°</p>	<p>CNMG-GR</p>  <p>Roughing</p> <p>Page C - 394 Rhombic 80°</p>	<p>CNMM-HY</p>  <p>Heavy to Roughing</p> <p>Page C - 394 Rhombic 80°</p>	<p>CNMM-HZ</p>  <p>Heavy to Roughing</p> <p>Page C - 394 Rhombic 80°</p>	
<p>DNMA</p>  <p>Roughing</p> <p>Page C - 396 Rhombic 55°</p>	<p>DNMG-MF</p>  <p>Finishing</p> <p>Page C - 396 Rhombic 55°</p>	<p>DNMG-SF</p>  <p>Medium to Finishing</p> <p>Page C - 396 Rhombic 55°</p>	<p>DNMG-LC</p>  <p>Medium to Finishing</p> <p>Page C - 396 Rhombic 55°</p>	<p>DNMG-MS</p>  <p>Medium</p> <p>Page C - 398 Rhombic 55°</p>	<p>DNMG-GS</p>  <p>Medium</p> <p>Page C - 398 Rhombic 55°</p>
<p>DNMG-MR</p>  <p>Medium</p> <p>Page C - 398 Rhombic 55°</p>	<p>DNMG-PM</p>  <p>Medium</p> <p>Page C - 398 Rhombic 55°</p>	<p>DNMG-ST</p>  <p>Medium</p> <p>Page C - 400 Rhombic 55°</p>	<p>DNMG-MW</p>  <p>Medium wiper</p> <p>Page C - 402 Rhombic 55°</p>	<p>DNMG-SS</p>  <p>Roughing to Medium</p> <p>Page C - 402 Rhombic 55°</p>	<p>DNMG-HR</p>  <p>Roughing</p> <p>Page C - 402 Rhombic 55°</p>
<p>DNMM-RP</p>  <p>Roughing</p> <p>Page C - 402 Rhombic 55°</p>	<p>DNMX-02</p>  <p>Medium to Finishing</p> <p>Page C - 402 Rhombic 55°</p>	<p>DNMX-03</p>  <p>Medium</p> <p>Page C - 402 Rhombic 55°</p>	<p>DNMX-01</p>  <p>Roughing to Medium</p> <p>Page C - 402 Rhombic 55°</p>		
<p>KNUX-01</p>  <p>Finishing</p> <p>Page C - 404 Parallelogram 55°</p>	<p>KNUX-02</p>  <p>Medium</p> <p>Page C - 404 Parallelogram 55°</p>				
<p>RNMG-ST</p>  <p>Medium</p> <p>Page C - 406 Round R°</p>					

















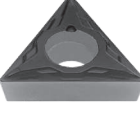



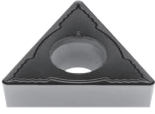
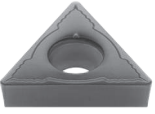

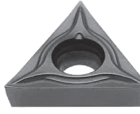



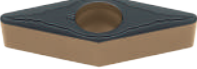

Vista genérica de pastilhas de torneamento negativas
 Vista general de plaquitas de torneado negativas

<p>SNMA</p>  <p>Roughing</p> <p>Page C - 408 Square 90°</p>	<p>SNMG-MF</p>  <p>Finishing</p> <p>Page C - 408 Square 90°</p>	<p>SNMG-SF</p>  <p>Medium to Finishing</p> <p>Page C - 408 Square 90°</p>	<p>SNMG-GS NEW</p>  <p>Medium</p> <p>Page C - 408 Square 90°</p>	<p>SNMG-MR</p>  <p>Medium</p> <p>Page C - 408 Square 90°</p>	<p>SNMG-PM</p>  <p>Medium</p> <p>Page C - 408 Square 90°</p>
<p>SNMG-ST</p>  <p>Medium</p> <p>Page C - 410 Square 90°</p>	<p>SNMG-SS</p>  <p>Roughing to Medium</p> <p>Page C - 410 Square 90°</p>	<p>SNMG-HR</p>  <p>Roughing</p> <p>Page C - 410 Square 90°</p>	<p>SNMM-RP</p>  <p>Roughing</p> <p>Page C - 410 Square 90°</p>	<p>SNMM-HY</p>  <p>Heavy to Roughing</p> <p>Page C - 412 Square 90°</p>	<p>SNMM-HZ</p>  <p>Heavy to Roughing</p> <p>Page C - 412 Square 90°</p>
<p>TNMA</p>  <p>Roughing</p> <p>Page C - 414 Triangular 60°</p>	<p>TNMG-MF</p>  <p>Finishing</p> <p>Page C - 414 Triangular 60°</p>	<p>TNMG-SF</p>  <p>Medium to Finishing</p> <p>Page C - 414 Triangular 60°</p>	<p>TNMG-LC</p>  <p>Medium to Finishing</p> <p>Page C - 414 Triangular 60°</p>	<p>TNMG-MS</p>  <p>Medium</p> <p>Page C - 414 Triangular 60°</p>	<p>TNMG-GS NEW</p>  <p>Medium</p> <p>Page C - 414 Triangular 60°</p>
<p>TNMG-MR</p>  <p>Medium</p> <p>Page C - 416 Triangular 60°</p>	<p>TNMG-PM</p>  <p>Medium</p> <p>Page C - 416 Triangular 60°</p>	<p>TNMG-ST</p>  <p>Medium</p> <p>Page C - 416 Triangular 60°</p>	<p>TNMG-MW</p>  <p>Medium wiper</p> <p>Page C - 418 Triangular 60°</p>	<p>TNMG-SS</p>  <p>Roughing to Medium</p> <p>Page C - 418 Triangular 60°</p>	<p>TNMG-HR</p>  <p>Roughing</p> <p>Page C - 418 Triangular 60°</p>
<p>TNMX-01</p>  <p>Medium to Finishing</p> <p>Page C - 418 Triangular 60°</p>		<p>VNMA</p>  <p>Roughing</p> <p>Page C - 420 Rhombic 35°</p>	<p>VNMG-MF</p>  <p>Finishing</p> <p>Page C - 420 Rhombic 35°</p>	<p>VNMG-SF</p>  <p>Medium to Finishing</p> <p>Page C - 420 Rhombic 35°</p>	<p>VNMG-LC</p>  <p>Medium to Finishing</p> <p>Page C - 420 Rhombic 35°</p>
<p>VNMG-MS</p>  <p>Medium</p> <p>Page C - 420 Rhombic 35°</p>	<p>VNMG-GS NEW</p>  <p>Medium</p> <p>Page C - 420 Rhombic 35°</p>	<p>VNMG-MR</p>  <p>Medium</p> <p>Page C - 420 Rhombic 35°</p>	<p>VNMG-PM</p>  <p>Medium</p> <p>Page C - 420 Rhombic 35°</p>	<p>VNMG-ST</p>  <p>Medium</p> <p>Page C - 420 Rhombic 35°</p>	<p>VNMG-SS</p>  <p>Roughing to Medium</p> <p>Page C - 420 Rhombic 35°</p>
<p>WNMA</p>  <p>Roughing</p> <p>Page C - 422 Trigon 80°</p>	<p>WNMG-MF</p>  <p>Finishing</p> <p>Page C - 422 Trigon 80°</p>	<p>WNMG-SF</p>  <p>Medium to Finishing</p> <p>Page C - 422 Trigon 80°</p>	<p>WNMG-LC</p>  <p>Medium to Finishing</p> <p>Page C - 422 Trigon 80°</p>	<p>WNMG-MS</p>  <p>Medium</p> <p>Page C - 422 Trigon 80°</p>	<p>WNMG-GS NEW</p>  <p>Medium</p> <p>Page C - 422 Trigon 80°</p>
<p>WNMG-MR</p>  <p>Medium</p> <p>Page C - 424 Trigon 80°</p>	<p>WNMG-PM</p>  <p>Medium</p> <p>Page C - 424 Trigon 80°</p>	<p>WNMG-ST</p>  <p>Medium</p> <p>Page C - 424 Trigon 80°</p>	<p>WNMG-MW</p>  <p>Medium wiper</p> <p>Page C - 424 Trigon 80°</p>	<p>WNMG-SS</p>  <p>Roughing to Medium</p> <p>Page C - 424 Trigon 80°</p>	<p>WNMG-HR</p>  <p>Roughing</p> <p>Page C - 424 Trigon 80°</p>

POSITIVE TURNING INSERTS OVERVIEW

TURNING	CCMW	CCMT-FP	CCMT-BO	CCMT-FM	CCMT-FK	CCMT-FW	
							
	Finishing	Finishing	Finishing	Finishing	Finishing	Finishing wiper	
	Page C - 426 Rhombic 80°	Page C - 426 Rhombic 80°	Page C - 426 Rhombic 80°	Page C - 426 Rhombic 80°	Page C - 426 Rhombic 80°	Page C - 428 Rhombic 80°	
	CCMT-LM	CCMT-MP	CCMT-MM	CCMT-MK	CCMT-MW		
							
	Medium to Finishing	Medium	Medium	Medium	Medium to Finishing wiper		
	Page C - 428 Rhombic 80°	Page C - 428 Rhombic 80°	Page C - 428 Rhombic 80°	Page C - 428 Rhombic 80°	Page C - 428 Rhombic 80°		
	CCGT-FS	CCGT-LN					
							
Finishing to Fine finishing	Medium to Finishing						
Page C - 430 Rhombic 80°	Page C - 430 Rhombic 80°						
Positive inserts	DCMW	DCMT-FP	DCMT-FM	DCMT-FK	DCMT-FW	DCMT-LM	
							
	Finishing	Finishing	Finishing	Finishing	Finishing wiper	Medium to Finishing	
	Page C - 432 Rhombic 55°	Page C - 432 Rhombic 55°	Page C - 432 Rhombic 55°	Page C - 432 Rhombic 55°	Page C - 432 Rhombic 55°	Page C - 432 Rhombic 55°	
	DCMT-MP	DCMT-MM	DCMT-MK	DCMT-MW	DCGT-FS	DCGT-LN	
							
	Medium	Medium	Medium	Medium to Finishing wiper	Finishing to Fine finishing	Medium to Finishing	
	Page C - 432 Rhombic 55°	Page C - 434 Rhombic 55°	Page C - 434 Rhombic 55°	Page C - 434 Rhombic 55°	Page C - 434 Rhombic 55°	Page C - 434 Rhombic 55°	
	External Toolholders	RCMT-GS NEW	RCMT-CP	RCMT-ST	RCMT-RF	RCMT-RM	
							
Medium		Medium	Roughing to Medium	Roughing to Medium	Roughing to Medium		
Page C - 436 Round R°		Page C - 436 Round R°	Page C - 436 Round R°	Page C - 436 Round R°	Page C - 436 Round R°		
RCMX-ST		RCMX-RM	RCMX-RR		RCGT-LN		
							
Roughing to Medium		Roughing to Medium	Roughing to Medium		Finishing to Fine finishing		
Page C - 436 Round R°		Page C - 436 Round R°	Page C - 436 Round R°		Page C - 438 Round R°		
Spare Parts		SCMW	SCMT-FP	SCMT-FM	SCMT-FK	SCMT-MP	SCMT-MM
							
	Finishing	Finishing	Finishing	Finishing	Medium	Medium	
	Page C - 440 Square 90°	Page C - 440 Square 90°	Page C - 440 Square 90°	Page C - 440 Square 90°	Page C - 440 Square 90°	Page C - 440 Square 90°	

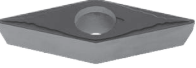
Vista genérica de pastilhas de torneamento positivas
 Vista general de plaquitas de torneado positivas

<p>SCMT-MK</p>  <p>Medium</p> <p>Page C - 440 Square 90°</p>	<p>SCGT-LN</p>  <p>Medium to Finishing</p> <p>Page C - 440 Square 90°</p>		<p>SPUN</p>  <p>Medium to Finishing</p> <p>Page C - 442 Square 90°</p>	<p>SPMR-12</p>  <p>Finishing to Fine finishing</p> <p>Page C - 442 Square 90°</p>	<p>SPMR-13</p>  <p>Medium</p> <p>Page C - 442 Square 90°</p>
<p>TCMW</p>  <p>Finishing</p> <p>Page C - 444 Triangular 60°</p>	<p>TCMT-FP</p>  <p>Finishing</p> <p>Page C - 444 Triangular 60°</p>	<p>TCMT-FM</p>  <p>Finishing</p> <p>Page C - 444 Triangular 60°</p>	<p>TCMT-FK</p>  <p>Finishing</p> <p>Page C - 446 Triangular 60°</p>	<p>TCMT-FW</p>  <p>Finishing wiper</p> <p>Page C - 446 Triangular 60°</p>	<p>TCMT-MP</p>  <p>Medium</p> <p>Page C - 446 Triangular 60°</p>
<p>TCMT-MM</p>  <p>Medium</p> <p>Page C - 448 Triangular 60°</p>	<p>TCMT-MK</p>  <p>Medium</p> <p>Page C - 448 Triangular 60°</p>	<p>TCMT-MW</p>  <p>Medium to Finishing wiper</p> <p>Page C - 448 Triangular 60°</p>		<p>TCGT-FS</p>  <p>Finishing to Fine finishing</p> <p>Page C - 450 Triangular 60°</p>	<p>TCGT-LN</p>  <p>Medium to Finishing</p> <p>Page C - 450 Triangular 60°</p>
<p>TPUN</p>  <p>Medium to Finishing</p> <p>Page C - 452 Triangular 60°</p>	<p>TPMR-12</p>  <p>Finishing to Fine finishing</p> <p>Page C - 452 Triangular 60°</p>	<p>TPMR-13</p>  <p>Medium</p> <p>Page C - 452 Triangular 60°</p>			
<p>VBMW</p>  <p>Finishing</p> <p>Page C - 454 Rhombic 35°</p>	<p>VBMT-FP</p>  <p>Finishing</p> <p>Page C - 454 Rhombic 35°</p>	<p>VBMT-FM</p>  <p>Finishing</p> <p>Page C - 454 Rhombic 35°</p>	<p>VBMT-FK</p>  <p>Finishing</p> <p>Page C - 454 Rhombic 35°</p>	<p>VBMT-MP</p>  <p>Medium</p> <p>Page C - 454 Rhombic 35°</p>	<p>VBMT-MM</p>  <p>Medium</p> <p>Page C - 454 Rhombic 35°</p>
<p>VBMT-MK</p>  <p>Medium</p> <p>Page C - 454 Rhombic 35°</p>					
<p>VCMW</p>  <p>Finishing</p> <p>Page C - 456 Rhombic 35°</p>	<p>VCMT-FP</p>  <p>Finishing</p> <p>Page C - 456 Rhombic 35°</p>	<p>VCMT-FM</p>  <p>Finishing</p> <p>Page C - 456 Rhombic 35°</p>	<p>VCMT-FK</p>  <p>Finishing</p> <p>Page C - 456 Rhombic 35°</p>	<p>VCMT-MP</p>  <p>Medium</p> <p>Page C - 456 Rhombic 35°</p>	<p>VCMT-MM</p>  <p>Medium</p> <p>Page C - 456 Rhombic 35°</p>
<p>VCMT-MK</p>  <p>Medium</p> <p>Page C - 456 Rhombic 35°</p>		<p>VCGT-FS</p>  <p>Finishing to Fine finishing</p> <p>Page C - 458 Rhombic 35°</p>	<p>VCGT-LN</p>  <p>Medium to Finishing</p> <p>Page C - 458 Rhombic 35°</p>		

DOMX - THE REVOLUTION IN HRSA MEDIUM TO ROUGH TURNING

A revolução em torneamento de materiais termorresistentes | La revolución en el torneado de materiales exóticos

Designed especially for HRSA, the new DOMX combined with the latest PHH technology, offers exceptional performance in exotic materials machining. When your material has high Ni or Co content DOMX is the choice!

- 🔗 First choice for **HRSA** medium to rough turning;
- 🔗 **4 positive cutting edges on double sided negative insert.**

DOMX[®]

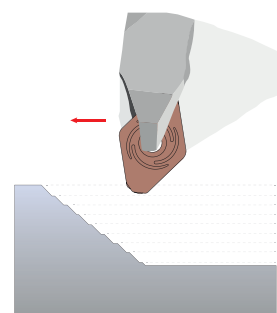

- 🔗 Machine at 45° with a 93° holder;
- 🔗 **Up to +140% tool life improvement.**

APPLICATION
GUIDE



CHECK THE
VIDEO



Inserts Pastilhas Plaquetas	(1) Geometry code	(2) Grade code	S		Dimensions (mm) Dimensões (mm) Dimensiones (mm)				Cutting Conditions Condições de Corte Condiciones de Corte					Technical drawing Desenho técnico Dibujo técnico	
			PVD		D	S	Re	d1	ap (mm)	Min	Max	fn (mm/rev)	Min		Max
			X6	Y3											
	1124595	DOMX 1506R1-GS			12,70	6,35	0,80	5,16	1,50	0,20	2,00	0,30	0,20	0,50	
	1124493	DOMX 1506L1-GS			12,70	6,35	0,80	5,16	1,50	0,20	2,00	0,30	0,20	0,50	

This new insert (DOMX) can be used in several types of turning operations, from facing, external/internal turning to case and ring machining as seen in the examples below:

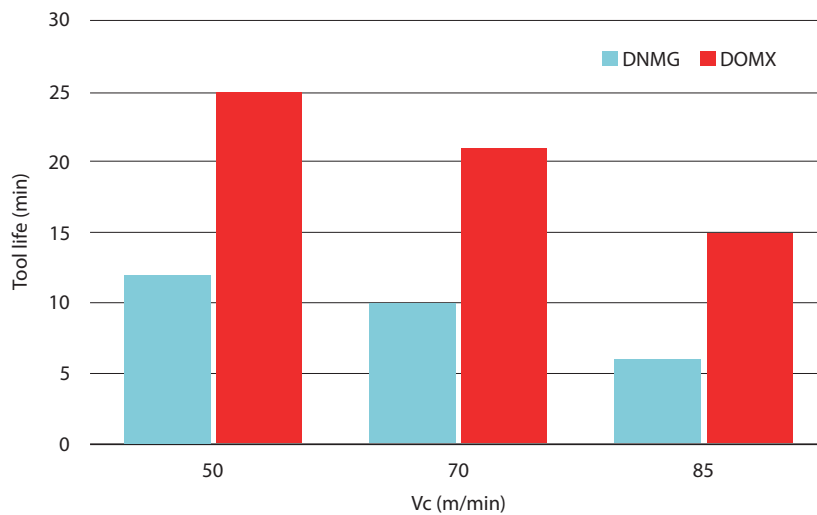
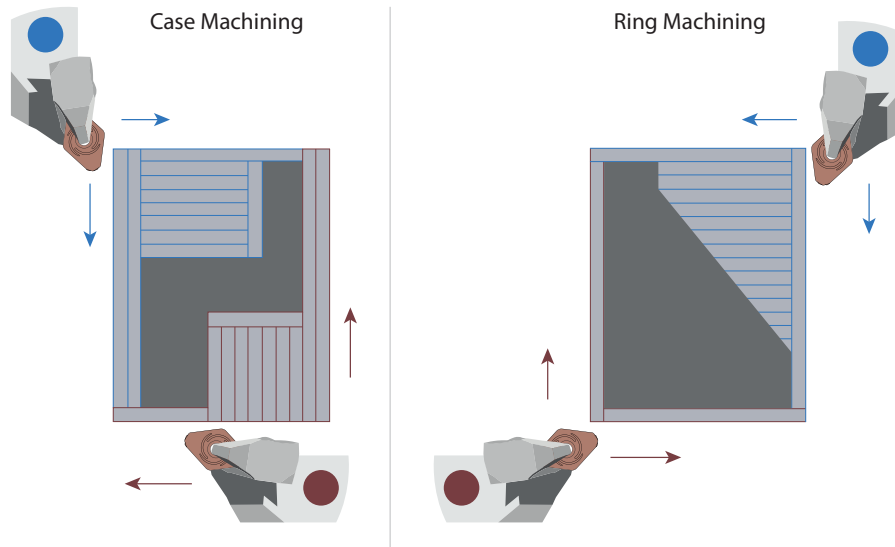





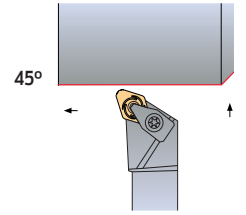
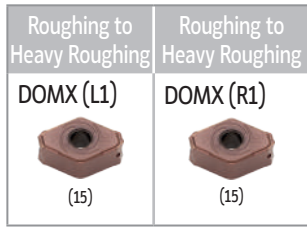

Tool life test – Inconel 625, ap 1,5mm, fn 0.15mm/r

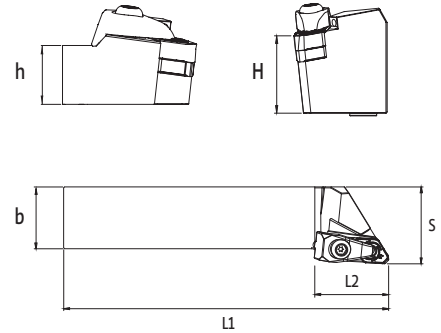
(D) DIMPLE LOCK TOOLHOLDERS



Axial: -6,25°
Radial: -6,75°











Order Code		Reference	Dimensions (mm)					Insert	Kg	Stock	
R	L		H=h	b	L1	L2	S			R	L
182000900	182001200	DDJN R/L 2020 K15-A-DX1	20	20	125	42	25	DOMX 1506..	0,40		
182001000	182001300	DDJN R/L 2525 M15-A-DX1	25	25	150	42	32	DOMX 1506..	0,75		
182001100	182001400	DDJN R/L 3232 P15-A-DX1	32	32	170	42	40	DOMX 1506..	1,30		

 Stock item | Produto de stock | Itens de stock



 Available under request | Disponível sobre consulta
Disponibile bajo consulta

Insert order code = (1) Geometry Code + (2) Grade Code







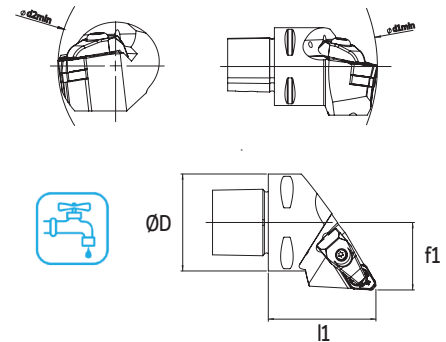
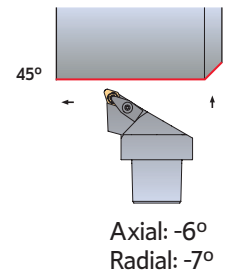

SPARE PARTS || Complementos | Repuestos

Cutter Reference	Shim R	Shim L	Spring	Clamp	Clamp Screw	Wrench	Screw 1	Screw 2	Screw Allen
DDJN R/L 2020 K15-A-DX1									
DDJN R/L 2525 M15-A-DX1	CD150503	CD150502	M09513	GA07002	D0602900	SS40	H0600475	H1000875	T1000875
DDJN R/L 3232 P15-A-DX1	CD150503	CD150502	M09513	GA07002	D0602900	SS40	-	H1000875	-

(D) DIMPLE LOCK TOOLHOLDERS

Roughing to Heavy Roughing	Roughing to Heavy Roughing
DOMX (L1)	DOMX (R1)
	
(15)	(15)









Order Code		Reference	Dimensions (mm)					Insert	Kg	Stock	
R	L		ØD	Ød1 min	Ød2 min	f1	l1			R	L
182000100	182000500	PSC40-DDJNR/L27055-15-DX1	40	110	145	27	55	DOMX 1506..	0,42		
182000200	182000600	PSC50-DDJNR/L35060-15-DX1	50	110	165	35	60	DOMX 1506..	0,80		
182000300	182000700	PSC63-DDJNR/L45065-15-DX1	63	110	190	45	65	DOMX 1506..	1,10		
182000400	182000800	PSC80-DDJNR/L55080-15-DX1	80	110	250	55	80	DOMX 1506..	2,74		

 Stock item | Produto de stock | Itens de stock

 Available under request | Disponível sobre consulta
Disponibile bajo consulta







Insert order code = (1) Geometry Code + (2) Grade Code

SPARE PARTS || Complementos | Repuestos

Cutter Reference	Shim R	Shim L	Shim Screw	Spring	Clamp	Clamp Screw	Wrench
PSC40-DDJNR/L27055-15-DX1							
PSC50-DDJNR/L35060-15-DX1	CD150503	CD150502	T06010000	M09513	GA07002	D0602900	SS40
PSC63-DDJNR/L45065-15-DX1	CD150503	CD150502	T06010000	M09513	GA07002	D0602900	SS40
PSC80-DDJNR/L55080-15-DX1	CD150503	CD150502	T06010000	M09513	GA07002	D0602900	SS40

CN = RHOMBIC 80° NEGATIVE

RÔMBICA 80° NEGATIVA | RÓMBICA 80° NEGATIVA

			P								M				K			N	S									
			CVD					PVD			CVD				PVD		CVD	UNC	PVD									
		(2) Grade code	T6	L7	R2	L8	R3	L9	V5	G1	G4	U4	U5	V6	G1	X6	G4	Y3	L5	L6	L9	10	G1	X6	G4	Y3		
Inserts Pastilhas Plaquitas	(1) Geometry code	ISO Reference	PHG105	PH5115	PHG115	PH5125	PHG125	PH5740	PHG140	PH7910	PH7920	PHS215	PHS225	PHS240	PH7910	PHH910	PH7920	PHH920	PH5705	PH5320	PH5740	PH0910	PH7910	PHH910	PH7920	PHH920		
 CNMA Roughing	1120219	CNMA 120404																	⊗	⊗								
	1120220	CNMA 120408																		⊗	⊗							
	1120221	CNMA 120412																		⊗	⊗							
	1120223	CNMA 120416																		⊗	⊗							
	1120224	CNMA 160608																		⊗	⊗							
	1120225	CNMA 160612																		⊗	⊗							
	1121470	CNMA 160616																		⊗	⊗							
	1120226	CNMA 190612																		⊗	⊗							
	1120227	CNMA 190616																		⊗	⊗							
	1121471	CNMA 190624																		⊗								
 CNMG-MF Finishing	1121472	CNMG 090304-MF		⊗	⊗	⊗	⊗																					
	1121318	CNMG 090308-MF		⊗	⊗	⊗	⊗																					
	1121320	CNMG 09T304-MF		⊗	⊗																							
	1121317	CNMG 09T308-MF		⊗	⊗																							
	1121478	CNMG 120404-MF	⊗		⊗		⊗			⊗																		
	1121480	CNMG 120408-MF			⊗		⊗			⊗																		
1121482	CNMG 120412-MF		⊗	⊗	⊗	⊗																						
 CNMG-SF Medium to Finishing	1123747	CNMG 120404-SF										⊗	⊗		⊗	⊗	⊗						⊗	⊗	⊗	⊗		
	1123717	CNMG 120408-SF										⊗	⊗		⊗	⊗	⊗						⊗	⊗	⊗	⊗		
	1123748	CNMG 120412-SF										⊗	⊗		⊗	⊗	⊗						⊗	⊗	⊗	⊗		
 CNMG-LC Medium to Finishing	1122024	CNMG 120404-LC			⊗	⊗	⊗																					
	1122021	CNMG 120408-LC	⊗		⊗	⊗	⊗																					
	1124029	CNMG 120412-LC		⊗	⊗	⊗	⊗																					
 CNMG-MS Medium	1121479	CNMG 120404-MS														⊗	⊗	⊗				⊗	⊗	⊗	⊗	⊗		
	1121481	CNMG 120408-MS														⊗	⊗	⊗				⊗	⊗	⊗	⊗	⊗		
	1121483	CNMG 120412-MS														⊗	⊗	⊗				⊗	⊗	⊗	⊗	⊗		
	1121486	CNMG 120416-MS															⊗	⊗				⊗			⊗	⊗		
 CNMG-GS Medium to Finishing	1124514	CNMG 120404-GS														⊗		⊗					⊗	⊗	⊗	⊗		
	1124502	CNMG 120408-GS														⊗		⊗					⊗	⊗	⊗	⊗		
	1124515	CNMG 120412-GS														⊗		⊗					⊗	⊗	⊗	⊗		

⊗ First choice | 1ª Escolha | 1ª Opción

⊗ Stock available until sold out | Stock disponível até acabar o stock | Stock disponible hasta acabar el stock

Insert Order Code: (1) Geometry code + (2) Grade code

⊗ Stock Items | Itens de stock

○ Available under request | Disponível sob consulta | Disponible bajo consulta

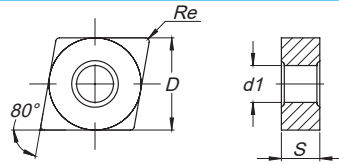

ISO Reference	ANSI Reference	Dimensions (mm) Dimensões (mm) Dimensiones (mm)				Cutting Conditions Condições de Corte Condiciones de Corte					
		D	S	Re	d1	ap (mm)	Min	Max	fn (mm/rev)	Min	Max
CNMA 120404	CNMA 431	12,700	4,76	0,40	5,16	2,50	0,20	5,00	0,20	0,10	0,30
CNMA 120408	CNMA 432	12,700	4,76	0,80	5,16	4,00	0,20	8,00	0,35	0,15	0,60
CNMA 120412	CNMA 433	12,700	4,76	1,20	5,16	4,00	0,30	8,00	0,45	0,20	0,80
CNMA 120416	CNMA 434	12,700	4,76	1,60	5,16	4,00	0,30	8,00	0,55	0,20	1,00
CNMA 160608	CNMA 542	15,875	6,35	0,80	6,35	5,00	0,30	10,00	0,45	0,20	0,80
CNMA 160612	CNMA 543	15,875	6,35	1,20	6,35	5,00	0,30	10,00	0,45	0,20	0,80
CNMA 160616	CNMA 544	15,875	6,35	1,60	6,35	5,00	0,30	10,00	0,55	0,20	1,00
CNMA 190612	CNMA 643	19,050	6,35	1,20	7,94	6,00	0,30	12,00	0,45	0,20	0,80
CNMA 190616	CNMA 644	19,050	6,35	1,60	7,94	6,00	0,30	12,00	0,55	0,20	1,00
CNMA 190624	CNMA 646	19,050	6,35	2,40	7,94	6,00	0,40	12,00	0,60	0,20	1,40
CNMG 090304-MF	CNMG 321-MF	9,525	3,18	0,40	3,81	0,50	0,10	1,50	0,15	0,05	0,25
CNMG 090308-MF	CNMG 322-MF	9,525	3,18	0,80	3,81	0,55	0,10	1,50	0,20	0,10	0,40
CNMG 09T304-MF	CNMG 32.51-MF	9,525	3,97	0,40	3,81	0,50	0,10	1,50	0,15	0,05	0,25
CNMG 09T308-MF	CNMG 32.52-MF	9,525	3,97	0,80	3,81	0,55	0,10	1,50	0,20	0,10	0,40
CNMG 120404-MF	CNMG 431-MF	12,700	4,76	0,40	5,16	0,80	0,20	1,50	0,15	0,05	0,25
CNMG 120408-MF	CNMG 432-MF	12,700	4,76	0,80	5,16	1,00	0,25	1,50	0,20	0,10	0,40
CNMG 120412-MF	CNMG 433-MF	12,700	4,76	1,20	5,16	1,25	0,50	2,50	0,25	0,15	0,50
CNMG 120404-SF	CNMG 431-SF	12,700	4,76	0,40	5,16	1,50	0,60	3,00	0,15	0,10	0,23
CNMG 120408-SF	CNMG 432-SF	12,700	4,76	0,80	5,16	1,50	0,60	3,00	0,25	0,12	0,38
CNMG 120412-SF	CNMG 433-SF	12,700	4,76	1,20	5,16	1,50	0,60	3,00	0,35	0,15	0,55
CNMG 120404-LC	CNMG 431-LC	12,700	4,76	0,40	5,16	1,00	0,40	2,50	0,10	0,07	0,30
CNMG 120408-LC	CNMG 432-LC	12,700	4,76	0,80	5,16	1,50	0,40	2,50	0,15	0,10	0,40
CNMG 120412-LC	CNMG 433-LC	12,700	4,76	1,20	5,16	1,50	0,40	2,50	0,20	0,15	0,40
CNMG 120404-MS	CNMG 431-MS	12,700	4,76	0,40	5,16	1,50	0,20	3,60	0,15	0,10	0,20
CNMG 120408-MS	CNMG 432-MS	12,700	4,76	0,80	5,16	2,00	0,30	3,60	0,25	0,10	0,40
CNMG 120412-MS	CNMG 433-MS	12,700	4,76	1,20	5,16	2,40	0,40	3,60	0,30	0,15	0,60
CNMG 120416-MS	CNMG 434-MS	12,700	4,76	1,60	5,16	2,40	0,40	3,60	0,40	0,15	0,80
CNMG 120404-GS	CNMG 431-GS	12,700	4,76	0,40	5,16	1,50	0,15	2,50	0,20	0,10	0,30
CNMG 120408-GS	CNMG 432-GS	12,700	4,76	0,80	5,16	2,00	0,20	3,00	0,25	0,10	0,35
CNMG 120412-GS	CNMG 433-GS	12,700	4,76	1,20	5,16	2,50	0,30	4,00	0,30	0,10	0,45

CN = RHOMBIC 80° NEGATIVE

RÔMBICA 80° NEGATIVA | RÓMBICA 80° NEGATIVA

			P								M				K			N	S							
			CVD					PVD			CVD				PVD		CVD	UNC	PVD							
		(2) Grade code	T6	L7	R2	L8	R3	L9	V5	G1	G4	U4	U5	V6	G1	X6	G4	Y3	L5	L6	L9	10	G1	X6	G4	Y3
Inserts Pastilhas Plaquitas	(1) Geometry code	ISO Reference	PHG105	PH5115	PHG115	PH5125	PHG125	PH5740	PHG140	PH7910	PH7920	PHS215	PHS225	PHS240	PH7910	PHH910	PH7920	PHH920	PH5705	PH5320	PH5740	PH0910	PH7910	PHH910	PH7920	PHH920
 Medium	1121473	CNMG 090304-MR		⊗	⊗		⊗																			
	1121293	CNMG 090308-MR		⊗	⊗		⊗																			
	1121180	CNMG 120404-MR			⊗		⊗		⊗																	
	1121174	CNMG 120408-MR			⊗	⊗	⊗		⊗																	
	1121198	CNMG 120412-MR		⊗	⊗		⊗	⊗	⊗																	
	1121485	CNMG 120416-MR		⊗	⊗	⊗	⊗	⊗	⊗																	
	1121239	CNMG 160608-MR			⊗		⊗		⊗																	
	1121355	CNMG 160612-MR			⊗		⊗		⊗																	
	1121490	CNMG 160616-MR			⊗	⊗	⊗	⊗	⊗																	
	1121302	CNMG 190612-MR			⊗		⊗	⊗	⊗																	
1121301	CNMG 190616-MR			⊗		⊗	⊗	⊗																		
 Medium	1123919	CNMG 120404-PM	⊗		⊗		⊗																			
	1123790	CNMG 120408-PM	⊗		⊗		⊗																			
	1123920	CNMG 120412-PM	⊗		⊗		⊗																			
	1123921	CNMG 120416-PM			⊗		⊗																			
 Medium	1121344	CNMG 120404-ST																	⊗	⊗						
	1121165	CNMG 120408-ST																		⊗	⊗					
	1121166	CNMG 120412-ST																		⊗	⊗					
	1121488	CNMG 120416-ST																		⊗	⊗					
	1121335	CNMG 160608-ST																		⊗	⊗					
	1121303	CNMG 160612-ST																		⊗	⊗					
	1121491	CNMG 160616-ST																		⊗	⊗					
	1121336	CNMG 190612-ST																		⊗	⊗					
	1121345	CNMG 190616-ST																		⊗	⊗					
	 Medium Wiper	1121339	CNMG 120408-MW			⊗		⊗	⊗	⊗											⊗	⊗				
1121191		CNMG 120412-MW		⊗	⊗		⊗	⊗	⊗												⊗	⊗				

⊗ First choice | 1ª Escolha | 1ª Opción

⊗ Stock available until sold out | Stock disponível até acabar o stock | Stock disponible hasta acabar el stock

Insert Order Code: ⁽¹⁾ Geometry code + ⁽²⁾ Grade code

⊗ Stock Items | Itens de stock

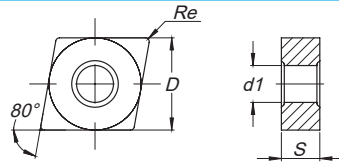

○ Available under request | Disponível sob consulta | Disponible bajo consulta



ISO Reference	ANSI Reference	Dimensions (mm) Dimensões (mm) Dimensiones (mm)				Cutting Conditions Condições de Corte Condiciones de Corte					
		D	S	Re	d1	ap (mm)	Min	Max	fn (mm/rev)	Min	Max
CNMG 090304-MR	CNMG 321-MR	9,525	3,18	0,40	3,81	2,00	0,40	4,00	0,20	0,10	0,30
CNMG 090308-MR	CNMG 322-MR	9,525	3,18	0,80	3,81	2,00	0,50	4,00	0,30	0,15	0,50
CNMG 120404-MR	CNMG 431-MR	12,700	4,76	0,40	5,16	3,00	0,40	5,50	0,20	0,10	0,30
CNMG 120408-MR	CNMG 432-MR	12,700	4,76	0,80	5,16	3,00	0,50	5,50	0,30	0,15	0,50
CNMG 120412-MR	CNMG 433-MR	12,700	4,76	1,20	5,16	3,00	0,80	5,50	0,35	0,18	0,60
CNMG 120416-MR	CNMG 434-MR	12,700	4,76	1,60	5,16	3,00	1,00	5,50	0,40	0,23	0,65
CNMG 160608-MR	CNMG 542-MR	15,875	6,35	0,80	6,35	4,00	0,50	7,20	0,30	0,15	0,50
CNMG 160612-MR	CNMG 543-MR	15,875	6,35	1,20	6,35	4,00	0,80	7,20	0,35	0,18	0,60
CNMG 160616-MR	CNMG 544-MR	15,875	6,35	1,60	6,35	4,00	1,00	7,20	0,40	0,23	0,65
CNMG 190612-MR	CNMG 643-MR	19,050	6,35	1,20	7,94	4,00	0,80	8,60	0,35	0,18	0,60
CNMG 190616-MR	CNMG 644-MR	19,050	6,35	1,60	7,94	4,00	1,00	8,60	0,40	0,23	0,65
CNMG 120404-PM	CNMG 431-PM	12,700	4,76	0,40	5,16	3,00	0,40	5,50	0,20	0,10	0,30
CNMG 120408-PM	CNMG 432-PM	12,700	4,76	0,80	5,16	3,00	0,50	5,50	0,30	0,15	0,50
CNMG 120412-PM	CNMG 433-PM	12,700	4,76	1,20	5,16	3,00	0,80	5,50	0,35	0,18	0,60
CNMG 120416-PM	CNMG 434-PM	12,700	4,76	1,60	5,16	3,00	1,00	5,50	0,40	0,23	0,65
CNMG 120404-ST	CNMG 431-ST	12,700	4,76	0,40	5,16	2,50	0,20	5,00	0,22	0,15	0,26
CNMG 120408-ST	CNMG 432-ST	12,700	4,76	0,80	5,16	3,00	0,20	6,00	0,35	0,15	0,50
CNMG 120412-ST	CNMG 433-ST	12,700	4,76	1,20	5,16	3,00	0,30	6,00	0,40	0,15	0,60
CNMG 120416-ST	CNMG 434-ST	12,700	4,76	1,60	5,16	3,00	0,30	6,00	0,45	0,20	0,70
CNMG 160608-ST	CNMG 542-ST	15,875	6,35	0,80	6,35	4,00	0,20	8,00	0,35	0,15	0,50
CNMG 160612-ST	CNMG 543-ST	15,875	6,35	1,20	6,35	4,00	0,30	8,00	0,40	0,15	0,60
CNMG 160616-ST	CNMG 544-ST	15,875	6,35	1,60	6,35	4,00	0,30	8,00	0,45	0,20	0,70
CNMG 190612-ST	CNMG 643-ST	19,050	6,35	1,20	7,94	4,50	0,30	9,00	0,40	0,15	0,60
CNMG 190616-ST	CNMG 644-ST	19,050	6,35	1,60	7,94	4,50	0,30	9,00	0,45	0,20	0,70
CNMG 120408-MW	CNMG 432-MW	12,700	4,76	0,80	5,16	3,00	0,50	5,00	0,30	0,15	0,60
CNMG 120412-MW	CNMG 433-MW	12,700	4,76	1,20	5,16	3,50	0,80	6,00	0,50	0,20	0,90

CN = RHOMBIC 80° NEGATIVE

RÔMBICA 80° NEGATIVA | RÓMBICA 80° NEGATIVA

			P								M						K			N	S							
			CVD					PVD			CVD			PVD			CVD			UNC	PVD							
		(2) Grade code	T6	L7	R2	L8	R3	L9	V5	G1	G4	U4	U5	V6	G1	X6	G4	Y3	L5	L6	L9	10	G1	X6	G4	Y3		
Inserts Pastilhas Plaquetas	(1) Geometry code	ISO Reference	PHG105	PH5115	PHG115	PH5125	PHG125	PH5740	PHG140	PH7910	PH7920	PHS215	PHS225	PHS240	PH7910	PHH910	PH7920	PHH920	PH5705	PH5320	PH5740	PH0910	PH7910	PHH910	PH7920	PHH920		
 Roughing to Medium	CNMG-SS	1121474	CNMG 090304-SS																									
		1121476	CNMG 090308-SS																									
		1121243	CNMG 120404-SS																									
		1121201	CNMG 120408-SS																									
		1121202	CNMG 120412-SS																									
		1121487	CNMG 120416-SS																									
		1121332	CNMG 160608-SS																									
		1121333	CNMG 160612-SS																									
		1121363	CNMG 190612-SS																									
		1121364	CNMG 190616-SS																									
 Medium to Roughing	CNMG-MA NEW	1124504	CNMG 160612-MA																									
		1123785	CNMG 160616-MA																									
 Roughing	CNMG-HR	1121193	CNMG 120408-HR																									
		1121192	CNMG 120412-HR																									
		1121484	CNMG 120416-HR																									
		1121331	CNMG 160608-HR																									
		1121358	CNMG 160612-HR																									
		1121489	CNMG 160616-HR																									
		1121359	CNMG 190612-HR																									
		1121360	CNMG 190616-HR																									
	1121636	CNMG 250924-HR																										

🔴 First choice | 1ª Escolha | 1ª Opción

🟡 Stock available until sold out | Stock disponible até acabar o stock | Stock disponible hasta acabar el stock

Insert Order Code: ⁽¹⁾Geometry code + ⁽²⁾Grade code

🟢 Stock Items | Itens de stock



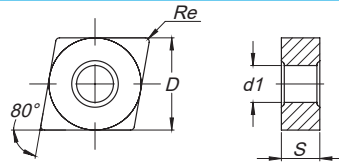

⚪ Available under request | Disponível sob consulta | Disponible bajo consulta



ISO Reference	ANSI Reference	Dimensions (mm) Dimensões (mm) Dimensiones (mm)				Cutting Conditions Condições de Corte Condiciones de Corte					
		D	S	Re	d1	ap (mm)	Min	Max	fn (mm/rev)	Min	Max
CNMG 090304-SS	CNMG 321-SS	9,525	3,18	0,40	3,81	2,00	0,50	2,50	0,20	0,10	0,25
CNMG 090308-SS	CNMG 322-SS	9,525	3,18	0,80	3,81	2,00	0,50	2,50	0,25	0,12	0,45
CNMG 120404-SS	CNMG 431-SS	12,700	4,76	0,40	5,16	3,00	0,50	5,70	0,20	0,10	0,25
CNMG 120408-SS	CNMG 432-SS	12,700	4,76	0,80	5,16	3,00	0,50	5,70	0,25	0,12	0,45
CNMG 120412-SS	CNMG 433-SS	12,700	4,76	1,20	5,16	3,00	0,50	5,70	0,30	0,15	0,60
CNMG 120416-SS	CNMG 434-SS	12,700	4,76	1,60	5,16	3,00	0,50	5,70	0,37	0,18	0,65
CNMG 160608-SS	CNMG 542-SS	15,875	6,35	0,80	6,35	4,00	0,50	7,20	0,25	0,12	0,45
CNMG 160612-SS	CNMG 543-SS	15,875	6,35	1,20	6,35	4,00	0,50	7,20	0,30	0,15	0,60
CNMG 190612-SS	CNMG 643-SS	19,050	6,35	1,20	7,94	4,00	0,50	8,50	0,30	0,15	0,60
CNMG 190616-SS	CNMG 644-SS	19,050	6,35	1,60	7,94	4,00	0,50	8,50	0,37	0,18	0,65
CNMG 160612-MA	CNMG 543-MA	15,875	6,35	1,20	6,35	4,00	1,50	8,00	0,40	0,20	0,65
CNMG 160616-MA	CNMG 544-MA	15,875	6,35	1,60	6,35	5,00	1,60	8,00	0,50	0,25	0,70
CNMG 120408-HR	CNMG 432-HR	12,700	4,76	0,80	5,16	4,00	1,00	7,00	0,35	0,20	0,55
CNMG 120412-HR	CNMG 433-HR	12,700	4,76	1,20	5,16	4,00	1,00	7,00	0,40	0,25	0,60
CNMG 120416-HR	CNMG 434-HR	12,700	4,76	1,60	5,16	4,00	1,50	7,00	0,50	0,32	0,75
CNMG 160608-HR	CNMG 542-HR	15,875	6,35	0,80	6,35	5,00	1,00	8,00	0,35	0,20	0,55
CNMG 160612-HR	CNMG 543-HR	15,875	6,35	1,20	6,35	5,00	1,00	8,00	0,40	0,25	0,60
CNMG 160616-HR	CNMG 544-HR	15,875	6,35	1,60	6,35	5,00	1,50	8,00	0,50	0,32	0,75
CNMG 190612-HR	CNMG 643-HR	19,050	6,35	1,20	7,94	5,50	2,00	10,00	0,40	0,25	0,70
CNMG 190616-HR	CNMG 644-HR	19,050	6,35	1,60	7,94	5,50	2,00	10,00	0,50	0,32	0,80
CNMG 250924-HR	CNMG 866-HR	25,400	9,52	2,40	9,12	6,00	2,00	15,00	0,60	0,40	1,00

CN = RHOMBIC 80° NEGATIVE

RÔMBICA 80° NEGATIVA | RÓMBICA 80° NEGATIVA

			P								M						K			N	S						
			CVD						PVD		CVD			PVD			CVD			UNC	PVD						
		(2) Grade code	T6	L7	R2	L8	R3	L9	V5	G1	G4	U4	U5	V6	G1	X6	G4	Y3	L5	L6	L9	10	G1	X6	G4	Y3	
Inserts Pastilhas Plaquitas	(1) Geometry code	ISO Reference	PHG105	PH5115	PHG115	PH5125	PHG125	PH5740	PHG140	PH7910	PH7920	PHS215	PHS225	PHS240	PH7910	PHH910	PH7920	PHH920	PH5705	PH5320	PH5740	PH0910	PH7910	PHH910	PH7920	PHH920	
 CNMM-RP Roughing	1124054	CNMM 160608-RP			⊗		⊗																				
	1124055	CNMM 160612-RP			⊗		⊗																				
	1124056	CNMM 160616-RP			⊗		⊗																				
CNMM-GR NEW  Roughing	1124597	CNMM 120408-GR					⊗																				
	1124596	CNMM 120412-GR					⊗																				
	1121608	CNMM 190612-HY		⊗	⊗	⊗	⊗							⊗													
CNMM-HY  Heavy to Roughing	1121252	CNMM 190616-HY			⊗	⊗	⊗							⊗													
	1121434	CNMM 190624-HY		⊗	⊗	⊗	⊗	⊗						⊗													
CNMM-HZ  Heavy to Roughing	1121248	CNMM 250924-HY		⊗	⊗	⊗	⊗	⊗						⊗													
	1121607	CNMM 190612-HZ		⊗	⊗		⊗	⊗	⊗												⊗	⊗					
	1121251	CNMM 190616-HZ			⊗		⊗	⊗	⊗												⊗	⊗					
	1121435	CNMM 190624-HZ			⊗		⊗	⊗	⊗												⊗	⊗					
1121247	CNMM 250924-HZ		⊗	⊗		⊗		⊗												⊗							

⊗ First choice | 1ª Escolha | 1ª Opción

⊗ Stock available until sold out | Stock disponível até acabar o stock | Stock disponible hasta acabar el stock

Insert Order Code: ⁽¹⁾ Geometry code + ⁽²⁾ Grade code

⊗ Stock items | Itens de stock



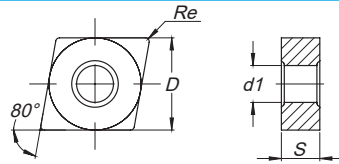

○ Available under request | Disponível sob consulta | Disponible bajo consulta



ISO Reference	ANSI Reference	Dimensions (mm) Dimensões (mm) Dimensiones (mm)				Cutting Conditions Condições de Corte Condiciones de Corte					
		D	S	Re	d1	ap (mm)	Min	Max	fn (mm/rev)	Min	Max
CNMM 160608-RP	CNMM 542-RP	15,875	6,35	0,80	6,35	3,50	1,00	8,00	0,35	0,20	0,55
CNMM 160612-RP	CNMM 543-RP	15,875	6,35	1,20	6,35	3,50	1,00	8,00	0,25	0,25	0,60
CNMM 160616-RP	CNMM 544-RP	15,875	6,35	1,60	6,35	3,50	1,50	8,00	0,50	0,32	0,75
CNMM 190612-RP	CNMM 643-RP	19,050	6,35	1,20	7,94	5,50	2,00	10,00	0,40	0,25	0,70
CNMM 190616-RP	CNMM 644-RP	19,050	6,35	1,60	7,94	5,50	2,00	10,00	0,50	0,32	0,80
CNMM 190624-RP	CNMM 646-RP	19,050	6,35	2,40	7,94	6,00	2,00	12,00	0,60	0,35	1,20
CNMM 120408-GR	CNMM 432-GR	12,700	4,76	0,80	5,16	4,00	1,00	8,00	0,40	0,25	0,65
CNMM 120412-GR	CNMM 433-GR	12,700	4,76	1,20	5,16	5,00	1,50	8,50	0,50	0,30	0,70
CNMM 190612-HY	CNMM 643-HY	19,050	6,35	1,20	7,94	6,00	2,00	12,00	0,50	0,35	0,80
CNMM 190616-HY	CNMM 644-HY	19,050	6,35	1,60	7,94	6,00	2,00	12,00	0,60	0,35	1,00
CNMM 190624-HY	CNMM 646-HY	19,050	6,35	2,40	7,94	6,00	2,00	12,00	0,60	0,35	1,20
CNMM 250924-HY	CNMM 866-HY	25,400	9,52	2,40	9,12	8,00	2,50	15,00	0,70	0,40	1,40
CNMM 190612-HZ	CNMM 643-HZ	19,050	6,35	1,20	7,94	10,00	2,40	12,00	0,65	0,50	0,80
CNMM 190616-HZ	CNMM 644-HZ	19,050	6,35	1,60	7,94	10,00	2,40	12,00	0,80	0,50	1,10
CNMM 190624-HZ	CNMM 646-HZ	19,050	6,35	2,40	7,94	10,00	3,20	12,00	1,00	0,60	1,60
CNMM 250924-HZ	CNMM 866-HZ	25,400	9,52	2,40	9,12	10,00	3,20	17,00	1,00	0,60	1,60

DN = RHOMBIC 55° NEGATIVE

RÔMBICA 55° NEGATIVA | RÓMBICA 55° NEGATIVA

			P								M				K			N	S									
			CVD					PVD			CVD				PVD			CVD	UNC	PVD								
			(2) Grade code	T6	L7	R2	L8	R3	L9	V5	G1	G4	U4	U5	V6	G1	X6	G4	Y3	L5	L6	L9	10	G1	X6	G4	Y3	
Inserts Pastilhas Plaquitas	(1) Geometry code	ISO Reference	PHG105	PH5115	PHG115	PH5125	PHG125	PH5740	PHG140	PH7910	PH7920	PHS215	PHS225	PHS240	PH7910	PHH910	PH7920	PHH920	PH5705	PH5320	PH5740	PH0910	PH7910	PHH910	PH7920	PHH920		
 DNMA Roughing	1120975	DNMA 110404																										
	1120312	DNMA 150404																										
	1120313	DNMA 150408																										
	1121178	DNMA 150412																										
	1121496	DNMA 150416																										
	1120314	DNMA 150604																										
	1120315	DNMA 150608																										
	1120316	DNMA 150612																										
	1120317	DNMA 150616																										
 DNMG-MF Finishing	1121497	DNMG 110404-MF																										
	1121499	DNMG 110408-MF																										
	1121502	DNMG 150404-MF																										
	1121504	DNMG 150408-MF																										
	1121507	DNMG 150412-MF																										
	1121515	DNMG 150604-MF																										
	1121516	DNMG 150608-MF																										
1121517	DNMG 150612-MF																											
 DNMG-SF Medium to Finishing	1123749	DNMG 110404-SF																										
	1123750	DNMG 110408-SF																										
	1123751	DNMG 150404-SF																										
	1123752	DNMG 150408-SF																										
	1123753	DNMG 150412-SF																										
	1123754	DNMG 150604-SF																										
	1123755	DNMG 150608-SF																										
1123756	DNMG 150612-SF																											
 DNMG-LC Medium to Finishing	1123662	DNMG 150404-LC																										
	1123663	DNMG 150408-LC																										
	1123664	DNMG 150412-LC																										
	1122020	DNMG 150604-LC																										
	1122007	DNMG 150608-LC																										
1123655	DNMG 150612-LC																											

⊕ First choice | 1ª Escolha | 1ª Opción

⊕ Stock available until sold out | Stock disponível até acabar o stock | Stock disponible hasta acabar el stock

Insert Order Code: (1) Geometry code + (2) Grade code

⊖ Stock Items | Itens de stock

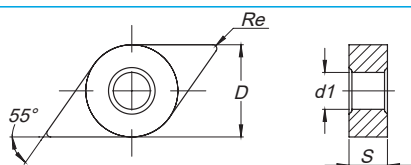

○ Available under request | Disponível sob consulta | Disponible bajo consulta



ISO Reference	ANSI Reference	Dimensions (mm) Dimensões (mm) Dimensiones (mm)				Cutting Conditions Condições de Corte Condiciones de Corte					
		D	S	Re	d1	ap (mm)	Min	Max	fn (mm/rev)	Min	Max
DNMA 110404	DNMA 331	9,525	4,76	0,40	3,81	2,00	0,20	3,50	0,15	0,10	0,30
DNMA 150404	DNMA 431	12,700	4,76	0,40	5,16	3,00	0,20	4,00	0,15	0,10	0,30
DNMA 150408	DNMA 432	12,700	4,76	0,80	5,16	3,00	0,20	6,00	0,35	0,15	0,60
DNMA 150412	DNMA 433	12,700	4,76	1,20	5,16	3,00	0,30	6,00	0,45	0,20	0,80
DNMA 150416	DNMA 434	12,700	4,76	1,60	5,16	3,00	0,30	6,00	0,55	0,20	1,00
DNMA 150604	DNMA 441	12,700	6,35	0,40	5,16	3,00	0,20	4,00	0,15	0,10	0,30
DNMA 150608	DNMA 442	12,700	6,35	0,80	5,16	3,00	0,20	6,00	0,35	0,15	0,60
DNMA 150612	DNMA 443	12,700	6,35	1,20	5,16	3,00	0,30	6,00	0,45	0,20	0,80
DNMA 150616	DNMA 444	12,700	6,35	1,60	5,16	3,00	0,30	6,00	0,55	0,20	1,00
DNMG 110404-MF	DNMG 331-MF	9,525	4,76	0,40	3,81	0,40	0,10	1,50	0,15	0,05	0,25
DNMG 110408-MF	DNMG 332-MF	9,525	4,76	0,80	3,81	0,40	0,10	1,50	0,20	0,10	0,40
DNMG 150404-MF	DNMG 431-MF	12,700	4,76	0,40	5,16	0,40	0,15	1,50	0,15	0,05	0,25
DNMG 150408-MF	DNMG 432-MF	12,700	4,76	0,80	5,16	0,40	0,20	1,50	0,20	0,10	0,40
DNMG 150412-MF	DNMG 433-MF	12,700	4,76	1,20	5,16	0,80	0,25	2,50	0,25	0,15	0,50
DNMG 150604-MF	DNMG 441-MF	12,700	6,35	0,40	5,16	0,40	0,10	1,50	0,15	0,05	0,25
DNMG 150608-MF	DNMG 442-MF	12,700	6,35	0,80	5,16	0,40	0,10	1,50	0,20	0,10	0,40
DNMG 150612-MF	DNMG 443-MF	12,700	6,35	1,20	5,16	0,80	0,20	2,50	0,25	0,15	0,50
DNMG 110404-SF	DNMG 331-SF	9,525	4,76	0,40	3,81	1,50	0,60	3,00	0,15	0,10	0,23
DNMG 110408-SF	DNMG 332-SF	9,525	4,76	0,80	3,81	1,50	0,60	3,00	0,25	0,12	0,38
DNMG 150404-SF	DNMG 431-SF	12,700	4,76	0,40	5,16	1,50	0,60	3,00	0,15	0,10	0,23
DNMG 150408-SF	DNMG 432-SF	12,700	4,76	0,80	5,16	1,50	0,60	3,00	0,25	0,12	0,38
DNMG 150412-SF	DNMG 433-SF	12,700	4,76	1,20	5,16	1,50	0,60	3,00	0,35	0,15	0,55
DNMG 150604-SF	DNMG 441-SF	12,700	6,35	0,40	5,16	1,50	0,60	3,00	0,15	0,10	0,23
DNMG 150608-SF	DNMG 442-SF	12,700	6,35	0,80	5,16	1,50	0,60	3,00	0,25	0,12	0,38
DNMG 150612-SF	DNMG 443-SF	12,700	6,35	1,20	5,16	1,50	0,60	3,00	0,35	0,15	0,55
DNMG 150404-LC	DNMG 431-LC	12,700	4,76	0,40	5,16	1,00	0,40	2,50	0,15	0,07	0,30
DNMG 150408-LC	DNMG 432-LC	12,700	4,76	0,80	5,16	1,50	0,40	2,50	0,20	0,10	0,40
DNMG 150412-LC	DNMG 433-LC	12,700	4,76	1,20	5,16	2,00	0,80	3,00	0,25	0,15	0,50
DNMG 150604-LC	DNMG 441-LC	12,700	6,35	0,40	5,16	1,50	0,40	3,00	0,15	0,07	0,30
DNMG 150608-LC	DNMG 442-LC	12,700	6,35	0,80	5,16	2,00	0,40	3,00	0,20	0,10	0,40
DNMG 150612-LC	DNMG 443-LC	12,700	6,35	1,20	5,16	2,50	0,80	3,50	0,25	0,15	0,50

DN = RHOMBIC 55° NEGATIVE

RÔMBICA 55° NEGATIVA | RÓMBICA 55° NEGATIVA

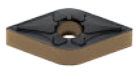
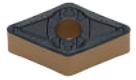
			P								M				K			N	S								
			CVD					PVD			CVD			PVD			CVD	UNC	PVD								
		(2) Grade code	T6	L7	R2	L8	R3	L9	V5	G1	G4	U4	U5	V6	G1	X6	G4	Y3	L5	L6	L9	10	G1	X6	G4	Y3	
Inserts Pastilhas Plaquetas	(1) Geometry code	ISO Reference	PHG105	PH5115	PHG115	PH5125	PHG125	PH5740	PHG140	PH7910	PH7920	PHS215	PHS225	PHS240	PH7910	PHH910	PH7920	PHH920	PH5705	PH5320	PH5740	PH0910	PH7910	PHH910	PH7920	PHH920	
 DNMG-MS Medium	1121503	DNMG 150404-MS																									
	1121505	DNMG 150408-MS																									
	1121509	DNMG 150412-MS																									
	1121513	DNMG 150416-MS																									
	1121927	DNMG 150604-MS																									
	1121928	DNMG 150608-MS																									
	1122030	DNMG 150612-MS																									
	 DNMG-GS Medium to Finishing	1124688	DNMG 110404-GS																								
1124689		DNMG 110408-GS																									
1124511		DNMG 150404-GS																									
1124512		DNMG 150408-GS																									
1124513		DNMG 150412-GS																									
1124682		DNMG 150604-GS																									
1124683		DNMG 150608-GS																									
1124684		DNMG 150612-GS																									
 DNMG-MR Medium	1121498	DNMG 110404-MR																									
	1121500	DNMG 110408-MR																									
	1121218	DNMG 150404-MR																									
	1121219	DNMG 150408-MR																									
	1121508	DNMG 150412-MR																									
	1121224	DNMG 150604-MR																									
	1121328	DNMG 150608-MR																									
	1121518	DNMG 150612-MR																									
 DNMG-PM Medium	1123924	DNMG 150404-PM																									
	1123916	DNMG 150408-PM																									
	1123925	DNMG 150412-PM																									
	1123926	DNMG 150416-PM																									
	1124065	DNMG 150604-PM																									
	1123777	DNMG 150608-PM																									
	1124066	DNMG 150612-PM																									
	1124082	DNMG 150616-PM																									

🔴 First choice | 1ª Escolha | 1ª Opción

🟩 Stock available until sold out | Stock disponível até acabar o stock | Stock disponible hasta acabar el stock

Insert Order Code: ⁽¹⁾ Geometry code + ⁽²⁾ Grade code

🟦 Stock Items | Itens de stock

🟨 Available under request | Disponível sob consulta | Disponible bajo consulta

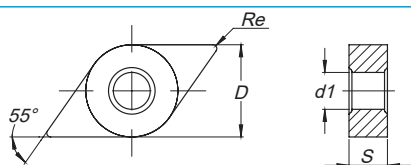

ISO Reference	ANSI Reference	Dimensions (mm) Dimensões (mm) Dimensiones (mm)				Cutting Conditions Condições de Corte Condiciones de Corte					
		D	S	Re	d1	ap (mm)	Min	Max	fn (mm/rev)	Min	Max
DNMG 150404-MS	DNMG 431-MS	12,700	4,76	0,40	5,16	1,50	0,20	3,60	0,15	0,10	0,20
DNMG 150408-MS	DNMG 432-MS	12,700	4,76	0,80	5,16	2,00	0,30	3,80	0,25	0,10	0,40
DNMG 150412-MS	DNMG 433-MS	12,700	4,76	1,20	5,16	2,50	0,40	4,00	0,30	0,15	0,60
DNMG 150416-MS	DNMG 434-MS	12,700	4,76	1,60	5,16	2,80	0,40	4,50	0,40	0,15	0,80
DNMG 150604-MS	DNMG 441-MS	12,700	6,35	0,40	5,16	1,50	0,20	3,60	0,15	0,10	0,20
DNMG 150608-MS	DNMG 442-MS	12,700	6,35	0,80	5,16	2,00	0,30	4,00	0,25	0,10	0,40
DNMG 150612-MS	DNMG 443-MS	12,700	6,35	1,20	5,16	2,80	0,40	4,50	0,30	0,15	0,60
DNMG 110404-GS	DNMG 331-GS	9,525	4,76	0,40	3,81	1,50	0,15	2,00	0,20	0,10	0,25
DNMG 110408-GS	DNMG 332-GS	9,525	4,76	0,80	3,81	2,00	0,20	2,50	0,25	0,10	0,30
DNMG 150404-GS	DNMG 431-GS	12,700	4,76	0,40	5,16	1,50	0,15	2,00	0,20	0,10	0,25
DNMG 150408-GS	DNMG 432-GS	12,700	4,76	0,80	5,16	2,00	0,20	2,50	0,25	0,10	0,30
DNMG 150412-GS	DNMG 433-GS	12,700	4,76	1,20	5,16	2,50	0,30	3,00	0,30	0,10	0,35
DNMG 150604-GS	DNMG 441-GS	12,700	6,35	0,40	5,16	1,50	0,15	2,00	0,20	0,10	0,25
DNMG 150608-GS	DNMG 442-GS	12,700	6,35	0,80	5,16	2,00	0,20	2,50	0,25	0,10	0,30
DNMG 150612-GS	DNMG 443-GS	12,700	6,35	1,20	5,16	2,50	0,30	3,00	0,30	0,10	0,35
DNMG 110404-MR	DNMG 331-MR	9,525	4,76	0,40	3,81	2,00	0,40	5,00	0,20	0,10	0,30
DNMG 110408-MR	DNMG 332-MR	9,525	4,76	0,80	3,81	2,00	0,50	5,00	0,30	0,15	0,50
DNMG 150404-MR	DNMG 431-MR	12,700	4,76	0,40	5,16	3,00	0,40	6,00	0,20	0,10	0,30
DNMG 150408-MR	DNMG 432-MR	12,700	4,76	0,80	5,16	3,00	0,50	6,00	0,30	0,15	0,50
DNMG 150412-MR	DNMG 433-MR	12,700	4,76	1,20	5,16	3,00	0,80	6,00	0,35	0,18	0,60
DNMG 150604-MR	DNMG 441-MR	12,700	6,35	0,40	5,16	3,00	0,40	6,00	0,20	0,10	0,30
DNMG 150608-MR	DNMG 442-MR	12,700	6,35	0,80	5,16	3,00	0,50	6,00	0,30	0,15	0,50
DNMG 150612-MR	DNMG 443-MR	12,700	6,35	1,20	5,16	3,00	0,80	6,00	0,35	0,18	0,60
DNMG 150616-MR	DNMG 444-MR	12,700	6,35	1,60	5,16	3,00	1,00	6,00	0,40	0,23	0,65
DNMG 150404-PM	DNMG 431-PM	12,700	4,76	0,40	5,16	3,00	0,40	6,00	0,20	0,10	0,30
DNMG 150408-PM	DNMG 432-PM	12,700	4,76	0,80	5,16	3,00	0,50	6,00	0,30	0,15	0,50
DNMG 150412-PM	DNMG 433-PM	12,700	4,76	1,20	5,16	3,00	0,80	6,00	0,35	0,18	0,60
DNMG 150416-PM	DNMG 434-PM	12,700	4,76	1,60	5,16	3,00	1,00	6,00	0,40	0,23	0,65
DNMG 150604-PM	DNMG 441-PM	12,700	6,35	0,40	5,16	2,50	0,50	5,00	0,25	0,15	0,40
DNMG 150608-PM	DNMG 442-PM	12,700	6,35	0,80	5,16	3,00	0,50	6,00	0,30	0,15	0,50
DNMG 150612-PM	DNMG 443-PM	12,700	6,35	1,20	5,16	3,50	0,50	7,00	0,35	0,20	0,60
DNMG 150616-PM	DNMG 444-PM	12,70	6,35	1,60	5,16	3,00	1,00	6,00	0,40	0,23	0,65

DN = RHOMBIC 55° NEGATIVE

RÔMBICA 55° NEGATIVA | RÓMBICA 55° NEGATIVA

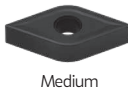
			P								M						K			N	S					
			CVD						PVD		CVD			PVD			CVD			UNC	PVD					
		(2) Grade code	T6	L7	R2	L8	R3	L9	V5	G1	G4	U4	U5	V6	G1	X6	G4	Y3	L5	L6	L9	10	G1	X6	G4	Y3
Inserts Pastilhas Plaquitas	(1) Geometry code	ISO Reference	PHG105	PH5115	PHG115	PH5125	PHG125	PH5740	PHG140	PH7910	PH7920	PHS215	PHS225	PHS240	PH7910	PHH910	PH7920	PHH920	PH5705	PH5320	PH5740	PH0910	PH7910	PHH910	PH7920	PHH920
 DNMG-ST Medium	1121346	DNMG 110404-ST																	⊗	⊗						
	1121347	DNMG 110408-ST																		⊗	⊗					
	1121255	DNMG 150404-ST																		⊗	⊗					
	1121256	DNMG 150408-ST																		⊗	⊗					
	1121512	DNMG 150412-ST																		⊗	⊗					
	1121514	DNMG 150416-ST																		⊗	⊗					
	1121257	DNMG 150604-ST																		⊗	⊗					
	1121258	DNMG 150608-ST																		⊗	⊗					
	1121521	DNMG 150612-ST																		⊗	⊗					
	1121523	DNMG 150616-ST																		⊗	⊗					

⊗ First choice | 1ª Escolha | 1ª Opción

⊗ Stock available until sold out | Stock disponível até acabar o stock | Stock disponible hasta acabar el stock

Insert Order Code: ⁽¹⁾Geometry code + ⁽²⁾Grade code

⊗ Stock Items | Itens de stock



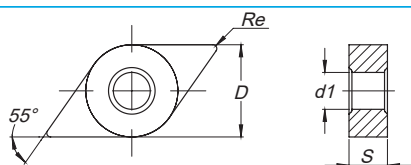



○ Available under request | Disponível sob consulta | Disponible bajo consulta

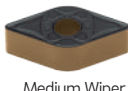
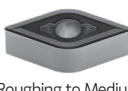

ISO Reference	ANSI Reference	Dimensions (mm) Dimensões (mm) Dimensiones (mm)				Cutting Conditions Condições de Corte Condiciones de Corte					
		D	S	Re	d1	ap (mm)	Min	Max	fn (mm/rev)	Min	Max
DNMG 110404-ST	DNMG 331-ST	9,525	4,76	0,40	3,81	2,00	0,20	3,50	0,20	0,15	0,30
DNMG 110408-ST	DNMG 332-ST	9,525	4,76	0,80	3,81	2,00	0,20	3,50	0,35	0,15	0,50
DNMG 150404-ST	DNMG 431-ST	12,700	4,76	0,40	5,16	2,50	0,20	5,00	0,20	0,15	0,30
DNMG 150408-ST	DNMG 432-ST	12,700	4,76	0,80	5,16	2,50	0,50	5,00	0,35	0,15	0,50
DNMG 150412-ST	DNMG 433-ST	12,700	4,76	1,20	5,16	3,00	0,50	6,00	0,50	0,25	0,70
DNMG 150416-ST	DNMG 434-ST	12,700	4,76	1,60	5,16	3,00	0,30	6,00	0,60	0,25	1,00
DNMG 150604-ST	DNMG 441-ST	12,700	6,35	0,40	5,16	2,50	0,20	5,00	0,20	0,15	0,30
DNMG 150608-ST	DNMG 442-ST	12,700	6,35	0,80	5,16	2,50	0,20	5,00	0,35	0,15	0,50
DNMG 150612-ST	DNMG 443-ST	12,700	6,35	1,20	5,16	3,00	0,30	6,00	0,50	0,15	0,70
DNMG 150616-ST	DNMG 444-ST	12,700	6,35	1,60	5,16	3,00	0,30	6,00	0,60	0,25	1,00

DN = RHOMBIC 55° NEGATIVE

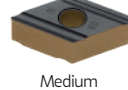
RÔMBICA 55° NEGATIVA | RÓMBICA 55° NEGATIVA

			P								M				K			N	S									
			CVD						PVD		CVD			PVD	CVD			UNC	PVD									
		(2) Grade code	T6	L7	R2	L8	R3	L9	V5	G1	G4	U4	U5	V6	G1	X6	G4	Y3	L5	L6	L9	10	G1	X6	G4	Y3		
Inserts Pastilhas Plaquitas	(1) Geometry code	ISO Reference	PHG105	PH5115	PHG115	PH5125	PHG125	PH5740	PHG140	PH7910	PH7920	PHS215	PHS225	PHS240	PH7910	PHH910	PH7920	PHH920	PH5705	PH5320	PH5740	PH0910	PH7910	PHH910	PH7920	PHH920		
 DNMG-MW Medium Wiper	1121374	DNMG 150408-MW	⊕	⊕	⊕	⊕	⊕	⊕											⊕	⊕	⊕							
	1121510	DNMG 150412-MW	⊕	⊕	⊕	⊕	⊕	⊕											⊕	⊕	⊕							
	1121375	DNMG 150608-MW			⊕		⊕	⊕												⊕	⊕	⊕						
	1121519	DNMG 150612-MW	⊕	⊕	⊕	⊕	⊕	⊕												⊕	⊕	⊕						
 DNMG-SS Roughing to Medium	1121501	DNMG 110408-SS										⊕	⊕	⊕	⊕								⊕			⊕		
	1121291	DNMG 150404-SS										⊕	⊕	⊕	⊕								⊕			⊕		
	1121292	DNMG 150408-SS										⊕	⊕	⊕	⊕								⊕			⊕		
	1121511	DNMG 150412-SS										⊕	⊕	⊕	⊕									⊕			⊕	
	1121284	DNMG 150604-SS										⊕	⊕	⊕	⊕									⊕			⊕	
	1121285	DNMG 150608-SS										⊕	⊕	⊕	⊕									⊕			⊕	
	1121520	DNMG 150612-SS										⊕	⊕	⊕	⊕									⊕			⊕	
	1121287	DNMG 150616-SS											⊕														⊕	
 DNMG-HR Roughing	1121253	DNMG 150408-HR	⊕	⊕	⊕	⊕	⊕												⊕	⊕	⊕							
	1121506	DNMG 150412-HR	⊕	⊕		⊕	⊕	⊕												⊕	⊕	⊕						
	1121254	DNMG 150608-HR			⊕		⊕	⊕												⊕	⊕	⊕						
	1121362	DNMG 150612-HR	⊕	⊕		⊕	⊕	⊕												⊕	⊕	⊕						
	1121340	DNMG 150616-HR	⊕	⊕	⊕	⊕	⊕	⊕												⊕	⊕	⊕						
 DNMM-RP Roughing	1124205	DNMM 150612-RP			⊕		⊕																					
 DNMX-02 Medium to Finishing	1120351	DNMX 150604-L02	⊕	⊕	⊕	⊕	⊕																					
	1120353	DNMX 150604-R02	⊕	⊕	⊕	⊕	⊕																					
	1120355	DNMX 150608-L02	⊕	⊕	⊕	⊕	⊕																					
	1120357	DNMX 150608-R02			⊕		⊕																					
 DNMX-03 Medium	1123983	DNMX 150604-L03	⊕	⊕		⊕	⊕																					
	1123815	DNMX 150604-R03	⊕	⊕		⊕	⊕																					
	1123796	DNMX 150608-L03			⊕		⊕																					
	1123795	DNMX 150608-R03			⊕		⊕																					
 DNMX-01 Roughing to Medium	1120348	DNMX 150408-L01			⊕																							
	1120349	DNMX 150408-R01			⊕																							
	1120350	DNMX 150604-L01	⊕	⊕	⊕																							
	1120352	DNMX 150604-R01	⊕	⊕																								
	1120354	DNMX 150608-L01	⊕	⊕																								
	1120356	DNMX 150608-R01			⊕																							

⊕ First choice | 1ª Escolha | 1ª Opción

⊕ Stock available until sold out | Stock disponível até acabar o stock | Stock disponible hasta acabar el stock

Insert Order Code: (1) Geometry code + (2) Grade code

⊕ Stock Items | Itens de stock

○ Available under request | Disponível sob consulta | Disponible bajo consulta

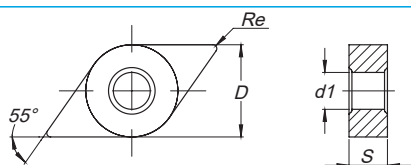

ISO Reference	ANSI Reference	Dimensions (mm) Dimensões (mm) Dimensiones (mm)				Cutting Conditions Condições de Corte Condiciones de Corte					
		D	S	Re	d1	ap (mm)	Min	Max	fn (mm/rev)	Min	Max
DNMG 150408-MW	DNMG 432-MW	12,700	4,76	0,80	5,16	2,50	0,30	4,00	0,35	0,15	0,60
DNMG 150412-MW	DNMG 433-MW	12,700	4,76	1,20	5,16	3,00	0,50	5,00	0,50	0,25	0,90
DNMG 150608-MW	DNMG 442-MW	12,700	6,35	0,80	5,16	3,00	0,30	4,50	0,35	0,15	0,60
DNMG 150612-MW	DNMG 443-MW	12,700	6,35	1,20	5,16	3,50	0,50	5,50	0,50	0,25	0,90
DNMG 110408-SS	DNMG 332-SS	9,525	4,76	0,80	3,81	2,00	0,50	4,40	0,25	0,12	0,45
DNMG 150404-SS	DNMG 431-SS	12,700	4,76	0,40	5,16	3,00	0,30	6,00	0,25	0,10	0,30
DNMG 150408-SS	DNMG 432-SS	12,700	4,76	0,80	5,16	3,00	0,50	6,40	0,25	0,12	0,45
DNMG 150412-SS	DNMG 433-SS	12,700	4,76	1,20	5,16	3,00	0,50	6,40	0,30	0,15	0,60
DNMG 150604-SS	DNMG 441-SS	12,700	6,35	0,40	5,16	3,00	0,30	6,00	0,25	0,10	0,30
DNMG 150608-SS	DNMG 442-SS	12,700	6,35	0,80	5,16	3,00	0,50	6,40	0,25	0,12	0,45
DNMG 150612-SS	DNMG 443-SS	12,700	6,35	1,20	5,16	3,00	0,50	6,40	0,30	0,15	0,60
DNMG 150616-SS	DNMG 444-SS	12,700	6,35	1,60	5,16	3,00	0,50	6,40	0,50	0,20	1,00
DNMG 150408-HR	DNMG 432-HR	12,700	4,76	0,80	5,16	4,00	0,80	6,00	0,35	0,20	0,55
DNMG 150412-HR	DNMG 433-HR	12,700	4,76	1,20	5,16	4,00	1,00	6,00	0,40	0,25	0,70
DNMG 150608-HR	DNMG 442-HR	12,700	6,35	0,80	5,16	4,00	0,80	6,00	0,35	0,20	0,55
DNMG 150612-HR	DNMG 443-HR	12,700	6,35	1,20	5,16	4,00	1,00	6,00	0,40	0,25	0,70
DNMG 150616-HR	DNMG 444-HR	12,700	6,35	1,60	5,16	4,00	1,50	6,00	0,50	0,30	0,80
DNMM 150612-RP	DNMM 443-RP	12,700	6,35	1,20	5,16	4,00	1,00	6,00	0,40	0,25	0,70
DNMX 150604-L02	DNMX 441-L02	12,700	6,35	0,40	5,16	2,50	0,70	5,00	0,20	0,14	0,25
DNMX 150604-R02	DNMX 441-R02	12,700	6,35	0,40	5,16	2,50	0,70	5,00	0,20	0,14	0,25
DNMX 150608-L02	DNMX 442-L02	12,700	6,35	0,80	5,16	3,00	0,80	5,00	0,35	0,14	0,50
DNMX 150608-R02	DNMX 442-R02	12,700	6,35	0,80	5,16	3,00	0,80	5,00	0,35	0,14	0,50
DNMX 150604-L03	DNMX 441-L03	12,700	6,35	0,40	5,16	2,70	0,80	5,50	0,20	0,15	0,25
DNMX 150604-R03	DNMX 441-R03	12,700	6,35	0,40	5,16	2,70	0,80	5,50	0,20	0,15	0,25
DNMX 150608-L03	DNMX 442-L03	12,700	6,35	0,80	5,16	3,20	1,00	6,00	0,35	0,16	0,50
DNMX 150608-R03	DNMX 442-R03	12,700	6,35	0,80	5,16	3,20	1,00	6,00	0,35	0,16	0,50
DNMX 150408-L01	DNMX 432-L01	12,700	4,76	0,80	5,16	2,50	1,00	5,00	0,35	0,20	0,50
DNMX 150408-R01	DNMX 432-R01	12,700	4,76	0,80	5,16	2,50	1,00	5,00	0,35	0,20	0,50
DNMX 150604-L01	DNMX 441-L01	12,700	6,35	0,40	5,16	3,00	1,50	6,00	0,25	0,15	0,30
DNMX 150604-R01	DNMX 441-R01	12,700	6,35	0,40	5,16	3,00	1,50	6,00	0,25	0,15	0,30
DNMX 150608-L01	DNMX 442-L01	12,700	6,35	0,80	5,16	3,50	2,00	6,50	0,35	0,20	0,50
DNMX 150608-R01	DNMX 442-R01	12,700	6,35	0,80	5,16	3,50	2,00	6,50	0,35	0,20	0,50

KN = PARALLELOGRAM 55° NEGATIVE

PARALELOGRAMA 55° NEGATIVA | PARALELOGRAMO 55° NEGATIVA

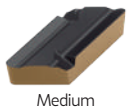
			P								M						K			N	S					
			CVD					PVD			CVD			PVD			CVD			UNC	PVD					
		(2) Grade code	T6	L7	R2	L8	R3	L9	V5	G1	G4	U4	U5	V6	G1	X6	G4	Y3	L5	L6	L9	10	G1	X6	G4	Y3
Inserts Pastilhas Plaquitas	(1) Geometry code	ISO Reference	PHG105	PH5115	PHG115	PH5125	PHG125	PH5740	PHG140	PH7910	PH7920	PHS215	PHS225	PHS240	PH7910	PHH910	PH7920	PHH920	PH5705	PH5320	PH5740	PH0910	PH7910	PHH910	PH7920	PHH920
 KNUX-01 Finishing	1120368	KNUX 160405-L01-PD			⊗		⊗																			
	1120371	KNUX 160405-R01-PD			⊗		⊗																			
 KNUX-02 Medium	1120374	KNUX 160410-L02			⊗		⊗																			
	1120376	KNUX 160410-R02			⊗		⊗																			

⊗ First choice | 1ª Escolha | 1ª Opción

⊕ Stock available until sold out | Stock disponível até acabar o stock | Stock disponible hasta acabar el stock

Insert Order Code: ⁽¹⁾Geometry code + ⁽²⁾Grade code

⊗ Stock Items | Itens de stock

○ Available under request | Disponível sob consulta | Disponible bajo consulta

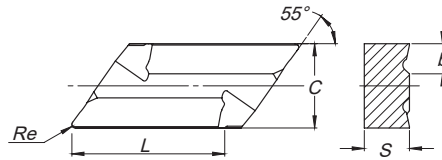

ISO Reference	ANSI Reference	Dimensions (mm) Dimensões (mm) Dimensiones (mm)					Cutting Conditions Condições de Corte Condiciones de Corte					
		L	C	Re	S	b	ap (mm)	Min	Max	fn (mm/rev)	Min	Max
KNUX 160405-L01	KNUX 160405-L01	16,50	9,525	0,5	4,76	2,5	3,00	1,00	6,00	0,30	0,20	0,35
KNUX 160405-R01	KNUX 160405-R01	16,50	9,525	0,5	4,76	2,5	3,00	1,00	6,00	0,30	0,20	0,35
KNUX 160410-L02	KNUX 160410-L02	16,50	9,525	1,0	4,76	3,2	4,00	1,50	6,00	0,50	0,40	0,70
KNUX 160410-R02	KNUX 160410-R02	16,50	9,525	1,0	4,76	3,2	4,00	1,50	6,00	0,50	0,40	0,70

RN = ROUND R° NEGATIVE

REDONDA R° NEGATIVA | REDONDA R° NEGATIVA

			P								M						K			N	S						
			CVD						PVD		CVD			PVD			CVD			UNC	PVD						
		(2) Grade code	T6	L7	R2	L8	R3	L9	V5	G1	G4	U4	U5	V6	G1	X6	G4	Y3	L5	L6	L9	10	G1	X6	G4	Y3	
Inserts Pastilhas Plaquitas	(1) Geometry code	ISO Reference	PHG105	PH5115	PHG115	PH5125	PHG125	PH5740	PHG140	PH7910	PH7920	PHS215	PHS225	PHS240	PH7910	PHH910	PH7920	PHH920	PH5705	PH5320	PH5740	PH0910	PH7910	PHH910	PH7920	PHH920	
 RNMG-ST Medium	1120439	RNMG 090300-ST					⊗																				
	1120440	RNMG 120400-ST					⊗																				
	1120441	RNMG 150600-ST				⊗	⊗																				
	1120442	RNMG 190600-ST				⊗	⊗																				
	1120443	RNMG 250900-ST		⊗		⊗	⊗														⊗						

⊗ First choice | 1ª Escolha | 1ª Opción

⊗ Stock available until sold out | Stock disponible até acabar o stock | Stock disponible hasta acabar el stock

Insert Order Code: ⁽¹⁾Geometry code + ⁽²⁾Grade code

⊗ Stock Items | Itens de stock

○ Available under request | Disponível sob consulta | Disponible bajo consulta

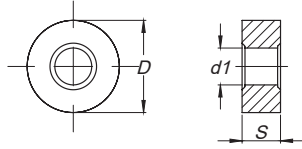

ISO Reference	ANSI Reference	Dimensions (mm) Dimensões (mm) Dimensiones (mm)				Cutting Conditions Condições de Corte Condiciones de Corte					
		D	S	Re	d1	ap (mm)	Min	Max	fn (mm/rev)	Min	Max
RNMG 090300-ST	RNMG 320-ST	9,525	3,18	-	3,18	2,30	0,90	4,50	0,30	0,10	0,90
RNMG 120400-ST	RNMG 430-ST	12,700	4,76	-	5,16	3,00	1,20	4,80	0,40	0,12	1,20
RNMG 150600-ST	RNMG 540-ST	15,875	6,35	-	6,35	3,80	1,50	7,50	0,50	0,15	1,50
RNMG 190600-ST	RNMG 640-ST	19,050	6,35	-	7,94	4,50	1,90	7,60	0,65	0,20	1,90
RNMG 250900-ST	RNMG 860-ST	25,400	9,52	-	9,12	6,30	2,50	10,00	0,80	0,25	2,50



TURNING

Insert selection

Overview

Negative inserts

Positive inserts

PCBN & PCD inserts

Heavy turning

External Toolholders

Internal Toolholders







Automatic Lathes

Spare Parts

Technical Data

SN = SQUARE 90° NEGATIVE

QUADRADA 90° NEGATIVA | ESQUADRA 90° NEGATIVA

			P								M				K			N	S								
			CVD					PVD			CVD				PVD		CVD	UNC	PVD								
		(2) Grade code	T6	L7	R2	L8	R3	L9	V5	G1	G4	U4	U5	V6	G1	X6	G4	Y3	L5	L6	L9	10	G1	X6	G4	Y3	
Inserts Pastilhas Plaquitas	(1) Geometry code	ISO Reference	PHG105	PH5115	PHG115	PH5125	PHG125	PH5740	PHG140	PH7910	PH7920	PHS215	PHS225	PHS240	PH7910	PHH910	PH7920	PHH920	PH5705	PH5320	PH5740	PH0910	PH7910	PHH910	PH7920	PHH920	
 SNMA Roughing	1121070	SNMA 090304																	⊗	⊗							
	1120474	SNMA 090308																		⊗	⊗						
	1120475	SNMA 120404																		⊗	⊗						
	1120476	SNMA 120408																		⊗	⊗						
	1120478	SNMA 120412																		⊗	⊗						
	1120479	SNMA 120416																		⊗	⊗						
	1120481	SNMA 150412																		⊗	⊗						
	1121525	SNMA 150612																		⊗	⊗						
	1120482	SNMA 190612																		⊗	⊗						
	1120483	SNMA 190616																		⊗	⊗						
	1120485	SNMA 190624																		⊗	⊗						
	1120486	SNMA 250724																		⊗	⊗						
 SNMG-MF Finishing	1121528	SNMG 120404-MF	⊗	⊗		⊗				⊗																	
	1121530	SNMG 120408-MF	⊗	⊗		⊗				⊗																	
	1121531	SNMG 120412-MF	⊗	⊗	⊗	⊗																					
 SNMG-SF Medium to Finishing	1123874	SNMG 120404-SF									⊗	⊗		⊗	○	⊗	○						⊗	○	⊗	○	
	1123875	SNMG 120408-SF									⊗	⊗		⊗	○	⊗	○						⊗	○	⊗	○	
	1123876	SNMG 120412-SF									⊗	⊗		⊗	○	⊗	○						⊗	○	⊗	○	
 SNMG-GS Medium to Finishing	1124556	SNMG 120408-GS													⊗		⊗						⊗		⊗		
	1124557	SNMG 120412-GS													⊗		⊗						⊗		⊗		
	1124558	SNMG 120416-GS													⊗		⊗						⊗		⊗		
 SNMG-MR Medium	1121529	SNMG 120404-MR			⊗		⊗	⊗																			
	1121179	SNMG 120408-MR			⊗		⊗	⊗																			
	1121311	SNMG 120412-MR	⊗	⊗		⊗	⊗	⊗																			
	1121357	SNMG 120416-MR				⊗	⊗	⊗																			
	1121533	SNMG 150608-MR	⊗	⊗		⊗	⊗																				
	1121536	SNMG 150612-MR			⊗		⊗	⊗																			
	1121543	SNMG 190612-MR	⊗	⊗		⊗	⊗	⊗																			
1121546	SNMG 190616-MR	⊗	⊗	⊗	⊗	⊗																					
 SNMG-PM Medium	1124083	SNMG 120404-PM	⊗		⊗		⊗																				
	1124084	SNMG 120408-PM	⊗		⊗		⊗																				
	1124085	SNMG 120412-PM	⊗		⊗		⊗																				

⊗ First choice | 1ª Escolha | 1ª Opción

⊗ Stock available until sold out | Stock disponível até acabar o stock | Stock disponible hasta acabar el stock

Insert Order Code: (1) Geometry code + (2) Grade code

⊗ Stock Items | Itens de stock



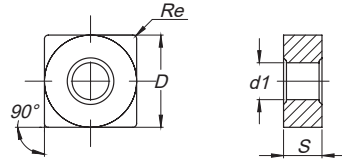

○ Available under request | Disponível sob consulta | Disponible bajo consulta



ISO Reference	ANSI Reference	Dimensions (mm) Dimensões (mm) Dimensiones (mm)				Cutting Conditions Condições de Corte Condiciones de Corte					
		D	S	Re	d1	ap (mm)	Min	Max	fn (mm/rev)	Min	Max
SNMA 090304	SNMA 321	9,525	3,18	0,40	3,81	2,50	0,20	4,50	0,20	0,15	0,30
SNMA 090308	SNMA 322	9,525	3,18	0,80	3,81	2,50	0,40	4,50	0,40	0,20	0,60
SNMA 120404	SNMA 431	12,700	4,76	0,40	5,16	4,00	0,20	8,00	0,20	0,15	0,30
SNMA 120408	SNMA 432	12,700	4,76	0,80	5,16	4,00	0,20	8,00	0,40	0,20	0,60
SNMA 120412	SNMA 433	12,700	4,76	1,20	5,16	4,00	0,30	8,00	0,45	0,20	0,80
SNMA 120416	SNMA 434	12,700	4,76	1,60	5,16	4,00	0,30	8,00	0,55	0,20	1,00
SNMA 150412	SNMA 533	15,875	4,76	1,20	6,35	5,00	0,30	9,00	0,45	0,20	0,80
SNMA 150612	SNMA 543	15,875	6,35	1,20	6,35	5,00	0,30	10,00	0,45	0,20	0,80
SNMA 190612	SNMA 643	19,050	6,35	1,20	7,94	6,00	0,30	12,00	0,45	0,20	0,80
SNMA 190616	SNMA 644	19,050	6,35	1,60	7,94	6,00	0,30	12,00	0,55	0,20	1,00
SNMA 190624	SNMA 646	19,050	6,35	2,40	7,94	6,00	0,30	12,00	0,60	0,20	1,20
SNMA 250724	SNMA 856	25,400	7,94	2,40	9,12	6,00	0,40	12,00	0,60	0,20	1,40
SNMG 120404-MF	SNMG 431-MF	12,700	4,76	0,40	5,16	0,40	0,15	1,50	0,10	0,05	0,25
SNMG 120408-MF	SNMG 432-MF	12,700	4,76	0,80	5,16	0,50	0,20	1,50	0,20	0,10	0,40
SNMG 120412-MF	SNMG 433-MF	12,700	4,76	1,20	5,16	0,80	0,25	2,50	0,30	0,20	0,60
SNMG 120404-SF	SNMG 431-SF	12,700	4,76	0,40	5,16	2,00	1,00	4,00	0,15	0,10	0,23
SNMG 120408-SF	SNMG 432-SF	12,700	4,76	0,80	5,16	2,00	1,00	4,00	0,20	0,12	0,38
SNMG 120412-SF	SNMG 433-SF	12,700	4,76	1,20	5,16	2,50	1,00	4,00	0,25	0,15	0,55
SNMG 120408-GS	SNMG 432-GS	12,700	4,76	0,80	5,16	2,00	0,20	3,00	0,30	0,15	0,40
SNMG 120412-GS	SNMG 433-GS	12,700	4,76	1,20	5,16	2,50	0,50	3,50	0,35	0,20	0,50
SNMG 120416-GS	SNMG 434-GS	12,700	4,76	1,60	5,16	3,00	0,50	4,00	0,40	0,20	0,50
SNMG 120404-MR	SNMG 431-MR	12,700	4,76	0,40	5,16	3,00	0,40	6,00	0,20	0,10	0,30
SNMG 120408-MR	SNMG 432-MR	12,700	4,76	0,80	5,16	3,00	0,50	6,00	0,30	0,15	0,50
SNMG 120412-MR	SNMG 433-MR	12,700	4,76	1,20	5,16	3,00	0,80	6,00	0,35	0,18	0,60
SNMG 120416-MR	SNMG 434-MR	12,700	4,76	1,60	5,16	3,00	1,00	6,00	0,40	0,23	0,65
SNMG 150608-MR	SNMG 542-MR	15,875	6,35	0,80	6,35	4,00	0,60	7,50	0,30	0,15	0,50
SNMG 150612-MR	SNMG 543-MR	15,875	6,35	1,20	6,35	4,00	0,80	7,50	0,35	0,18	0,60
SNMG 190612-MR	SNMG 643-MR	19,050	6,35	1,20	7,94	5,00	0,80	9,00	0,35	0,18	0,60
SNMG 190616-MR	SNMG 644-MR	19,050	6,35	1,60	7,94	5,00	1,00	9,00	0,40	0,23	0,65
SNMG 120404-PM	SNMG 431-PM	12,70	4,76	0,40	5,16	3,00	0,40	6,00	0,20	0,10	0,30
SNMG 120408-PM	SNMG 432-PM	12,70	4,76	0,80	5,16	3,00	0,50	6,00	0,30	0,15	0,50
SNMG 120412-PM	SNMG 433-PM	12,70	4,76	1,20	5,16	3,00	0,80	6,00	0,35	0,18	0,60

SN = SQUARE 90° NEGATIVE

QUADRADA 90° NEGATIVA | ESQUADRA 90° NEGATIVA

			P								M				K			N	S							
			CVD					PVD			CVD				PVD			CVD	UNC	PVD						
		(2) Grade code	T6	L7	R2	L8	R3	L9	V5	G1	G4	U4	U5	V6	G1	X6	G4	Y3	L5	L6	L9	10	G1	X6	G4	Y3
Inserts Pastilhas Plaquitas	(1) Geometry code	ISO Reference	PHG105	PH5115	PHG115	PH5125	PHG125	PH5740	PHG140	PH7910	PH7920	PHS215	PHS225	PHS240	PH7910	PHH910	PH7920	PHH920	PH5705	PH5320	PH5740	PH0910	PH7910	PHH910	PH7920	PHH920
 SNMG-ST Medium	1121338	SNMG 090308-ST																	⊗	⊗						
	1121241	SNMG 120404-ST																		⊗	⊗					
	1121181	SNMG 120408-ST																		⊗	⊗					
	1121310	SNMG 120412-ST																		⊗	⊗					
	1121242	SNMG 120416-ST																		⊗	⊗					
	1121544	SNMG 190612-ST																		⊗	⊗					
 SNMG-SS Roughing to Medium	1121548	SNMG 190616-ST																	⊗	⊗						
	1121526	SNMG 090304-SS													⊗		⊗						⊗		⊗	
	1121527	SNMG 090308-SS													⊗		⊗						⊗		⊗	
	1121365	SNMG 120404-SS											⊗		⊗		⊗						⊗		⊗	
	1121315	SNMG 120408-SS											⊗		⊗		⊗						⊗		⊗	
	1121366	SNMG 120412-SS											⊗		⊗		⊗						⊗		⊗	
	1121532	SNMG 120416-SS											⊗		⊗		⊗						⊗		⊗	
	1121534	SNMG 150608-SS												⊗		⊗		⊗								
	1121537	SNMG 150612-SS												⊗		⊗		⊗								
	1121547	SNMG 190616-SS												⊗		⊗		⊗								
 SNMG-HR Roughing	1121194	SNMG 120408-HR		⊗	⊗	⊗	⊗												⊗	⊗	⊗					
	1121195	SNMG 120412-HR		⊗	⊗		⊗													⊗	⊗	⊗				
	1121361	SNMG 120416-HR		⊗	⊗		⊗	⊗												⊗	⊗	⊗				
	1121535	SNMG 150612-HR					⊗			⊗												⊗				
	1121539	SNMG 150616-HR				⊗	⊗	⊗														⊗				
	1121542	SNMG 190612-HR		⊗	⊗		⊗	⊗														⊗				
	1121545	SNMG 190616-HR			⊗	⊗	⊗	⊗														⊗				
	1124184	SNMG 250724-HR					⊗																			
 SNMM-RP Roughing	1121638	SNMG 250924-HR			⊗	⊗															⊗					
	1124057	SNMM 150608-RP			⊗		⊗																			
	1124058	SNMM 150612-RP			⊗		⊗																			
	1124059	SNMM 150616-RP			⊗		⊗																			
	1124001	SNMM 190612-RP			⊗		⊗																			
	1124002	SNMM 190616-RP		⊗	⊗		⊗																			
	1124003	SNMM 190624-RP		⊗	⊗	⊗	⊗																			

⊗ First choice | 1ª Escolha | 1ª Opción

⊗ Stock available until sold out | Stock disponível até acabar o stock | Stock disponible hasta acabar el stock

Insert Order Code: ⁽¹⁾ Geometry code + ⁽²⁾ Grade code

⊗ Stock Items | Itens de stock

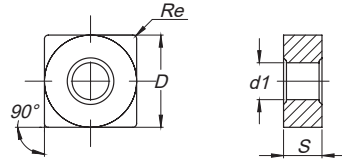

○ Available under request | Disponível sob consulta | Disponible bajo consulta



ISO Reference	ANSI Reference	Dimensions (mm) Dimensões (mm) Dimensiones (mm)				Cutting Conditions Condições de Corte Condiciones de Corte					
		D	S	Re	d1	ap (mm)	Min	Max	fn (mm/rev)	Min	Max
SNMG 090308-ST	SNMG 322-ST	9,525	3,18	0,80	3,81	2,50	0,20	4,50	0,35	0,15	0,50
SNMG 120404-ST	SNMG 431-ST	12,700	4,76	0,40	5,16	3,00	0,20	6,00	0,20	0,15	0,30
SNMG 120408-ST	SNMG 432-ST	12,700	4,76	0,80	5,16	3,00	0,20	6,00	0,35	0,15	0,50
SNMG 120412-ST	SNMG 433-ST	12,700	4,76	1,20	5,16	3,00	0,30	6,00	0,40	0,15	0,60
SNMG 120416-ST	SNMG 434-ST	12,700	4,76	1,60	5,16	3,00	0,30	6,00	0,45	0,20	0,70
SNMG 190612-ST	SNMG 643-ST	19,050	6,35	1,20	7,94	4,50	0,30	9,00	0,40	0,15	0,60
SNMG 190616-ST	SNMG 644-ST	19,050	6,35	1,60	7,94	4,50	0,30	9,00	0,45	0,20	0,70
SNMG 090304-SS	SNMG 321-SS	9,525	3,18	0,40	3,81	2,00	0,50	4,50	0,20	0,10	0,30
SNMG 090308-SS	SNMG 322-SS	9,525	3,18	0,80	3,81	2,00	0,50	4,50	0,25	0,12	0,45
SNMG 120404-SS	SNMG 431-SS	12,700	4,76	0,40	5,16	3,00	0,50	6,40	0,20	0,12	0,30
SNMG 120408-SS	SNMG 432-SS	12,700	4,76	0,80	5,16	3,00	0,50	6,40	0,25	0,12	0,45
SNMG 120412-SS	SNMG 433-SS	12,700	4,76	1,20	5,16	3,00	0,50	6,40	0,30	0,15	0,60
SNMG 120416-SS	SNMG 434-SS	12,700	4,76	1,60	5,16	3,00	0,50	6,40	0,45	0,15	0,80
SNMG 150608-SS	SNMG 542-SS	15,875	6,35	0,80	6,35	4,00	0,50	8,00	0,25	0,12	0,45
SNMG 150612-SS	SNMG 543-SS	15,875	6,35	1,20	6,35	4,00	0,50	8,00	0,30	0,15	0,60
SNMG 190616-SS	SNMG 644-SS	19,050	6,35	1,60	7,94	4,00	0,50	8,00	0,45	0,15	0,80
SNMG 120408-HR	SNMG 432-HR	12,700	4,76	0,80	5,16	4,00	0,80	7,00	0,35	0,20	0,55
SNMG 120412-HR	SNMG 433-HR	12,700	4,76	1,20	5,16	4,00	1,00	7,00	0,40	0,25	0,70
SNMG 120416-HR	SNMG 434-HR	12,700	4,76	1,60	5,16	4,00	1,50	7,00	0,50	0,32	0,80
SNMG 150612-HR	SNMG 543-HR	15,875	6,35	1,20	6,35	4,00	1,00	8,00	0,40	0,25	0,70
SNMG 150616-HR	SNMG 544-HR	15,875	6,35	1,60	6,35	4,00	1,50	8,00	0,50	0,32	0,80
SNMG 190612-HR	SNMG 643-HR	19,050	6,35	1,20	7,94	5,00	1,00	10,00	0,40	0,25	0,70
SNMG 190616-HR	SNMG 644-HR	19,050	6,35	1,60	7,94	5,00	1,50	10,00	0,50	0,32	0,80
SNMG 250724-HR	SNMG 856-HR	25,400	7,94	2,40	9,12	6,00	2,00	15,00	1,00	0,40	1,20
SNMG 250924-HR	SNMG 866-HR	25,400	9,52	2,40	9,12	6,00	2,00	15,00	1,00	0,40	1,20
SNMM 150608-RP	SNMG 542-RP	15,875	6,35	0,80	6,35	4,00	1,00	8,00	0,30	0,15	0,50
SNMM 150612-RP	SNMG 543-RP	15,875	6,35	1,20	6,35	4,00	1,00	8,00	0,40	0,25	0,70
SNMM 150616-RP	SNMG 544-RP	15,875	6,35	1,60	6,35	4,00	1,00	8,00	0,50	0,35	0,90
SNMM 190612-RP	SNMM 643-RP	19,050	6,35	1,20	7,94	5,50	2,00	12,00	0,60	0,30	0,85
SNMM 190616-RP	SNMM 644-RP	19,050	6,35	1,60	7,94	6,00	2,00	12,00	0,60	0,35	1,00
SNMM 190624-RP	SNMM 646-RP	19,050	6,35	2,40	7,94	6,00	2,00	12,00	0,80	0,50	1,50

SN = SQUARE 90° NEGATIVE

QUADRADA 90° NEGATIVA | ESQUADRA 90° NEGATIVA

			P								M				K			N	S								
			CVD					PVD		CVD			PVD			CVD			UNC	PVD							
		(2) Grade code	T6	L7	R2	L8	R3	L9	V5	G1	G4	U4	U5	V6	G1	X6	G4	Y3	L5	L6	L9	10	G1	X6	G4	Y3	
Inserts Pastilhas Plaquetas	(1) Geometry code	ISO Reference	PHG105	PH5115	PHG115	PH5125	PHG125	PH5740	PHG140	PH7910	PH7920	PHS215	PHS225	PHS240	PH7910	PHH910	PH7920	PHH920	PH5705	PH5320	PH5740	PH0910	PH7910	PHH910	PH7920	PHH920	
 SNMM-HY Heavy to Roughing	1121606	SNMM 190612-HY			⊗		⊗	⊗						⊗													
	1121250	SNMM 190616-HY			⊗		⊗	⊗						⊗													
	1121452	SNMM 190624-HY		⊗	⊗	⊗	⊗	⊗						⊗													
	1121160	SNMM 250724-HY		⊗	⊗		⊗		⊗					⊗													
	1121161	SNMM 250924-HY		⊗	⊗	⊗	⊗		⊗					⊗													
 SNMM-HZ Heavy to Roughing	1121605	SNMM 190612-HZ			⊗	⊗	⊗	⊗												⊗	⊗						
	1121249	SNMM 190616-HZ		⊗	⊗		⊗		⊗												⊗	⊗					
	1121440	SNMM 190624-HZ		⊗	⊗		⊗	⊗													⊗	⊗					
	1121158	SNMM 250724-HZ			⊗		⊗		⊗												⊗	⊗					
	1123786	SNMM 250732-HZ				⊗	⊗														⊗	⊗					
1121159	SNMM 250924-HZ		⊗	⊗	⊗	⊗		⊗												⊗	⊗						

⊗ First choice | 1ª Escolha | 1ª Opción
 ⊗ Stock Items | Itens de stock

⊗ Stock available until sold out | Stock disponível até acabar o stock | Stock disponible hasta acabar el stock
 ○ Available under request | Disponível sob consulta | Disponible bajo consulta



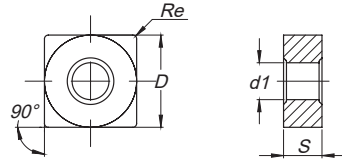



Insert Order Code: ⁽¹⁾ Geometry code + ⁽²⁾ Grade code



ISO Reference	ANSI Reference	Dimensions (mm) Dimensões (mm) Dimensiones (mm)				Cutting Conditions Condições de Corte Condiciones de Corte					
		D	S	Re	d1	ap (mm)	Min	Max	fn (mm/rev)	Min	Max
SNMM 190612-HY	SNMM 643-HY	19,050	6,35	1,20	7,94	6,00	2,00	12,00	0,60	0,35	0,90
SNMM 190616-HY	SNMM 644-HY	19,050	6,35	1,60	7,94	6,00	2,00	12,00	0,60	0,35	1,20
SNMM 190624-HY	SNMM 646-HY	19,050	6,35	2,40	7,94	6,00	2,00	12,00	1,00	0,60	1,60
SNMM 250724-HY	SNMM 856-HY	25,400	7,94	2,40	9,12	8,50	2,50	15,00	1,00	0,60	1,60
SNMM 250924-HY	SNMM 866-HY	25,400	9,52	2,40	9,12	8,50	3,00	15,00	1,00	0,60	1,60
SNMM 190612-HZ	SNMM 643-HZ	19,050	6,35	1,20	7,94	10,00	2,40	13,00	0,60	0,35	0,90
SNMM 190616-HZ	SNMM 644-HZ	19,050	6,35	1,60	7,94	10,00	2,40	13,00	0,60	0,35	1,20
SNMM 190624-HZ	SNMM 646-HZ	19,050	6,35	2,40	7,94	10,00	3,20	13,00	1,00	0,60	1,60
SNMM 250724-HZ	SNMM 856-HZ	25,400	7,94	2,40	9,12	10,00	3,20	17,00	1,00	0,60	1,60
SNMM 250732-HZ	SNMM 858-HZ	25,400	7,94	3,20	9,12	10,00	3,20	17,00	1,20	0,80	1,80
SNMM 250924-HZ	SNMM 866-HZ	25,400	9,52	2,40	9,12	10,00	3,20	17,00	1,00	0,60	1,60

TN = TRIANGULAR 60° NEGATIVE

TRIANGULAR 60° NEGATIVA | TRIANGULAR 60° NEGATIVA

			P								M				K			N	S								
			CVD					PVD			CVD				PVD		CVD	UNC	PVD								
		(2) Grade code	T6	L7	R2	L8	R3	L9	V5	G1	G4	U4	U5	V6	G1	X6	G4	Y3	L5	L6	L9	10	G1	X6	G4	Y3	
Inserts Pastilhas Plaquitas	(1) Geometry code	ISO Reference	PHG105	PH5115	PHG115	PH5125	PHG125	PH5740	PHG140	PH7910	PH7920	PHS215	PHS225	PHS240	PH7910	PHH910	PH7920	PHH920	PH5705	PH5320	PH5740	PH0910	PH7910	PHH910	PH7920	PHH920	
 TNMA Roughing	1120624	TNMA 110304																	⊗	⊗							
	1120625	TNMA 110308																		⊗	⊗						
	1120626	TNMA 160304																		⊗	⊗						
	1120627	TNMA 160308																		⊗	⊗						
	1120629	TNMA 160404																		⊗	⊗						
	1120630	TNMA 160408																		⊗	⊗						
	1120632	TNMA 160412																		⊗	⊗						
	1121921	TNMA 160416																		⊗	⊗						
	1120634	TNMA 220404																		⊗	⊗						
	1120635	TNMA 220408																		⊗	⊗						
	1120636	TNMA 220412																		⊗	⊗						
	1120637	TNMA 220416																		⊗	⊗						
	1121554	TNMA 270608																		⊗	⊗						
	1121555	TNMA 270612																		⊗	⊗						
	1120639	TNMA 270616																		⊗	⊗						
1120640	TNMA 330724																		⊗	⊗							
 TNMG-MF Finishing	1121556	TNMG 160404-MF	⊗		⊗					⊗																	
	1121558	TNMG 160408-MF	⊗	⊗	⊗					⊗																	
	1121560	TNMG 160412-MF		⊗	⊗					⊗																	
	1121369	TNMG 220408-MF		⊗	⊗																						
 TNMG-SF Medium to Finishing	1123757	TNMG 160404-SF										⊗	⊗		⊗	⊗	⊗						⊗	⊗	⊗	⊗	
	1123719	TNMG 160408-SF										⊗	⊗		⊗	⊗	⊗						⊗	⊗	⊗	⊗	
	1123758	TNMG 160412-SF										⊗	⊗		⊗	⊗	⊗						⊗	⊗	⊗	⊗	
	1124070	TNMG 220404-SF										⊗	⊗		⊗	⊗	⊗						⊗	⊗	⊗	⊗	
	1123759	TNMG 220408-SF										⊗	⊗		⊗	⊗	⊗						⊗	⊗	⊗	⊗	
	1124028	TNMG 220412-SF										⊗	⊗		⊗	⊗	⊗						⊗	⊗	⊗	⊗	
 TNMG-LC Medium to Finishing	1123638	TNMG 160404-LC	⊗		⊗																						
	1122025	TNMG 160408-LC		⊗	⊗					⊗																	
	1123656	TNMG 160412-LC			⊗	⊗				⊗																	
	1123660	TNMG 220408-LC		⊗	⊗	⊗				⊗																	
	1123657	TNMG 220412-LC		⊗	⊗	⊗				⊗																	
 TNMG-MS Medium	1121557	TNMG 160404-MS																⊗				⊗			⊗		
	1121559	TNMG 160408-MS																	⊗				⊗			⊗	
	1121561	TNMG 160412-MS																	⊗				⊗			⊗	
 TNMG-GS Medium to Finishing	1124508	TNMG 160404-GS																⊗		⊗				⊗		⊗	
	1124509	TNMG 160408-GS																	⊗		⊗				⊗		⊗
	1124510	TNMG 160412-GS																	⊗		⊗				⊗		⊗

⊗ First choice | 1ª Escolha | 1ª Opción
 ⊕ Stock Items | Itens de stock

⊕ Stock available until sold out | Stock disponível até acabar o stock | Stock disponible hasta acabar el stock
 ○ Available under request | Disponível sob consulta | Disponible bajo consulta

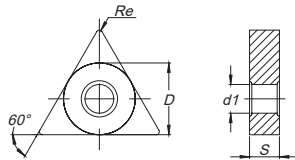

Insert Order Code: ⁽¹⁾ Geometry code + ⁽²⁾ Grade code



ISO Reference	ANSI Reference	Dimensions (mm) Dimensões (mm) Dimensiones (mm)				Cutting Conditions Condições de Corte Condiciones de Corte					
		D	S	Re	d1	ap (mm)	Min	Max	fn (mm/rev)	Min	Max
TNMA 110304	TNMA 221	6,350	3,18	0,40	2,26	2,00	0,15	4,00	0,20	0,10	0,30
TNMA 110308	TNMA 222	6,350	3,18	0,80	2,26	2,00	0,15	4,00	0,35	0,15	0,60
TNMA 160304	TNMA 321	9,525	3,18	0,40	3,81	2,50	0,20	5,00	0,20	0,10	0,30
TNMA 160308	TNMA 322	9,525	3,18	0,80	3,81	2,50	0,20	5,00	0,35	0,15	0,60
TNMA 160404	TNMA 331	9,525	4,76	0,40	3,81	2,50	0,20	5,00	0,20	0,10	0,30
TNMA 160408	TNMA 332	9,525	4,76	0,80	3,81	3,50	0,20	7,00	0,35	0,15	0,60
TNMA 160412	TNMA 333	9,525	4,76	1,20	3,81	3,50	0,30	7,00	0,45	0,20	0,80
TNMA 160416	TNMA 334	9,525	4,76	1,60	3,81	3,50	0,30	7,00	0,55	0,20	1,00
TNMA 220404	TNMA 431	12,700	4,76	0,40	5,16	4,00	0,20	10,00	0,20	0,10	0,30
TNMA 220408	TNMA 432	12,700	4,76	0,80	5,16	5,00	0,20	10,00	0,35	0,15	0,60
TNMA 220412	TNMA 433	12,700	4,76	1,20	5,16	5,00	0,30	10,00	0,45	0,20	0,80
TNMA 220416	TNMA 434	12,700	4,76	1,60	5,16	5,00	0,30	10,00	0,55	0,20	1,00
TNMA 270608	TNMA 542	15,875	6,35	0,80	6,35	5,00	0,30	12,00	0,35	0,15	0,60
TNMA 270612	TNMA 543	15,875	6,35	1,20	6,35	5,00	0,30	12,00	0,45	0,20	0,80
TNMA 270616	TNMA 544	15,875	6,35	1,60	6,35	5,00	0,30	12,00	0,55	0,20	1,00
TNMA 330724	TNMA 656	19,050	7,94	2,40	7,94	6,50	0,30	15,00	0,60	0,30	2,00
TNMG 160404-MF	TNMG 331-MF	9,525	4,76	0,40	3,81	0,40	0,10	1,50	0,15	0,05	0,25
TNMG 160408-MF	TNMG 332-MF	9,525	4,76	0,80	3,81	0,40	0,10	1,50	0,20	0,10	0,40
TNMG 160412-MF	TNMG 333-MF	9,525	4,76	1,20	3,81	1,00	0,20	2,50	0,30	0,15	0,60
TNMG 220408-MF	TNMG 432-MF	12,700	4,76	0,80	5,16	1,50	0,25	2,50	0,20	0,10	0,40
TNMG 160404-SF	TNMG 331-SF	9,525	4,76	0,40	3,81	1,50	0,60	3,00	0,15	0,10	0,23
TNMG 160408-SF	TNMG 332-SF	9,525	4,76	0,80	3,81	1,50	0,60	3,00	0,25	0,12	0,38
TNMG 160412-SF	TNMG 333-SF	9,525	4,76	1,20	3,81	1,50	0,60	3,00	0,35	0,15	0,55
TNMG 220404-SF	TNMG 431-SF	12,700	4,76	0,40	5,16	1,50	0,60	3,00	0,20	0,10	0,35
TNMG 220408-SF	TNMG 432-SF	12,700	4,76	0,80	5,16	1,50	0,60	3,00	0,25	0,12	0,40
TNMG 220412-SF	TNMG 433-SF	12,700	4,76	1,20	5,16	1,50	0,60	3,00	0,35	0,15	0,55
TNMG 160404-LC	TNMG 331-LC	9,525	4,76	0,40	3,81	1,00	0,40	2,50	0,15	0,07	0,30
TNMG 160408-LC	TNMG 332-LC	9,525	4,76	0,80	3,81	1,50	0,40	2,50	0,20	0,10	0,40
TNMG 160412-LC	TNMG 333-LC	9,525	4,76	1,20	3,81	2,00	0,80	3,00	0,25	0,15	0,50
TNMG 220408-LC	TNMG 432-LC	12,700	4,76	0,80	5,16	2,00	0,40	3,00	0,20	0,10	0,40
TNMG 220412-LC	TNMG 433-LC	12,700	4,76	1,20	5,16	2,50	0,80	3,50	0,25	0,15	0,50
TNMG 160404-MS	TNMG 331-MS	9,525	4,76	0,40	3,81	2,00	0,30	3,80	0,15	0,10	0,20
TNMG 160408-MS	TNMG 332-MS	9,525	4,76	0,80	3,81	2,00	0,30	3,80	0,25	0,10	0,40
TNMG 160412-MS	TNMG 333-MS	9,525	4,76	1,20	3,81	2,00	0,40	3,80	0,30	0,15	0,60
TNMG 160404-GS	TNMG 331-GS	9,525	4,76	0,40	3,81	2,00	0,15	3,00	0,20	0,10	0,30
TNMG 160408-GS	TNMG 332-GS	9,525	4,76	0,80	3,81	2,50	0,20	3,00	0,25	0,10	0,30
TNMG 160412-GS	TNMG 333-GS	9,525	4,76	1,20	3,81	3,00	0,30	3,50	0,30	0,15	0,35

TN = TRIANGULAR 60° NEGATIVE

TRIANGULAR 60° NEGATIVA | TRIANGULAR 60° NEGATIVA

			P								M				K			N	S									
			CVD					PVD			CVD			PVD			CVD	UNC	PVD									
		(2) Grade code	T6	L7	R2	L8	R3	L9	V5	G1	G4	U4	U5	V6	G1	X6	G4	Y3	L5	L6	L9	10	G1	X6	G4	Y3		
Inserts Pastilhas Plaquetas	(1) Geometry code	ISO Reference	PHG105	PH5115	PHG115	PH5125	PHG125	PH5740	PHG140	PH7910	PH7920	PHS215	PHS225	PHS240	PH7910	PHH910	PH7920	PHH920	PH5705	PH5320	PH5740	PH0910	PH7910	PHH910	PH7920	PHH920		
 <p>TNMG-MR Medium</p>	1122000	TNMG 160308-MR		⊕	⊕	⊕	⊕																					
	1121281	TNMG 160404-MR			⊕		⊕	⊕																				
	1121269	TNMG 160408-MR			⊕		⊕		⊕																			
	1121282	TNMG 160412-MR		⊕	⊕		⊕		⊕																			
	1121625	TNMG 220404-MR		⊕	⊕		⊕		⊕																			
	1121305	TNMG 220408-MR			⊕		⊕	⊕	⊕																			
	1121307	TNMG 220412-MR		⊕	⊕		⊕	⊕	⊕																			
	1121564	TNMG 220416-MR				⊕	⊕	⊕	⊕																			
 <p>TNMG-PM Medium</p>	1123991	TNMG 160404-PM	⊕		⊕		⊕																					
	1123917	TNMG 160408-PM	⊕		⊕		⊕																					
	1123992	TNMG 160412-PM	⊕		⊕		⊕																					
	1123993	TNMG 160416-PM			⊕		⊕																					
	1123922	TNMG 220404-PM			⊕		⊕																					
	1123923	TNMG 220408-PM			⊕		⊕																					
	1123994	TNMG 220412-PM			⊕		⊕																					
	1123995	TNMG 220416-PM			⊕		⊕																					
 <p>TNMG-ST Medium</p>	1121210	TNMG 110308-ST																										
	1121211	TNMG 160304-ST																										
	1121212	TNMG 160308-ST																										
	1121294	TNMG 160404-ST																		⊕	⊕							
	1121268	TNMG 160408-ST																		⊕	⊕							
	1121348	TNMG 160412-ST																		⊕	⊕							
	1121563	TNMG 160416-ST																		⊕	⊕							
	1121349	TNMG 220404-ST																		⊕	⊕							
	1121350	TNMG 220408-ST																		⊕	⊕							
	1121354	TNMG 220412-ST																		⊕	⊕							
1121351	TNMG 220416-ST																		⊕	⊕								

⊕ First choice | 1ª Escolha | 1ª Opción

⊕ Stock available until sold out | Stock disponível até acabar o stock | Stock disponible hasta acabar el stock

Insert Order Code: ⁽¹⁾ Geometry code + ⁽²⁾ Grade code

⊕ Stock items | Itens de stock

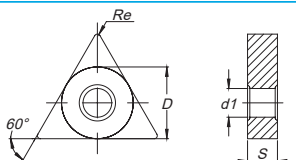

○ Available under request | Disponível sob consulta | Disponible bajo consulta



ISO Reference	ANSI Reference	Dimensions (mm) Dimensões (mm) Dimensiones (mm)				Cutting Conditions Condições de Corte Condiciones de Corte					
		D	S	Re	d1	ap (mm)	Min	Max	fn (mm/rev)	Min	Max
TNMG 160308-MR	TNMG 322-MR	9,525	3,18	0,80	3,81	2,80	0,30	5,00	0,30	0,15	0,50
TNMG 160404-MR	TNMG 331-MR	9,525	4,76	0,40	3,81	3,00	0,40	5,00	0,20	0,10	0,30
TNMG 160408-MR	TNMG 332-MR	9,525	4,76	0,80	3,81	3,00	0,50	5,00	0,30	0,15	0,50
TNMG 160412-MR	TNMG 333-MR	9,525	4,76	1,20	3,81	3,00	0,80	5,00	0,35	0,18	0,60
TNMG 220404-MR	TNMG 431-MR	12,700	4,76	0,40	5,16	4,00	0,40	6,60	0,20	0,10	0,30
TNMG 220408-MR	TNMG 432-MR	12,700	4,76	0,80	5,16	4,00	0,50	6,60	0,30	0,15	0,50
TNMG 220412-MR	TNMG 433-MR	12,700	4,76	1,20	5,16	4,00	0,80	6,60	0,35	0,18	0,60
TNMG 220416-MR	TNMG 434-MR	12,700	4,76	1,60	5,16	4,00	1,00	6,60	0,40	0,23	0,70
TNMG 160404-PM	TNMG 331-PM	9,525	4,76	0,40	3,81	3,00	0,40	5,00	0,20	0,10	0,30
TNMG 160408-PM	TNMG 332-PM	9,525	4,76	0,80	3,81	3,00	0,50	5,00	0,30	0,15	0,50
TNMG 160412-PM	TNMG 333-PM	9,525	4,76	1,20	3,81	3,00	0,80	5,00	0,35	0,18	0,60
TNMG 160416-PM	TNMG 334-PM	9,525	4,76	1,60	3,81	3,00	1,00	5,00	0,40	0,23	0,65
TNMG 220404-PM	TNMG 431-PM	12,700	4,76	0,40	5,16	4,00	0,40	6,60	0,20	0,10	0,30
TNMG 220408-PM	TNMG 432-PM	12,700	4,76	0,80	5,16	4,00	0,50	6,60	0,30	0,15	0,50
TNMG 220412-PM	TNMG 433-PM	12,700	4,76	1,20	5,16	4,00	0,80	6,60	0,35	0,18	0,60
TNMG 220416-PM	TNMG 434-PM	12,700	4,76	1,60	5,16	4,00	1,00	6,60	0,40	0,23	0,60
TNMG 110308-ST	TNMG 222-ST	6,350	3,18	0,80	2,26	2,00	0,15	4,50	0,35	0,15	0,50
TNMG 160304-ST	TNMG 321-ST	9,525	3,18	0,40	3,81	3,00	0,20	5,50	0,22	0,15	0,30
TNMG 160308-ST	TNMG 322-ST	9,525	3,18	0,80	3,81	3,00	0,20	5,50	0,35	0,15	0,50
TNMG 160404-ST	TNMG 331-ST	9,525	4,76	0,40	3,81	3,00	0,20	5,50	0,22	0,15	0,30
TNMG 160408-ST	TNMG 332-ST	9,525	4,76	0,80	3,81	3,00	0,20	5,50	0,35	0,15	0,50
TNMG 160412-ST	TNMG 333-ST	9,525	4,76	1,20	3,81	3,00	0,30	5,50	0,40	0,15	0,60
TNMG 160416-ST	TNMG 334-ST	9,525	4,76	1,60	3,81	3,00	0,30	5,50	0,40	0,15	0,60
TNMG 220404-ST	TNMG 431-ST	12,700	4,76	0,40	5,16	4,00	0,20	8,00	0,22	0,15	0,30
TNMG 220408-ST	TNMG 432-ST	12,700	4,76	0,80	5,16	4,00	0,20	8,00	0,35	0,15	0,50
TNMG 220412-ST	TNMG 433-ST	12,700	4,76	1,20	5,16	4,00	0,30	8,00	0,40	0,15	0,60
TNMG 220416-ST	TNMG 434-ST	12,700	4,76	1,60	5,16	4,00	0,30	8,00	0,45	0,20	0,70

TN = TRIANGULAR 60° NEGATIVE

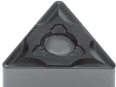
TRIANGULAR 60° NEGATIVA | TRIANGULAR 60° NEGATIVA

			P								M						K			N	S						
			CVD					PVD			CVD			PVD			CVD			UNC	PVD						
		(2) Grade code	T6	L7	R2	L8	R3	L9	V5	G1	G4	U4	U5	V6	G1	X6	G4	Y3	L5	L6	L9	10	G1	X6	G4	Y3	
Inserts Pastilhas Plaquitas	(1) Geometry code	ISO Reference	PHG105	PH5115	PHG115	PH5125	PHG125	PH5740	PHG140	PH7910	PH7920	PHS215	PHS225	PHS240	PH7910	PHH910	PH7920	PHH920	PH5705	PH5320	PH5740	PH0910	PH7910	PHH910	PH7920	PHH920	
 TNMG-MW Medium Wiper	1121376	TNMG 160408-MW			⊗		⊗	⊗												⊗	⊗						
	1121343	TNMG 160412-MW		⊗	⊗	⊗	⊗	⊗													⊗	⊗					
 TNMG-SS Roughing to Medium	1121289	TNMG 160404-SS										⊗	⊗	⊗	⊗		⊗						⊗		⊗		
	1121271	TNMG 160408-SS										⊗	⊗	⊗	⊗		⊗						⊗		⊗		
	1121290	TNMG 160412-SS										⊗	⊗	⊗	⊗		⊗						⊗		⊗		
	1121330	TNMG 220408-SS										⊗	⊗	⊗	⊗		⊗						⊗		⊗		
	1121368	TNMG 220412-SS											⊗				⊗						⊗		⊗		
 TNMG-HR Roughing	1121270	TNMG 160408-HR	⊗		⊗		⊗		⊗	○										⊗	⊗						
	1121283	TNMG 160412-HR		⊗	⊗		⊗		⊗	○											⊗	⊗					
	1121306	TNMG 220408-HR			⊗		⊗	⊗	⊗												⊗	⊗	⊗				
	1121308	TNMG 220412-HR		⊗	⊗		⊗		⊗												⊗	⊗	⊗				
	1121309	TNMG 220416-HR		⊗	⊗		⊗	⊗	⊗												⊗	⊗	⊗				
PCDN & PCD inserts	1121567	TNMG 270612-HR					⊗		⊗																		
	1121570	TNMG 270616-HR							⊗																		
	1121631	TNMG 330924-HR					⊗		⊗																		
	Heavy turning	1121004	TNMX 160404-L01			⊗		⊗																			
1120713		TNMX 160404-R01		⊗	⊗		⊗																				
1121005		TNMX 160408-L01		⊗	⊗		⊗																				
1121006		TNMX 160408-R01		⊗			⊗																				

⊗ First choice | 1ª Escolha | 1ª Opción

⊗ Stock available until sold out | Stock disponible até acabar o stock | Stock disponible hasta acabar el stock

Insert Order Code: ⁽¹⁾Geometry code + ⁽²⁾Grade code

⊗ Stock items | Itens de stock



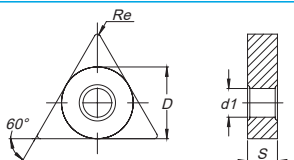







○ Available under request | Disponível sob consulta | Disponible bajo consulta

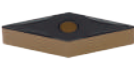

ISO Reference	ANSI Reference	Dimensions (mm) Dimensões (mm) Dimensiones (mm)				Cutting Conditions Condições de Corte Condiciones de Corte					
		D	S	Re	d1	ap (mm)	Min	Max	fn (mm/rev)	Min	Max
TNMG 160408-MW	TNMG 332-MW	9,525	4,76	0,80	3,81	2,00	0,50	4,50	0,35	0,15	0,60
TNMG 160412-MW	TNMG 333-MW	9,525	4,76	1,20	3,81	2,50	0,50	5,00	0,50	0,25	0,90
TNMG 160404-SS	TNMG 331-SS	9,525	4,76	0,40	3,81	2,00	0,50	4,00	0,20	0,10	0,30
TNMG 160408-SS	TNMG 332-SS	9,525	4,76	0,80	3,81	3,00	0,50	4,80	0,25	0,12	0,45
TNMG 160412-SS	TNMG 333-SS	9,525	4,76	1,20	3,81	3,00	0,50	4,80	0,30	0,15	0,60
TNMG 220408-SS	TNMG 432-SS	12,700	4,76	0,80	5,16	4,00	0,50	6,60	0,25	0,12	0,45
TNMG 220412-SS	TNMG 433-SS	12,700	4,76	1,20	5,16	4,00	0,50	6,60	0,30	0,15	0,60
TNMG 160408-HR	TNMG 332-HR	9,525	4,76	0,80	3,81	3,00	0,80	6,00	0,35	0,20	0,55
TNMG 160412-HR	TNMG 333-HR	9,525	4,76	1,20	3,81	3,00	1,00	6,00	0,40	0,25	0,70
TNMG 220408-HR	TNMG 432-HR	12,700	4,76	0,80	5,16	4,00	0,80	6,50	0,35	0,20	0,55
TNMG 220412-HR	TNMG 433-HR	12,700	4,76	1,20	5,16	4,00	1,00	7,00	0,40	0,25	0,70
TNMG 220416-HR	TNMG 434-HR	12,700	4,76	1,60	5,16	4,00	1,50	7,00	0,60	0,25	0,90
TNMG 270612-HR	TNMG 543-HR	15,875	6,35	1,20	6,35	6,00	2,00	10,00	0,40	0,25	0,70
TNMG 270616-HR	TNMG 544-HR	15,875	6,35	1,60	6,35	6,00	2,00	10,00	0,60	0,35	0,90
TNMG 330924-HR	TNMG 666-HR	19,050	9,52	2,40	7,94	7,00	2,00	12,00	0,80	0,40	1,20
TNMX 160404-L01	TNMX 331-L01	9,525	4,76	0,40	3,81	2,50	1,00	3,50	0,15	0,12	0,30
TNMX 160404-R01	TNMX 331-R01	9,525	4,76	0,40	3,81	2,50	1,00	3,50	0,15	0,12	0,30
TNMX 160408-L01	TNMX 332-L01	9,525	4,76	0,80	3,81	2,50	1,30	3,50	0,30	0,15	0,50
TNMX 160408-R01	TNMX 332-R01	9,525	4,76	0,80	3,81	2,50	1,30	3,50	0,30	0,15	0,50

VN = RHOMBIC 35° NEGATIVE

RÔMBICA 35° NEGATIVA | RÓMBICA 35° NEGATIVA

			P								M				K			N	S								
			CVD					PVD			CVD			PVD		CVD	UNC	PVD									
		(2) Grade code	T6	L7	R2	L8	R3	L9	V5	G1	G4	U4	U5	V6	G1	X6	G4	Y3	L5	L6	L9	10	G1	X6	G4	Y3	
Inserts Pastilhas Plaquetas	(1) Geometry code	ISO Reference	PHG105	PH5115	PHG115	PH5125	PHG125	PH5740	PHG140	PH7910	PH7920	PH5215	PH5225	PH5240	PH7910	PHH910	PH7920	PHH920	PH5705	PH5320	PH5740	PH0910	PH7910	PHH910	PH7920	PHH920	
 VNMA Roughing	1120819	VNMA 160404																	⊗	⊗							
	1121077	VNMA 160408																		⊗	⊗						
 VNMG-MF Finishing	1123635	VNMG 160404-MF			⊗		⊗			⊗																	
	1123636	VNMG 160408-MF	⊗		⊗		⊗			⊗																	
 VNMG-SF Medium to Finishing	1123760	VNMG 160404-SF										⊗	⊗		⊗	⊗	⊗						⊗	⊗	⊗	⊗	
	1123761	VNMG 160408-SF										⊗	⊗		⊗	⊗	⊗						⊗	⊗	⊗	⊗	
	1123762	VNMG 160412-SF										⊗	⊗		⊗	⊗	⊗						⊗	⊗	⊗	⊗	
 VNMG-LC Medium to Finishing	1123659	VNMG 160408-LC			⊗	⊗	⊗																				
 VNMG-MS Medium to Finishing	1121579	VNMG 160404-MS													⊗	⊗	⊗					⊗	⊗	⊗	⊗		
	1121580	VNMG 160408-MS													⊗	⊗	⊗					⊗	⊗	⊗	⊗		
 VNMG-GS Medium to Finishing	1124562	VNMG 160404-GS													⊗	⊗	⊗						⊗	⊗	⊗		
	1124563	VNMG 160408-GS													⊗	⊗	⊗						⊗	⊗	⊗		
	1124564	VNMG 160412-GS													⊗	⊗	⊗						⊗	⊗	⊗		
 VNMG-MR Medium	1121278	VNMG 160404-MR			⊗		⊗	⊗	⊗																		
	1121279	VNMG 160408-MR			⊗		⊗	⊗	⊗																		
	1121581	VNMG 220408-MR			⊗		⊗	⊗	⊗																		
 VNMG-PM Medium	1124086	VNMG 160404-PM	⊗		⊗		⊗																				
	1124087	VNMG 160408-PM	⊗		⊗		⊗																				
 VNMG-ST Medium	1121276	VNMG 160404-ST																	⊗	⊗							
	1121277	VNMG 160408-ST																		⊗	⊗						
 VNMG-SS Roughing to Medium	1121367	VNMG 160404-SS										⊗		⊗		⊗							⊗		⊗		
	1121295	VNMG 160408-SS										⊗		⊗		⊗							⊗		⊗		

⊗ First choice | 1ª Escolha | 1ª Opción
 ⊗ Stock Items | Itens de stock

⊗ Stock available until sold out | Stock disponível até acabar o stock | Stock disponible hasta acabar el stock
 ○ Available under request | Disponível sob consulta | Disponible bajo consulta



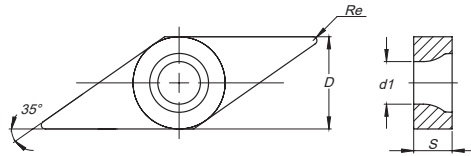

Insert Order Code: ⁽¹⁾ Geometry code + ⁽²⁾ Grade code

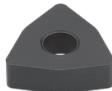
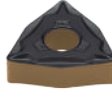

ISO Reference	ANSI Reference	Dimensions (mm) Dimensões (mm) Dimensiones (mm)				Cutting Conditions Condições de Corte Condiciones de Corte					
		D	S	Re	d1	ap (mm)	Min	Max	fn (mm/rev)	Min	Max
VNMA 160404	VNMA 331	9,525	4,76	0,40	3,81	0,20	0,10	3,30	0,15	0,08	0,25
VNMA 160408	VNMA 332	9,525	4,76	0,80	3,81	0,20	0,10	3,30	0,30	0,10	0,50
VNMG 160404-MF	VNMG 331-MF	9,525	4,76	0,40	3,81	0,50	0,15	1,50	0,15	0,05	0,25
VNMG 160408-MF	VNMG 332-MF	9,525	4,76	0,80	3,81	0,80	0,20	1,50	0,20	0,10	0,40
VNMG 160404-SF	VNMG 331-SF	9,525	4,76	0,40	3,81	1,50	0,60	3,00	0,15	0,10	0,23
VNMG 160408-SF	VNMG 332-SF	9,525	4,76	0,80	3,81	1,50	0,60	3,00	0,25	0,12	0,38
VNMG 160412-SF	VNMG 333-SF	9,525	4,76	1,20	3,81	1,50	0,60	3,00	0,35	0,15	0,55
VNMG 160408-LC	VNMG 332-LC	9,525	4,76	0,80	3,81	1,00	0,35	2,00	0,12	0,08	0,35
VNMG 160404-MS	VNMG 331-MS	9,525	4,76	0,40	3,81	2,00	0,20	4,00	0,15	0,10	0,20
VNMG 160408-MS	VNMG 332-MS	9,525	4,76	0,80	3,81	2,50	0,20	4,00	0,25	0,15	0,40
VNMG 160404-GS	VNMG 331-GS	9,525	4,76	0,40	3,81	1,50	0,15	2,00	0,20	0,08	0,25
VNMG 160408-GS	VNMG 332-GS	9,525	4,76	0,80	3,81	2,00	0,20	2,50	0,25	0,10	0,30
VNMG 160412-GS	VNMG 333-GS	9,525	4,76	1,20	3,81	2,50	0,30	3,00	0,30	0,12	0,35
VNMG 160404-MR	VNMG 331-MR	9,525	4,76	0,40	3,81	3,00	1,00	4,00	0,25	0,10	0,30
VNMG 160408-MR	VNMG 332-MR	9,525	4,76	0,80	3,81	3,00	1,00	4,00	0,30	0,15	0,50
VNMG 220408-MR	VNMG 432-MR	12,700	4,76	0,80	5,16	4,00	1,50	5,00	0,35	0,15	0,50
VNMG 160404-PM	VNMG 331-PM	9,525	4,76	0,40	3,81	3,00	1,00	4,00	0,25	0,10	0,30
VNMG 160408-PM	VNMG 332-PM	9,525	4,76	0,80	3,81	3,00	1,00	4,00	0,30	0,15	0,50
VNMG 160404-ST	VNMG 331-ST	9,525	4,76	0,40	3,81	2,00	0,20	3,50	0,30	0,15	0,40
VNMG 160408-ST	VNMG 332-ST	9,525	4,76	0,80	3,81	2,00	0,30	3,50	0,35	0,15	0,50
VNMG 160404-SS	VNMG 331-SS	9,525	4,76	0,40	3,81	1,50	0,50	4,00	0,20	0,10	0,30
VNMG 160408-SS	VNMG 332-SS	9,525	4,76	0,80	3,81	2,00	0,50	4,00	0,25	0,12	0,45

WN = TRIGON 80° NEGATIVE

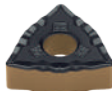
TRIGONAL 80° NEGATIVA | TRIGONA 80° NEGATIVA

			P								M						K			N	S					
			CVD					PVD			CVD			PVD			CVD			UNC	PVD					
		(2) Grade code	T6	L7	R2	L8	R3	L9	V5	G1	G4	U4	U5	V6	G1	X6	G4	Y3	L5	L6	L9	10	G1	X6	G4	Y3
Inserts Pastilhas Plaquetas	(1) Geometry code	ISO Reference	PHG105	PH5115	PHG115	PH5125	PHG125	PH5740	PHG140	PH7910	PH7920	PHS215	PHS225	PHS240	PH7910	PHH910	PH7920	PHH920	PH5705	PH5320	PH5740	PH0910	PH7910	PHH910	PH7920	PHH920
 WNMA Roughing	1122002	WNMA 060408																	⊗	⊗						
	1120834	WNMA 080404																	⊗	⊗						
	1120835	WNMA 080408																	⊗	⊗						
	1121076	WNMA 080412																	⊗	⊗						
	1121582	WNMA 080416																	⊗	⊗						
 WNMG-MF Finishing	1121205	WNMG 06T304-MF		⊗	⊗	⊗	⊗																			
	1121206	WNMG 06T308-MF		⊗	⊗	⊗	⊗																			
	1121586	WNMG 06T312-MF		⊗	⊗	⊗	⊗																			
	1121207	WNMG 060404-MF		⊗	⊗		⊗																			
	1121208	WNMG 060408-MF		⊗	⊗		⊗																			
	1121583	WNMG 060412-MF		⊗	⊗	⊗	⊗																			
	1121213	WNMG 080404-MF			⊗		⊗			⊗																
	1121214	WNMG 080408-MF	⊗	⊗	⊗		⊗			⊗																
1121589	WNMG 080412-MF		⊗	⊗	⊗	⊗																				
 WNMG-SF Medium to Finishing	1123763	WNMG 060404-SF										⊗	⊗		⊗	⊗	⊗						⊗	⊗	⊗	
	1123764	WNMG 060408-SF										⊗	⊗		⊗	⊗	⊗						⊗	⊗	⊗	
	1123765	WNMG 060412-SF										⊗	⊗		⊗	⊗	⊗						⊗	⊗	⊗	
	1123766	WNMG 080404-SF										⊗	⊗		⊗	⊗	⊗						⊗	⊗	⊗	
	1123721	WNMG 080408-SF										⊗	⊗		⊗	⊗	⊗						⊗	⊗	⊗	
	1123767	WNMG 080412-SF										⊗	⊗		⊗	⊗	⊗						⊗	⊗	⊗	
 WNMG-LC Medium to Finishing	1123658	WNMG 080408-LC	⊗		⊗	⊗																				
 WNMG-MS Medium	1121910	WNMG 060404-MS																⊗							⊗	
	1121911	WNMG 060408-MS																⊗							⊗	
	1124574	WNMG 080404-MS															⊗	⊗					⊗	⊗	⊗	
	1121588	WNMG 080408-MS															⊗	⊗					⊗	⊗	⊗	
	1121590	WNMG 080412-MS															⊗	⊗	⊗				⊗	⊗	⊗	
 WNMG-GS Medium to Finishing	1124690	WNMG 060404-GS																⊗						⊗	⊗	
	1124691	WNMG 060408-GS																⊗						⊗	⊗	
	1124559	WNMG 080404-GS															⊗	⊗					⊗	⊗	⊗	
	1124560	WNMG 080408-GS															⊗	⊗					⊗	⊗	⊗	
	1124561	WNMG 080412-GS															⊗	⊗	⊗				⊗	⊗	⊗	

⊗ First choice | 1ª Escolha | 1ª Opción

⊗ Stock available until sold out | Stock disponível até acabar o stock | Stock disponible hasta acabar el stock

Insert Order Code: (1) Geometry code + (2) Grade code

⊗ Stock Items | Itens de stock



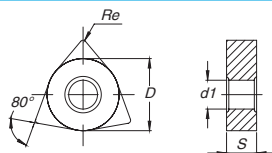



○ Available under request | Disponível sob consulta | Disponible bajo consulta



ISO Reference	ANSI Reference	Dimensions (mm) Dimensões (mm) Dimensiones (mm)				Cutting Conditions Condições de Corte Condiciones de Corte					
		D	S	Re	d1	ap (mm)	Min	Max	fn (mm/rev)	Min	Max
WNMA 060408	WNMA 332	9,525	4,76	0,80	3,81	2,50	0,20	4,00	0,35	0,15	0,60
WNMA 080404	WNMA 431	12,700	4,76	0,40	5,16	2,80	0,20	5,00	0,22	0,15	0,30
WNMA 080408	WNMA 432	12,700	4,76	0,80	5,16	3,00	0,20	5,00	0,35	0,15	0,60
WNMA 080412	WNMA 433	12,700	4,76	1,20	5,16	3,00	0,30	5,00	0,45	0,20	0,80
WNMA 080416	WNMA 434	12,700	4,76	1,60	5,16	3,00	0,30	5,00	0,55	0,20	1,00
WNMG 06T304-MF	WNMG 32.51-MF	9,525	3,97	0,40	3,81	0,40	0,10	1,50	0,15	0,05	0,30
WNMG 06T308-MF	WNMG 32.52-MF	9,525	3,97	0,80	3,81	0,40	0,10	1,50	0,20	0,10	0,40
WNMG 06T312-MF	WNMG 32.53-MF	9,525	3,97	1,20	3,81	0,40	0,15	1,50	0,30	0,15	0,60
WNMG 060404-MF	WNMG 331-MF	9,525	4,76	0,40	3,81	0,40	0,10	1,50	0,15	0,05	0,30
WNMG 060408-MF	WNMG 332-MF	9,525	4,76	0,80	3,81	0,40	0,10	1,50	0,20	0,10	0,40
WNMG 060412-MF	WNMG 333-MF	9,525	4,76	1,20	3,81	0,40	0,15	1,50	0,30	0,15	0,60
WNMG 080404-MF	WNMG 431-MF	12,700	4,76	0,40	5,16	0,60	0,10	2,00	0,15	0,05	0,30
WNMG 080408-MF	WNMG 432-MF	12,700	4,76	0,80	5,16	0,60	0,10	2,00	0,20	0,10	0,40
WNMG 080412-MF	WNMG 433-MF	12,700	4,76	1,20	5,16	0,60	0,15	2,00	0,30	0,15	0,60
WNMG 060404-SF	WNMG 331-SF	9,525	4,76	0,40	3,81	1,50	0,60	3,00	0,15	0,10	0,23
WNMG 060408-SF	WNMG 332-SF	9,525	4,76	0,80	3,81	1,50	0,60	3,00	0,25	0,12	0,38
WNMG 060412-SF	WNMG 333-SF	9,525	4,76	1,20	3,81	1,50	0,60	3,00	0,35	0,15	0,55
WNMG 080404-SF	WNMG 431-SF	12,700	4,76	0,40	5,16	1,50	0,60	3,00	0,15	0,10	0,23
WNMG 080408-SF	WNMG 432-SF	12,700	4,76	0,80	5,16	1,50	0,60	3,00	0,25	0,12	0,38
WNMG 080412-SF	WNMG 433-SF	12,700	4,76	1,20	5,16	1,50	0,60	3,00	0,35	0,15	0,55
WNMG 080408-LC	WNMG 432-LC	12,700	4,76	0,40	5,16	1,50	0,40	2,50	0,15	0,10	0,35
WNMG 060404-MS	WNMG 331-MS	9,525	4,76	0,40	3,81	1,20	0,30	2,20	0,15	0,10	0,20
WNMG 060408-MS	WNMG 332-MS	9,525	4,76	0,80	3,81	1,20	0,30	2,20	0,25	0,20	0,40
WNMG 080404-MS	WNMG 431-MS	12,700	4,76	0,40	5,16	2,50	0,70	4,00	0,15	0,10	0,30
WNMG 080408-MS	WNMG 432-MS	12,700	4,76	0,80	5,16	2,50	0,70	4,00	0,25	0,20	0,40
WNMG 080412-MS	WNMG 433-MS	12,700	4,76	1,20	5,16	2,50	1,00	4,00	0,30	0,25	0,55
WNMG 060404-GS	WNMG 331-GS	9,525	4,76	0,40	3,81	2,00	0,15	2,50	0,20	0,10	0,30
WNMG 060408-GS	WNMG 332-GS	9,525	4,76	0,80	3,81	2,50	0,25	3,00	0,25	0,10	0,35
WNMG 080404-GS	WNMG 431-GS	12,700	4,76	0,40	5,16	2,00	0,15	2,50	0,20	0,10	0,30
WNMG 080408-GS	WNMG 432-GS	12,700	4,76	0,80	5,16	2,50	0,25	3,00	0,25	0,10	0,35
WNMG 080412-GS	WNMG 433-GS	12,700	4,76	1,20	5,16	3,00	0,30	3,50	0,30	0,15	0,40

WN = TRIGON 80° NEGATIVE

TRIGONAL 80° NEGATIVA | TRIGONA 80° NEGATIVA

			P								M				K			N	S									
			CVD					PVD			CVD			PVD		CVD	UNC	PVD										
		(2) Grade code	T6	L7	R2	L8	R3	L9	V5	G1	G4	U4	U5	V6	G1	X6	G4	Y3	L5	L6	L9	10	G1	X6	G4	Y3		
Inserts Pastilhas Plaquetas	(1) Geometry code	ISO Reference	PHG105	PH5115	PHG115	PH5125	PHG125	PH5740	PHG140	PH7910	PH7920	PHS215	PHS225	PHS240	PH7910	PHH910	PH7920	PHH920	PH5705	PH5320	PH5740	PH0910	PH7910	PHH910	PH7920	PHH920		
 WNGM-MR Medium	1121262	WNGM 06T304-MR	⊗	⊗	⊗	⊗													⊗	⊗	⊗							
	1121167	WNGM 06T308-MR	⊗	⊗	⊗	⊗													⊗	⊗	⊗							
	1121587	WNGM 06T312-MR	⊗	⊗	⊗	⊗													⊗	⊗	⊗							
	1121240	WNGM 060404-MR	⊗	⊗		⊗														⊗	⊗	⊗						
	1121168	WNGM 060408-MR		⊗		⊗														⊗	⊗	⊗						
	1121584	WNGM 060412-MR	⊗	⊗	⊗	⊗														⊗	⊗	⊗						
	1121356	WNGM 080404-MR			⊗		⊗	⊗	⊗											⊗	⊗	⊗						
	1121327	WNGM 080408-MR			⊗		⊗		⊗											⊗	⊗	⊗						
	1121261	WNGM 080412-MR			⊗		⊗		⊗											⊗	⊗	⊗						
1121592	WNGM 080416-MR			⊗	⊗	⊗	⊗	⊗											⊗	⊗	⊗							
 WNGM-PM Medium	1124088	WNGM 060404-PM			⊗		⊗												⊗	⊗	⊗							
	1124089	WNGM 060408-PM			⊗		⊗												⊗	⊗	⊗							
	1123988	WNGM 080404-PM			⊗		⊗												⊗	⊗	⊗							
	1123918	WNGM 080408-PM			⊗		⊗												⊗	⊗	⊗							
	1123989	WNGM 080412-PM			⊗		⊗		⊗										⊗	⊗	⊗							
1123990	WNGM 080416-PM			⊗		⊗		⊗										⊗	⊗	⊗								
 WNGM-ST Medium	1121162	WNGM 080404-ST																	⊗	⊗	⊗							
	1121163	WNGM 080408-ST																	⊗	⊗	⊗							
	1121164	WNGM 080412-ST																	⊗	⊗	⊗							
	1121593	WNGM 080416-ST																	⊗	⊗	⊗							
 WNGM-MW Medium Wiper	1121370	WNGM 060408-MW	⊗	⊗		⊗		⊗											⊗	⊗	⊗							
	1121585	WNGM 060412-MW	⊗	⊗	⊗	⊗	⊗	⊗											⊗	⊗	⊗							
	1121372	WNGM 080408-MW			⊗		⊗	⊗	⊗										⊗	⊗	⊗							
	1121371	WNGM 080412-MW			⊗		⊗	⊗	⊗										⊗	⊗	⊗							
 WNGM-SS Roughing to Medium	1121321	WNGM 06T304-SS																⊗	⊗	⊗						⊗		
	1121324	WNGM 06T308-SS																	⊗	⊗	⊗					⊗		
	1121322	WNGM 060404-SS										⊗	⊗	⊗	⊗	⊗	⊗	⊗	⊗	⊗	⊗		⊗	⊗	⊗	⊗		
	1121325	WNGM 060408-SS										⊗	⊗	⊗	⊗	⊗	⊗	⊗	⊗	⊗	⊗		⊗	⊗	⊗	⊗		
	1121323	WNGM 080404-SS										⊗	⊗	⊗	⊗	⊗	⊗	⊗	⊗	⊗	⊗		⊗	⊗	⊗	⊗		
	1121326	WNGM 080408-SS										⊗	⊗	⊗	⊗	⊗	⊗	⊗	⊗	⊗	⊗		⊗	⊗	⊗	⊗		
	1121591	WNGM 080412-SS										⊗	⊗	⊗	⊗	⊗	⊗	⊗	⊗	⊗	⊗		⊗	⊗	⊗	⊗		
 WNGM-HR Roughing	1121127	WNGM 080408-HR	⊗		⊗		⊗		⊗										⊗	⊗	⊗							
	1121128	WNGM 080412-HR	⊗	⊗	⊗		⊗		⊗										⊗	⊗	⊗							

⊗ First choice | 1ª Escolha | 1ª Opción

⊗ Stock available until sold out | Stock disponível até acabar o stock | Stock disponible hasta acabar el stock

Insert Order Code: (1) Geometry code + (2) Grade code

⊗ Stock Items | Itens de stock



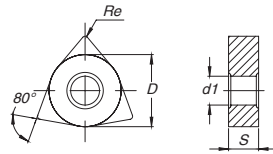

○ Available under request | Disponível sob consulta | Disponible bajo consulta

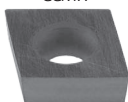

ISO Reference	ANSI Reference	Dimensions (mm) Dimensões (mm) Dimensiones (mm)				Cutting Conditions Condições de Corte Condiciones de Corte					
		D	S	Re	d1	ap (mm)	Min	Max	fn (mm/rev)	Min	Max
WNMG 06T304-MR	WNMG 32.51-MR	9,525	3,97	0,40	3,81	2,00	0,50	3,00	0,22	0,10	0,30
WNMG 06T308-MR	WNMG 32.52-MR	9,525	3,97	0,80	3,81	2,00	0,50	3,00	0,30	0,15	0,50
WNMG 06T312-MR	WNMG 32.53-MR	9,525	3,97	1,20	3,81	2,00	0,80	3,00	0,35	0,18	0,60
WNMG 060404-MR	WNMG 331-MR	9,525	4,76	0,40	3,81	2,00	0,50	3,00	0,22	0,10	0,30
WNMG 060408-MR	WNMG 332-MR	9,525	4,76	0,80	3,81	2,00	0,50	3,00	0,30	0,15	0,50
WNMG 060412-MR	WNMG 333-MR	9,525	4,76	1,20	3,81	2,00	0,80	3,00	0,35	0,18	0,60
WNMG 080404-MR	WNMG 431-MR	12,700	4,76	0,40	5,16	2,50	0,50	4,00	0,22	0,10	0,30
WNMG 080408-MR	WNMG 432-MR	12,700	4,76	0,80	5,16	2,50	0,50	4,00	0,30	0,15	0,50
WNMG 080412-MR	WNMG 433-MR	12,700	4,76	1,20	5,16	2,50	0,80	4,00	0,35	0,18	0,60
WNMG 080416-MR	WNMG 434-MR	12,700	4,76	1,60	5,16	3,00	1,00	4,00	0,40	0,23	0,65
WNMG 060404-PM	WNMG 331-PM	9,525	4,76	0,40	3,81	2,50	0,50	3,00	0,22	0,10	0,30
WNMG 060408-PM	WNMG 332-PM	9,525	7,76	0,80	3,81	2,50	0,50	3,00	0,30	0,15	0,50
WNMG 080404-PM	WNMG 431-PM	12,700	4,76	0,40	5,16	2,50	0,50	4,00	0,22	0,10	0,30
WNMG 080408-PM	WNMG 432-PM	12,700	4,76	0,80	5,16	2,50	0,50	4,00	0,30	0,15	0,50
WNMG 080412-PM	WNMG 433-PM	12,700	4,76	1,20	5,16	2,50	0,80	4,00	0,35	0,18	0,60
WNMG 080416-PM	WNMG 434-PM	12,700	4,76	1,60	5,16	3,00	1,00	4,50	0,35	0,20	0,65
WNMG 080404-ST	WNMG 431-ST	12,700	4,76	0,40	5,16	2,50	0,20	5,00	0,22	0,15	0,30
WNMG 080408-ST	WNMG 432-ST	12,700	4,76	0,80	5,16	2,50	0,20	5,00	0,35	0,15	0,50
WNMG 080412-ST	WNMG 433-ST	12,700	4,76	1,20	5,16	2,50	0,30	5,00	0,40	0,15	0,60
WNMG 080416-ST	WNMG 434-ST	12,700	4,76	1,60	5,16	2,50	0,30	5,00	0,45	0,20	0,70
WNMG 060408-MW	WNMG 332-MW	9,525	4,76	0,80	3,81	1,50	0,50	3,50	0,30	0,15	0,60
WNMG 060412-MW	WNMG 333-MW	9,525	4,76	1,20	3,81	1,50	0,80	3,50	0,50	0,20	0,90
WNMG 080408-MW	WNMG 432-MW	12,700	4,76	0,80	5,16	3,00	0,50	5,00	0,30	0,15	0,60
WNMG 080412-MW	WNMG 433-MW	12,700	4,76	1,20	5,16	3,50	0,80	6,00	0,50	0,20	0,90
WNMG 06T304-SS	WNMG 32.51-SS	9,525	3,97	0,40	3,81	2,00	0,50	3,00	0,20	0,12	0,30
WNMG 06T308-SS	WNMG 32.52-SS	9,525	3,97	0,80	3,81	2,00	0,50	3,00	0,25	0,12	0,45
WNMG 060404-SS	WNMG 331-SS	9,525	4,76	0,40	3,81	2,00	0,50	3,00	0,20	0,12	0,30
WNMG 060408-SS	WNMG 332-SS	9,525	4,76	0,80	3,81	2,00	0,50	3,00	0,25	0,12	0,45
WNMG 080404-SS	WNMG 431-SS	12,700	4,76	0,40	5,16	2,00	0,50	3,00	0,20	0,12	0,30
WNMG 080408-SS	WNMG 432-SS	12,700	4,76	0,80	5,16	2,50	0,50	4,00	0,25	0,12	0,45
WNMG 080412-SS	WNMG 433-SS	12,700	4,76	1,20	5,16	2,50	0,50	4,00	0,30	0,15	0,60
WNMG 080408-HR	WNMG 432-HR	12,700	4,76	0,80	5,16	4,00	0,80	5,00	0,35	0,20	0,55
WNMG 080412-HR	WNMG 433-HR	12,700	4,76	1,20	5,16	4,00	1,50	5,00	0,40	0,25	0,70

CC = RHOMBIC 80° POSITIVE

RÔMBICA 80° POSITIVA | RÓMBICA 80° POSITIVA

			P								M				K			N	S										
			CVD						PVD		CVD			PVD		CVD			UNC	PVD									
		(2) Grade code	T6	L7	R2	L8	R3	L9	V5	G1	G4	U4	U5	V6	G1	X6	G4	Y3	L5	L6	L9	10	G1	X6	G4	Y3			
Inserts Pastilhas Plaquitas	(1) Geometry code	ISO Reference	PHG105	PH5115	PHG115	PH5125	PHG125	PH5740	PHG140	PH7910	PH7920	PHS215	PHS225	PHS240	PH7910	PHH910	PH7920	PHH920	PH5705	PH5320	PH5740	PH0910	PH7910	PHH910	PH7920	PHH920			
	CCMW	1120206	CCMW 060204																										
		1120212	CCMW 09T304																										
	Finishing	1120214	CCMW 120404																										
	CCMT-FP	1121655	CCMT 060202-FP																										
		1121658	CCMT 060204-FP																										
	Finishing	1121690	CCMT 09T302-FP																										
		1121666	CCMT 09T304-FP																										
		1121652	CCMT 09T308-FP																										
	1121665	CCMT 120404-FP																											
	CCMT-BO	1121620	CCMT 060202-BO																										
		1121621	CCMT 060204-BO																										
	Finishing	1124090	CCMT 060208-BO																										
		1124091	CCMT 09T302-BO																										
		1121601	CCMT 09T304-BO																										
		1121622	CCMT 09T308-BO																										
		1121624	CCMT 120404-BO																										
		1121623	CCMT 120408-BO																										
	CCMT-FM	1121654	CCMT 060202-FM																										
		1121657	CCMT 060204-FM																										
	Finishing	1121689	CCMT 09T302-FM																										
		1121692	CCMT 09T304-FM																										
		1121651	CCMT 09T308-FM																										
	1121664	CCMT 120404-FM																											
	CCMT-FK	1121653	CCMT 060202-FK																										
		1121656	CCMT 060204-FK																										
	Finishing	1121688	CCMT 09T302-FK																										
		1121691	CCMT 09T304-FK																										
		1121663	CCMT 120404-FK																										

⊗ First choice | 1ª Escolha | 1ª Opción

⊕ Stock available until sold out | Stock disponível até acabar o stock | Stock disponible hasta acabar el stock

Insert Order Code: ⁽¹⁾ Geometry code + ⁽²⁾ Grade code

⊖ Stock Items | Itens de stock

○ Available under request | Disponível sob consulta | Disponible bajo consulta



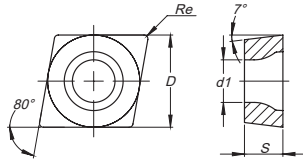

RELIEF ANGLE 7°



ISO Reference	ANSI Reference	Dimensions (mm) Dimensões (mm) Dimensiones (mm)				Cutting Conditions Condições de Corte Condiciones de Corte					
		D	S	Re	d1	ap (mm)	Min	Max	fn (mm/rev)	Min	Max
CCMW 060204	CCMW 21.51	6,350	2,38	0,40	2,80	1,50	0,05	3,00	0,20	0,08	0,26
CCMW 09T304	CCMW 32.51	9,525	3,97	0,40	4,40	2,30	0,05	4,50	0,20	0,08	0,26
CCMW 120404	CCMW 431	12,700	4,76	0,40	5,50	3,10	0,05	6,00	0,20	0,08	0,26
CCMT 060202-FP	CCMT 21.50.5-FP	6,350	2,38	0,20	2,80	0,30	0,06	1,70	0,06	0,03	0,11
CCMT 060204-FP	CCMT 21.51-FP	6,350	2,38	0,40	2,80	0,30	0,10	1,70	0,08	0,05	0,17
CCMT 09T302-FP	CCMT 32.50.5-FP	9,525	3,97	0,20	4,40	0,35	0,08	2,00	0,08	0,04	0,13
CCMT 09T304-FP	CCMT 32.51-FP	9,525	3,97	0,40	4,40	0,35	0,11	2,00	0,11	0,06	0,23
CCMT 09T308-FP	CCMT 32.52-FP	9,525	3,97	0,80	4,40	0,35	0,15	2,00	0,20	0,08	0,45
CCMT 120404-FP	CCMT 431-FP	12,700	4,76	0,40	5,50	0,42	0,14	2,40	0,14	0,07	0,27
CCMT 060202-BO	CCMT 21.50.5-BO	6,350	2,38	0,20	2,80	0,50	0,30	1,00	0,08	0,05	0,13
CCMT 060204-BO	CCMT 21.51-BO	6,350	2,38	0,40	2,80	0,50	0,30	1,00	0,13	0,08	0,20
CCMT 060208-BO	CCMT 21.52-BO	6,350	2,38	0,80	2,80	0,50	0,30	1,00	0,20	0,10	0,30
CCMT 09T302-BO	CCMT 32.50.5-BO	9,525	3,97	0,20	4,40	0,80	0,40	1,20	0,12	0,07	0,20
CCMT 09T304-BO	CCMT 32.51-BO	9,525	3,97	0,40	4,40	0,80	0,50	1,20	0,13	0,08	0,20
CCMT 09T308-BO	CCMT 32.52-BO	9,525	3,97	0,80	4,40	0,80	0,50	1,20	0,20	0,10	0,30
CCMT 120404-BO	CCMT 431-BO	12,700	4,76	0,40	5,50	1,00	0,50	1,50	0,13	0,08	0,20
CCMT 120408-BO	CCMT 432-BO	12,700	4,76	0,80	5,50	1,00	0,50	1,50	0,20	0,10	0,30
CCMT 060202-FM	CCMT 21.50.5-FM	6,350	2,38	0,20	2,80	0,30	0,06	1,70	0,06	0,03	0,11
CCMT 060204-FM	CCMT 21.51-FM	6,350	2,38	0,40	2,80	0,30	0,10	1,70	0,08	0,05	0,17
CCMT 09T302-FM	CCMT 32.50.5-FM	9,525	3,97	0,20	4,40	0,35	0,08	2,00	0,08	0,04	0,13
CCMT 09T304-FM	CCMT 32.51-FM	9,525	3,97	0,40	4,40	0,35	0,11	2,00	0,11	0,06	0,23
CCMT 09T308-FM	CCMT 32.52-FM	9,525	3,97	0,80	4,40	0,35	0,15	2,00	0,20	0,08	0,45
CCMT 120404-FM	CCMT 431-FM	12,700	4,76	0,40	5,50	0,42	0,14	2,40	0,14	0,07	0,27
CCMT 060202-FK	CCMT 21.50.5-FK	6,350	2,38	0,20	2,80	0,30	0,06	1,70	0,06	0,03	0,11
CCMT 060204-FK	CCMT 21.51-FK	6,350	2,38	0,40	2,80	0,30	0,10	1,70	0,08	0,05	0,17
CCMT 09T302-FK	CCMT 32.50.5-FK	9,525	3,97	0,20	4,40	0,35	0,08	2,00	0,08	0,04	0,13
CCMT 09T304-FK	CCMT 32.51-FK	9,525	3,97	0,40	4,40	0,35	0,11	2,00	0,11	0,06	0,23
CCMT 120404-FK	CCMT 431-FK	12,700	4,76	0,40	5,50	0,42	0,14	2,40	0,14	0,07	0,27

CC = RHOMBIC 80° POSITIVE

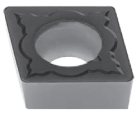
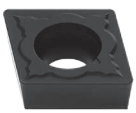
RÔMBICA 80° POSITIVA | RÓMBICA 80° POSITIVA

			P								M				K			N	S								
			CVD						PVD		CVD			PVD		CVD	UNC	PVD									
		(2) Grade code	T6	L7	R2	L8	R3	L9	V5	G1	G4	U4	U5	V6	G1	X6	G4	Y3	L5	L6	L9	10	G1	X6	G4	Y3	
Inserts Pastilhas Plaquetas	(1) Geometry code	ISO Reference	PHG105	PH5115	PHG115	PH5125	PHG125	PH5740	PHG140	PH7910	PH7920	PHS215	PHS225	PHS240	PH7910	PHH910	PH7920	PHH920	PH5705	PH5320	PH5740	PH0910	PH7910	PHH910	PH7920	PHH920	
 Finishing Wiper	CCMT-FW	1121398	CCMT 060204-FW																								
		1121743	CCMT 060208-FW																								
		1121399	CCMT 09T304-FW																								
		1121744	CCMT 09T308-FW																								
 Medium to Finishing	CCMT-LM	1123801	CCMT 060204-LM																								
		1123773	CCMT 09T304-LM																								
		1123804	CCMT 120404-LM																								
 Medium	CCMT-MP	1121697	CCMT 060204-MP																								
		1121661	CCMT 060208-MP																								
		1121700	CCMT 09T304-MP																								
		1121687	CCMT 09T308-MP																								
		1121719	CCMT 120404-MP																								
		1121722	CCMT 120408-MP																								
 Medium	CCMT-MM	1121696	CCMT 060204-MM																								
		1121660	CCMT 060208-MM																								
		1121699	CCMT 09T304-MM																								
		1121686	CCMT 09T308-MM																								
		1121718	CCMT 120404-MM																								
		1121721	CCMT 120408-MM																								
		1121723	CCMT 120412-MM																								
 Medium	CCMT-MK	1121695	CCMT 060204-MK																								
		1121659	CCMT 060208-MK																								
		1121698	CCMT 09T304-MK																								
		1121685	CCMT 09T308-MK																								
		1121717	CCMT 120404-MK																								
 Medium to Finishing Wiper	CCMT-MW	1121462	CCMT 060208-MW																								
		1121400	CCMT 09T304-MW																								
		1121411	CCMT 09T308-MW																								
		1121412	CCMT 120404-MW																								
	1121413	CCMT 120408-MW																									

⊗ First choice | 1ª Escolha | 1ª Opción

⊕ Stock available until sold out | Stock disponível até acabar o stock | Stock disponible hasta acabar el stock

Insert Order Code: ⁽¹⁾ Geometry code + ⁽²⁾ Grade code

⊖ Stock Items | Itens de stock

○ Available under request | Disponível sob consulta | Disponible bajo consulta

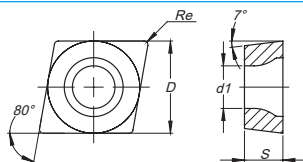

RELIEF ANGLE 7°



ISO Reference	ANSI Reference	Dimensions (mm) Dimensões (mm) Dimensiones (mm)				Cutting Conditions Condições de Corte Condiciones de Corte					
		D	S	Re	d1	ap (mm)	Min	Max	fn (mm/rev)	Min	Max
CCMT 060204-FW	CCMT 21.51-FW	6,350	2,38	0,40	2,80	0,80	0,30	2,00	0,12	0,05	0,30
CCMT 060208-FW	CCMT 21.52-FW	6,350	2,38	0,80	2,80	0,80	0,30	2,00	0,15	0,09	0,35
CCMT 09T304-FW	CCMT 32.51-FW	9,525	3,97	0,40	4,40	1,00	0,30	3,00	0,20	0,07	0,30
CCMT 09T308-FW	CCMT 32.52-FW	9,525	3,97	0,80	4,40	1,00	0,30	3,00	0,25	0,12	0,50
CCMT 060204-LM	CCMT 21.51-LM	6,350	2,38	0,40	2,80	0,50	0,20	2,00	0,10	0,08	0,20
CCMT 09T304-LM	CCMT 32.51-LM	9,525	3,97	0,40	4,40	0,50	0,25	2,50	0,15	0,10	0,30
CCMT 120404-LM	CCMT 431-LM	12,700	4,76	0,40	5,50	0,80	0,30	3,00	0,18	0,12	0,35
CCMT 060204-MP	CCMT 21.51-MP	6,350	2,38	0,40	2,80	0,64	0,20	2,40	0,11	0,06	0,17
CCMT 060208-MP	CCMT 21.52-MP	6,350	2,38	0,80	2,80	0,64	0,40	2,40	0,18	0,08	0,35
CCMT 09T304-MP	CCMT 32.51-MP	9,525	3,97	0,40	4,40	0,64	0,25	3,00	0,15	0,08	0,23
CCMT 09T308-MP	CCMT 32.52-MP	9,525	3,97	0,80	4,40	0,80	0,50	3,00	0,20	0,10	0,40
CCMT 120404-MP	CCMT 431-MP	12,700	4,76	0,40	5,50	0,96	0,30	3,60	0,18	0,09	0,27
CCMT 120408-MP	CCMT 432-MP	12,700	4,76	0,80	5,50	0,96	0,60	3,60	0,24	0,12	0,45
CCMT 120412-MP	CCMT 433-MP	12,700	4,76	1,20	5,50	0,96	0,72	3,60	0,35	0,14	0,60
CCMT 060204-MM	CCMT 21.51-MM	6,350	2,38	0,40	2,80	0,64	0,20	2,40	0,11	0,06	0,17
CCMT 060208-MM	CCMT 21.52-MM	6,350	2,38	0,80	2,80	0,64	0,40	2,40	0,18	0,08	0,35
CCMT 09T304-MM	CCMT 32.51-MM	9,525	3,97	0,40	4,40	0,64	0,25	3,00	0,15	0,08	0,23
CCMT 09T308-MM	CCMT 32.52-MM	9,525	3,97	0,80	4,40	0,80	0,50	3,00	0,20	0,10	0,40
CCMT 120404-MM	CCMT 431-MM	12,700	4,76	0,40	5,50	0,96	0,30	3,60	0,18	0,09	0,27
CCMT 120408-MM	CCMT 432-MM	12,700	4,76	0,80	5,50	0,96	0,60	3,60	0,24	0,12	0,45
CCMT 120412-MM	CCMT 433-MM	12,700	4,76	1,20	5,50	0,96	0,72	3,60	0,35	0,14	0,60
CCMT 060204-MK	CCMT 21.51-MK	6,350	2,38	0,40	2,80	0,64	0,20	2,40	0,11	0,06	0,17
CCMT 060208-MK	CCMT 21.52-MK	6,350	2,38	0,80	2,80	0,64	0,40	2,40	0,18	0,08	0,35
CCMT 09T304-MK	CCMT 32.51-MK	9,525	3,97	0,40	4,40	0,64	0,25	3,00	0,15	0,08	0,23
CCMT 09T308-MK	CCMT 32.52-MK	9,525	3,97	0,80	4,40	0,80	0,50	3,00	0,20	0,10	0,40
CCMT 120404-MK	CCMT 431-MK	12,700	4,76	0,40	5,50	0,96	0,30	3,60	0,18	0,09	0,27
CCMT 120408-MK	CCMT 432-MK	12,700	4,76	0,80	5,50	0,96	0,60	3,60	0,24	0,12	0,45
CCMT 060208-MW	CCMT 21.52-MW	6,350	2,38	0,80	2,80	1,20	0,50	2,50	0,20	0,10	0,40
CCMT 09T304-MW	CCMT 32.51-MW	9,525	3,97	0,40	4,40	1,50	0,50	4,00	0,25	0,12	0,40
CCMT 09T308-MW	CCMT 32.52-MW	9,525	3,97	0,80	4,40	1,50	0,70	4,00	0,30	0,15	0,50
CCMT 120404-MW	CCMT 431-MW	12,700	4,76	0,40	5,50	2,00	0,50	4,00	0,25	0,15	0,40
CCMT 120408-MW	CCMT 432-MW	12,700	4,76	0,80	5,50	2,00	0,70	4,00	0,30	0,15	0,50

CC = RHOMBIC 80° POSITIVE

RÔMBICA 80° POSITIVA | RÓMBICA 80° POSITIVA

			P								M				K			N	S							
			CVD					PVD			CVD			PVD		CVD			UNC	PVD						
		(2) Grade code	T6	L7	R2	L8	R3	L9	V5	G1	G4	U4	U5	V6	G1	X6	G4	Y3	L5	L6	L9	10	G1	X6	G4	Y3
Inserts Pastilhas Plaquitas	(1) Geometry code	ISO Reference	PHG105	PH5115	PHG115	PH5125	PHG125	PH5740	PHG140	PH7910	PH7920	PHS215	PHS225	PHS240	PH7910	PHH910	PH7920	PHH920	PH5705	PH5320	PH5740	PH0910	PH7910	PHH910	PH7920	PHH920
	CCGT-FS	1121725	CCGT 060201-FS							⊗	⊗				⊗	⊗	⊗	⊗					⊗	⊗	⊗	⊗
		1121726	CCGT 060202-FS							⊗	⊗				⊗	⊗	⊗	⊗					⊗	⊗	⊗	⊗
		1121727	CCGT 060204-FS							⊗	⊗				⊗	⊗	⊗	⊗					⊗	⊗	⊗	⊗
Finishing to Fine Finishing		1121455	CCGT 09T301-FS							⊗	⊗				⊗	⊗	⊗	⊗					⊗	⊗	⊗	⊗
		1121456	CCGT 09T302-FS							⊗	⊗				⊗	⊗	⊗	⊗					⊗	⊗	⊗	⊗
		1121457	CCGT 09T304-FS							⊗	⊗				⊗	⊗	⊗	⊗					⊗	⊗	⊗	⊗
	CCGT-LN	1121884	CCGT 060202-LN												⊗							⊗	⊗			
		1121885	CCGT 060204-LN												⊗							⊗	⊗			
	Medium to Finishing	1121886	CCGT 09T302-LN																			⊗				
Positive inserts		1121887	CCGT 09T304-LN												⊗							⊗	⊗			
		1121888	CCGT 09T308-LN																			⊗				
		1123679	CCGT 120402-LN																			⊗				
		1123681	CCGT 120404-LN																			⊗				
PCBN & PCD inserts		1123682	CCGT 120408-LN																			⊗				

⊗ First choice | 1ª Escolha | 1ª Opción

⊗ Stock available until sold out | Stock disponível até acabar o stock | Stock disponible hasta acabar el stock

Insert Order Code: ⁽¹⁾Geometry code + ⁽²⁾Grade code

⊗ Stock Items | Itens de stock

○ Available under request | Disponível sob consulta | Disponible bajo consulta



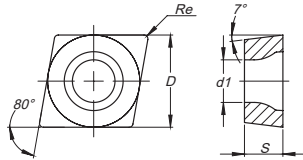



RELIEF ANGLE 7°

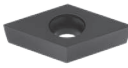
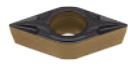

ISO Reference	ANSI Reference	Dimensions (mm) Dimensões (mm) Dimensiones (mm)				Cutting Conditions Condições de Corte Condiciones de Corte					
		D	S	Re	d1	ap (mm)	Min	Max	fn (mm/rev)	Min	Max
CCGT 060201-FS	CCGT 21.50.2-FS	6,350	2,38	0,10	2,80	0,30	0,10	1,00	0,03	0,01	0,06
CCGT 060202-FS	CCGT 21.50.5-FS	6,350	2,38	0,20	2,80	0,50	0,10	1,50	0,07	0,02	0,12
CCGT 060204-FS	CCGT 21.51-FS	6,350	2,38	0,40	2,80	0,80	0,15	1,50	0,20	0,08	0,25
CCGT 09T301-FS	CCGT 32.50.2-FS	9,525	3,97	0,10	4,40	0,50	0,10	1,50	0,03	0,01	0,06
CCGT 09T302-FS	CCGT 32.50.5-FS	9,525	3,97	0,20	4,40	1,00	0,10	2,00	0,07	0,02	0,12
CCGT 09T304-FS	CCGT 32.51-FS	9,525	3,97	0,40	4,40	1,25	0,15	2,50	0,15	0,08	0,25
CCGT 060202-LN	CCGT 21.50.5-LN	6,350	2,38	0,20	2,80	1,00	0,05	3,00	0,07	0,05	0,12
CCGT 060204-LN	CCGT 21.51-LN	6,350	2,38	0,40	2,80	1,55	0,10	3,00	0,15	0,10	0,20
CCGT 09T302-LN	CCGT 32.50.5-LN	9,525	3,97	0,20	4,40	1,53	0,05	3,00	0,07	0,05	0,12
CCGT 09T304-LN	CCGT 32.51-LN	9,525	3,97	0,40	4,40	2,55	0,10	5,00	0,16	0,10	0,22
CCGT 09T308-LN	CCGT 32.52-LN	9,525	3,97	0,80	4,40	2,55	0,10	5,00	0,22	0,15	0,45
CCGT 120402-LN	CCGT 430.5-LN	12,700	4,76	0,20	5,50	2,03	0,05	4,00	0,07	0,05	0,12
CCGT 120404-LN	CCGT 431-LN	12,700	4,76	0,40	5,50	2,55	0,10	5,00	0,17	0,10	0,26
CCGT 120408-LN	CCGT 432-LN	12,700	4,76	0,80	5,50	2,80	0,10	5,50	0,25	0,15	0,50

DC = RHOMBIC 55° POSITIVE

RÔMBICA 55° POSITIVA | RÓMBICA 55° POSITIVA

			P								M						K			N	S					
			CVD						PVD		CVD			PVD			CVD			UNC	PVD					
		(2) Grade code	T6	L7	R2	L8	R3	L9	V5	G1	G4	U4	U5	V6	G1	X6	G4	Y3	L5	L6	L9	10	G1	X6	G4	Y3
Inserts Pastilhas Plaquitas	(1) Geometry code	ISO Reference	PHG105	PH5115	PHG115	PH5125	PHG125	PH5740	PHG140	PH7910	PH7920	PHS215	PHS225	PHS240	PH7910	PHH910	PH7920	PHH920	PH5705	PH5320	PH5740	PH0910	PH7910	PHH910	PH7920	PHH920
 DCMW Finishing	1120302	DCMW 070202																								
	1120303	DCMW 070204																								
	1121422	DCMW 070208																								
	1120304	DCMW 11T302																								
	1120305	DCMW 11T304																								
	1120306	DCMW 11T308																								
 DCMT-FP Finishing	1121675	DCMT 070202-FP																								
	1121678	DCMT 070204-FP																								
	1121668	DCMT 11T302-FP																								
	1121711	DCMT 11T304-FP																								
 DCMT-FM Finishing	1121674	DCMT 070202-FM																								
	1121677	DCMT 070204-FM																								
	1121667	DCMT 11T302-FM																								
	1121710	DCMT 11T304-FM																								
	1121712	DCMT 11T308-FM																								
 DCMT-FK Finishing	1121673	DCMT 070202-FK																								
	1121676	DCMT 070204-FK																								
	1121714	DCMT 11T302-FK																								
	1121709	DCMT 11T304-FK																								
 DCMT-FW Finishing Wiper	1121749	DCMT 070204-FW																								
	1121750	DCMT 070208-FW																								
	1121745	DCMT 11T304-FW																								
	1121755	DCMT 11T308-FW																								
 DCMT-LM Medium to Finishing	1123802	DCMT 11T304-LM																								
	1123803	DCMT 11T308-LM																								
 DCMT-MP Medium	1121681	DCMT 070204-MP																								
	1121684	DCMT 070208-MP																								
	1121648	DCMT 11T304-MP																								
	1121706	DCMT 11T308-MP																								
	1121708	DCMT 11T312-MP																								

⊗ First choice | 1ª Escolha | 1ª Opción

⊕ Stock available until sold out | Stock disponível até acabar o stock | Stock disponible hasta acabar el stock

Insert Order Code: (1) Geometry code + (2) Grade code

⊖ Stock Items | Itens de stock

○ Available under request | Disponível sob consulta | Disponible bajo consulta



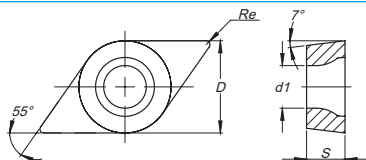

RELIEF ANGLE 7°



ISO Reference	ANSI Reference	Dimensions (mm) Dimensões (mm) Dimensiones (mm)				Cutting Conditions Condições de Corte Condiciones de Corte					
		D	S	Re	d1	ap (mm)	Min	Max	fn (mm/rev)	Min	Max
DCMW 070202	DCMW 21.50.5	6,350	2,38	0,20	2,80	1,60	0,05	3,20	0,10	0,04	0,13
DCMW 070204	DCMW 21.51	6,350	2,38	0,40	2,80	1,60	0,05	3,20	0,20	0,08	0,26
DCMW 070208	DCMW 21.52	6,350	2,38	0,80	2,80	1,60	0,05	3,20	0,40	0,16	0,53
DCMW 11T302	DCMW 32.50.5	9,525	3,97	0,20	4,40	2,40	0,05	4,80	0,10	0,04	0,13
DCMW 11T304	DCMW 32.51	9,525	3,97	0,40	4,40	2,40	0,05	4,80	0,20	0,08	0,26
DCMW 11T308	DCMW 32.52	9,525	3,97	0,80	4,40	2,40	0,05	4,80	0,40	0,16	0,53
DCMW 150404	DCMW 431	12,700	4,76	0,40	5,50	2,80	0,10	5,50	0,20	0,10	0,26
DCMT 070202-FP	DCMT 21.50.5-FP	6,350	2,38	0,20	2,80	0,26	0,06	1,50	0,06	0,03	0,11
DCMT 070204-FP	DCMT 21.51-FP	6,350	2,38	0,40	2,80	0,26	0,08	1,50	0,08	0,05	0,17
DCMT 11T302-FP	DCMT 32.50.5-FP	9,525	3,97	0,20	4,40	0,35	0,08	2,00	0,08	0,04	0,15
DCMT 11T304-FP	DCMT 32.51-FP	9,525	3,97	0,40	4,40	0,35	0,11	2,00	0,11	0,06	0,23
DCMT 11T308-FP	DCMT 32.52-FP	9,525	3,97	0,80	4,40	0,35	0,15	2,00	0,15	0,08	0,30
DCMT 070202-FM	DCMT 21.50.5-FM	6,350	2,38	0,20	2,80	0,26	0,06	1,50	0,06	0,03	0,11
DCMT 070204-FM	DCMT 21.51-FM	6,350	2,38	0,40	2,80	0,26	0,08	1,50	0,08	0,05	0,17
DCMT 11T302-FM	DCMT 32.50.5-FM	9,525	3,97	0,20	4,40	0,35	0,08	2,00	0,08	0,04	0,15
DCMT 11T304-FM	DCMT 32.51-FM	9,525	3,97	0,40	4,40	0,35	0,11	2,00	0,11	0,06	0,23
DCMT 11T308-FM	DCMT 32.52-FM	9,525	3,97	0,80	4,40	0,35	0,15	2,00	0,15	0,08	0,30
DCMT 070202-FK	DCMT 21.50.5-FK	6,350	2,38	0,20	2,80	0,26	0,06	1,50	0,06	0,03	0,11
DCMT 070204-FK	DCMT 21.51-FK	6,350	2,38	0,40	2,80	0,26	0,08	1,50	0,08	0,05	0,17
DCMT 11T302-FK	DCMT 32.50.5-FK	9,525	3,97	0,20	4,40	0,35	0,08	2,00	0,08	0,04	0,15
DCMT 11T304-FK	DCMT 32.51-FK	9,525	3,97	0,40	4,40	0,35	0,11	2,00	0,11	0,06	0,23
DCMT 070204-FW	DCMT 21.51-FW	6,350	2,38	0,40	2,80	0,70	0,30	2,00	0,12	0,05	0,25
DCMT 070208-FW	DCMT 21.52-FW	6,350	2,38	0,80	2,80	0,70	0,30	2,00	0,15	0,09	0,35
DCMT 11T304-FW	DCMT 32.51-FW	9,525	3,97	0,40	4,40	1,00	0,30	3,00	0,20	0,07	0,30
DCMT 11T308-FW	DCMT 32.52-FW	9,525	3,97	0,80	4,40	1,00	0,30	3,00	0,25	0,12	0,40
DCMT 11T304-LM	DCMT 32.51-LM	9,525	3,97	0,40	4,40	0,50	0,15	2,50	0,15	0,08	0,25
DCMT 11T308-LM	DCMT 32.52-LM	9,525	3,97	0,80	4,40	0,50	0,20	2,50	0,20	0,10	0,35
DCMT 070204-MP	DCMT 21.51-MP	6,350	2,38	0,40	2,80	0,60	0,19	2,25	0,11	0,06	0,17
DCMT 070208-MP	DCMT 21.52-MP	6,350	2,38	0,80	2,80	0,60	0,38	2,25	0,20	0,08	0,35
DCMT 11T304-MP	DCMT 32.51-MP	9,525	3,97	0,40	4,40	0,80	0,25	3,00	0,15	0,08	0,23
DCMT 11T308-MP	DCMT 32.52-MP	9,525	3,97	0,80	4,40	0,80	0,50	3,00	0,25	0,10	0,40
DCMT 11T312-MP	DCMT 32.53-MP	9,525	3,97	1,20	4,40	0,80	0,60	3,00	0,35	0,12	0,60

DC = RHOMBIC 55° POSITIVE

RÔMBICA 55° POSITIVA | RÓMBICA 55° POSITIVA

			P								M				K			N	S								
			CVD					PVD		CVD			PVD		CVD			UNC	PVD								
		(2) Grade code	T6	L7	R2	L8	R3	L9	V5	G1	G4	U4	U5	V6	G1	X6	G4	Y3	L5	L6	L9	10	G1	X6	G4	Y3	
Inserts Pastilhas Plaquetas	(1) Geometry code	ISO Reference	PHG105	PH5115	PHG115	PH5125	PHG125	PH5740	PHG140	PH7910	PH7920	PHS215	PHS225	PHS240	PH7910	PHH910	PH7920	PHH920	PH5705	PH5320	PH5740	PH0910	PH7910	PHH910	PH7920	PHH920	
 DCMT-MM Medium	1121680	DCMT 070204-MM										⊗			⊗	⊗	⊗						⊗	⊗	⊗	⊗	
	1121683	DCMT 070208-MM										⊗				⊗	⊗	⊗						⊗	⊗	⊗	
	1121647	DCMT 11T304-MM										⊗			⊗	⊗	⊗	⊗					⊗	⊗	⊗	⊗	
	1121705	DCMT 11T308-MM										⊗			⊗	⊗	⊗	⊗					⊗	⊗	⊗	⊗	
	1121707	DCMT 11T312-MM										⊗				⊗	⊗	⊗						⊗	⊗	⊗	
 DCMT-MK Medium	1121679	DCMT 070204-MK																	⊗	⊗							
	1121682	DCMT 070208-MK																	⊗	⊗							
	1121646	DCMT 11T304-MK																	⊗	⊗							
	1121704	DCMT 11T308-MK																	⊗	⊗							
	1121955	DCMT 11T312-MK																	⊗	⊗							
 DCMT-MW Medium to Finishing Wiper	1121414	DCMT 11T304-MW		⊗	⊗						⊗									⊗							
	1121756	DCMT 11T308-MW		⊗	⊗						⊗									⊗							
 DCGT-FS Finishing to Fine Finishing	1121747	DCGT 070201-FS								⊗	⊗				⊗	⊗	⊗	⊗					⊗	⊗	⊗	⊗	
	1121748	DCGT 070202-FS								⊗	⊗				⊗	⊗	⊗	⊗					⊗	⊗	⊗	⊗	
	1121872	DCGT 070204-FS								⊗	⊗				⊗	⊗	⊗	⊗					⊗	⊗	⊗	⊗	
	1121873	DCGT 11T301-FS								⊗	⊗				⊗	⊗	⊗	⊗					⊗	⊗	⊗	⊗	
	1121874	DCGT 11T302-FS								⊗	⊗				⊗	⊗	⊗	⊗					⊗	⊗	⊗	⊗	
	1121875	DCGT 11T304-FS								⊗	⊗				⊗	⊗	⊗	⊗					⊗	⊗	⊗	⊗	
	1124101	DCGT 11T308-FS									⊗							⊗							⊗		
 DCGT-LN Medium to Finishing	1121900	DCGT 070202-LN													⊗							⊗	⊗				
	1121901	DCGT 070204-LN													⊗								⊗	⊗			
	1111540	DCGT 11T302-LN													⊗								⊗	⊗			
	1111534	DCGT 11T304-LN													⊗								⊗	⊗			
	1121904	DCGT 11T308-LN													⊗								⊗	⊗			
	1124004	DCGT 11T312-LN																					⊗				

⊗ First choice | 1ª Escolha | 1ª Opción

⊗ Stock available until sold out | Stock disponível até acabar o stock | Stock disponible hasta acabar el stock

Insert Order Code: ⁽¹⁾Geometry code + ⁽²⁾Grade code

⊗ Stock Items | Itens de stock

○ Available under request | Disponível sob consulta | Disponible bajo consulta



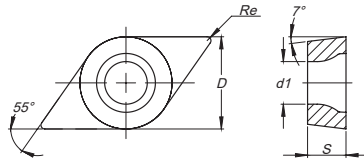





RELIEF ANGLE 7°



ISO Reference	ANSI Reference	Dimensions (mm) Dimensões (mm) Dimensiones (mm)				Cutting Conditions Condições de Corte Condiciones de Corte					
		D	S	Re	d1	ap (mm)	Min	Max	fn (mm/rev)	Min	Max
DCMT 070204-MM	DCMT 21.51-MM	6,350	2,38	0,40	2,80	0,60	0,19	2,25	0,11	0,06	0,17
DCMT 070208-MM	DCMT 21.52-MM	6,350	2,38	0,80	2,80	0,60	0,38	2,25	0,20	0,08	0,35
DCMT 11T304-MM	DCMT 32.51-MM	9,525	3,97	0,40	4,40	0,80	0,25	3,00	0,15	0,08	0,23
DCMT 11T308-MM	DCMT 32.52-MM	9,525	3,97	0,80	4,40	0,80	0,50	3,00	0,25	0,10	0,40
DCMT 11T312-MM	DCMT 32.53-MM	9,525	3,97	1,20	4,40	0,80	0,60	3,00	0,35	0,12	0,60
DCMT 070204-MK	DCMT 21.51-MK	6,350	2,38	0,40	2,80	0,60	0,19	2,25	0,11	0,06	0,17
DCMT 070208-MK	DCMT 21.52-MK	6,350	2,38	0,80	2,80	0,60	0,38	2,25	0,20	0,08	0,35
DCMT 11T304-MK	DCMT 32.51-MK	9,525	3,97	0,40	4,40	0,80	0,25	3,00	0,15	0,08	0,23
DCMT 11T308-MK	DCMT 32.52-MK	9,525	3,97	0,80	4,40	0,80	0,50	3,00	0,25	0,10	0,40
DCMT 11T312-MK	DCMT 32.53-MK	9,525	3,97	1,20	4,40	0,80	0,50	3,00	0,35	0,12	0,60
DCMT 11T304-MW	DCMT 32.51-MW	9,525	3,97	0,40	4,40	1,50	0,50	4,00	0,25	0,12	0,40
DCMT 11T308-MW	DCMT 32.52-MW	9,525	3,97	0,80	4,40	1,50	0,50	4,00	0,30	0,15	0,50
DCGT 070201-FS	DCGT 21.50.2-FS	6,350	2,38	0,10	2,80	0,30	0,10	1,00	0,03	0,01	0,06
DCGT 070202-FS	DCGT 21.50.5-FS	6,350	2,38	0,20	2,80	0,50	0,10	1,50	0,07	0,02	0,12
DCGT 070204-FS	DCGT 21.51-FS	6,350	2,38	0,40	2,80	0,80	0,15	1,50	0,15	0,08	0,25
DCGT 11T301-FS	DCGT 32.50.2-FS	9,525	3,97	0,10	4,40	0,50	0,10	1,50	0,03	0,01	0,06
DCGT 11T302-FS	DCGT 32.50.5-FS	9,525	3,97	0,20	4,40	1,00	0,10	2,00	0,07	0,02	0,12
DCGT 11T304-FS	DCGT 32.51-FS	9,525	3,97	0,40	4,40	1,50	0,15	3,00	0,15	0,08	0,25
DCGT 11T308-FS	DCGT 32.52-FS	9,525	3,97	0,80	4,40	2,00	0,20	3,50	0,18	0,10	0,30
DCGT 070202-LN	DCGT 21.50.5-LN	6,350	2,38	0,20	2,80	1,00	0,05	3,00	0,07	0,05	0,12
DCGT 070204-LN	DCGT 21.51-LN	6,350	2,38	0,40	2,80	2,05	0,10	4,00	0,15	0,10	0,20
DCGT 11T302-LN	DCGT 32.50.5-LN	9,525	3,97	0,20	4,40	2,03	0,05	4,00	0,07	0,05	0,12
DCGT 11T304-LN	DCGT 32.51-LN	9,525	3,97	0,40	4,40	2,55	0,10	5,00	0,16	0,10	0,22
DCGT 11T308-LN	DCGT 32.52-LN	9,525	3,97	0,80	4,40	2,55	0,10	5,00	0,22	0,15	0,50
DCGT 11T312-LN	DCGT 32.53-LN	9,525	3,97	1,20	4,40	2,70	0,15	5,00	0,35	0,15	0,70

RC = ROUND R° POSITIVE

REDONDA R° POSITIVA | REDONDA R° POSITIVA

			P								M				K			N	S							
			CVD					PVD			CVD			PVD		CVD	UNC	PVD								
		(2) Grade code	T6	L7	R2	L8	R3	L9	V5	G1	G4	U4	U5	V6	G1	X6	G4	Y3	L5	L6	L9	10	G1	X6	G4	Y3
Inserts Pastilhas Plaquetas	(1) Geometry code	ISO Reference	PHG105	PH5115	PHG115	PH5125	PHG125	PH5740	PHG140	PH7910	PH7920	PHS215	PHS225	PHS240	PH7910	PHH910	PH7920	PHH920	PH5705	PH5320	PH5740	PH0910	PH7910	PHH910	PH7920	PHH920
 RCMT-GS Medium to Finishing	NEW 1124495	RCMT 0803M0-GS																								
	1124496	RCMT 1003M0-GS																								
 RCMT-CP Medium	1120384	RCMT 0602M0-CP																								
 RCMT-ST Roughing to Medium	1120385	RCMT 0803M0-ST																								
	1120386	RCMT 1003M0-ST																								
	1120387	RCMT 10T3M0-ST																								
1120388 RCMT 1204M0-ST 1120389 RCMT 1606M0-ST 1120390 RCMT 2006M0-ST																										
 RCMT-RF Roughing to Medium	1123848	RCMT 2507M0-RF																								
 RCMT-RM Roughing to Medium	1123856	RCMT 2006M0-RM																								
 RCMX-ST Roughing to Medium	1121425	RCMX 1003M0-ST																								
	1121426	RCMX 1204M0-ST																								
	1121427	RCMX 1606M0-ST																								
	1121428	RCMX 2006M0-ST																								
	1121429	RCMX 2507M0-ST																								
1121430 RCMX 3209M0-ST																										
 RCMX-RM Roughing to Medium	1123678	RCMX 3209M0-RM																								
 RCMX-RR Roughing to Medium	1123667	RCMX 2507M0-RR																								
	1123666	RCMX 3209M0-RR																								

⊗ First choice | 1ª Escolha | 1ª Opción

⊕ Stock available until sold out | Stock disponível até acabar o stock | Stock disponible hasta acabar el stock

Insert Order Code: ⁽¹⁾ Geometry code + ⁽²⁾ Grade code

⊖ Stock Items | Itens de stock

○ Available under request | Disponível sob consulta | Disponible bajo consulta

RELIEF ANGLE 7°

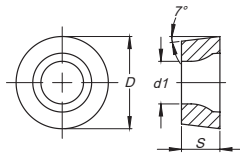

ISO Reference	ANSI Reference	Dimensions (mm) Dimensões (mm) Dimensiones (mm)				Cutting Conditions Condições de Corte Condiciones de Corte					
		D	S	Re	d1	ap (mm)	Min	Max	fn (mm/rev)	Min	Max
RCMT 0803M0-GS	RCMT 0803M0-GS	8,00	3,18	-	3,40	2,00	0,50	3,00	0,25	0,15	0,40
RCMT 1003M0-GS	RCMT 1003M0-GS	10,00	3,18	-	3,40	3,00	0,75	4,00	0,30	0,15	0,45
RCMT 0602M0-CP	RCMT 0602M0-CP	6,00	2,38	-	2,80	1,50	0,50	2,40	0,15	0,04	0,17
RCMT 0803M0-ST	RCMT 0803M0-ST	8,00	3,18	-	3,40	2,00	0,80	3,20	0,20	0,10	0,80
RCMT 1003M0-ST	RCMT 1003M0-ST	10,00	3,18	-	3,40	2,50	1,00	4,00	0,25	0,12	1,00
RCMT 10T3M0-ST	RCMT 10T3M0-ST	10,00	3,97	-	4,40	2,50	1,00	4,00	0,25	0,16	1,40
RCMT 1204M0-ST	RCMT 1204M0-ST	12,00	4,76	-	4,40	3,00	1,20	4,80	0,30	0,20	1,80
RCMT 1606M0-ST	RCMT 1606M0-ST	16,00	6,35	-	5,50	3,50	1,60	6,40	0,37	0,25	2,30
RCMT 2006M0-ST	RCMT 2006M0-ST	20,00	6,35	-	6,50	4,00	2,00	8,00	0,45	0,30	3,00
RCMT 2507M0-RF	RCMT 2507M0-RF	25,00	7,94	-	7,20	6,30	2,50	10,00	0,79	0,25	2,50
RCMT 2006M0-RM	RCMT 2006M0-RM	20,00	6,35	-	6,50	4,00	2,00	8,00	0,45	0,13	0,63
RCMX 1003M0-ST	RCMX 1003M0-ST	10,00	3,18	-	3,60	2,50	1,00	4,00	0,32	0,10	1,00
RCMX 1204M0-ST	RCMX 1204M0-ST	12,00	4,76	-	4,20	3,00	1,20	4,80	0,38	0,12	1,20
RCMX 1606M0-ST	RCMX 1606M0-ST	16,00	6,35	-	5,20	4,00	1,60	6,40	0,51	0,16	1,60
RCMX 2006M0-ST	RCMX 2006M0-ST	20,00	6,35	-	6,50	5,00	2,00	8,00	0,63	0,20	2,00
RCMX 2507M0-ST	RCMX 2507M0-ST	25,00	7,94	-	7,20	6,30	2,50	10,00	0,79	0,25	2,50
RCMX 3209M0-ST	RCMX 3209M0-ST	32,00	9,52	-	9,50	8,00	3,20	12,80	1,01	0,32	3,20
RCMX 3209M0-RM	RCMX 3209M0-RM	32,00	9,52	-	9,50	6,50	3,20	13,00	1,80	0,80	2,50
RCMX 2507M0-RR	RCMX 2507M0-RR	25,00	7,94	-	7,20	5,00	3,20	8,00	1,80	0,80	2,50
RCMX 3209M0-RR	RCMX 3209M0-RR	32,00	9,52	-	9,50	6,50	3,20	13,00	1,80	0,80	2,50

RC = ROUND R° POSITIVE

REDONDA R° POSITIVA | REDONDA R° POSITIVA

			P								M						K			N	S						
			CVD						PVD		CVD			PVD			CVD			UNC	PVD						
		(2) Grade code	T6	L7	R2	L8	R3	L9	V5	G1	G4	U4	U5	V6	G1	X6	G4	Y3	L5	L6	L9	10	G1	X6	G4	Y3	
Inserts Pastilhas Plaquitas	(1) Geometry code	ISO Reference	PHG105	PH5115	PHG115	PH5125	PHG125	PH5740	PHG140	PH7910	PH7920	PH5215	PH5225	PH5240	PH7910	PHH910	PH7920	PHH920	PH5705	PH5320	PH5740	PH0910	PH7910	PHH910	PH7920	PHH920	
 RCGT-LN Finishing to Fine Finishing	1124005	RCGT 0602M0-LN																									
	1124006	RCGT 0803M0-LN																									
	1124007	RCGT 1003M0-LN																									
	1123684	RCGT 1204M0-LN																									

- First choice | 1ª Escolha | 1ª Opción
- Stock items | Itens de stock

- Stock available until sold out | Stock disponível até acabar o stock | Stock disponible hasta acabar el stock
- Available under request | Disponível sob consulta | Disponible bajo consulta

Insert Order Code: ⁽¹⁾Geometry code + ⁽²⁾Grade code



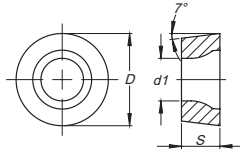



RELIEF ANGLE 7°



ISO Reference	ANSI Reference	Dimensions (mm) Dimensões (mm) Dimensiones (mm)				Cutting Conditions Condições de Corte Condiciones de Corte					
		D	S	Re	d1	ap (mm)	Min	Max	fn (mm/rev)	Min	Max
RCGT 0602M0-LN	RCGT 0602M0-LN	6,00	2,38	-	2,80	1,25	0,50	2,00	0,13	0,05	0,20
RCGT 0803M0-LN	RCGT 0803M0-LN	8,00	3,18	-	3,40	1,50	0,50	2,50	0,15	0,05	0,25
RCGT 1003M0-LN	RCGT 1003M0-LN	10,00	3,18	-	4,40	2,00	1,00	3,00	0,20	0,10	0,30
RCGT 1204M0-LN	RCGT 1204M0-LN	12,00	4,76	-	4,40	2,25	1,00	3,50	0,23	0,10	0,35

SC = SQUARE 90° POSITIVE

QUADRADA 90° POSITIVA | ESCUADRA 90° POSITIVA

			P								M						K			N	S							
			CVD					PVD			CVD			PVD			CVD			UNC	PVD							
		(2) Grade code	T6	L7	R2	L8	R3	L9	V5	G1	G4	U4	U5	V6	G1	X6	G4	Y3	L5	L6	L9	10	G1	X6	G4	Y3		
Inserts Pastilhas Plaquetas	(1) Geometry code	ISO Reference	PHG105	PH5115	PHG115	PH5125	PHG125	PH5740	PHG140	PH7910	PH7920	PHS215	PHS225	PHS240	PH7910	PHH910	PH7920	PHH920	PH5705	PH5320	PH5740	PH0910	PH7910	PHH910	PH7920	PHH920		
	SCMW	1120469	SCMW 09T304																									
		1120470	SCMW 09T308																									
	Finishing	1120472	SCMW 120408																									
	SCMT-FP	1121759	SCMT 09T304-FP																									
	Finishing	1121765	SCMT 09T308-FP																									
	SCMT-FM	1121758	SCMT 09T304-FM																									
	Finishing	1121764	SCMT 09T308-FM																									
	SCMT-FK	1121757	SCMT 09T304-FK																									
	Finishing	1121763	SCMT 09T308-FK																									
	SCMT-MP	1121762	SCMT 09T304-MP																									
		1121768	SCMT 09T308-MP																									
	Medium	1121770	SCMT 120404-MP																									
		1121783	SCMT 120408-MP																									
	SCMT-MM	1121761	SCMT 09T304-MM																									
		1121767	SCMT 09T308-MM																									
	Medium	1121769	SCMT 120404-MM																									
		1121782	SCMT 120408-MM																									
		1121784	SCMT 120412-MM																									
	SCMT-MK	1121760	SCMT 09T304-MK																									
		1121766	SCMT 09T308-MK																									
	Medium	1121781	SCMT 120408-MK																									
	SCGT-LN	1124008	SCGT 09T304-LN																									
		1124009	SCGT 09T308-LN																									
	Medium to Finishing	1124743	SCGT 120402-LN																									
		1124010	SCGT 120404-LN																									
		1123685	SCGT 120408-LN																									

🔴 First choice | 1ª Escolha | 1ª Opción

🟩 Stock available until sold out | Stock disponível até acabar o stock | Stock disponible hasta acabar el stock

Insert Order Code: (1) Geometry code + (2) Grade code

🟦 Stock Items | Itens de stock

🟨 Available under request | Disponível sob consulta | Disponible bajo consulta

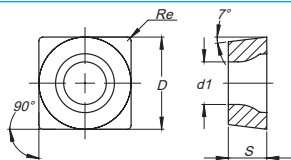

RELIEF ANGLE 7°



ISO Reference	ANSI Reference	Dimensions (mm) Dimensões (mm) Dimensiones (mm)				Cutting Conditions Condições de Corte Condiciones de Corte					
		D	S	Re	d1	ap (mm)	Min	Max	fn (mm/rev)	Min	Max
SCMW 09T304	SCMW 32.51	9,525	3,97	0,40	4,40	2,40	0,05	4,70	0,20	0,08	0,26
SCMW 09T308	SCMW 32.52	9,525	3,97	0,80	4,40	2,40	0,05	4,70	0,40	0,16	0,53
SCMW 120408	SCMW 432	12,700	4,76	0,80	5,50	3,20	0,05	6,30	0,40	0,16	0,53
SCMT 09T304-FP	SCMT 32.51-FP	9,525	3,97	0,40	4,40	0,35	0,11	2,00	0,11	0,06	0,23
SCMT 09T308-FP	SCMT 32.52-FP	9,525	3,97	0,80	4,40	0,35	0,15	2,00	0,15	0,08	0,30
SCMT 09T304-FM	SCMT 32.51-FM	9,525	3,97	0,40	4,40	0,35	0,11	2,00	0,11	0,06	0,23
SCMT 09T308-FM	SCMT 32.52-FM	9,525	3,97	0,80	4,40	0,35	0,15	2,00	0,15	0,08	0,30
SCMT 09T304-FK	SCMT 32.51-FK	9,525	3,97	0,40	4,40	0,35	0,11	2,00	0,11	0,06	0,23
SCMT 09T308-FK	SCMT 32.52-FK	9,525	3,97	0,80	4,40	0,35	0,15	2,00	0,15	0,08	0,30
SCMT 09T304-MP	SCMT 32.51-MP	9,525	3,97	0,40	4,40	0,80	0,25	3,00	0,15	0,08	0,23
SCMT 09T308-MP	SCMT 32.52-MP	9,525	3,97	0,80	4,40	0,80	0,50	3,00	0,25	0,10	0,40
SCMT 120404-MP	SCMT 431-MP	12,700	4,76	0,40	5,50	0,96	0,30	3,60	0,18	0,09	0,27
SCMT 120408-MP	SCMT 432-MP	12,700	4,76	0,80	5,50	0,96	0,60	3,60	0,25	0,12	0,45
SCMT 120412-MP	SCMT 433-MP	12,700	4,76	1,20	5,50	0,96	0,72	3,60	0,35	0,14	0,60
SCMT 09T304-MM	SCMT 32.51-MM	9,525	3,97	0,40	4,40	0,80	0,25	3,00	0,15	0,08	0,23
SCMT 09T308-MM	SCMT 32.52-MM	9,525	3,97	0,80	4,40	0,80	0,50	3,00	0,25	0,10	0,40
SCMT 120404-MM	SCMT 431-MM	12,700	4,76	0,40	5,50	0,96	0,30	3,60	0,18	0,09	0,27
SCMT 120408-MM	SCMT 432-MM	12,700	4,76	0,80	5,50	0,96	0,60	3,60	0,25	0,12	0,45
SCMT 120412-MM	SCMT 433-MM	12,700	4,76	1,20	5,50	0,96	0,72	3,60	0,35	0,14	0,60
SCMT 09T304-MK	SCMT 32.51-MK	9,525	3,97	0,40	4,40	0,80	0,25	3,00	0,15	0,08	0,23
SCMT 09T308-MK	SCMT 32.52-MK	9,525	3,97	0,80	4,40	0,80	0,50	3,00	0,25	0,10	0,40
SCMT 120408-MK	SCMT 432-MK	12,700	4,76	0,80	5,50	0,96	0,60	3,60	0,25	0,12	0,45
SCGT 09T304-LN	SCGT 32.51-LN	9,525	3,97	0,40	4,40	2,05	0,10	4,00	0,16	0,10	0,26
SCGT 09T308-LN	SCGT 32.52-LN	9,525	3,97	0,80	4,40	2,55	0,10	5,00	0,22	0,15	0,40
SCGT 120402-LN	SCGT 430.5-LN	12,700	4,76	0,20	5,50	2,50	0,10	4,50	0,15	0,08	0,25
SCGT 120404-LN	SCGT 431-LN	12,700	4,76	0,40	5,50	2,55	0,10	5,00	0,20	0,10	0,26
SCGT 120408-LN	SCGT 432-LN	12,700	4,76	0,80	5,50	2,55	0,10	5,00	0,30	0,15	0,50

SP = SQUARE 90° POSITIVE

QUADRADA 90° POSITIVA | ESCUADRA 90° POSITIVA

			P								M				K			N	S							
			CVD					PVD	CVD			PVD		CVD			UNC	PVD								
		(2) Grade code	T6	L7	R2	L8	R3	L9	V5	G1	G4	U4	U5	V6	G1	X6	G4	Y3	L5	L6	L9	10	G1	X6	G4	Y3
Inserts Pastilhas Plaquitas	(1) Geometry code	ISO Reference	PHG105	PH5115	PHG115	PH5125	PHG125	PH5740	PHG140	PH7910	PH7920	PHS215	PHS225	PHS240	PH7910	PHH910	PH7920	PHH920	PH5705	PH5320	PH5740	PH0910	PH7910	PHH910	PH7920	PHH920
 SPUN Medium to Finishing	1120580	SPUN 120304				⊗																				
	1120581	SPUN 120308				⊗																				
	1120583	SPUN 120312				⊗																				
 SPMR-12 Finishing to Fine Finishing	1120561	SPMR 090308-12		⊗		⊗																				
	1120563	SPMR 120304-12		⊗																						
	1120565	SPMR 120308-12		⊗																						
 SPMR-13 Medium	1120560	SPMR 090304-13		⊗		⊗																				
	1120562	SPMR 090308-13		⊗																						
	1120564	SPMR 120304-13		⊗		⊗																				
	1120566	SPMR 120308-13		⊗		⊗																				
	1120567	SPMR 120312-13		⊗		⊗																				

⊗ First choice | 1ª Escolha | 1ª Opción

⊗ Stock available until sold out | Stock disponível até acabar o stock | Stock disponible hasta acabar el stock

Insert Order Code: ⁽¹⁾Geometry code + ⁽²⁾Grade code

⊗ Stock Items | Itens de stock

○ Available under request | Disponível sob consulta | Disponible bajo consulta

RELIEF ANGLE 11°

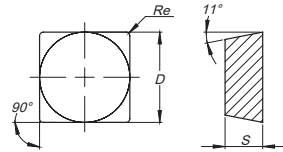

ISO Reference	ANSI Reference	Dimensions (mm) Dimensões (mm) Dimensiones (mm)				Cutting Conditions Condições de Corte Condiciones de Corte					
		D	S	Re	d1	ap (mm)	Min	Max	fn (mm/rev)	Min	Max
SPUN 120304	SPUN 421	12,700	3,18	0,40	-	3,00	1,00	5,00	0,20	0,10	0,30
SPUN 120308	SPUN 422	12,700	3,18	0,80	-	3,00	1,00	5,00	0,25	0,15	0,40
SPUN 120312	SPUN 423	12,700	3,18	1,20	-	3,00	1,00	5,00	0,35	0,20	0,50
SPMR 090308-12	SPMR 322-12	9,525	3,18	0,80	-	1,00	0,30	2,00	0,20	0,10	0,30
SPMR 120304-12	SPMR 421-12	12,700	3,18	0,40	-	1,30	0,50	2,00	0,15	0,08	0,25
SPMR 120308-12	SPMR 422-12	12,700	3,18	0,80	-	1,30	0,50	2,00	0,22	0,10	0,30
SPMR 090304-13	SPMR 321-13	9,525	3,18	0,40	-	2,20	1,00	3,50	0,10	0,05	0,20
SPMR 090308-13	SPMR 322-13	9,525	3,18	0,80	-	2,20	1,00	3,50	0,25	0,10	0,40
SPMR 120304-13	SPMR 421-13	12,700	3,18	0,40	-	2,60	1,50	4,00	0,10	0,07	0,20
SPMR 120308-13	SPMR 422-13	12,700	3,18	0,80	-	2,60	1,50	4,00	0,30	0,20	0,40
SPMR 120312-13	SPMR-423-13	12,700	3,18	1,20	-	2,60	1,50	4,00	0,40	0,25	0,55

TC = TRIANGULAR 60° POSITIVE

TRIANGULAR 60° POSITIVA | TRIANGULAR 60° POSITIVA

			P								M						K			N	S						
			CVD						PVD		CVD			PVD			CVD			UNC	PVD						
		(2) Grade code	T6	L7	R2	L8	R3	L9	V5	G1	G4	U4	U5	V6	G1	X6	G4	Y3	L5	L6	L9	10	G1	X6	G4	Y3	
Inserts Pastilhas Plaquitas	(1) Geometry code	ISO Reference	PHG105	PH5115	PHG115	PH5125	PHG125	PH5740	PHG140	PH7910	PH7920	PHS215	PHS225	PHS240	PH7910	PHH910	PH7920	PHH920	PH5705	PH5320	PH5740	PH0910	PH7910	PHH910	PH7920	PHH920	
TCMW 	1120620	TCMW 110204																	⊗								
	1120622	TCMW 16T304																	⊗								
	Finishing	1120623	TCMW 16T308																⊗								
TCMT-FP 	1121788	TCMT 06T102-FP					⊗																				
	1121798	TCMT 06T104-FP			⊗	⊗	⊗																				
	1121801	TCMT 06T108-FP	⊗	⊗	⊗	⊗																					
	Finishing	1121804	TCMT 090202-FP				⊗	⊗																			
		1121807	TCMT 090204-FP	⊗	⊗		⊗																				
	1121961	TCMT 110202-FP					⊗																				
	1121962	TCMT 110204-FP			⊗		⊗																				
	1121963	TCMT 110208-FP	⊗	⊗	⊗	⊗																					
	1121669	TCMT 110302-FP				⊗	⊗																				
	1121816	TCMT 110304-FP			⊗	⊗	⊗																				
1121823	TCMT 110308-FP	⊗	⊗	⊗	⊗																						
1121832	TCMT 16T304-FP			⊗		⊗																					
TCMT-FM 	1121787	TCMT 06T102-FM										⊗						⊗								⊗	
	1121797	TCMT 06T104-FM										⊗						⊗								⊗	
	1123637	TCMT 06T108-FM										⊗						⊗								⊗	
	Finishing	1121803	TCMT 090202-FM										⊗						⊗	⊗	⊗				⊗	⊗	⊗
		1121806	TCMT 090204-FM										⊗						⊗	⊗	⊗				⊗	⊗	⊗
	1121960	TCMT 110202-FM										⊗						⊗	⊗	⊗				⊗	⊗	⊗	
	1121958	TCMT 110204-FM										⊗						⊗	⊗	⊗				⊗	⊗	⊗	
	1121959	TCMT 110208-FM										⊗						⊗							⊗	⊗	
	1121881	TCMT 110302-FM										⊗						⊗							⊗	⊗	
	1121815	TCMT 110304-FM										⊗						⊗							⊗	⊗	
1121822	TCMT 110308-FM										⊗						⊗							⊗	⊗		
1121831	TCMT 16T304-FM										⊗						⊗	⊗	⊗				⊗	⊗	⊗		

⊗ First choice | 1ª Escolha | 1ª Opción

⊗ Stock available until sold out | Stock disponible até acabar o stock | Stock disponible hasta acabar el stock

Insert Order Code: (1) Geometry code + (2) Grade code

⊗ Stock Items | Itens de stock

○ Available under request | Disponível sob consulta | Disponible bajo consulta



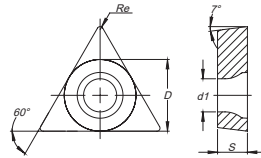

RELIEF ANGLE 7°

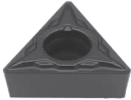

ISO Reference	ANSI Reference	Dimensions (mm) Dimensões (mm) Dimensiones (mm)				Cutting Conditions Condições de Corte Condiciones de Corte					
		D	S	Re	d1	ap (mm)	Min	Max	fn (mm/rev)	Min	Max
TCMW 110204	TCMW 21.51	6,350	2,38	0,40	2,80	1,50	0,05	3,10	0,20	0,08	0,26
TCMW 16T304	TCMW 32.51	9,525	3,97	0,40	4,40	2,30	0,05	4,70	0,20	0,08	0,26
TCMW 16T308	TCMW 32.52	9,525	3,97	0,80	4,40	2,30	0,05	4,70	0,40	0,16	0,53
TCMT 06T102-FP	TCMT 1.21.20.5-FP	3,970	1,98	0,20	2,15	0,26	0,06	1,50	0,06	0,03	0,11
TCMT 06T104-FP	TCMT 1.21.21-FP	3,970	1,98	0,40	2,15	0,26	0,08	1,50	0,08	0,05	0,17
TCMT 06T108-FP	TCMT 1.21.22-FP	3,970	1,98	0,80	2,15	0,26	0,11	1,50	0,11	0,06	0,23
TCMT 090202-FP	TCMT 1.81.50.5-FP	5,560	2,38	0,20	2,50	0,30	0,06	1,70	0,06	0,03	0,13
TCMT 090204-FP	TCMT 1.81.51-FP	5,560	2,38	0,40	2,50	0,30	0,10	1,70	0,10	0,05	0,19
TCMT 110202-FP	TCMT 21.50.5-FP	6,350	2,38	0,20	2,80	0,30	0,06	1,70	0,06	0,03	0,13
TCMT 110204-FP	TCMT 21.51-FP	6,350	2,38	0,40	2,80	0,30	0,10	1,70	0,10	0,05	0,19
TCMT 110208-FP	TCMT 21.52-FP	6,350	2,38	0,80	2,80	0,30	0,13	1,70	0,13	0,07	0,26
TCMT 110302-FP	TCMT 220.5-FP	6,350	3,18	0,20	2,80	0,30	0,06	1,70	0,06	0,03	0,13
TCMT 110304-FP	TCMT 221-FP	6,350	3,18	0,40	2,80	0,30	0,10	1,70	0,10	0,05	0,19
TCMT 110308-FP	TCMT 222-FP	6,350	3,18	0,80	2,80	0,30	0,13	1,70	0,13	0,07	0,26
TCMT 16T304-FP	TCMT 32.51-FP	9,525	3,97	0,40	4,40	0,35	0,11	2,00	0,11	0,06	0,23
TCMT 06T102-FM	TCMT 1.21.20.5-FM	3,970	1,98	0,20	2,15	0,26	0,06	1,50	0,06	0,03	0,11
TCMT 06T104-FM	TCMT 1.21.21-FM	3,970	1,98	0,40	2,15	0,26	0,08	1,50	0,08	0,05	0,17
TCMT 06T108-FM	TCMT 1.21.22-FM	3,970	1,98	0,80	2,15	0,26	0,11	1,50	0,11	0,06	0,23
TCMT 090202-FM	TCMT 1.81.50.5-FM	5,560	2,38	0,20	2,50	0,30	0,06	1,70	0,06	0,03	0,13
TCMT 090204-FM	TCMT 1.81.51-FM	5,560	2,38	0,40	2,50	0,30	0,10	1,70	0,10	0,05	0,19
TCMT 110202-FM	TCMT 21.50.5-FM	6,350	2,38	0,20	2,80	0,30	0,06	1,70	0,06	0,03	0,13
TCMT 110204-FM	TCMT 21.51-FM	6,350	2,38	0,40	2,80	0,30	0,10	1,70	0,10	0,05	0,19
TCMT 110208-FM	TCMT 21.52-FM	6,350	2,38	0,80	2,80	0,30	0,13	1,70	0,13	0,07	0,26
TCMT 110302-FM	TCMT 220.5-FM	6,350	3,18	0,20	2,80	0,30	0,06	1,70	0,06	0,03	0,13
TCMT 110304-FM	TCMT 221-FM	6,350	3,18	0,40	2,80	0,30	0,10	1,70	0,10	0,05	0,19
TCMT 110308-FM	TCMT 222-FM	6,350	3,18	0,80	2,80	0,30	0,13	1,70	0,13	0,07	0,26
TCMT 16T304-FM	TCMT 32.51-FM	9,525	3,97	0,40	4,40	0,35	0,11	2,00	0,11	0,06	0,23

TC = TRIANGULAR 60° POSITIVE

TRIANGULAR 60° POSITIVA | TRIANGULAR 60° POSITIVA

			P								M						K			N	S						
			CVD					PVD			CVD			PVD			CVD			UNC	PVD						
		(2) Grade code	T6	L7	R2	L8	R3	L9	V5	G1	G4	U4	U5	V6	G1	X6	G4	Y3	L5	L6	L9	10	G1	X6	G4	Y3	
Inserts Pastilhas Plaquitas	(1) Geometry code	ISO Reference	PHG105	PH5115	PHG115	PH5125	PHG125	PH5740	PHG140	PH7910	PH7920	PHS215	PHS225	PHS240	PH7910	PHH910	PH7920	PHH920	PH5705	PH5320	PH5740	PH0910	PH7910	PHH910	PH7920	PHH920	
 TCMT-FK Finishing	1121786	TCMT 06T102-FK																	⊗	⊗	⊗						
	1121789	TCMT 06T104-FK																	⊗	⊗	⊗						
	1121800	TCMT 06T108-FK																	⊗	⊗	⊗						
	1123668	TCMT 090202-FK																	⊗	⊗	⊗						
	1121805	TCMT 090204-FK																	⊗	⊗	⊗						
	1121956	TCMT 110202-FK																	⊗	⊗	⊗						
	1121957	TCMT 110204-FK																	⊗	⊗	⊗						
	1121813	TCMT 110302-FK																	⊗	⊗	⊗						
1121814	TCMT 110304-FK																	⊗	⊗	⊗							
1121830	TCMT 16T304-FK																	⊗	⊗	⊗							
 TCMT-FW Finishing Wiper	1121808	TCMT 090204-FW	⊗	⊗														⊗	⊗	⊗					⊗		
	1121809	TCMT 090208-FW	⊗	⊗															⊗	⊗	⊗					⊗	
	1121964	TCMT 110204-FW	⊗	⊗															⊗	⊗	⊗					⊗	
	1121965	TCMT 110208-FW	⊗	⊗															⊗	⊗	⊗					⊗	
	1121817	TCMT 110304-FW	⊗	⊗															⊗	⊗	⊗					⊗	
	1121824	TCMT 110308-FW	⊗	⊗															⊗	⊗	⊗					⊗	
 TCMT-MP Medium	1121833	TCMT 16T304-FW			⊗													⊗	⊗	⊗					⊗		
	1121837	TCMT 16T308-FW			⊗														⊗	⊗	⊗					⊗	
 TCMT-MP Medium	1121703	TCMT 090204-MP			⊗		⊗												⊗	⊗	⊗					⊗	
	1121812	TCMT 090208-MP		⊗	⊗		⊗													⊗	⊗	⊗					⊗
	1121970	TCMT 110204-MP			⊗		⊗				⊗									⊗	⊗	⊗					⊗
	1121971	TCMT 110208-MP		⊗	⊗		⊗				⊗									⊗	⊗	⊗					⊗
	1121972	TCMT 110212-MP		⊗	⊗	⊗	⊗													⊗	⊗	⊗					⊗
	1121820	TCMT 110304-MP		⊗	⊗	⊗	⊗													⊗	⊗	⊗					⊗
	1121827	TCMT 110308-MP		⊗	⊗	⊗	⊗													⊗	⊗	⊗					⊗
	1121829	TCMT 110312-MP		⊗	⊗	⊗	⊗													⊗	⊗	⊗					⊗
 TCMT-MP Medium	1121836	TCMT 16T304-MP			⊗		⊗												⊗	⊗	⊗					⊗	
	1121840	TCMT 16T308-MP			⊗		⊗				⊗									⊗	⊗	⊗					⊗
	1121844	TCMT 16T312-MP		⊗	⊗		⊗													⊗	⊗	⊗					⊗
	1121849	TCMT 220408-MP		⊗	⊗		⊗			⊗										⊗	⊗	⊗					⊗

⊗ First choice | 1ª Escolha | 1ª Opción

⊗ Stock available until sold out | Stock disponible até acabar o stock | Stock disponible hasta acabar el stock

Insert Order Code: ⁽¹⁾ Geometry code + ⁽²⁾ Grade code

⊗ Stock Items | Itens de stock

○ Available under request | Disponível sob consulta | Disponible bajo consulta

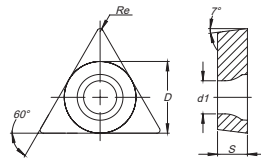

RELIEF ANGLE 7°



ISO Reference	ANSI Reference	Dimensions (mm) Dimensões (mm) Dimensiones (mm)				Cutting Conditions Condições de Corte Condiciones de Corte					
		D	S	Re	d1	ap (mm)	Min	Max	fn (mm/rev)	Min	Max
TCMT 06T102-FK	TCMT 1.21.20.5-FK	3,970	1,98	0,20	2,15	0,26	0,06	1,50	0,06	0,03	0,11
TCMT 06T104-FK	TCMT 1.21.21-FK	3,970	1,98	0,40	2,15	0,26	0,08	1,50	0,08	0,05	0,17
TCMT 06T108-FK	TCMT 1.21.22-FK	3,970	1,98	0,80	2,15	0,26	0,11	1,50	0,11	0,06	0,23
TCMT 090202-FK	TCMT 1.81.50.5-FK	5,560	2,38	0,20	2,50	0,30	0,06	1,70	0,06	0,03	0,13
TCMT 090204-FK	TCMT 1.81.51-FK	5,560	2,38	0,40	2,50	0,30	0,10	1,70	0,10	0,05	0,19
TCMT 110202-FK	TCMT 21.50.5-FK	6,350	2,38	0,20	2,80	0,30	0,06	1,70	0,06	0,03	0,13
TCMT 110204-FK	TCMT 21.51-FK	6,350	2,38	0,40	2,80	0,30	0,10	1,70	0,10	0,05	0,19
TCMT 110302-FK	TCMT 220.5-FK	6,350	3,18	0,20	2,80	0,30	0,06	1,70	0,06	0,03	0,13
TCMT 110304-FK	TCMT 221-FK	6,350	3,18	0,40	2,80	0,30	0,10	1,70	0,10	0,05	0,19
TCMT 16T304-FK	TCMT 32.51-FK	9,525	3,97	0,40	4,40	0,35	0,11	2,00	0,11	0,06	0,23
TCMT 090204-FW	TCMT 1.81.51-FW	5,560	2,38	0,40	2,50	0,70	0,30	2,00	0,12	0,05	0,30
TCMT 090208-FW	TCMT 1.81.52-FW	5,560	2,38	0,80	2,50	0,70	0,30	2,00	0,25	0,10	0,35
TCMT 110204-FW	TCMT 21.51-FW	6,350	2,38	0,40	2,80	1,00	0,30	2,50	0,20	0,07	0,30
TCMT 110208-FW	TCMT 21.52-FW	6,350	2,38	0,80	2,80	1,00	0,30	2,50	0,25	0,12	0,40
TCMT 110304-FW	TCMT 221-FW	6,350	3,18	0,40	2,80	1,00	0,30	2,50	0,20	0,07	0,30
TCMT 110308-FW	TCMT 222-FW	6,350	3,18	0,80	2,80	1,00	0,30	2,50	0,25	0,12	0,40
TCMT 16T304-FW	TCMT 32.51-FW	9,525	3,97	0,40	4,40	1,20	0,30	3,50	0,20	0,07	0,35
TCMT 16T308-FW	TCMT 32.52-FW	9,525	3,97	0,80	4,40	1,20	0,30	3,50	0,25	0,12	0,50
TCMT 090204-MP	TCMT 1.81.51-MP	5,560	2,38	0,40	2,50	0,60	0,19	2,25	0,11	0,06	0,17
TCMT 090208-MP	TCMT 1.81.52-MP	5,560	2,38	0,80	2,50	0,60	0,38	2,25	0,15	0,08	0,23
TCMT 110204-MP	TCMT 21.51-MP	6,350	2,38	0,40	2,80	0,67	0,21	2,50	0,13	0,06	0,19
TCMT 110208-MP	TCMT 21.52-MP	6,350	2,38	0,80	2,80	0,67	0,42	2,50	0,17	0,09	0,26
TCMT 110212-MP	TCMT 21.53-MP	6,350	2,38	1,20	2,80	0,67	0,50	2,50	0,20	0,10	0,40
TCMT 110304-MP	TCMT 221-MP	6,350	3,18	0,40	2,80	0,67	0,21	2,50	0,13	0,06	0,19
TCMT 110308-MP	TCMT 222-MP	6,350	3,18	0,80	2,80	0,67	0,42	2,50	0,20	0,09	0,40
TCMT 110312-MP	TCMT 223-MP	6,350	3,18	1,20	2,80	0,67	0,50	2,50	0,30	0,10	0,50
TCMT 16T304-MP	TCMT 32.51-MP	9,525	3,97	0,40	4,40	0,80	0,25	3,00	0,15	0,08	0,25
TCMT 16T308-MP	TCMT 32.52-MP	9,525	3,97	0,80	4,40	0,80	0,50	3,00	0,22	0,10	0,45
TCMT 16T312-MP	TCMT 32.53-MP	9,525	3,97	1,20	4,40	0,80	0,60	3,00	0,35	0,12	0,60
TCMT 220408-MP	TCMT 432-MP	12,700	4,76	0,80	5,50	0,96	0,60	3,60	0,25	0,12	0,45

TC = TRIANGULAR 60° POSITIVE

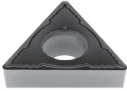
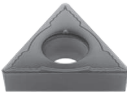
TRIANGULAR 60° POSITIVA | TRIANGULAR 60° POSITIVA

			P								M				K			N	S							
			CVD					PVD			CVD			PVD		CVD	UNC	PVD								
		(2) Grade code	T6	L7	R2	L8	R3	L9	V5	G1	G4	U4	U5	V6	G1	X6	G4	Y3	L5	L6	L9	10	G1	X6	G4	Y3
Inserts Pastilhas Plaquitas	(1) Geometry code	ISO Reference	PHG105	PH5115	PHG115	PH5125	PHG125	PH5740	PHG140	PH7910	PH7920	PHS215	PHS225	PHS240	PH7910	PHH910	PH7920	PHH920	PH5705	PH5320	PH5740	PH0910	PH7910	PHH910	PH7920	PHH920
 Medium	1121702	TCMT 090204-MM										⊗				⊗	⊗							⊗	⊗	⊗
	1121811	TCMT 090208-MM										⊗				⊗	⊗							⊗	⊗	⊗
	1121968	TCMT 110204-MM										⊗			⊗	⊗	⊗						⊗	⊗	⊗	⊗
	1121969	TCMT 110208-MM										⊗				⊗	⊗							⊗	⊗	⊗
	1121819	TCMT 110304-MM										⊗					⊗								⊗	
	1121826	TCMT 110308-MM										⊗					⊗								⊗	
	1121835	TCMT 16T304-MM										⊗				⊗	⊗	⊗						⊗	⊗	⊗
	1121839	TCMT 16T308-MM										⊗			⊗	⊗	⊗						⊗	⊗	⊗	⊗
	1121843	TCMT 16T312-MM										⊗				⊗	⊗							⊗	⊗	⊗
	1121848	TCMT 220408-MM										⊗						⊗							⊗	
 Medium	1121701	TCMT 090204-MK																	⊗	⊗						
	1121810	TCMT 090208-MK																	⊗	⊗						
	1121966	TCMT 110204-MK																	⊗	⊗						
	1121967	TCMT 110208-MK																	⊗	⊗						
	1121818	TCMT 110304-MK																	⊗	⊗						
	1121825	TCMT 110308-MK																	⊗	⊗						
	1121834	TCMT 16T304-MK																	⊗	⊗						
	1121838	TCMT 16T308-MK																	⊗	⊗						
	1121842	TCMT 16T312-MK																	⊗	⊗						
	1121847	TCMT 220408-MK																	⊗	⊗						
 Medium to Finishing Wiper	1121974	TCMT 110208-MW		⊗	⊗														⊗	⊗					⊗	
	1121828	TCMT 110308-MW		⊗	⊗															⊗	⊗					⊗
	1121841	TCMT 16T308-MW		⊗	⊗															⊗	⊗					⊗

⊗ First choice | 1ª Escolha | 1ª Opción

⊗ Stock available until sold out | Stock disponible até acabar o stock | Stock disponible hasta acabar el stock

Insert Order Code: (1) Geometry code + (2) Grade code

⊗ Stock Items | Itens de stock

○ Available under request | Disponível sob consulta | Disponible bajo consulta

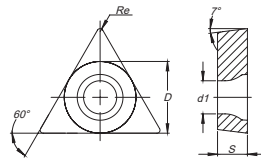

RELIEF ANGLE 7°



ISO Reference	ANSI Reference	Dimensions (mm) Dimensões (mm) Dimensiones (mm)				Cutting Conditions Condições de Corte Condiciones de Corte					
		D	S	Re	d1	ap (mm)	Min	Max	fn (mm/rev)	Min	Max
TCMT 090204-MM	TCMT 1.81.51-MM	5,560	2,38	0,40	2,50	0,60	0,19	2,25	0,11	0,06	0,17
TCMT 090208-MM	TCMT 1.81.52-MM	5,560	2,38	0,80	2,50	0,60	0,38	2,25	0,15	0,08	0,23
TCMT 110204-MM	TCMT 21.51-MM	6,350	2,38	0,40	2,80	0,67	0,21	2,50	0,13	0,06	0,19
TCMT 110208-MM	TCMT 21.52-MM	6,350	2,38	0,80	2,80	0,67	0,42	2,50	0,17	0,09	0,26
TCMT 110304-MM	TCMT 221-MM	6,350	3,18	0,40	2,80	0,67	0,21	2,50	0,13	0,06	0,19
TCMT 110308-MM	TCMT 222-MM	6,350	3,18	0,80	2,80	0,67	0,42	2,50	0,20	0,09	0,40
TCMT 16T304-MM	TCMT 32.51-MM	9,525	3,97	0,40	4,40	0,80	0,25	3,00	0,15	0,08	0,23
TCMT 16T308-MM	TCMT 32.52-MM	9,525	3,97	0,80	4,40	0,80	0,50	3,00	0,22	0,10	0,45
TCMT 16T312-MM	TCMT 32.53-MM	9,525	3,97	1,20	4,40	0,80	0,60	3,00	0,35	0,12	0,60
TCMT 220408-MM	TCMT 432-MM	12,700	4,76	0,80	5,50	0,96	0,60	3,60	0,25	0,12	0,45
TCMT 090204-MK	TCMT 1.81.51-MK	5,560	2,38	0,40	2,50	0,60	0,19	2,25	0,11	0,06	0,17
TCMT 090208-MK	TCMT 1.81.52-MK	5,560	2,38	0,80	2,50	0,60	0,38	2,25	0,15	0,08	0,23
TCMT 110204-MK	TCMT 21.51-MK	6,350	2,38	0,40	2,80	0,67	0,21	2,50	0,13	0,06	0,19
TCMT 110208-MK	TCMT 21.52-MK	6,350	2,38	0,80	2,80	0,67	0,42	2,50	0,17	0,09	0,26
TCMT 110304-MK	TCMT 221-MK	6,350	3,18	0,40	2,80	0,67	0,21	2,50	0,13	0,06	0,19
TCMT 110308-MK	TCMT 222-MK	6,350	3,18	0,80	2,80	0,67	0,42	2,50	0,20	0,09	0,40
TCMT 16T304-MK	TCMT 32.51-MK	9,525	3,97	0,40	4,40	0,80	0,25	3,00	0,15	0,08	0,23
TCMT 16T308-MK	TCMT 32.52-MK	9,525	3,97	0,80	4,40	0,80	0,50	3,00	0,22	0,10	0,45
TCMT 16T312-MK	TCMT 32.53-MK	9,525	3,97	1,20	4,40	0,80	0,60	3,00	0,35	0,12	0,60
TCMT 220408-MK	TCMT 432-MK	12,700	4,76	0,80	5,50	0,96	0,60	3,60	0,25	0,12	0,45
TCMT 110208-MW	TCMT 21.52-MW	6,350	2,38	0,80	2,80	1,20	0,50	3,00	0,30	0,15	0,50
TCMT 110308-MW	TCMT 222-MW	6,350	3,18	0,80	2,80	1,20	0,50	3,00	0,30	0,15	0,50
TCMT 16T308-MW	TCMT 32.52-MW	9,525	3,97	0,80	4,40	1,50	0,50	4,00	0,30	0,15	0,50

TC = TRIANGULAR 60° POSITIVE

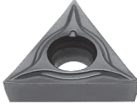
TRIANGULAR 60° POSITIVA | TRIANGULAR 60° POSITIVA

			P								M				K			N	S										
			CVD					PVD			CVD				PVD			CVD	UNC	PVD									
		(2) Grade code	T6	L7	R2	L8	R3	L9	V5	G1	G4	U4	U5	V6	G1	X6	G4	Y3	L5	L6	L9	10	G1	X6	G4	Y3			
Inserts Pastilhas Plaquitas	(1) Geometry code	ISO Reference	PHG105	PH5115	PHG115	PH5125	PHG125	PH5740	PHG140	PH7910	PH7920	PHS215	PHS225	PHS240	PH7910	PHH910	PH7920	PHH920	PH5705	PH5320	PH5740	PH0910	PH7910	PHH910	PH7920	PHH920			
 <p>Finishing to Fine Finishing</p>	TCGT-FS	1123865	TCGT 090202-FS																										
		1123866	TCGT 090204-FS																										
		1123867	TCGT 110201-FS																										
		1123868	TCGT 110202-FS																										
		1123869	TCGT 110204-FS																										
		1123870	TCGT 110301-FS																										
		1123871	TCGT 110302-FS																										
		1123872	TCGT 110304-FS																										
 <p>Medium to Finishing</p>	TCGT-LN	1124011	TCGT 090202-LN																										
		1123683	TCGT 090204-LN																										
		1121895	TCGT 110202-LN																										
		1121896	TCGT 110204-LN																										
		1124012	TCGT 110208-LN																										
		1121897	TCGT 16T302-LN																										
		1121898	TCGT 16T304-LN																										
		1121899	TCGT 16T308-LN																										
	1124013	TCGT 16T312-LN																											
	1124014	TCGT 16T316-LN																											

⊗ First choice | 1ª Escolha | 1ª Opción
 ⊗ Stock available until sold out | Stock disponível até acabar o stock | Stock disponible hasta acabar el stock
 Insert Order Code: ⁽¹⁾ Geometry code + ⁽²⁾ Grade code
⊗ Stock Items | Itens de stock
 ○ Available under request | Disponível sob consulta | Disponible bajo consulta

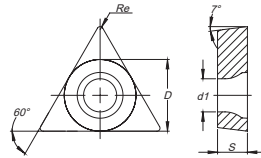

RELIEF ANGLE 7°



ISO Reference	ANSI Reference	Dimensions (mm) Dimensões (mm) Dimensiones (mm)				Cutting Conditions Condições de Corte Condiciones de Corte					
		D	S	Re	d1	ap (mm)	Min	Max	fn (mm/rev)	Min	Max
TCGT 090202-FS	TCGT 1.81.50.5-FS	5,560	2,38	0,20	2,50	0,50	0,10	1,50	0,07	0,02	0,12
TCGT 090204-FS	TCGT 1.81.51-FS	5,560	2,38	0,40	2,50	1,00	0,50	2,00	0,15	0,08	0,25
TCGT 110201-FS	TCGT 21.50.2-FS	6,350	2,38	0,10	2,80	0,30	0,10	1,00	0,03	0,01	0,08
TCGT 110202-FS	TCGT 21.50.5-FS	6,350	2,38	0,20	2,80	0,50	0,10	1,50	0,07	0,02	0,12
TCGT 110204-FS	TCGT 21.51-FS	6,350	2,38	0,40	2,80	1,30	0,30	2,50	0,15	0,08	0,25
TCGT 110301-FS	TCGT 220.2-FS	9,525	3,18	0,10	2,80	0,30	0,10	1,00	0,03	0,01	0,08
TCGT 110302-FS	TCGT 220.5-FS	9,525	3,18	0,20	2,80	0,50	0,10	1,50	0,07	0,02	0,12
TCGT 110304-FS	TCGT 221-FS	9,525	3,18	0,40	2,80	1,30	0,50	2,50	0,15	0,08	0,25
TCGT 090202-LN	TCGT 1.81.50.5-LN	5,560	2,38	0,20	2,50	1,00	0,05	2,50	0,10	0,07	0,15
TCGT 090204-LN	TCGT 1.81.51-LN	5,560	2,38	0,40	2,50	1,00	0,05	2,50	0,15	0,10	0,20
TCGT 110202-LN	TCGT 21.50.5-LN	6,350	2,38	0,20	2,80	2,03	0,05	4,00	0,12	0,07	0,15
TCGT 110204-LN	TCGT 21.51-LN	6,350	2,38	0,40	2,80	2,05	0,10	4,00	0,15	0,10	0,20
TCGT 110208-LN	TCGT 21.52-LN	6,350	2,38	0,80	2,80	2,05	0,10	4,00	0,25	0,15	0,50
TCGT 16T302-LN	TCGT 32.50.5-LN	9,525	3,97	0,20	4,40	2,53	0,05	5,00	0,10	0,07	0,15
TCGT 16T304-LN	TCGT 32.51-LN	9,525	3,97	0,40	4,40	2,80	0,10	5,50	0,15	0,10	0,20
TCGT 16T308-LN	TCGT 32.52-LN	9,525	3,97	0,80	4,40	2,80	0,10	5,50	0,25	0,15	0,50
TCGT 16T312-LN	TCGT 32.53-LN	9,525	3,97	1,20	4,40	3,00	0,15	5,50	0,45	0,15	0,70
TCGT 16T316-LN	TCGT 32.54-LN	9,525	3,97	1,60	4,40	3,00	0,15	5,50	0,65	0,20	0,90

TP = TRIANGULAR 60° POSITIVE

TRIANGULAR 60° POSITIVA | TRIANGULAR 60° POSITIVA

			P								M				K			N	S							
			CVD					PVD			CVD			PVD		CVD			UNC	PVD						
		(2) Grade code	T6	L7	R2	L8	R3	L9	V5	G1	G4	U4	U5	V6	G1	X6	G4	Y3	L5	L6	L9	10	G1	X6	G4	Y3
Inserts Pastilhas Plaquetas	(1) Geometry code	ISO Reference	PHG105	PH5115	PHG115	PH5125	PHG125	PH5740	PHG140	PH7910	PH7920	PHS215	PHS225	PHS240	PH7910	PHH910	PH7920	PHH920	PH5705	PH5320	PH5740	PH0910	PH7910	PHH910	PH7920	PHH920
 TPUN	1120765	TPUN 160304				⊗		⊗			⊗															
	1120766	TPUN 160308				⊗		⊗			⊗															
	1120770	TPUN 160312				⊗		⊗			⊗															
Medium to Finishing	1120777	TPUN 220404				⊗		⊗																		
	1120779	TPUN 220408				⊗		⊗																		
	1120783	TPUN 220412				⊗		⊗																		
	1120740	TPMR 110304-12		⊗		⊗																				
 TPMR-12	1120743	TPMR 110308-12		⊗		⊗																				
	1120745	TPMR 160304-12		⊗		⊗																				
Finishing to Fine Finishing	1120748	TPMR 160308-12		⊗		⊗																				
	1120734	TPMR 090204-13		⊗		⊗																				
 TPMR-13	1120741	TPMR 110304-13		⊗		⊗																				
	1120744	TPMR 110308-13		⊗		⊗																				
	1120746	TPMR 160304-13		⊗		⊗																				
Medium	1120749	TPMR 160308-13		⊗		⊗																				
	1120752	TPMR 160312-13		⊗		⊗																				
1120753	TPMR 220408-13		⊗		⊗																					

⊗ First choice | 1ª Escolha | 1ª Opción

⊗ Stock available until sold out | Stock disponible até acabar o stock | Stock disponible hasta acabar el stock

Insert Order Code: ⁽¹⁾Geometry code + ⁽²⁾Grade code

⊗ Stock Items | Itens de stock

○ Available under request | Disponível sob consulta | Disponible bajo consulta



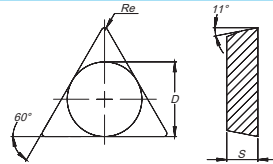



RELIEF ANGLE 11°



ISO Reference	ANSI Reference	Dimensions (mm) Dimensões (mm) Dimensiones (mm)				Cutting Conditions Condições de Corte Condiciones de Corte					
		D	S	Re	d1	ap (mm)	Min	Max	fn (mm/rev)	Min	Max
TPUN 160304	TPUN 321	9,525	3,18	0,40	-	3,50	1,00	5,00	0,15	0,10	0,30
TPUN 160308	TPUN 322	9,525	3,18	0,80	-	3,50	1,00	5,00	0,30	0,15	0,40
TPUN 160312	TPUN 323	9,525	3,18	1,20	-	3,50	1,50	5,00	0,35	0,20	0,50
TPUN 220404	TPUN 431	12,700	4,76	0,40	-	4,50	1,50	7,00	0,15	0,10	0,30
TPUN 220408	TPUN 432	12,700	4,76	0,80	-	4,50	1,50	7,00	0,30	0,15	0,40
TPUN 220412	TPUN 433	12,700	4,76	1,20	-	4,50	1,50	7,00	0,35	0,20	0,50
TPMR 110304-12	TPMR 221-12	6,350	3,18	0,40	-	0,90	0,30	1,50	0,10	0,05	0,20
TPMR 110308-12	TPMR 222-12	6,350	3,18	0,80	-	0,90	0,30	1,50	0,20	0,05	0,35
TPMR 160304-12	TPMR 321-12	9,525	3,18	0,40	-	1,30	0,50	2,00	0,12	0,08	0,20
TPMR 160308-12	TPMR 322-12	9,525	3,18	0,80	-	1,50	0,50	3,00	0,22	0,08	0,35
TPMR 090204-13	TPMR 1.81.51-13	5,560	2,38	0,40	-	1,00	0,20	1,50	0,10	0,08	0,20
TPMR 110304-13	TPMR 221-13	6,350	3,18	0,40	-	2,00	1,00	3,00	0,12	0,10	0,20
TPMR 110308-13	TPMR 222-13	6,350	3,18	0,80	-	2,00	1,00	3,00	0,25	0,13	0,40
TPMR 160304-13	TPMR 321-13	9,525	3,18	0,40	-	3,00	1,00	5,00	0,15	0,10	0,20
TPMR 160308-13	TPMR 322-13	9,525	3,18	0,80	-	3,00	1,00	5,00	0,30	0,13	0,40
TPMR 160312-13	TPMR 323-13	9,525	3,18	1,20	-	3,00	1,00	5,00	0,40	0,15	0,55
TPMR 220408-13	TPMR 432-13	12,700	4,76	0,80	-	5,00	1,50	7,00	0,30	0,15	0,40

VB = RHOMBIC 35° POSITIVE

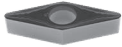
RÔMBICA 35° POSITIVA | RÓMBICA 35° POSITIVA

			P								M						K			N	S						
			CVD					PVD			CVD			PVD			CVD			UNC	PVD						
		(2) Grade code	T6	L7	R2	L8	R3	L9	V5	G1	G4	U4	U5	V6	G1	X6	G4	Y3	L5	L6	L9	10	G1	X6	G4	Y3	
Inserts Pastilhas Plaquitas	(1) Geometry code	ISO Reference	PHG105	PH5115	PHG115	PH5125	PHG125	PH5740	PHG140	PH7910	PH7920	PHS215	PHS225	PHS240	PH7910	PHH910	PH7920	PHH920	PH5705	PH5320	PH5740	PH0910	PH7910	PHH910	PH7920	PHH920	
	VBMT	1120804	VBMT 160404																								
	Finishing	1120805	VBMT 160408																								
	VBMT-FP	1121852	VBMT 110302-FP																								
	Finishing	1121855	VBMT 110304-FP																								
		1121858	VBMT 110308-FP																								
		1121859	VBMT 110312-FP																								
		1121862	VBMT 160402-FP																								
		1121865	VBMT 160404-FP																								
		1121670	VBMT 160408-FP																								
1121793	VBMT 160412-FP																										
	VBMT-FM	1121851	VBMT 110302-FM																								
	Finishing	1121854	VBMT 110304-FM																								
		1121857	VBMT 110308-FM																								
		1121861	VBMT 160402-FM																								
		1121864	VBMT 160404-FM																								
		1121870	VBMT 160408-FM																								
		1121792	VBMT 160412-FM																								
	VBMT-FK	1121850	VBMT 110302-FK																								
	Finishing	1121853	VBMT 110304-FK																								
		1121856	VBMT 110308-FK																								
		1121860	VBMT 160402-FK																								
		1121863	VBMT 160404-FK																								
1121869	VBMT 160408-FK																										
	VBMT-MP	1121868	VBMT 160404-MP																								
	Medium	1121791	VBMT 160408-MP																								
		1121796	VBMT 160412-MP																								
	VBMT-MM	1121867	VBMT 160404-MM																								
	Medium	1121790	VBMT 160408-MM																								
		1121795	VBMT 160412-MM																								
	VBMT-MK	1121866	VBMT 160404-MK																								
	Medium	1121871	VBMT 160408-MK																								
		1121794	VBMT 160412-MK																								

⊗ First choice | 1ª Escolha | 1ª Opción

⊕ Stock available until sold out | Stock disponible até acabar o stock | Stock disponible hasta acabar el stock

Insert Order Code: (1) Geometry code + (2) Grade code

⊖ Stock Items | Itens de stock

○ Available under request | Disponível sob consulta | Disponible bajo consulta



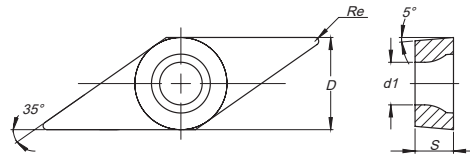



RELIEF ANGLE 5°

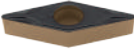

ISO Reference	ANSI Reference	Dimensions (mm) Dimensões (mm) Dimensiones (mm)				Cutting Conditions Condições de Corte Condiciones de Corte					
		D	S	Re	d1	ap (mm)	Min	Max	fn (mm/rev)	Min	Max
VBWM 160404	VBWM 331	9,525	4,76	0,40	4,40	2,30	0,05	4,70	0,20	0,10	0,26
VBWM 160408	VBWM 332	9,525	4,76	0,80	4,40	2,30	0,05	4,70	0,40	0,16	0,53
VBMT 110302-FP	VBMT 220.5-FP	6,350	3,18	0,20	2,80	0,30	0,06	1,70	0,06	0,03	0,13
VBMT 110304-FP	VBMT 221-FP	6,350	3,18	0,40	2,80	0,30	0,10	1,70	0,10	0,05	0,19
VBMT 110308-FP	VBMT 222-FP	6,350	3,18	0,80	2,80	0,30	0,13	1,70	0,13	0,07	0,26
VBMT 110312-FP	VBMT 223-FP	6,350	3,18	1,20	2,80	0,30	0,13	1,70	0,15	0,08	0,31
VBMT 160402-FP	VBMT 330.5-FP	9,525	4,76	0,20	4,40	0,32	0,07	1,80	0,07	0,04	0,14
VBMT 160404-FP	VBMT 331-FP	9,525	4,76	0,40	4,40	0,32	0,10	1,80	0,10	0,05	0,20
VBMT 160408-FP	VBMT 332-FP	9,525	4,76	0,80	4,40	0,32	0,14	1,80	0,14	0,07	0,27
VBMT 160412-FP	VBMT 333-FP	9,525	4,76	1,20	4,40	0,32	0,14	1,80	0,16	0,09	0,32
VBMT 110302-FM	VBMT 220.5-FM	6,350	3,18	0,20	2,80	0,30	0,06	1,70	0,06	0,03	0,13
VBMT 110304-FM	VBMT 221-FM	6,350	3,18	0,40	2,80	0,30	0,10	1,70	0,10	0,05	0,19
VBMT 110308-FM	VBMT 222-FM	6,350	3,18	0,80	2,80	0,30	0,13	1,70	0,13	0,07	0,26
VBMT 160402-FM	VBMT 330.5-FM	9,525	4,76	0,20	4,40	0,32	0,07	1,80	0,07	0,04	0,14
VBMT 160404-FM	VBMT 331-FM	9,525	4,76	0,40	4,40	0,32	0,10	1,80	0,10	0,05	0,20
VBMT 160408-FM	VBMT 332-FM	9,525	4,76	0,80	4,40	0,32	0,14	1,80	0,14	0,07	0,27
VBMT 160412-FM	VBMT 333-FM	9,525	4,76	1,20	4,40	0,32	0,14	1,80	0,16	0,09	0,32
VBMT 110302-FK	VBMT 220.5-FK	6,350	3,18	0,20	2,80	0,30	0,06	1,70	0,06	0,03	0,13
VBMT 110304-FK	VBMT 221-FK	6,350	3,18	0,40	2,80	0,30	0,10	1,70	0,10	0,05	0,19
VBMT 110308-FK	VBMT 222-FK	6,350	3,18	0,80	2,80	0,30	0,13	1,70	0,13	0,07	0,26
VBMT 160402-FK	VBMT 330.5-FK	9,525	4,76	0,20	4,40	0,32	0,07	1,80	0,07	0,04	0,14
VBMT 160404-FK	VBMT 331-FK	9,525	4,76	0,40	4,40	0,32	0,10	1,80	0,10	0,05	0,20
VBMT 160408-FK	VBMT 332-FK	9,525	4,76	0,80	4,40	0,32	0,14	1,80	0,14	0,07	0,27
VBMT 160404-MP	VBMT 331-MP	9,525	4,76	0,40	4,40	0,72	0,23	2,70	0,14	0,07	0,20
VBMT 160408-MP	VBMT 332-MP	9,525	4,76	0,80	4,40	0,72	0,45	2,70	0,18	0,09	0,27
VBMT 160412-MP	VBMT 333-MP	9,525	4,76	1,20	4,40	0,72	0,54	2,70	0,22	0,11	0,32
VBMT 160404-MM	VBMT 331-MM	9,525	4,76	0,40	4,40	0,72	0,23	2,70	0,14	0,07	0,20
VBMT 160408-MM	VBMT 332-MM	9,525	4,76	0,80	4,40	0,72	0,45	2,70	0,18	0,09	0,27
VBMT 160412-MM	VBMT 333-MM	9,525	4,76	1,20	4,40	0,72	0,54	2,70	0,22	0,11	0,32
VBMT 160404-MK	VBMT 331-MK	9,525	4,76	0,40	4,40	0,72	0,23	2,70	0,14	0,07	0,20
VBMT 160408-MK	VBMT 332-MK	9,525	4,76	0,80	4,40	0,72	0,45	2,70	0,18	0,09	0,27
VBMT 160412-MK	VBMT 333-MK	9,525	4,76	1,20	4,40	0,72	0,54	2,70	0,22	0,11	0,32

VC = RHOMBIC 35° POSITIVE

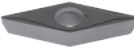
RÔMBICA 35° POSITIVA | RÓMBICA 35° POSITIVA

			P								M						K			N	S					
			CVD					PVD			CVD			PVD			CVD			UNC	PVD					
		(2) Grade code	T6	L7	R2	L8	R3	L9	V5	G1	G4	U4	U5	V6	G1	X6	G4	Y3	L5	L6	L9	10	G1	X6	G4	Y3
Inserts Pastilhas Plaquitas	(1) Geometry code	ISO Reference	PHG105	PH5115	PHG115	PH5125	PHG125	PH5740	PHG140	PH7910	PH7920	PHS215	PHS225	PHS240	PH7910	PHH910	PH7920	PHH920	PH5705	PH5320	PH5740	PH0910	PH7910	PHH910	PH7920	PHH920
VCMTW																										
	1120816	VCMTW 160404																								
Finishing																										
VCMT-FP																										
	1121776	VCMT 110302-FP																								
	1121779	VCMT 110304-FP																								
Finishing																										
	1121977	VCMT 160402-FP																								
	1121978	VCMT 160404-FP																								
	1121979	VCMT 160408-FP																								
	1121980	VCMT 160412-FP																								
VCMT-FM																										
	1121775	VCMT 110302-FM																								
	1121778	VCMT 110304-FM																								
Finishing																										
	1121981	VCMT 160402-FM																								
	1121982	VCMT 160404-FM																								
	1121983	VCMT 160408-FM																								
	1121984	VCMT 160412-FM																								
VCMT-FK																										
	1121777	VCMT 110304-FK																								
Finishing																										
	1121985	VCMT 160402-FK																								
	1121986	VCMT 160404-FK																								
	1121987	VCMT 160408-FK																								
VCMT-MP																										
	1121754	VCMT 110304-MP																								
	1121752	VCMT 110308-MP																								
Medium																										
	1121988	VCMT 160404-MP																								
	1121989	VCMT 160408-MP																								
	1121990	VCMT 160412-MP																								
VCMT-MM																										
	1121780	VCMT 110304-MM																								
	1121751	VCMT 110308-MM																								
Medium																										
	1121991	VCMT 160404-MM																								
	1121992	VCMT 160408-MM																								
	1121993	VCMT 160412-MM																								
VCMT-MK																										
	1121753	VCMT 110308-MK																								
Medium																										
	1121994	VCMT 160404-MK																								
	1121995	VCMT 160408-MK																								
	1121996	VCMT 160412-MK																								

⊕ First choice | 1ª Escolha | 1ª Opción

⊕ Stock available until sold out | Stock disponível até acabar o stock | Stock disponible hasta acabar el stock

Insert Order Code: ⁽¹⁾ Geometry code + ⁽²⁾ Grade code

⊖ Stock Items | Itens de stock

○ Available under request | Disponível sob consulta | Disponible bajo consulta

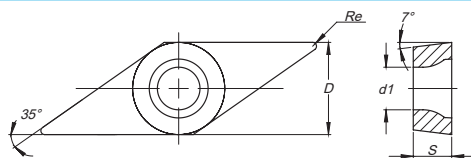

RELIEF ANGLE 7°



ISO Reference	ANSI Reference	Dimensions (mm) Dimensões (mm) Dimensiones (mm)				Cutting Conditions Condições de Corte Condiciones de Corte					
		D	S	Re	d1	ap (mm)	Min	Max	fn (mm/rev)	Min	Max
VCMW 160404	VCMW 331	9,525	4,76	0,40	4,40	2,30	0,05	4,70	0,20	0,08	0,26
VCMT 110302-FP	VCMT 220.5-FP	6,350	3,18	0,20	2,80	0,30	0,07	1,50	0,07	0,03	0,13
VCMT 110304-FP	VCMT 221-FP	6,350	3,18	0,40	2,80	0,30	0,10	1,50	0,10	0,05	0,20
VCMT 160402-FP	VCMT 330.5-FP	9,525	4,76	0,20	4,40	0,32	0,07	1,80	0,07	0,04	0,14
VCMT 160404-FP	VCMT 331-FP	9,525	4,76	0,40	4,40	0,32	0,10	1,80	0,10	0,05	0,20
VCMT 160408-FP	VCMT 332-FP	9,525	4,76	0,80	4,40	0,32	0,14	1,80	0,14	0,07	0,27
VCMT 160412-FP	VCMT 333-FP	9,525	4,76	1,20	4,40	0,32	0,14	1,80	0,16	0,09	0,32
VCMT 110302-FM	VCMT 220.5-FM	6,350	3,18	0,20	2,80	0,30	0,07	1,50	0,07	0,03	0,13
VCMT 110304-FM	VCMT 221-FM	6,350	3,18	0,40	2,80	0,30	0,10	1,50	0,10	0,05	0,20
VCMT 160402-FM	VCMT 330.5-FM	9,525	4,76	0,20	4,40	0,32	0,07	1,80	0,07	0,04	0,14
VCMT 160404-FM	VCMT 331-FM	9,525	4,76	0,40	4,40	0,32	0,10	1,80	0,10	0,05	0,20
VCMT 160408-FM	VCMT 332-FM	9,525	4,76	0,80	4,40	0,32	0,14	1,80	0,14	0,07	0,27
VCMT 160412-FM	VCMT 333-FM	9,525	4,76	1,20	4,40	0,32	0,14	1,80	0,16	0,09	0,32
VCMT 110304-FK	VCMT 221-FK	6,350	3,18	0,40	2,80	0,30	0,10	1,50	0,10	0,05	0,20
VCMT 160402-FK	VCMT 330.5-FK	9,525	4,76	0,20	4,40	0,32	0,07	1,80	0,07	0,04	0,14
VCMT 160404-FK	VCMT 331-FK	9,525	4,76	0,40	4,40	0,32	0,10	1,80	0,10	0,05	0,20
VCMT 160408-FK	VCMT 332-FK	9,525	4,76	0,80	4,40	0,32	0,14	1,80	0,14	0,07	0,27
VCMT 110304-MP	VCMT 221-MP	6,350	3,18	0,40	2,80	0,77	0,31	2,55	0,15	0,10	0,25
VCMT 110308-MP	VCMT 222-MP	6,350	3,18	0,80	2,80	0,77	0,61	2,55	0,20	0,13	0,33
VCMT 160404-MP	VCMT 331-MP	9,525	4,76	0,40	4,40	0,72	0,23	2,70	0,14	0,07	0,20
VCMT 160408-MP	VCMT 332-MP	9,525	4,76	0,80	4,40	0,72	0,45	2,70	0,18	0,09	0,27
VCMT 160412-MP	VCMT 333-MP	9,525	4,76	1,20	4,40	0,72	0,54	2,70	0,22	0,11	0,32
VCMT 110304-MM	VCMT 221-MM	6,350	3,18	0,40	2,80	0,77	0,31	2,55	0,15	0,10	0,25
VCMT 110308-MM	VCMT 222-MM	6,350	3,18	0,80	2,80	0,77	0,61	2,55	0,20	0,13	0,33
VCMT 160404-MM	VCMT 331-MM	9,525	4,76	0,40	4,40	0,72	0,23	2,70	0,14	0,07	0,20
VCMT 160408-MM	VCMT 332-MM	9,525	4,76	0,80	4,40	0,72	0,45	2,70	0,18	0,09	0,27
VCMT 160412-MM	VCMT 333-MM	9,525	4,76	1,20	4,40	0,72	0,54	2,70	0,22	0,11	0,32
VCMT 110308-MK	VCMT 222-MK	6,350	3,18	0,80	2,80	0,77	0,61	2,55	0,20	0,13	0,33
VCMT 160404-MK	VCMT 331-MK	9,525	4,76	0,40	4,40	0,72	0,23	2,70	0,14	0,07	0,20
VCMT 160408-MK	VCMT 332-MK	9,525	4,76	0,80	4,40	0,72	0,45	2,70	0,18	0,09	0,27
VCMT 160412-MK	VCMT 333-MK	9,525	4,76	1,20	4,40	0,72	0,54	2,70	0,22	0,11	0,32

VC = RHOMBIC 35° POSITIVE

RÔMBICA 35° POSITIVA | RÓMBICA 35° POSITIVA

			P								M				K			N	S							
			CVD					PVD			CVD			PVD		CVD			UNC	PVD						
		(2) Grade code	T6	L7	R2	L8	R3	L9	V5	G1	G4	U4	U5	V6	G1	X6	G4	Y3	L5	L6	L9	10	G1	X6	G4	Y3
Inserts Pastilhas Plaquitas	(1) Geometry code	ISO Reference	PHG105	PH5115	PHG115	PH5125	PHG125	PH5740	PHG140	PH7910	PH7920	PHS215	PHS225	PHS240	PH7910	PHH910	PH7920	PHH920	PH5705	PH5320	PH5740	PH0910	PH7910	PHH910	PH7920	PHH920
 VCGT-FS Finishing to Fine Finishing	1123861	VCGT 110301-FS								⊗	⊗				⊗	⊗	⊗	⊗					⊗	⊗	⊗	⊗
	1123862	VCGT 110302-FS								⊗	⊗				⊗	⊗	⊗	⊗					⊗	⊗	⊗	⊗
	1123863	VCGT 110304-FS								⊗	⊗				⊗	⊗	⊗	⊗					⊗	⊗	⊗	⊗
 VCGT-LN Medium to Finishing	1123689	VCGT 110301-LN																				⊗				
	1121889	VCGT 110302-LN																				⊗				
	1121890	VCGT 110304-LN																				⊗				
	1121891	VCGT 110308-LN																				⊗				
	1124015	VCGT 130302-LN																				⊗				
	1124016	VCGT 130304-LN																				⊗				
	1124677	VCGT 130308-LN																				⊗				
	1111878	VCGT 160402-LN																				⊗				
	1111533	VCGT 160404-LN																⊗				⊗		⊗		
	1121893	VCGT 160408-LN																⊗				⊗		⊗		
1121894	VCGT 160412-LN																				⊗		⊗			
1121929	VCGT 220530-LN																				⊗					

⊗ First choice | 1ª Escolha | 1ª Opción

⊗ Stock available until sold out | Stock disponível até acabar o stock | Stock disponible hasta acabar el stock

Insert Order Code: ⁽¹⁾ Geometry code + ⁽²⁾ Grade code

⊗ Stock Items | Itens de stock

○ Available under request | Disponível sob consulta | Disponible bajo consulta

RELIEF ANGLE 7°

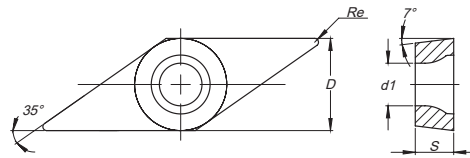

ISO Reference	ANSI Reference	Dimensions (mm) Dimensões (mm) Dimensiones (mm)				Cutting Conditions Condições de Corte Condiciones de Corte					
		D	S	Re	d1	ap (mm)	Min	Max	fn (mm/rev)	Min	Max
VCGT 110301-FS	VCGT 220.2-FS	6,350	3,18	0,10	2,80	0,30	0,10	1,00	0,03	0,01	0,08
VCGT 110302-FS	VCGT 220.5-FS	6,350	3,18	0,20	2,80	0,50	0,10	1,50	0,07	0,02	0,12
VCGT 110304-FS	VCGT 221-FS	6,350	3,18	0,40	2,80	1,00	0,30	2,50	0,15	0,08	0,25
VCGT 110301-LN	VCGT 220.2-LN	6,350	3,18	0,10	2,80	1,53	0,05	3,00	0,04	0,02	0,06
VCGT 110302-LN	VCGT 220.5-LN	6,350	3,18	0,20	2,80	1,53	0,05	3,00	0,07	0,05	0,12
VCGT 110304-LN	VCGT 221-LN	6,350	3,18	0,40	2,80	1,53	0,05	3,00	0,15	0,10	0,25
VCGT 110308-LN	VCGT 222-LN	6,350	3,18	0,80	2,80	1,53	0,05	3,00	0,22	0,15	0,45
VCGT 130302-LN	VCGT 2.520.5-LN	7,940	3,18	0,20	3,40	2,00	0,10	4,00	0,07	0,05	0,12
VCGT 130304-LN	VCGT 2.521-LN	7,940	3,18	0,40	3,40	2,00	0,10	4,00	0,15	0,10	0,25
VCGT 130308-LN	VCGT 2.522-LN	7,940	3,18	0,80	3,40	2,50	0,15	4,50	0,18	0,10	0,30
VCGT 160402-LN	VCGT 330.5-LN	9,525	4,76	0,20	4,40	2,30	0,10	5,00	0,07	0,05	0,12
VCGT 160404-LN	VCGT 331-LN	9,525	4,76	0,40	4,40	2,55	0,10	5,00	0,15	0,10	0,25
VCGT 160408-LN	VCGT 332-LN	9,525	4,76	0,80	4,40	2,55	0,10	5,00	0,22	0,15	0,45
VCGT 160412-LN	VCGT 333-LN	9,525	4,76	1,20	4,40	2,55	0,10	5,00	0,40	0,15	0,60
VCGT 220530-LN	VCGT 43.57.5-LN	12,700	5,56	3,00	5,50	3,55	0,10	7,00	0,80	0,15	1,60





TURNING

Insert selection

Overview

Negative inserts

Positive inserts

PCBN & PCD inserts

Heavy turning

External Toolholders

Internal Toolholders

Automatic Lathes

Spare Parts

Technical Data

PCBN (Polycrystalline-Cubic-Boron-Nitride) is not found in nature, it is a synthetic material which is the result of an high temperature and high pressure process (HTHP). When PCBN tips are brazed to a carbide insert a powerful cutting tool is born.

PCBN insert excel in the finishing and semi-finishing process of hardened steels (45-68 HRC) as well as hard cast iron and heat-resistant super alloys (HRSA).

Grades description:

Grade	Code	Characteristics	Application
PBY603	Y5	Low PCBN content grade with medium grain size and ceramic binder. Great wear and abrasion resistance	<ul style="list-style-type: none"> For continuously and lightly interrupted cutting of Hardened Steel (H01-H10); Finishing abrasive high strength cast irons; Can also be used to machine HRSA (S01-S10).
PBY620	Y4	Low PCBN content grade with medium grain size which provides enhanced crater and flank wear resistance with an excellent balance of toughness	<ul style="list-style-type: none"> For moderately to heavily interrupted turning of all hardened steels (H10-H20).
PBH920	S4	High PCBN with excellent abrasion resistance.	<ul style="list-style-type: none"> For machining all types of cast iron (K01-K30); First choice for machining ferrous powder metals; Can also be used to machine HRSA (S20-S30).
PBY930	W3	High abrasive Wear resistance High impact toughness	<ul style="list-style-type: none"> For Cast Iron with high Niquel and Chrome content (pumps and engine blocks)
PBY940	W4	High fracture toughness High thermal conductivity	<ul style="list-style-type: none"> For Alloy steels with high content of Cr, grey cast irons and hardened steels with Ni



The insert geometry and edge preparation are extremely important in hard part turning since they have a significant influence on tool life and productivity. Palbit product range includes standard and wiper inserts. The standard nose radius generates the lowest cutting forces and has the lowest stability requirements while wiper gives an unbeatable combination of high productivity and excellent surface finish.

A large nose radius provides a greater edge strength and therefore extended tool life. For this reason, it is advised to use the largest allowed nose radius to each process requirements.

WIPER INSERT || Pastilha wiper | Plaquita wiper

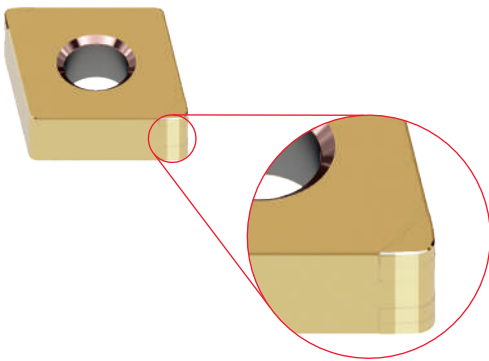

Wiper inserts provide two possibilities for process improvement:

- Improved surface finish with standard cutting data;
- Maintained surface finish at substantially higher feed rate.

	Standard ($r_{\epsilon} = 0,8\text{mm}$)	Wiper ($r_{\epsilon} = 0,8\text{mm}$)
Insert type		
Surface Roughness (R_a)	0,81 μm	0,42 μm

Note:

This values were achieved with the next cutting conditions:

H Steel HRC60 | $V_c = 130 \text{ m/min}$ | $f_n = 0,12 \text{ mm/rev}$ | $a_p = 0,2 \text{ mm}$ | $\lambda = 2,5 \text{ mm}$ / ISO 4287

FORMULAS FOR SURFACE ROUGHNESS CALCULATION

Fórmulas para calculo da rugosidade da superfície | Fórmulas para calcular la rugosidad de la superficie

$$R_a = 0,032 \times \frac{f_n^2}{r_{\epsilon}} \times 1000 \text{ } \mu\text{m}$$

$$R_t = 3,91 \times R_a \text{ } \mu\text{m}$$

R_a - Mean Surface Roughness (μm)

R_t - Roughness Total Height (μm)

f_n - Feed Rate (mm/rev)

r_{ϵ} - Insert Radius (mm)

EDGE PREPARATION SELECTION

Seleção da preparação de aresta | Selección de la preparación de arista

The most important criteria for the stability and cutting edge tool-life is to define the correct cutting edge preparation. Its choice is mainly required in order to achieve the best economical result.

Edge preparation:

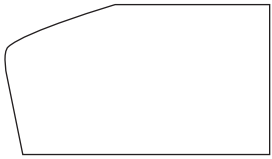
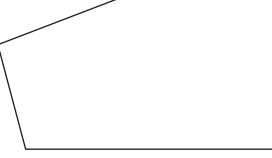
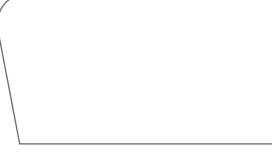
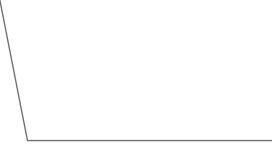
Cutting forces Edge strength ↑ + ↓ -	S-Land 	S – Preparation with chamfer and honing - Standard <ul style="list-style-type: none"> - First choice for hard part turning; - Stronger edge than T-land, with more resistance to chipping and fracture, resulting in more predictable tool life; - Generates consistent surface finish; - Critical in interrupted cutting and when using large depth of cut; - Feed rate must be greater than hone size.
	T-Land 	T – Preparation with chamfer <ul style="list-style-type: none"> - T-land is a common edge preparation for PCBN; - Preferred choice for cast iron; - Good alternative to S-land in hard part turning when reduced cutting forces and tighter tolerances are required.
	E-Land 	E – Preparation with edge honing <ul style="list-style-type: none"> - Recommended for HRSA finishing operation; - Honing helps strengthen the edge, giving resistance to chipping and fracturing; - Feed rates must be greater than the hone size to allow actual cutting action to take place and prevent rubbing.
	F-Land 	F – Preparation without honing <ul style="list-style-type: none"> - Sharp cutting edge; - F - Standard is a common edge preparation for PCD; - Recommended for aluminium or other non-ferrous materials.

Honing Types	Specifications
S3515 For interrupted machining	  Difficult Conditions
S2513 For general purpose machining	  Average Conditions
S1513 For stable continuous machining	  Good Conditions

Note: Based on our experience sometimes it is necessary to define edge preparation during several tests to provide the best possible solution for each application.

CHIP-BREAKER TAILOR-MADE

Quebra- aparas personalizados | Rompevirutas personalizados

Our laser machining and grinding machining technology can reach a wide range of tailor-made solutions. The chip-breakers can be customized according to our customer's needs and still remain with a high cutting edge quality.

PCBN RECOMMENDED CUTTING DATA







Condições de corte recomendadas para PCBN | Datos de corte recomendadas para PCBN

Workpiece material	Recommend grade for PCBN			VC (m/min)	
	PBH920	PBY603	PBY620		
Hardened Steel (HRC 45-68) Tool-Steel, Case Hardened Steel, Continuous Cut (high Economy without Coolants)		⊗		Semi-finish	80 - 200
				Finish	80 - 180
Hardened Steel (HRC 45-68) Tool-Steel, Case Hardened Steel, Interrupted Cut (recommended without Coolants)	○		⊗	Semi-finish	70 - 180
				Finish	70 - 160
Grey Cast Iron	⊗			Semi-finish	500 - 1000
				Finish	600 - 2000
High Temperature Alloys (Inconel, Waspoly, Hasteloy) Exotic and High Nickel + Cobalt basis	⊗	⊗		Finish	50 - 300

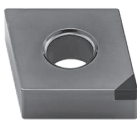
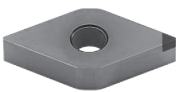
⊗ Recommended ○ Second choice

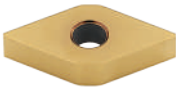
NEGATIVE INSERTS OVERVIEW

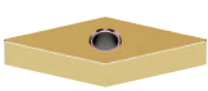
Vista genérica pastilhas negativas | Visión general de plaquitas negativas

	CNGA Z1		DNGA Z1				RNGN S ^{NEW}	
	SINGLE TIP							
	Size 12	Size 15					Size 06 09 12	
	Page 468						Page 471	
MULTIPLE TIPS	CNGA Z2 Z4	DNGA Z2 Z4	SNGA Z4	TNGA Z3 Z6	VNGA Z2	WNGA Z3 Z6		
								
	Size 12	Size 11 15	Size 12	Size 16	Size 16	Size 08		
	Page 469	Page 470	Page 471	Page 472	Page 473	Page 473		

ISO PCBN INSERTS CODE KEY

H		M	
O		V	
P		W	
S		L	
T		A	
C		B	
D		K	
E		R	
F		X	Special

1- Insert shape symbol

Symbol	m (mm)	d (mm)	s (mm)
A	±0.005	±0.025	±0.025
F	±0.005	±0.013	±0.025
C	±0.013	±0.025	±0.025
H	±0.013	±0.013	±0.025
E	±0.025	±0.025	±0.025
G	±0.025	±0.025	±0.13
J	±0.005	±0.05~±0.13	±0.025
K*	±0.013	±0.05~±0.13	±0.025
L*	±0.025	±0.05~±0.13	±0.025
M*	±0.08~±0.20	±0.05~±0.13	±0.13
N*	±0.08~±0.20	±0.05~±0.13	±0.025
U*	±0.13~±0.38	±0.08~±0.25	±0.13

Triangular inserts with a facet (secondary cutting edge)

Detailed dimension of M class insert Insert height Tolerances (mm)					
Inscribed circle					
6.35	±0.08	-	-	-	-
9.525	±0.08	±0.08	±0.11	±0.10	±0.13
12.70	±0.13	±0.13	±0.13	±0.15	-
15.875	±0.15	±0.15	±0.15	±0.18	-
19.05	±0.15	±0.15	±0.15	±0.18	-
25.40	-	±0.18	-	-	-
31.75	-	±0.25	-	-	-

Inscribed circle Tolerances (mm)					
Inscribed circle					
6.35	±0.05	-	-	-	-
9.525	±0.05	±0.05	±0.05	±0.05	±0.05
12.70	±0.08	±0.08	±0.08	±0.08	±0.08
15.875	±0.10	±0.10	±0.10	±0.10	±0.10
19.05	-	-	-	-	±0.10
25.40	-	±0.13	-	-	±0.10
31.75	-	±0.20	-	-	±0.12

3 - Tolerances symbol

As a rule, the sides of these inserts are as sintered. Tolerance differs with insert size, for the accuracy of class M, refer to the table on the right.

A	B	C	D	E
				Other clearance angle

2 - Normal clearance symbol

ISO	C	N	G	A
ANSI	C	N	G	A

4 - Insert symbol									
symbol	Type	Hole type	Chipbreaker	Shape	symbol	Type	Hole type	Chipbreaker	Shape
W	with hole	Round hole one countersink (40°-60°)	Without chipbreaker		G	with hole	Round hole	Chipbreaker on both sides	
T			Chipbreaker on one side		N	without hole	-	Without chipbreaker	
A	with hole	Round hole	Without chipbreaker		R	without hole	-	Chipbreaker on one side	
M			Chipbreaker on one side		X	-	-	-	On request

Sistema de codificação para pastilhas de PCBN
Codificación para plaquitas de plaquitas de PCBN

R's	35° V's	55° D's	80° C's	90° S's	60° T's	80° W's	IC		ANSI
							mm	inch	Symbol
-	06	04	-	03	06	02	3,97	5/32	1,20
-	08	05	04	04	08	L3	4,76	3/16	1,50
-	09	06	05	05	09	03	5,56	7/32	1,80
06**	-	-	-	-	-	-	6,00	0,236	
06*	11	07	06	06	11	04	6,35	1/4	2,00
07*	13	09	08	07	13	05	7,94	5/16	2,50
08*	-	-	-	-	-	-	8,00	0,315	
09*	16	11	09	09	16	06	9,525	3/8	3,00
10**	-	-	-	-	-	-	10,00	0,394	
12**	-	-	-	-	-	-	12,00	0,472	
12*	22	15	12	12	22	08	12,70	1/2	4,00
15*	27	19	16	15	27	10	15,875	5/8	5,00
16**	-	-	-	-	-	-	16,00	0,63	
19*	33	23	19	19	33	13	19,05	3/4	6,00
20**	-	-	-	-	-	-	20,00	0,787	
25**	-	-	-	-	-	-	25,00	0,984	
25*	44	31	25	25	44	17	25,40	1,00	8,00
31*	54	38	32	31	54	21	31,75	1 1/4	10,00
32**	-	-	-	-	-	-	32,00	1,26	

5 - Insert size symbol

* ANSI designation only
(Radius Designation is R0)

** Metric designation only
(Radius Designation is M0)

According to International Standard ISO 1832 - 2012(E)

"Indexable inserts for cutting tools - Designation"

ISO	mm	ANSI	inch
01	1.59	1	0.062
T1	1.98	1.2	0.078
02	2.38	1.5	0.094
03	3.18	2	0.125
T3	3.97	2.5	0.156
04	4.76	3	0.188
05	5.56	3.5	0.219
06	6.35	4	0.250
07	7.94	5	0.312
09	9.52	6	0.375
12	12.70	8	0.500

6 - Insert thickness symbol

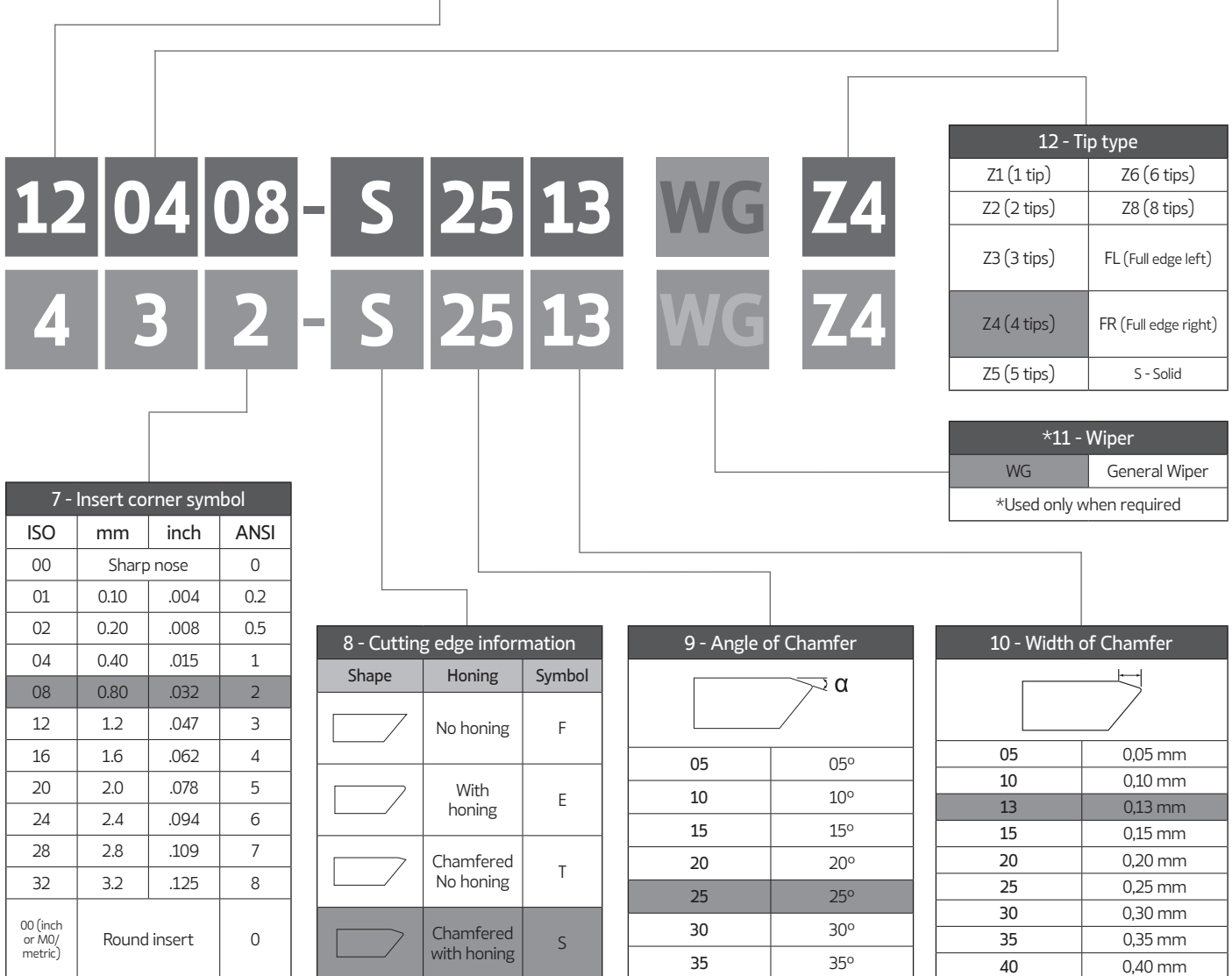

7 - Insert corner symbol			
ISO	mm	inch	ANSI
00	Sharp nose		0
01	0.10	.004	0.2
02	0.20	.008	0.5
04	0.40	.015	1
08	0.80	.032	2
12	1.2	.047	3
16	1.6	.062	4
20	2.0	.078	5
24	2.4	.094	6
28	2.8	.109	7
32	3.2	.125	8
00 (inch or M0/metric)	Round insert		0

8 - Cutting edge information		
Shape	Honing	Symbol
	No honing	F
	With honing	E
	Chamfered No honing	T
	Chamfered with honing	S

9 - Angle of Chamfer	
	α
05	05°
10	10°
15	15°
20	20°
25	25°
30	30°
35	35°

10 - Width of Chamfer	
05	0,05 mm
10	0,10 mm
13	0,13 mm
15	0,15 mm
20	0,20 mm
25	0,25 mm
30	0,30 mm
35	0,35 mm
40	0,40 mm

CN - RHOMBIC 80° NEGATIVE

RÔMBICA 80° NEGATIVA | RÓMBICA 80° NEGATIVA

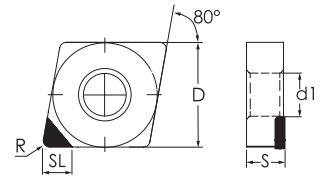

CNGA Z1 | CNGA Z2 | CNGA Z4

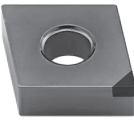
	(1) Geometry code	ISO Reference	ANSI Reference	K			H			Dimensions Dimensões Dimensiones (mm)						Cutting conditions Condições de corte Condiciones de corte					
				S4	Y5	Y4				Z	D	S	R	d1	SL	ap (mm)	Min	Max	fn (mm/r)	Min	Max
				PBH920	PBY603	PBY620															
	1124300	CNGA 120404-S2513 Z1	CNGA 431-S2513 Z1	○			1	12,70	4,76	0,40	5,16	2,50	0,15	0,08	0,50	0,08	0,05	0,20			
	1124111	CNGA 120408-S2513 Z1	CNGA 432-S2513 Z1	⊗			1	12,70	4,76	0,80	5,16	2,00	0,20	0,08	0,50	0,10	0,08	0,30			
	1124301	CNGA 120412-S2513 Z1	CNGA 433-S2513 Z1	○			1	12,70	4,76	1,20	5,16	2,30	0,25	0,08	0,50	0,12	0,08	0,30			

⊗ Stock Items | Itens de stock

○ Available under request | Disponível sob consulta | Disponible bajo consulta

Insert Order Code: (1)Geometry code + (2)Grade code

DN - RHOMBIC 55° NEGATIVE

RÔMBICA 55° NEGATIVA | RÓMBICA 55° NEGATIVA

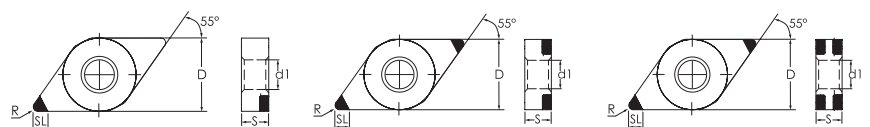

DNGA Z1 | DNGA Z2 | DNGA Z4

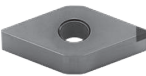
	(1) Geometry code	ISO Reference	ANSI Reference	K			H			Dimensions Dimensões Dimensiones (mm)						Cutting conditions Condições de corte Condiciones de corte					
				S4	Y5	Y4				Z	D	S	R	d1	SL	ap (mm)	Min	Max	fn (mm/r)	Min	Max
				PBH920	PBY603	PBY620															
	1124306	DNGA 150404-S2513 Z1	DNGA 431-S2513 Z1	○		○	1	12,70	4,76	0,40	5,16	2,50	0,15	0,08	0,50	0,08	0,05	0,20			
	1124112	DNGA 150408-S2513 Z1	DNGA 432-S2513 Z1	⊗		○	1	12,70	4,76	0,80	5,16	2,50	0,20	0,08	0,50	0,10	0,08	0,30			
	1124536	DNGA 150412-S2513 Z1	DNGA 433-S2513 Z1	○		○	1	12,70	4,76	1,20	5,16	2,20	0,25	0,08	0,50	0,12	0,08	0,30			

⊗ Stock Items | Itens de stock

○ Available under request | Disponível sob consulta | Disponible bajo consulta

Insert Order Code: (1)Geometry code + (2)Grade code

CN - RHOMBIC 80° NEGATIVE

RÔMBICA 80° NEGATIVA | RÓMBICA 80° NEGATIVA

CNGA Z2 | CNGA Z4

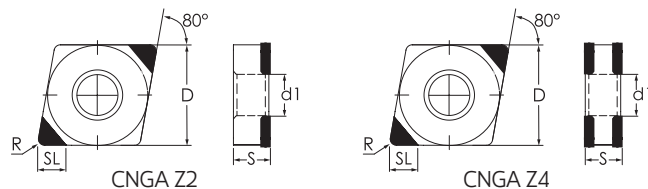

	(1) Geometry code	(2) Grade code		K			H			Dimensions Dimensões Dimensiones (mm)						Cutting conditions Condições de corte Condiciones de corte					
		ISO Reference	ANSI Reference	S4	Y5	Y4	Z	D	S	R	d1	SL	ap (mm)	Min	Max	fn (mm/r)	Min	Max			
				PBH920	PBY603	PBY620															
	1124344	CNGA 120404-S2513 Z2	CNGA 431-S2513 Z2	⊗	⊗	⊗	2	12,70	4,76	0,40	5,16	2,50	0,15	0,08	0,40	0,08	0,05	0,20			
	1124175	CNGA 120408-S2513 Z2	CNGA 432-S2513 Z2	⊗	⊗	⊗	2	12,70	4,76	0,80	5,16	2,40	0,20	0,08	0,50	0,10	0,08	0,30			
	1124568	CNGA 120408-S3515 Z2	CNGA 432-S3515 Z2			○	2	12,70	4,76	0,80	5,16	2,40	0,20	0,08	0,50	0,10	0,08	0,30			
	1124468	CNGA 120412-S2513 Z2	CNGA 433-S2513 Z2	⊗	⊗	⊗	2	12,70	4,76	1,20	5,16	2,30	0,25	0,08	0,50	0,12	0,08	0,30			
	1124569	CNGA 120412-S3515 Z2	CNGA 433-S3515 Z2			○	2	12,70	4,76	1,20	5,16	2,30	0,25	0,08	0,50	0,12	0,08	0,30			
	1124474	CNGA 120404-S2513 Z4	CNGA 431-S2513 Z4		⊗	○	4	12,70	4,76	0,40	5,16	2,50	0,15	0,08	0,40	0,08	0,05	0,20			
	1124134	CNGA 120408-S2513 Z4	CNGA 432-S2513 Z4		⊗	○	4	12,70	4,76	0,80	5,16	2,40	0,20	0,08	0,50	0,10	0,08	0,30			
	1124570	CNGA 120408-S3515 Z4	CNGA 432-S3515 Z4			○	4	12,70	4,76	0,80	5,16	2,40	0,20	0,08	0,50	0,10	0,08	0,30			
	1124475	CNGA 120412-S2513 Z4	CNGA 433-S2513 Z4		⊗	○	4	12,70	4,76	1,20	5,16	2,30	0,25	0,08	0,50	0,12	0,08	0,30			
	1124571	CNGA 120412-S3515 Z4	CNGA 433-S3515 Z4			○	4	12,70	4,76	1,20	5,16	2,30	0,25	0,08	0,50	0,12	0,08	0,30			
	1124534	CNGA 120404-S1513 WG Z4	CNGA 431-S1513 WG Z4		○	○	4	12,70	4,76	0,40	5,16	2,40	0,15	0,08	0,50	0,08	0,05	0,20			
	1124535	CNGA 120404-S2513 WG Z4	CNGA 431-S2513 WG Z4		○	○	4	12,70	4,76	0,40	5,16	2,40	0,15	0,08	0,50	0,08	0,05	0,20			
	1124517	CNGA 120408-S1513 WG Z4	CNGA 432-S1513 WG Z4		⊗	○	4	12,70	4,76	0,80	5,16	2,40	0,20	0,08	0,50	0,10	0,08	0,30			
	1124518	CNGA 120408-S2513 WG Z4	CNGA 432-S2513 WG Z4		⊗	⊗	4	12,70	4,76	0,80	5,16	2,40	0,20	0,08	0,50	0,10	0,08	0,30			

⊗ Stock items | Itens de stock

○ Available under request | Disponível sob consulta | Disponible bajo consulta

Insert Order Code: (1) Geometry code + (2) Grade code

DN - RHOMBIC 55° NEGATIVE
RÔMBICA 55° NEGATIVA | RÓMBICA 55° NEGATIVA

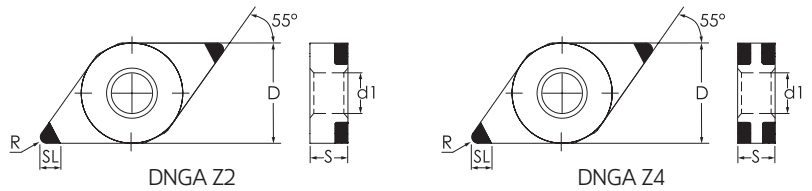

DNGA Z2 | DNGA Z4

	(1) Geometry code	(2) Grade code	ANSI Reference	K			H			Dimensions Dimensões Dimensiones (mm)						Cutting conditions Condições de corte Condiciones de corte					
				S4	Y5	Y4	Z	D	S	R	d1	SL	ap (mm)	Min	Max	fn (mm/r)	Min	Max			
				PBH920	PBY603	PBY620															
	1124616	DNGA 110404-S2513 Z2	DNGA 331-S2513 Z2		⊗		2	9,525	4,76	0,4	3,81	2,5	0,1	0,08	0,4	0,08	0,05	0,2			
	1124615	DNGA 110408-S2513 Z2	DNGA 332-S2513 Z2		⊗		2	9,525	4,76	0,8	3,81	2,0	0,15	0,08	0,4	0,1	0,08	0,3			
	1124617	DNGA 110412-S2513 Z2	DNGA 333-S2513 Z2		⊗		2	9,525	4,76	1,2	3,81	2,0	0,2	0,08	0,4	0,15	0,08	0,3			
	1124482	DNGA 150404-S2513 Z2	DNGA 431-S2513 Z2		⊗	⊗	2	12,70	4,76	0,40	5,16	2,50	0,15	0,08	0,50	0,08	0,05	0,20			
	1124483	DNGA 150408-S2513 Z2	DNGA 432-S2513 Z2		⊗	⊗	2	12,70	4,76	0,80	5,16	2,10	0,20	0,08	0,50	0,10	0,08	0,30			
	1124537	DNGA 150412-S2513 Z2	DNGA 433-S2513 Z2		○	○	2	12,70	4,76	1,20	5,16	2,20	0,25	0,08	0,50	0,12	0,08	0,30			
	1124348	DNGA 150604-S2513 Z2	DNGA 441-S2513 Z2		⊗	⊗	2	12,70	6,35	0,40	5,16	2,50	0,15	0,08	0,50	0,08	0,05	0,20			
	1124177	DNGA 150608-S2513 Z2	DNGA 442-S2513 Z2		⊗	⊗	2	12,70	6,35	0,80	5,16	2,10	0,20	0,08	0,50	0,10	0,08	0,30			
	1124572	DNGA 150608-S3515 Z2	DNGA 442-S3515 Z2			○	2	12,70	6,35	0,80	5,16	2,10	0,20	0,08	0,50	0,10	0,08	0,30			
	1124377	DNGA 150612-S2513 Z2	DNGA 443-S2513 Z2		⊗	⊗	2	12,70	6,35	1,20	5,16	2,00	0,25	0,08	0,50	0,12	0,08	0,30			
1124573	DNGA 150612-S3515 Z2	DNGA 443-S3515 Z2			○	2	12,70	6,35	1,20	5,16	2,00	0,25	0,08	0,50	0,12	0,08	0,30				
	1124479	DNGA 150604-S2513 Z4	DNGA 441-S2513 Z4		⊗		4	12,70	6,35	0,40	5,16	2,50	0,15	0,08	0,40	0,08	0,05	0,20			
	1124133	DNGA 150608-S2513 Z4	DNGA 442-S2513 Z4		⊗		4	12,70	6,35	0,80	5,16	2,10	0,20	0,08	0,50	0,10	0,08	0,30			
	1124575	DNGA 150608-S3515 Z4	DNGA 442-S3515 Z4			○	4	12,70	6,35	0,80	5,16	2,10	0,20	0,08	0,50	0,10	0,08	0,30			
	1124480	DNGA 150612-S2513 Z4	DNGA 443-S2513 Z4		⊗		4	12,70	6,35	1,20	5,16	2,00	0,25	0,08	0,50	0,12	0,08	0,30			
	1124576	DNGA 150612-S3515 Z4	DNGA 443-S3515 Z4			○	4	12,70	6,35	1,20	5,16	2,00	0,25	0,08	0,50	0,12	0,08	0,30			

⊗ Stock Items | Itens de stock

○ Available under request | Disponível sob consulta | Disponible bajo consulta

Insert Order Code: (1) Geometry code + (2) Grade code

RNGN | SOLID CBN



	(1) Geometry code	(2) Grade code		W3	W4	Dimensions Dimensões Dimensiones (mm)		Cutting conditions Condições de corte Condiciones de corte						Drawing
		ISO Reference	ANSI Reference	PB930	PB940	D	S	ap (mm)	Min	Max	fn (mm/r)	Min	Max	
	1124631	RNGN 060300-S2020 S	RNGN 220-S2020 S	○	⊗	6,35	3,18	0,15	0,08	0,5	0,12	0,08	0,3	
	1124630	RNGN 090300-S2020 S	RNGN 320-S2020 S	○	⊗	9,53	3,18	0,2	0,08	0,5	0,15	0,08	0,3	
	1124629	RNGN 120300-S2020 S	RNGN 420-S2020 S	○	⊗	12,70	3,18	0,3	0,08	0,5	0,2	0,08	0,3	
	1124699	RNGN 120400-S2020 S	RNGN 430-S2020 S	○	⊗	12,70	4,76	0,3	0,08	0,5	0,2	0,08	0,3	

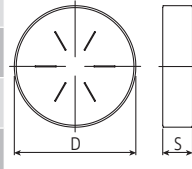

⊗ Stock item | Produto de stock | Itens de stock

○ Available under request | Disponível sobre consulta
Disponível bajo consulta

Insert order code = (1) Geometry Code + (2) Grade Code

REGROUNING INSERTS

Repair Code	(2) Grade code Reference Referência Referencia	W3	W4	Final Dimensions (mm)		Raw Material
		PB930	PB940	D	S	
3120072	RNGN 06(2.18)00-S2020S(0603)	○	○	6,35	2,18	RNGN 060300-S2020 S
3120058	RNGN 060200-S2020 S (0903)	○	○	6,35	2,38	RNGN 090300-S2020 S
3120068	RNGN 060300-S2020 S (0903)	○	○	6,35	3,18	RNGN 090300-S2020 S
3120071	RNGN 060300-S2020 S (1203)	○	○	6,35	3,18	RNGN 120300-S2020 S
3120057	RNGN 090300-S2020 S (1203)	○	○	9,53	3,18	RNGN 120300-S2020 S
3120070	RNGN 090400-S2020 S (1204)	○	○	9,53	4,76	RNGN 120400-S2020 S
3120056	RNGN 120300-S2020 S (1204)	○	○	12,70	3,18	RNGN 120400-S2020 S

⊗ Stock item | Produto de stock | Itens de stock

○ Available under request | Disponível sobre consulta
Disponível bajo consulta

Insert order code = (1) Geometry Code + (2) Grade Code

SN = SQUARE 90° NEGATIVE
QUADRADA 90° NEGATIVA | ESQUADRA 90° NEGATIVA

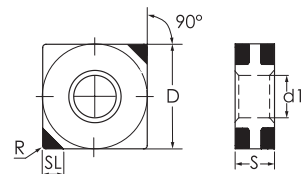

SNGA Z4

	(1) Geometry code	(2) Grade code			K	H	Dimensions Dimensões Dimensiones (mm)						Cutting conditions Condições de corte Condiciones de corte							
		ISO Reference	ANSI Reference	PB920			PB603	PB620	Z	D	S	R	d1	SL	ap (mm)	Min	Max	fn (mm/r)	Min	Max
	1124178	SNGA 120404-S2513 Z4	SNGA 431-S2513 Z4	○	⊗	4	12,70	4,76	0,40	5,16	2,40	0,15	0,08	0,40	0,08	0,05	0,20			
	1124538	SNGA 120404-T2513 Z4	SNGA 431-T2513 Z4	○	○	4	12,70	4,76	0,40	5,16	2,40	0,15	0,08	0,40	0,08	0,05	0,20			
	1124354	SNGA 120408-S2513 Z4	SNGA 432-S2513 Z4	○	⊗	4	12,70	4,76	0,80	5,16	2,00	0,20	0,08	0,50	0,10	0,08	0,30			
	1124577	SNGA 120408-S3515 Z4	SNGA 432-S3515 Z4	○	○	4	12,70	4,76	0,80	5,16	2,00	0,20	0,08	0,50	0,10	0,08	0,30			
	1124433	SNGA 120408-T2513 Z4	SNGA 432-T2513 Z4	⊗	○	4	12,70	4,76	0,80	5,16	2,00	0,20	0,08	0,50	0,10	0,08	0,30			
	1124539	SNGA 120412-S2513 Z4	SNGA 433-S2513 Z4	○	⊗	4	12,70	4,76	1,20	5,16	2,30	0,25	0,08	0,50	0,12	0,08	0,30			
	1124578	SNGA 120412-S3515 Z4	SNGA 433-S3515 Z4	○	○	4	12,70	4,76	1,20	5,16	2,30	0,25	0,08	0,50	0,12	0,08	0,30			
	1124540	SNGA 120412-T2513 Z4	SNGA 433-T2513 Z4	○	○	4	12,70	4,76	1,20	5,16	2,30	0,25	0,08	0,50	0,12	0,08	0,30			

⊗ Stock Items | Itens de stock

○ Available under request | Disponível sob consulta | Disponible bajo consulta

Insert Order Code: (1) Geometry code + (2) Grade code

TURNING
Insert selection
Overview
Negative inserts
Positive inserts
PCBN & PCD inserts
Heavy turning
External Toolholders
Internal Toolholders
Automatic Lathes
Spare Parts
Technical Data

NEGATIVE INSERTS

TN - TRIANGULAR 60° NEGATIVE

TRIANGULAR 60° NEGATIVA | TRIANGULAR 60° NEGATIVA

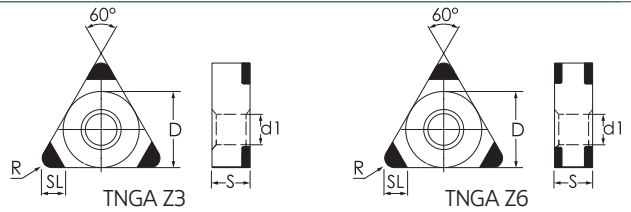

TNGA Z3 | TNGA Z6

	(1) Geometry code	(2) Grade code	ANSI Reference	K			H			Dimensions Dimensões Dimensiones (mm)						Cutting conditions Condições de corte Condiciones de corte					
				S4	Y5	Y4	Z	D	S	R	d1	SL	ap (mm)	Min	Max	fn (mm/r)	Min	Max			
				PBH920	PBY603	PBY620															
	1124357	TNGA 160404-S2513 Z3	TNGA 3431-S2513 Z3	○	⊗	⊗	3	9,53	4,76	0,40	3,81	2,30	0,15	0,08	0,50	0,08	0,05	0,20			
	1124179	TNGA 160408-S2513 Z3	TNGA 332-S2513 Z3	○	⊗	⊗	3	9,53	4,76	0,80	3,81	2,00	0,20	0,08	0,50	0,10	0,08	0,30			
	1124579	TNGA 160408-S3515 Z3	TNGA 332-S3515 Z3			○	3	9,53	4,76	0,80	3,81	2,00	0,20	0,08	0,50	0,10	0,08	0,30			
	1124469	TNGA 160412-S2513 Z3	TNGA 333-S2513 Z3	○	⊗	⊗	3	9,53	4,76	1,20	3,81	2,00	0,25	0,08	0,60	0,12	0,08	0,30			
	1124746	TNGA 160412-S3515 Z3	TNGA 333-S3515 Z3			⊗	3	9,53	4,76	1,20	3,81	2,00	0,25	0,08	0,60	0,12	0,08	0,30			
	1124603	TNGA 160416-S2513 Z3	TNGA 334-S2513 Z3		⊗	⊗	3	9,53	4,76	1,6	3,81	3,00	0,30	0,08	0,70	0,14	0,10	0,35			
	1124604	TNGA 160420-S2513 Z3	TNGA 335-S2513 Z3	⊗			3	9,53	4,73	2,0	3,81	3,00	0,35	0,10	0,55	0,16	0,10	0,40			
	1124477	TNGA 160404-S2513 Z6	TNGA 331-S2513 Z6	⊗	⊗	○	6	9,53	4,76	0,40	3,81	2,30	0,15	0,08	0,50	0,08	0,05	0,20			
	1124097	TNGA 160408-S2513 Z6	TNGA 332-S2513 Z6	⊗	⊗	○	6	9,53	4,76	0,80	3,81	2,00	0,20	0,08	0,50	0,10	0,08	0,30			
	1124581	TNGA 160408-S3515 Z6	TNGA 332-S3515 Z6			○	6	9,53	4,76	0,80	3,81	2,00	0,20	0,08	0,50	0,10	0,08	0,30			
	1124478	TNGA 160412-S2513 Z6	TNGA 333-S2513 Z6		⊗	○	6	9,53	4,76	1,20	3,81	2,00	0,25	0,08	0,60	0,12	0,08	0,30			
	1124582	TNGA 160412-S3515 Z6	TNGA 333-S3515 Z6			○	6	9,53	4,76	1,20	3,81	2,00	0,25	0,08	0,60	0,12	0,08	0,30			

⊗ Stock Items | Itens de stock

○ Available under request | Disponível sob consulta | Disponible bajo consulta

Insert Order Code: (1) Geometry code + (2) Grade code

VN - RHOMBIC 35° NEGATIVE

RÔMBICA 35° NEGATIVA | RÓMBICA 35° NEGATIVA

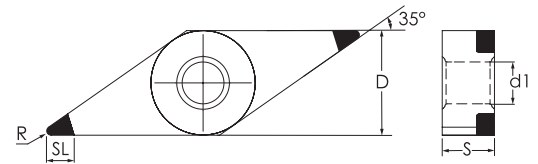

VNGA Z2

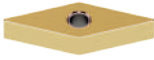
	(1) Geometry code	ISO Reference	ANSI Reference	(2) Grade code			Dimensions Dimensões Dimensiones (mm)						Cutting conditions Condições de corte Condiciones de corte					
				K	H		Z	D	S	R	d1	SL	ap (mm)	Min	Max	fn (mm/r)	Min	Max
				S4	Y5	Y4												
	1124163	VNGA 160404-S2513 Z2	VNGA 431-S2513 Z2	○	⊗	⊗	2	9,53	4,76	0,80	3,81	2,00	0,15	0,08	0,50	0,08	0,05	0,20
	1124098	VNGA 160408-S2513 Z2	VNGA 432-S2513 Z2	○	⊗	⊗	2	9,53	4,76	0,40	3,81	2,80	0,20	0,08	0,50	0,10	0,08	0,30
	1124470	VNGA 160412-S2513 Z2	VNGA 433-S2513 Z2	○	⊗	⊗	2	9,53	4,76	1,20	3,81	1,90	0,25	0,08	0,50	0,12	0,08	0,30

⊗ Stock Items | Itens de stock

○ Available under request | Disponível sob consulta | Disponible bajo consulta



Insert Order Code: (1) Geometry code + (2) Grade code

WN - TRIGON 80° NEGATIVE

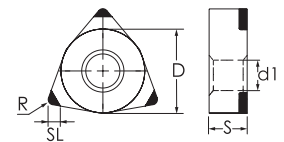
TRIGONAL 80° NEGATIVA | TRIGONA 80° NEGATIVA

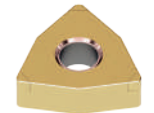

WNGA Z3 | WNGA Z6

	(1) Geometry code	ISO Reference	ANSI Reference	(2) Grade code			Dimensions Dimensões Dimensiones (mm)						Cutting conditions Condições de corte Condiciones de corte					
				K	H		Z	D	S	R	d1	SL	ap (mm)	Min	Max	fn (mm/r)	Min	Max
				S4	Y5	Y4												
	1124471	WNGA 080404-S2513 Z3	WNGA 431-S2513 Z3	○	⊗	⊗	3	12,70	4,76	0,40	5,16	2,30	0,15	0,08	0,40	0,08	0,05	0,20
	1124472	WNGA 080408-S2513 Z3	WNGA 432-S2513 Z3	○	⊗	⊗	3	12,70	4,76	0,80	5,16	2,00	0,20	0,08	0,50	0,10	0,08	0,30
	1124583	WNGA 080408-S3515 Z3	WNGA 432-S3515 Z3		○		3	12,70	4,76	0,80	5,16	2,00	0,20	0,08	0,50	0,10	0,08	0,30
	1124473	WNGA 080412-S2513 Z3	WNGA 433-S2513 Z3	○	⊗	⊗	3	12,70	4,76	1,20	5,16	2,00	0,25	0,08	0,60	0,12	0,08	0,30
	1124584	WNGA 080412-S3515 Z3	WNGA 433-S3515 Z3		○		3	12,70	4,76	1,20	5,16	2,00	0,25	0,08	0,60	0,12	0,08	0,30
	1124589	WNGA 080404-S2513 Z6	WNGA 431-S2513 Z6		○	○	6	12,70	4,76	1,20	5,16	2,00	0,25	0,08	0,40	0,12	0,08	0,30
	1124588	WNGA 080408-S2513 Z6	WNGA 432-S2513 Z6		○	○	6	12,70	4,76	0,80	5,16	2,00	0,20	0,08	0,50	0,10	0,08	0,30
	1124585	WNGA 080408-S3515 Z6	WNGA 432-S3515 Z6		○		6	12,70	4,76	0,80	5,16	2,00	0,20	0,08	0,50	0,10	0,08	0,30
	1124587	WNGA 080412-S2513 Z6	WNGA 433-S2513 Z6		○	○	6	12,70	4,76	0,40	5,16	2,30	0,15	0,08	0,60	0,08	0,05	0,20
	1124586	WNGA 080412-S3515 Z6	WNGA 433-S3515 Z6		○		6	12,70	4,76	1,20	5,16	2,00	0,25	0,08	0,60	0,12	0,08	0,30



⊗ Stock Items | Itens de stock

○ Available under request | Disponível sob consulta | Disponible bajo consulta

Insert Order Code: (1) Geometry code + (2) Grade code

POSITIVE INSERTS OVERVIEW

Vista genérica pastilhas positivas | Visión general de plaquitas positivas

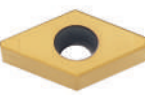
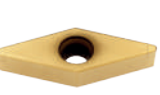
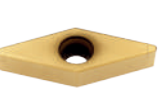
SINGLE TIP	TPGW Z1				
					
	Size 11 Page 476				
MULTIPLE TIPS	CCGW Z2	DCGW Z2	TCGW TPGW Z3	VBGW Z2	VCGW Z2
					
	Size 06 09	Size 07 11	Size 09 11	Size 11 16	Size 16
	Page 474	Page 475	Page 476	Page 477	Page 477

CC - RHOMBIC 80° POSITIVE
RÔMBICA 80° POSITIVA | RÓMBICA 80° POSITIVA

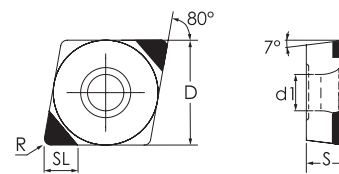

CCGW Z2

	(1) Geometry code	(2) Grade code		H		Dimensions / Dimensões / Dimensiones (mm)						Cutting conditions / Condições de corte / Condiciones de corte					
		ISO Reference	ANSI Reference	Y5	Y4	Z	D	S	R	d1	SL	ap (mm)	Min	Max	fn (mm/r)	Min	Max
				PBY603	PBY620												
	1124605	CCGW 060202-S1513 Z2	CCGW 21.50.5-S1513 Z2	⊗	⊗	2	6,35	2,38	0,2	2,8	2,0	0,15	0,05	0,20	0,08	0,05	0,20
	1124635	CCGW 060202-S2513 Z2	CCGW 21.50.5-S2513 Z2	⊗	⊗	2	6,35	2,38	0,2	2,8	2,4	0,15	0,05	0,20	0,08	0,05	0,20
	1124606	CCGW 060204-S1513 Z2	CCGW 21.51-S1513 Z2	⊗	⊗	2	6,35	2,38	0,4	2,8	2,0	0,15	0,05	0,40	0,08	0,05	0,25
	1124555	CCGW 060204-S2513 Z2	CCGW 21.51-S2513 Z2	⊗	⊗	2	6,35	2,38	0,4	2,8	2,0	0,15	0,05	0,40	0,08	0,05	0,25
	1124607	CCGW 060208-S1513 Z2	CCGW 21.52-S1513 Z2	⊗	⊗	2	6,35	2,38	0,8	2,8	2,0	0,2	0,08	0,50	0,10	0,08	0,30
	1124636	CCGW 060208-S2513 Z2	CCGW 21.52-S2513 Z2	⊗	⊗	2	6,35	2,38	0,8	2,8	2,4	0,2	0,08	0,50	0,10	0,08	0,30
	1124638	CCGW 09T302-S2513 Z2	CCGW 32.50.5-S2513 Z2	⊗	⊗	2	9,53	3,97	0,2	4,4	2,5	0,15	0,05	0,20	0,08	0,05	0,20
	1124640	CCGW 09T304-S2513 Z2	CCGW 32.51-S2513 Z2	⊗	⊗	2	9,53	3,97	0,4	4,4	2,5	0,20	0,08	0,40	0,10	0,05	0,25
	1124632	CCGW 09T308-S2513 Z2	CCGW 32.52-S2513 Z2	○	○	2	9,53	3,97	0,8	4,4	2,5	0,20	0,08	0,50	0,10	0,08	0,30
	1124637	CCGW 09T302-S2513 WG Z2	CCGW 32.50.5-S2513 WG Z2	⊗	○	2	9,53	3,97	0,2	4,4	2,4	0,15	0,05	0,20	0,08	0,05	0,20
	1124639	CCGW 09T304-S2513 WG Z2	CCGW 32.51-S2513 WG Z2	○	⊗	2	9,53	3,97	0,4	4,4	2,4	0,20	0,08	0,40	0,10	0,05	0,25
	1124641	CCGW 09T308-S2513 WG Z2	CCGW 32.52-S2513 WG Z2	⊗	⊗	2	9,53	3,97	0,8	4,4	2,4	0,20	0,08	0,50	0,10	0,08	0,30
	1124608	CCGW 09T302-S1513 Z2	CCGW 32.50.5-S1513 Z2	⊗	⊗	2	9,53	3,97	0,2	4,4	2,0	0,15	0,05	0,20	0,08	0,05	0,20
	1124609	CCGW 09T304-S1513 Z2	CCGW 32.51-S1513 Z2	⊗	⊗	2	9,53	3,97	0,4	4,4	2,0	0,20	0,08	0,40	0,10	0,05	0,25
	1124610	CCGW 09T308-S1513 Z2	CCGW 32.52-S1513 Z2	⊗	⊗	2	9,53	3,97	0,8	4,4	2,0	0,20	0,08	0,50	0,10	0,08	0,30

⊗ Stock Items | Itens de stock

○ Available under request | Disponível sob consulta | Disponible bajo consulta

Insert Order Code: (1) Geometry code + (2) Grade code

DC = RHOMBIC 55° POSITIVE

RÔMBICA 55° POSITIVA | RÓMBICA 55° POSITIVA

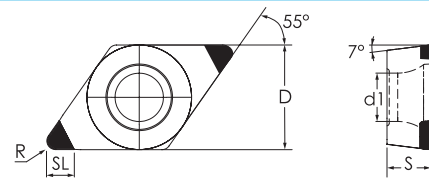

DCGW Z2

	(1) Geometry code	(2) Grade code		H		Dimensions Dimensões Dimensiones (mm)						Cutting conditions Condições de corte Condiciones de corte					
		ISO Reference	ANSI Reference	Y5	Y4	Z	D	S	R	d1	SL	ap (mm)	Min	Max	fn (mm/r)	Min	Max
				PBY603	PBY620												
	1124642	DCGW 070202-S1513 Z2	DCGW 21.50.5-S1513 Z2	⊗	○	2	6,35	2,38	0,2	2,8	2,5	0,15	0,08	0,20	0,08	0,05	0,20
	1124611	DCGW 070202-S2513 Z2	DCGW 21.50.5-S2513 Z2	⊗	⊗	2	6,35	2,38	0,2	2,8	2,0	0,15	0,08	0,20	0,08	0,05	0,20
	1124643	DCGW 070204-S1513 Z2	DCGW 21.51-S1513 Z2	⊗	○	2	6,35	2,38	0,4	2,8	2,5	0,15	0,08	0,40	0,08	0,05	0,25
	1124436	DCGW 070204-S2513 Z2	DCGW 21.51-S2513 Z2	⊗	⊗	2	6,35	2,38	0,4	2,8	2,4	0,15	0,08	0,40	0,08	0,05	0,25
	1124644	DCGW 070208-S1513 Z2	DCGW 21.52-S1513 Z2	○	○	2	6,35	2,38	0,8	2,8	2,0	0,2	0,08	0,50	0,10	0,08	0,30
	1124612	DCGW 070208-S2513 Z2	DCGW 21.52-S2513 Z2	⊗	⊗	2	6,35	2,38	0,8	2,8	2,5	0,2	0,08	0,50	0,10	0,08	0,30
	1124613	DCGW 11T302-S2513 Z2	DCGW 32.50.5-S2513 Z2	⊗	⊗	2	9,53	3,97	0,2	4,4	2,7	0,15	0,08	0,20	0,08	0,05	0,20
	1124554	DCGW 11T304-S2513 Z2	DCGW 32.51-S2513 Z2	⊗	⊗	2	9,53	3,97	0,4	4,4	2,5	0,2	0,08	0,40	0,10	0,05	0,25
	1124744	DCGW 11T304-S3515 Z2	DCGW 32.51-S3515 Z2	○	⊗	2	9,53	3,97	0,4	4,4	2,5	0,2	0,08	0,40	0,10	0,05	0,25
	1124614	DCGW 11T308-S2513 Z2	DCGW 32.52-S2513 Z2	⊗	⊗	2	9,53	3,97	0,8	4,4	2,0	0,2	0,08	0,50	0,10	0,08	0,30
	1124745	DCGW 11T308-S3515 Z2	DCGW 32.52-S3515 Z2	○	⊗	2	9,53	3,97	0,8	4,4	2,0	0,2	0,08	0,50	0,10	0,08	0,30
	1124645	DCGW 11T302-S1513 Z2	DCGW 32.50.5-S1513 Z2	⊗	○	2	9,53	3,97	0,2	4,4	2,7	0,15	0,08	0,20	0,08	0,05	0,20
	1124647	DCGW 11T304-S1513 Z2	DCGW 32.51-S1513 Z2	⊗	○	2	9,53	3,97	0,4	4,4	2,5	0,2	0,08	0,40	0,10	0,05	0,25
	1124649	DCGW 11T308-S1513 Z2	DCGW 32.52-S1513 Z2	○	○	2	9,53	3,97	0,8	4,4	2,0	0,2	0,08	0,50	0,10	0,08	0,30

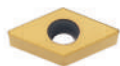

⊗ Stock Items | Itens de stock

○ Available under request | Disponível sob consulta | Disponible bajo consulta

Insert Order Code: (1) Geometry code + (2) Grade code

TC - TRIANGULAR 60° POSITIVE

TRIANGULAR 60° POSITIVA | TRIANGULAR 60° POSITIVA

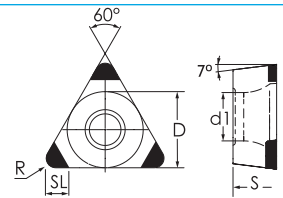

TCGW Z3

	(1) Geometry code	(2) Grade code		H		Dimensions Dimensões Dimensiones (mm)						Cutting conditions Condições de corte Condiciones de corte					
		ISO Reference	ANSI Reference	PB603	PB620	Z	D	S	R	d1	SL	ap (mm)	Min	Max	fn (mm/r)	Min	Max
	1124434	TCGW 16T304-S2513 Z3	TCGW 32.51-S2513 Z3	⊗	⊗	3	9,53	3,97	0,4	4,4	2,5	0,15	0,08	0,45	0,08	0,05	0,20
	1124651	TCGW 16T308-S2513 Z3	TCGW 32.52-S2513 Z3	⊗	⊗	3	9,53	3,97	0,8	4,4	2,0	0,2	0,08	0,45	0,10	0,08	0,30

⊗ Stock Items | Itens de stock

○ Available under request | Disponível sob consulta | Disponible bajo consulta



Insert Order Code: (1)Geometry code + (2)Grade code

TP - TRIANGULAR 60° POSITIVE

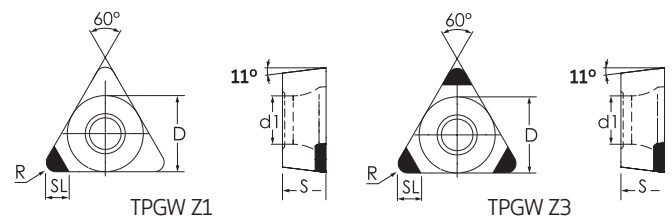
TRIANGULAR 60° POSITIVA | TRIANGULAR 60° POSITIVA



TPGW Z1 / TPGW Z3

	(1) Geometry code	(2) Grade code		H		Dimensions Dimensões Dimensiones (mm)						Cutting conditions Condições de corte Condiciones de corte					
		ISO Reference	ANSI Reference	PB603	PB620	Z	D	S	R	d1	SL	ap (mm)	Min	Max	fn (mm/r)	Min	Max
	1124657	TPGW 110302-S2513 Z1	TPGW 220.5-S2513 Z1	○	○	1	6,35	2,38	0,2	2,8	2,4	0,15	0,08	0,20	0,08	0,05	0,15
	1124660	TPGW 110304-S2513 Z1	TPGW 221-S2513 Z1	⊗	○	1	6,35	2,38	0,4	2,8	2,3	0,15	0,08	0,40	0,08	0,05	0,20
	1124598	TPGW 110308-S2513 Z1	TPGW 222-S2513 Z1	⊗	⊗	1	6,35	2,38	0,8	2,8	2,4	0,20	0,08	0,45	0,10	0,08	0,20
	1124652	TPGW 090202-S1513 Z3	TPGW 1.81.50.5-S1513 Z3	⊗	○	3	5,56	2,38	0,2	2,5	2,5	0,10	0,08	0,20	0,08	0,05	0,15
	1124653	TPGW 090202-S2513 Z3	TPGW 1.81.50.5-S2513 Z3	⊗	○	3	5,56	2,38	0,2	2,5	2,5	0,10	0,05	0,20	0,08	0,05	0,15
	1124654	TPGW 090204-S1513 Z3	TPGW 1.81.51-S1513 Z3	⊗	○	3	5,56	2,38	0,4	2,5	2,3	0,15	0,08	0,40	0,08	0,05	0,15
	1124655	TPGW 090204-S2513 Z3	TPGW 1.81.51-S2513 Z3	⊗	⊗	3	5,56	2,38	0,4	2,5	2,3	0,15	0,08	0,40	0,08	0,05	0,15
	1124658	TPGW 110302-S2513 Z3	TPGW 220.5-S2513 Z3	⊗	⊗	3	6,35	2,38	0,2	2,8	2,4	0,15	0,08	0,20	0,08	0,05	0,15
	1124661	TPGW 110304-S2513 Z3	TPGW 221-S2513 Z3	⊗	⊗	3	6,35	2,38	0,4	2,8	2,3	0,15	0,08	0,40	0,08	0,05	0,20
	1124663	TPGW 110308-S2513 Z3	TPGW 222-S2513 Z3	○	⊗	3	6,35	2,38	0,8	2,8	2	0,20	0,08	0,50	0,10	0,08	0,20
	1124656	TPGW 110302-S1513 Z3	TPGW 220.5-S1513 Z3	⊗	○	3	6,35	2,38	0,2	2,8	2,4	0,15	0,08	0,20	0,08	0,05	0,15
	1124659	TPGW 110304-S1513 Z3	TPGW 221-S1513 Z3	⊗	○	3	6,35	2,38	0,4	2,8	2,3	0,15	0,08	0,40	0,08	0,05	0,20
	1124662	TPGW 110308-S1513 Z3	TPGW 222-S1513 Z3	○	○	3	6,35	2,38	0,8	2,8	2	0,20	0,08	0,50	0,10	0,08	0,20

⊗ Stock Items | Itens de stock

○ Available under request | Disponível sob consulta | Disponible bajo consulta

Insert Order Code: (1)Geometry code + (2)Grade code

VB = RHOMBIC 35° POSITIVE

RÔMBICA 35° POSITIVA | RÓMBICA 35° POSITIVA

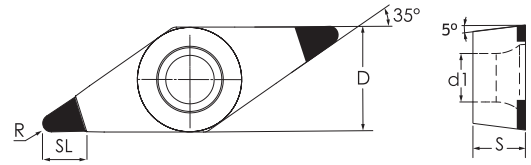

VBGW Z2

	(1) Geometry code	(2) Grade code		H		Dimensions Dimensões Dimensiones (mm)						Cutting conditions Condições de corte Condiciones de corte					
		ISO Reference	ANSI Reference	Y5	Y4	Z	D	S	R	d1	SL	ap (mm)	Min	Max	fn (mm/r)	Min	Max
				PBY603	PBY620												
	1124664	VBGW 110302-S2513 Z2	VBGW 220.5-S2513 Z2	⊗	⊗	2	6,35	3,18	0,2	2,8	3,2	0,10	0,08	0,20	0,05	0,05	0,15
	1124665	VBGW 110304-S2513 Z2	VBGW 221-S2513 Z2	⊗	⊗	2	6,35	3,18	0,4	2,8	2,8	0,15	0,08	0,40	0,08	0,05	0,20
	1124666	VBGW 110308-S2513 Z2	VBGW 222-S2513 Z2	○	⊗	2	6,35	3,18	0,8	2,8	2,0	0,15	0,08	0,50	0,10	0,08	0,25
	1124618	VBGW 160402-S2513 Z2	VBGW 330.5-S2513 Z2	⊗	⊗	2	9,53	4,76	0,2	4,4	2,0	0,10	0,08	0,20	0,08	0,05	0,15
	1124619	VBGW 160404-S2513 Z2	VBGW 331-S2513 Z2	⊗	⊗	2	9,53	4,76	0,4	4,4	2,0	0,15	0,08	0,40	0,08	0,05	0,20
	1124620	VBGW 160408-S2513 Z2	VBGW 332-S2513 Z2	⊗	⊗	2	9,53	4,76	0,8	4,4	2,0	0,20	0,08	0,50	0,10	0,08	0,30
	1124621	VBGW 160402-S1513 Z2	VBGW 330.5-S1513 Z2	⊗	⊗	2	9,53	4,76	0,2	4,4	2,0	0,10	0,08	0,20	0,08	0,05	0,15
	1124622	VBGW 160404-S1513 Z2	VBGW 331-S1513 Z2	⊗	⊗	2	9,53	4,76	0,4	4,4	2,0	0,15	0,08	0,40	0,08	0,05	0,20
	1124623	VBGW 160408-S1513 Z2	VBGW 332-S1513 Z2	⊗	⊗	2	9,53	4,76	0,8	4,4	2,0	0,20	0,08	0,50	0,10	0,08	0,30

⊗ Stock Items | Itens de stock

○ Available under request | Disponível sob consulta | Disponible bajo consulta

Insert Order Code: (1) Geometry code + (2) Grade code

VC = RHOMBIC 35° POSITIVE

RÔMBICA 35° POSITIVA | RÓMBICA 35° POSITIVA

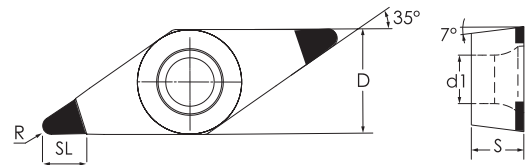

VCGW Z2

	(1) Geometry code	(2) Grade code		H		Dimensions Dimensões Dimensiones (mm)						Cutting conditions Condições de corte Condiciones de corte					
		ISO Reference	ANSI Reference	Y5	Y4	Z	D	S	R	d1	SL	ap (mm)	Min	Max	fn (mm/r)	Min	Max
				PBY603	PBY620												
	1124667	VCGW 160404-S2513 Z2	VCGW 331-S2513 Z2	⊗	⊗	2	9,53	4,76	0,4	4,4	2,8	0,15	0,08	0,40	0,08	0,05	0,20
	1124668	VCGW 160408-S2513 Z2	VCGW 332-S2513 Z2	⊗	⊗	2	9,53	4,76	0,8	4,4	2,0	0,20	0,08	0,50	0,10	0,08	0,30

⊗ Stock Items | Itens de stock

○ Available under request | Disponível sob consulta | Disponible bajo consulta

Insert Order Code: (1) Geometry code + (2) Grade code

PCD GRADES SELECTION

Seleção de graus | Selección de calidades

PCD (Polycrystalline Diamond) is a composite of diamond particles that are sintered with a metallic binder creating the hardest and one of the most abrasion resistant materials used in cutting tools.

Its development achieved an extremely significance for the machining of Non-Ferrous Materials, such as high-silicon aluminium, metal matrix composites (MMC) and carbon fibre reinforced plastics (CFRP).

Grade description:

Grade	Code	Characteristics	Application
PDP410	D6	General purpose Fine surface finishing	<ul style="list-style-type: none"> - <14% silicon aluminium alloy - automotive industry - Graphite and graphite composites - Wood composites - Copper alloy
PDP403	I3	Highest abrasion resistance Bimodal grain structure for increased diamond percentage content	<ul style="list-style-type: none"> - >14% silicon aluminium alloy - Fiber glass, fiberboard - Wood laminates - Metal matrix composites - Stone sawing - Ceramics - Sintered tungsten carbide (10-16% Co)

PDP410

<14% silicon
aluminium
alloy

PDP403

>14% silicon
aluminium
alloy

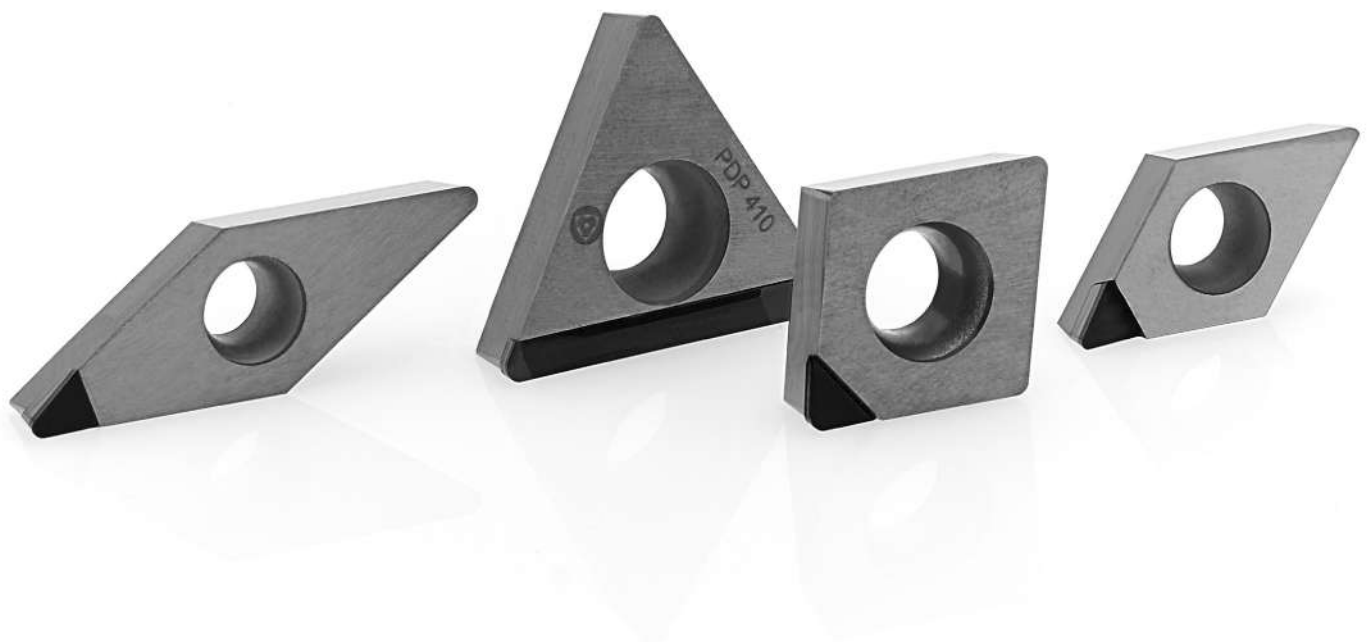

DIATURN
PCD
RANGE



GEOMETRY SELECTION

Seleção da geometria | Selección de la geometria

The insert geometry and nose radius are very important on turning operation having direct influence on the tool life and productivity.

Insert nose radius is an important performance parameter:

- For good chip breaking, must be used a small nose radius: 0,2-0,4mm (0,008-0,016inch);
- A large nose radius: 0,8-1,2mm (0,031-0,047inch) generates better surface finishing and produces thinner chips, which reduces the degree of crater wear in hard part turning operations
- The machining with large nose radius and small depth of cut results in reduced entry and exit forces..

In general, a large nose radius provides greater edge strength and therefore extended tool life. For this reason, it is advised to use the largest and allowed nose radius based on the requirements of each process.

Finishing and semi-finishing:

In these cases, there are special requirements on the surface and tolerances.

Roughing:

For the evaluation of the cutting edge radius in roughing operations it is recommended to use the following formula, in order to calculate the minimum radius vs feed:

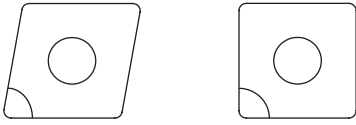
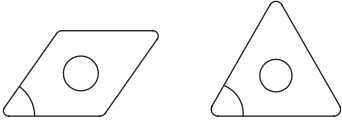
Insert shape	Formula
	$\text{Radius} > 1,6 \times \text{feed per rev.}$
	$\text{Radius} > 2,5 \times \text{feed per rev.}$

Seleção da preparação de aresta | Selección de la preparación de arista

The most important criteria for the stability and cutting edge tool-life is to define the correct cutting edge preparation. Its choice is mainly required in order to achieve the best economical result.

Edge preparation:

PCD: F type cutting edge preparation:

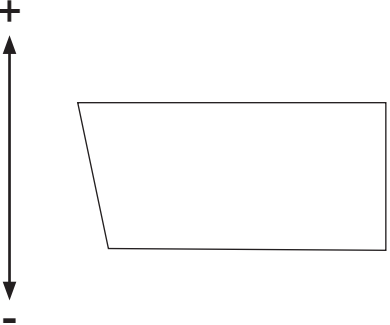
<p>Cutting forces Edge strength</p> 	<p>F – Standard preparation without honing - Standard</p> <ul style="list-style-type: none"> - Sharp cutting edge; - Standard and recommended edge preparation for aluminium or other non-ferrous materials.
---	---

Note:

Based on our experience sometimes is necessary to define edge preparation during several tests to provide the best possible solution for each application.

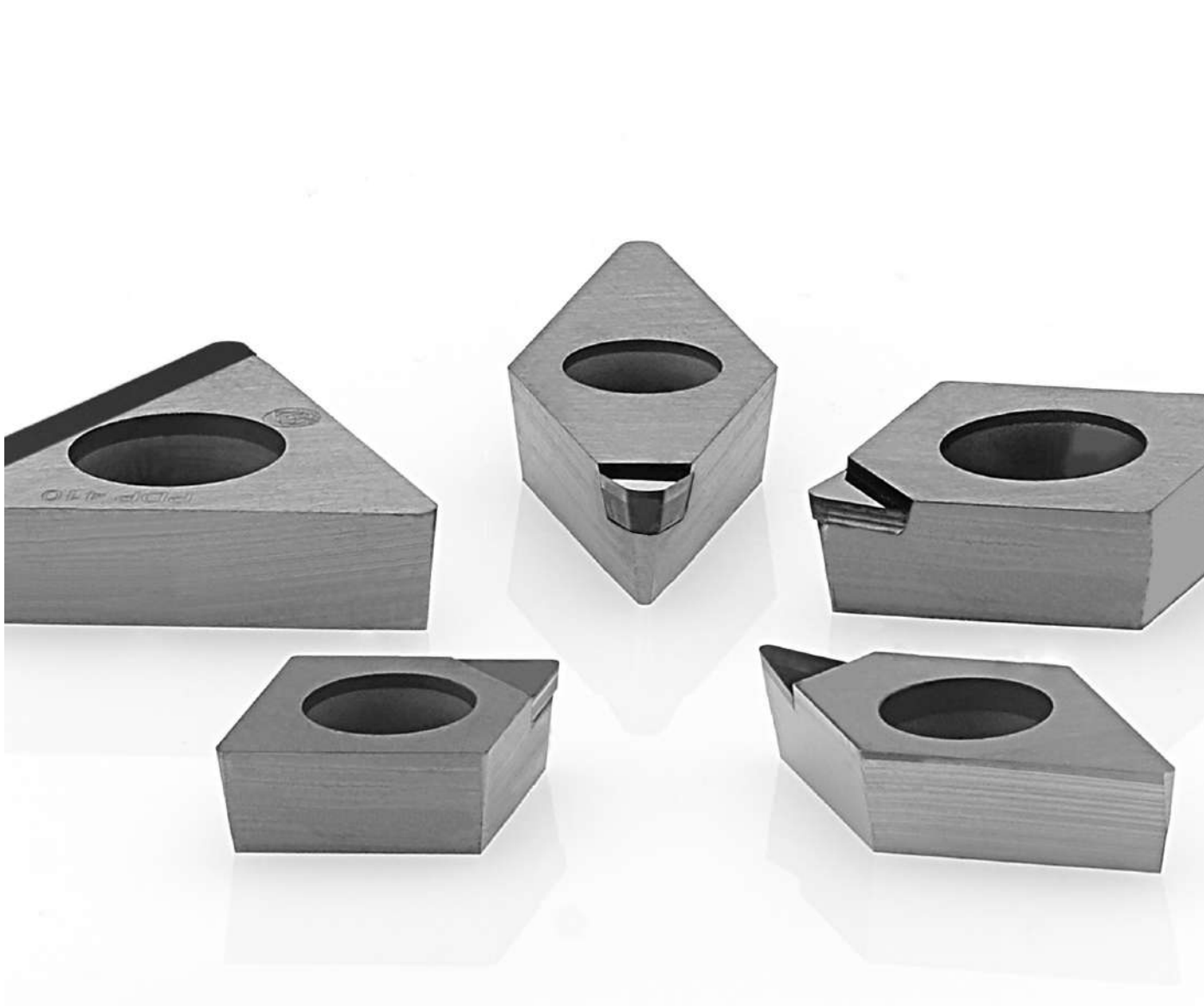

ISO PCD INSERTS CODE KEY

H		M	
O		V	
P		W	
S		L	
T		A	
C		B	
D		K	
E		R	
F		X	Special

1- Insert shape symbol

Symbol	m (mm)	d (mm)	s (mm)
A	±0.005	±0.025	±0.025
F	±0.005	±0.013	±0.025
C	±0.013	±0.025	±0.025
H	±0.013	±0.013	±0.025
E	±0.025	±0.025	±0.025
G	±0.025	±0.025	±0.13
J	±0.005	±0.05~±0.13	±0.025
K*	±0.013	±0.05~±0.13	±0.025
L*	±0.025	±0.05~±0.13	±0.025
M*	±0.08~±0.20	±0.05~±0.13	±0.13
N*	±0.08~±0.20	±0.05~±0.13	±0.025
U*	±0.13~±0.38	±0.08~±0.25	±0.13

As a rule, the sides of these inserts are as sintered. Tolerance differs with insert size, for the accuracy of class M, refer to the table on the right.

Triangular inserts with a facet (secondary cutting edge)

Detailed dimension of M class insert Insert height Tolerances (mm)					
Inscribed circle	T	S	C	D	V
6.35	±0.08	-	-	-	-
9.525	±0.08	±0.08	±0.11	±0.10	±0.13
12.70	±0.13	±0.13	±0.13	±0.15	-
15.875	±0.15	±0.15	±0.15	±0.18	-
19.05	±0.15	±0.15	±0.15	±0.18	-
25.40	-	±0.18	-	-	-
31.75	-	±0.25	-	-	-

Inscribed circle Tolerances (mm)					
Inscribed circle	T	S	C	D	V
6.35	±0.05	-	-	-	-
9.525	±0.05	±0.05	±0.05	±0.05	±0.05
12.70	±0.08	±0.08	±0.08	±0.08	±0.08
15.875	±0.10	±0.10	±0.10	±0.10	±0.10
19.05	-	-	-	-	±0.10
25.40	-	±0.13	-	-	±0.10
31.75	-	±0.20	-	-	±0.12

3 - Tolerances symbol

A	B	C	D	E
F	G	N	P	O
				Other clearance angle

2 - Normal clearance symbol

ISO	D	C	G	W
ANSI	D	C	G	W

4 - Insert symbol									
symbol	Type	Hole type	Chipbreaker	Shape	symbol	Type	Hole type	Chipbreaker	Shape
W	with hole	Round hole one countersink (40°-60°)	Without chipbreaker		G	with hole	Round hole	Chipbreaker on both sides	
T			Chipbreaker on one side		N	without hole	-	Without chipbreaker	
A	with hole	Round hole	Without chipbreaker		R	without hole	-	Chipbreaker on one side	
M			Chipbreaker on one side		X		-	-	-

R's	35° V's	55° D's	80° C's	90° S's	60° T's	80° W's	IC		ANSI
							mm	inch	Symbol
-	06	04	-	03	06	02	3,97	5/32	1,20
-	08	05	04	04	08	L3	4,76	3/16	1,50
-	09	06	05	05	09	03	5,56	7/32	1,80
06**	-	-	-	-	-	-	6,00	0,236	
06*	11	07	06	06	11	04	6,35	1/4	2,00
07*	13	09	08	07	13	05	7,94	5/16	2,50
08*	-	-	-	-	-	-	8,00	0,315	
09*	16	11	09	09	16	06	9,525	3/8	3,00
10**	-	-	-	-	-	-	10,00	0,394	
12**	-	-	-	-	-	-	12,00	0,472	
12*	22	15	12	12	22	08	12,70	1/2	4,00
15*	27	19	16	15	27	10	15,875	5/8	5,00
16**	-	-	-	-	-	-	16,00	0,63	
19*	33	23	19	19	33	13	19,05	3/4	6,00
20**	-	-	-	-	-	-	20,00	0,787	
25**	-	-	-	-	-	-	25,00	0,984	
25*	44	31	25	25	44	17	25,40	1,00	8,00
31*	54	38	32	31	54	21	31,75	1 1/4	10,00
32**	-	-	-	-	-	-	32,00	1,26	

* ANSI designation only
(Radius Designation is R0)

** Metric designation only
(Radius Designation is M0)

According to International Standard ISO 1832 - 2012(E)

"Indexable inserts for cutting tools - Designation"

ISO	mm	ANSI	inch
01	1.59	1	0.062
T1	1.98	1.2	0.078
02	2.38	1.5	0.094
03	3.18	2	0.125
T3	3.97	2.5	0.156
04	4.76	3	0.188
05	5.56	3.5	0.219
06	6.35	4	0.250
07	7.94	5	0.312
09	9.52	6	0.375
12	12.70	8	0.500

5 - Insert size symbol

6 - Insert thickness symbol

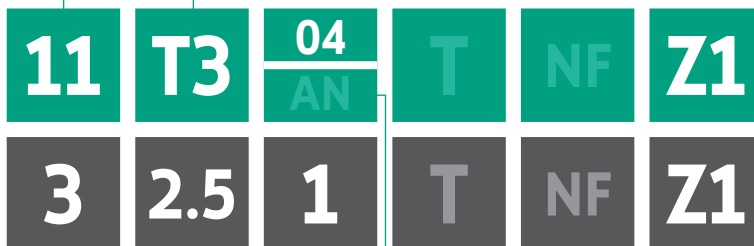

10 - Tip type	
Z1 (1 tip)	Z6 (6 tips)
Z2 (2 tips)	Z8 (8 tips)
Z3 (3 tips)	FL (Full edge left)
Z4 (4 tips)	FR (Full edge right)
Z5 (5 tips)	O (other)

7 - Insert corner symbol			
ISO	mm	inch	ANSI
00	Sharp nose		0
01	0.10	.004	0.2
02	0.20	.008	0.5
04	0.40	.015	1
08	0.80	.032	2
12	1.2	.047	3
16	1.6	.062	4
20	2.0	.078	5
24	2.4	.094	6
28	2.8	.109	7
32	3.2	.125	8
⁰⁰ (inch or M0/ metric)	Round insert		0

7.1* - Insert edges symbol			
For inserts having secondary edges two digits are used:			
1 st digit is secondary edge		2 nd digit is secondary edges relief angle	
A	45°	A	3°
D	60°	B	5°
E	75°	C	7°
F	85°	D	15°
P	90°	E	20°
Z	special	F	25°
		G	30°
		N	0°
		P	11°
		Z	special

*only when required.

8* - Cutting edge information		
Shape	Honing	Symbol
	No honing	F
	With honing	E
	Chamfered No honing	T
	Chamfered with honing	S

*only when required.

9 - Chipbreaker geometries	
NF	Finishing

NEGATIVE INSERTS

CN - RHOMBIC 80° NEGATIVE

RÔMBICA 80° NEGATIVA | RÓMBICA 80° NEGATIVA

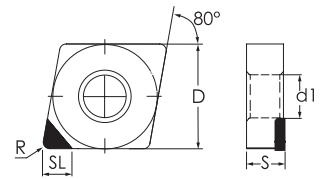

CNGA Z1

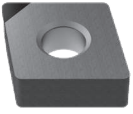
	(1) Geometry code	(2) Grade code		N		Dimensions Dimensões Dimensiones (mm)						Cutting conditions Condições de corte Condiciones de corte					
		ISO Reference	ANSI Reference	PDP410	PDP403	D	S	R	d1	W	SL	ap (mm)	Min	Max	fn (mm/r)	Min	Max
	1124228	CNGA 120404 Z1	CNGA 431 Z1	<input checked="" type="radio"/>	<input checked="" type="radio"/>	12,70	4,76	0,40	5,16	-	3,50	0,10	0,07	0,40	0,10	0,06	0,20
	1124110	CNGA 120408 Z1	CNGA 432 Z1	<input checked="" type="radio"/>	<input checked="" type="radio"/>	12,70	4,76	0,80	5,16	-	3,50	0,15	0,07	0,80	0,15	0,08	0,30
	1124229	CNGA 120412 Z1	CNGA 433 Z1	<input checked="" type="radio"/>	<input checked="" type="radio"/>	12,70	4,76	1,20	5,16	-	3,50	0,25	0,08	1,20	0,30	0,10	0,40
	1124230	CNGA 120416 Z1	CNGA 434 Z1	<input checked="" type="radio"/>	<input checked="" type="radio"/>	12,70	4,76	1,60	5,16	-	3,50	0,50	0,08	1,60	0,35	0,10	0,50

Stock Items | Itens de stock

Available under request | Disponível sob consulta | Disponible bajo consulta

Insert Order Code: (1) Geometry code + (2) Grade code

DN - RHOMBIC 55° NEGATIVE

RÔMBICA 55° NEGATIVA | RÓMBICA 55° NEGATIVA

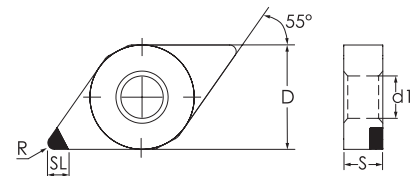

DNGA Z1

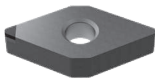
	(1) Geometry code	(2) Grade code		N		Dimensions Dimensões Dimensiones (mm)						Cutting conditions Condições de corte Condiciones de corte					
		ISO Reference	ANSI Reference	PDP410	PDP403	D	S	R	d1	W	SL	ap (mm)	Min	Max	fn (mm/r)	Min	Max
	1124235	DNGA 150404 Z1	DNGA 431 Z1	<input checked="" type="radio"/>	<input checked="" type="radio"/>	12,70	4,76	0,40	5,16	-	3,50	0,10	0,07	0,40	0,10	0,05	0,20
	1124236	DNGA 150408 Z1	DNGA 432 Z1	<input checked="" type="radio"/>	<input checked="" type="radio"/>	12,70	4,76	0,80	5,16	-	3,50	0,15	0,07	0,80	0,15	0,05	0,25
	1124362	DNGA 150608 Z1	DNGA 442 Z1	<input checked="" type="radio"/>	<input checked="" type="radio"/>	12,70	6,35	0,80	5,16	-	3,50	0,15	0,07	0,80	0,15	0,05	0,25
	1124363	DNGA 150612 Z1	DNGA 443 Z1	<input checked="" type="radio"/>	<input checked="" type="radio"/>	12,70	6,35	1,20	5,16	-	3,50	0,20	0,08	1,20	0,20	0,05	0,30

Stock Items | Itens de stock

Available under request | Disponível sob consulta | Disponible bajo consulta

Insert Order Code: (1) Geometry code + (2) Grade code

SN - SQUARE 90° NEGATIVE

QUADRADA 90° NEGATIVA | ESQUADRA 90° NEGATIVA

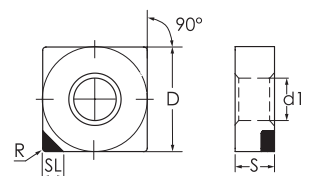

SNGA Z1

	(1) Geometry code	(2) Grade code		N		Dimensions Dimensões Dimensiones (mm)						Cutting conditions Condições de corte Condiciones de corte					
		ISO Reference	ANSI Reference	PDP410	PDP403	D	S	R	d1	W	SL	ap (mm)	Min	Max	fn (mm/r)	Min	Max
	1124243	SNGA 090304 Z1	SNGA 321 Z1	<input checked="" type="radio"/>	<input checked="" type="radio"/>	9,53	3,18	0,40	3,81	-	3,50	0,10	0,07	0,40	0,10	0,07	0,20
	1124244	SNGA 090308 Z1	SNGA 322 Z1	<input checked="" type="radio"/>	<input checked="" type="radio"/>	9,53	3,18	0,80	3,81	-	3,50	0,20	0,08	0,80	0,12	0,08	0,25
	1124245	SNGA 120404 Z1	SNGA 431 Z1	<input checked="" type="radio"/>	<input checked="" type="radio"/>	12,70	4,76	0,40	5,16	-	3,50	0,10	0,07	0,40	0,12	0,07	0,25
	1124246	SNGA 120408 Z1	SNGA 432 Z1	<input checked="" type="radio"/>	<input checked="" type="radio"/>	12,70	4,76	0,80	5,16	-	3,50	0,20	0,08	0,80	0,15	0,08	0,30

Stock Items | Itens de stock

Available under request | Disponível sob consulta | Disponible bajo consulta

Insert Order Code: (1) Geometry code + (2) Grade code

TN - TRIANGULAR 60° NEGATIVE

TRIANGULAR 60° NEGATIVA | TRIANGULAR 60° NEGATIVA

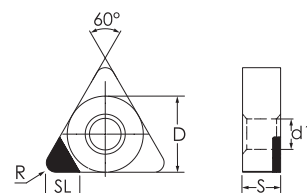

TNGA Z1

	⁽¹⁾ Geometry code	⁽²⁾ Grade code		N		Dimensions Dimensões Dimensiones (mm)						Cutting conditions Condições de corte Condiciones de corte					
		ISO Reference	ANSI Reference	D6	I3	D	S	R	d1	W	SL	ap (mm)	Min	Max	fn (mm/r)	Min	Max
				PDP410	PDP403												
	1124256	TNGA 110304 Z1	TNGA 221 Z1	○	○	6,350	3,18	0,40	2,26	-	3,50	0,10	0,08	0,40	0,08	0,03	0,15
	1124257	TNGA 110308 Z1	TNGA 222 Z1	○	○	6,350	3,18	0,80	2,26	-	3,50	0,15	0,10	0,80	0,10	0,05	0,25
	1124258	TNGA 160404 Z1	TNGA 331 Z1	○	○	9,525	4,76	0,40	3,81	-	3,50	0,10	0,08	0,40	0,10	0,05	0,20
	1124259	TNGA 160408 Z1	TNGA 332 Z1	○	○	9,525	4,76	0,80	3,81	-	3,50	0,20	0,10	0,80	0,15	0,08	0,30
	1124385	TNGA 160412 Z1	TNGA 333 Z1	○	○	9,525	4,76	1,20	3,81	-	3,50	0,20	0,10	0,80	0,15	0,08	0,30

Stock Items | Itens de stock

○ Available under request | Disponível sob consulta | Disponible bajo consulta

Insert Order Code: ⁽¹⁾Geometry code + ⁽²⁾Grade code

VN - RHOMBIC 35° NEGATIVE

RÔMBICA 35° NEGATIVA | RÓMBICA 35° NEGATIVA

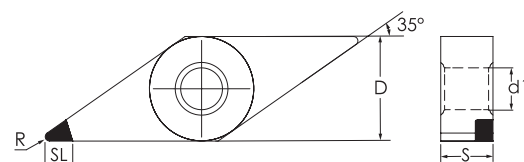

VNGA Z1

	⁽¹⁾ Geometry code	⁽²⁾ Grade code		N		Dimensions Dimensões Dimensiones (mm)						Cutting conditions Condições de corte Condiciones de corte					
		ISO Reference	ANSI Reference	D6	I3	D	S	R	d1	W	SL	ap (mm)	Min	Max	fn (mm/r)	Min	Max
				PDP410	PDP403												
	1124285	VNGA 160404 Z1	VNGA 331 Z1	○	○	9,53	4,76	0,40	3,81	0,00	3,50	0,10	0,07	0,40	0,10	0,07	0,20
	1124286	VNGA 160408 Z1	VNGA 332 Z1	○	○	9,53	4,76	0,80	3,81	0,00	3,50	0,20	0,08	0,80	0,15	0,08	0,30
	1124287	VNGA 160412 Z1	VNGA 333 Z1	○	○	9,53	4,76	1,20	3,81	0,00	3,50	0,25	0,10	1,20	0,17	0,10	0,35

Stock Items | Itens de stock

○ Available under request | Disponível sob consulta | Disponible bajo consulta

Insert Order Code: ⁽¹⁾Geometry code + ⁽²⁾Grade code

POSITIVE INSERTS

OVERVIEW | VISTA GENÉRICA | VISIÓN GENERAL

SINGLE TIP

SCGT Z1		SCGW Z1					
							
Size 06 09 12		Size 06 09 12					
Page 487							
CCGT Z1		CCGW Z1		CPGT Z1		CPGW Z1	
							
Size 06 09 12		Size 06 09 12		Size 06 09 12		Size 06 09 12	
Page 488				Page 489			
DCGT Z1		DCGW Z1					
							
Size 07 11		Size 07 11 15					
Page 490							
VCGT Z1		VCGW Z1					
							
Size 07 11 16		Size 07 11 16					
Page 491							
TCGT Z1		TCGW Z1		TPGT Z1		TPGW Z1	
							
Size 09 11 16		Size 09 11 16		Size 11 16		Size 11 16	
Page 492				Page 493			

FULL EDGE

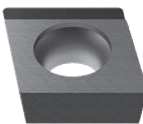
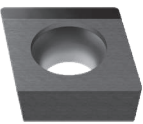
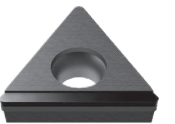
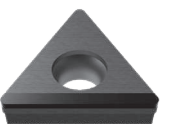
CCGT FR/FL		CCGW FR/FL		TCGT FL		TCGW FL	
							
Size 06 09 12		Size 06 09 12		Size 11 16		Size 11 16 22	
Page 494				Page 495			

SC = SQUARE 90° POSITIVE
 QUADRADA 90° POSITIVA | ESQUADRA 90° POSITIVA

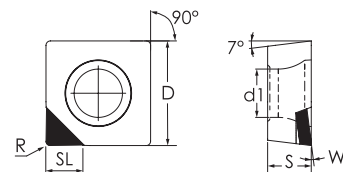

SCGT Z1

	⁽¹⁾ Geometry code	⁽²⁾ Grade code		N		Dimensions Dimensões Dimensiones (mm)						Cutting conditions Condições de corte Condiciones de corte					
		ISO Reference	ANSI Reference	D6	I3	D	S	R	d1	W	SL	ap (mm)	Min	Max	fn (mm/r)	Min	Max
				PDP410	PDP403												
	1124386	SCGT 060202 Z1	SCGT 21.50.5 Z1	○	○	6,35	2,38	0,20	2,80	7°	3,50	0,08	0,05	0,20	0,07	0,05	0,15
	1124387	SCGT 060204 Z1	SCGT 21.51 Z1	○	○	6,35	2,38	0,40	2,80	7°	3,50	0,10	0,05	0,40	0,09	0,05	0,20
	1124388	SCGT 09T304 Z1	SCGT 32.51 Z1	○	○	9,52	3,97	0,40	4,40	10°	3,50	0,10	0,07	0,40	0,10	0,05	0,20
	1124389	SCGT 09T308 Z1	SCGT 32.52 Z1	○	○	9,52	3,97	0,80	4,40	10°	3,50	0,20	0,08	0,80	0,15	0,07	0,30
	1124390	SCGT 120404 Z1	SCGT 431 Z1	○	○	12,70	4,76	0,40	5,50	10°	3,50	0,12	0,07	0,40	0,10	0,05	0,20
	1124391	SCGT 120408 Z1	SCGT 432 Z1	⊗	○	12,70	4,76	0,80	5,50	10°	3,50	0,22	0,08	0,80	0,15	0,08	0,30

⊗ Stock items | Itens de stock

○ Available under request | Disponível sob consulta | Disponible bajo consulta

Insert Order Code: ⁽¹⁾Geometry code + ⁽²⁾Grade code

SCGW Z1

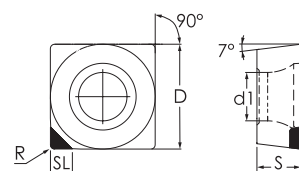

	⁽¹⁾ Geometry code	⁽²⁾ Grade code		N		Dimensions Dimensões Dimensiones (mm)						Cutting conditions Condições de corte Condiciones de corte					
		ISO Reference	ANSI Reference	D6	I3	D	S	R	L	W	SL	ap (mm)	Min	Max	fn (mm/r)	Min	Max
				PDP410	PDP403												
	1124237	SCGW 060202 Z1	SCGW 21.50.5 Z1	○	○	6,35	2,38	0,20	6,35	-	3,50	0,08	0,05	0,20	0,07	0,05	0,15
	1124238	SCGW 060204 Z1	SCGW 21.51 Z1	○	○	6,35	2,38	0,40	6,35	-	3,50	0,10	0,05	0,40	0,09	0,05	0,20
	1124239	SCGW 09T304 Z1	SCGW 32.51 Z1	○	○	9,53	3,97	0,40	9,53	-	3,50	0,10	0,07	0,40	0,10	0,05	0,20
	1124240	SCGW 09T308 Z1	SCGW 32.52 Z1	○	○	9,53	3,97	0,80	9,53	-	3,50	0,20	0,08	0,80	0,15	0,07	0,30
	1124241	SCGW 120404 Z1	SCGW 431 Z1	○	○	12,70	4,76	0,40	12,70	-	3,50	0,12	0,07	0,40	0,10	0,05	0,20
	1124242	SCGW 120408 Z1	SCGW 432 Z1	○	○	12,70	4,76	0,80	12,70	-	3,50	0,22	0,08	0,80	0,15	0,08	0,30

⊗ Stock items | Itens de stock

○ Available under request | Disponível sob consulta | Disponible bajo consulta

Insert Order Code: ⁽¹⁾Geometry code + ⁽²⁾Grade code

POSITIVE INSERTS

CC - RHOMBIC 80° POSITIVE

RÔMBICA 80° POSITIVA | RÓMBICA 80° POSITIVA

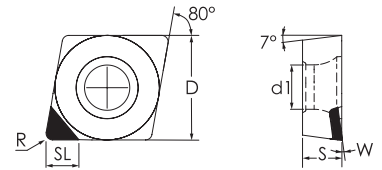

CCGT Z1

	(1) Geometry code	(2) Grade code		N		Dimensions Dimensões Dimensiones (mm)						Cutting conditions Condições de corte Condiciones de corte					
		ISO Reference	ANSI Reference	D6	I3	D	S	R	d1	W	SL	ap (mm)	Min	Max	fn (mm/r)	Min	Max
	1124113	CCGT 060202 Z1	CCGT 21.50.5 Z1	⊗	○	6,35	2,38	0,20	2,80	7°	3,50	0,08	0,05	0,20	0,08	0,05	0,15
	1124209	CCGT 060204 Z1	CCGT 21.51 Z1	○	○	6,35	2,38	0,40	2,80	7°	3,50	0,10	0,07	0,40	0,12	0,07	0,25
	1112592	CCGT 09T304 Z1	CCGT 32.51 Z1	⊗	○	9,53	3,97	0,40	4,40	10°	3,50	0,10	0,07	0,40	0,12	0,07	0,25
	1124210	CCGT 09T308 Z1	CCGT 32.52 Z1	○	○	9,53	3,97	0,80	4,40	10°	3,50	0,20	0,08	0,80	0,15	0,08	0,30
	1124211	CCGT 120404 Z1	CCGT 431 Z1	○	○	12,70	4,76	0,40	5,50	10°	3,50	0,10	0,07	0,40	0,12	0,07	0,25
	1112630	CCGT 120408 Z1	CCGT 432 Z1	⊗	○	12,70	4,76	0,80	5,50	10°	3,50	0,20	0,08	0,80	0,15	0,08	0,30
	1124465	CCGT 09T304-NF Z1	CCGT 32.51-NF Z1	⊗	○	9,53	3,97	0,40	4,40	-	4,00	0,12	0,07	0,40	0,15	0,07	0,25

⊗ Stock items | Itens de stock

○ Available under request | Disponível sob consulta | Disponible bajo consulta

Insert Order Code: (1) Geometry code + (2) Grade code

CCGW Z1

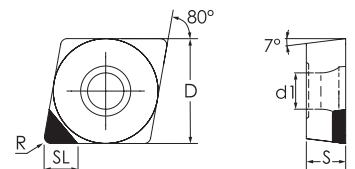

	(1) Geometry code	(2) Grade code		N		Dimensions Dimensões Dimensiones (mm)						Cutting conditions Condições de corte Condiciones de corte					
		ISO Reference	ANSI Reference	D6	I3	D	S	R	d1	W	SL	ap (mm)	Min	Max	fn (mm/r)	Min	Max
	1124114	CCGW 060202 Z1	CCGW 21.50.5 Z1	⊗	○	6,35	2,38	0,20	2,80	-	3,50	0,08	0,05	0,20	0,08	0,05	0,13
	1124218	CCGW 060204 Z1	CCGW 21.51 Z1	○	○	6,35	2,38	0,40	2,80	-	3,50	0,10	0,07	0,40	0,11	0,07	0,23
	1124219	CCGW 09T302 Z1	CCGW 32.50.5 Z1	○	○	9,53	3,97	0,20	4,40	-	3,50	0,08	0,05	0,20	0,08	0,05	0,15
	1112593	CCGW 09T304 Z1	CCGW 32.51 Z1	⊗	○	9,53	3,97	0,40	4,40	-	3,50	0,10	0,07	0,40	0,12	0,06	0,25
	1124220	CCGW 09T308 Z1	CCGW 32.2 Z1	○	○	9,53	3,97	0,80	4,40	-	3,50	0,20	0,08	0,80	0,15	0,08	0,30
	1124221	CCGW 120404 Z1	CCGW 431 Z1	⊗	○	12,70	4,76	0,40	5,50	-	3,50	0,10	0,07	0,40	0,12	0,06	0,25
	1112631	CCGW 120408 Z1	CCGW 432 Z1	⊗	○	12,70	4,76	0,80	5,50	-	3,50	0,20	0,08	0,80	0,15	0,08	0,30

⊗ Stock items | Itens de stock

○ Available under request | Disponível sob consulta | Disponible bajo consulta

Insert Order Code: (1) Geometry code + (2) Grade code

CP = RHOMBIC 80° POSITIVE
RÔMBICA 80° POSITIVA | RÓMBICA 80° POSITIVA

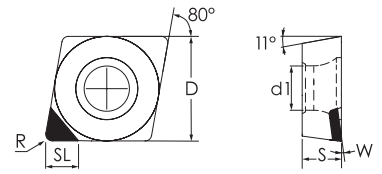

CPGT Z1

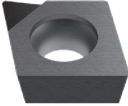
	⁽¹⁾ Geometry code	⁽²⁾ Grade code		N		Dimensions Dimensões Dimensiones (mm)						Cutting conditions Condições de corte Condiciones de corte					
		ISO Reference	ANSI Reference	D6	I3	D	S	R	d1	W	SL	ap (mm)	Min	Max	fn (mm/r)	Min	Max
	1124392	CPGT 060202 Z1	CCGT 21.50.5 Z1	○	○	6,35	2,38	0,20	2,80	7°	3,50	0,08	0,05	0,2	0,08	0,05	0,15
	1124393	CPGT 060204 Z1	CCGT 21.51 Z1	○	○	6,35	2,38	0,40	2,80	7°	3,50	0,10	0,07	0,4	0,12	0,07	0,25
	1124394	CPGT 09T304 Z1	CCGT 32.51 Z1	○	○	9,53	3,97	0,40	4,40	10°	3,50	0,10	0,07	0,4	0,12	0,07	0,25
	1124395	CPGT 09T308 Z1	CCGT 32.52 Z1	○	○	9,53	3,97	0,80	4,40	10°	3,50	0,20	0,08	0,8	0,15	0,08	0,30
	1124396	CPGT 120404 Z1	CCGT 431 Z1	○	○	12,70	4,76	0,40	5,50	10°	3,50	0,10	0,07	0,4	0,12	0,07	0,25
	1124397	CPGT 120408 Z1	CCGT 432 Z1	○	○	12,70	4,76	0,80	5,50	10°	3,50	0,20	0,08	0,8	0,15	0,08	0,30

Stock Items | Itens de stock

Available under request | Disponível sob consulta | Disponible bajo consulta

Insert Order Code: ⁽¹⁾Geometry code + ⁽²⁾Grade code

CPGW Z1

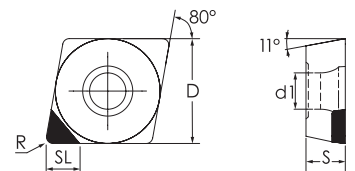

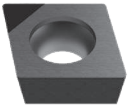
	⁽¹⁾ Geometry code	⁽²⁾ Grade code		N		Dimensions Dimensões Dimensiones (mm)						Cutting conditions Condições de corte Condiciones de corte					
		ISO Reference	ANSI Reference	D6	I3	D	S	R	d1	W	SL	ap (mm)	Min	Max	fn (mm/r)	Min	Max
	1124398	CPGW 060202 Z1	CPGW 21.50.5 Z1	○	○	6,35	2,38	0,20	2,80	-	3,50	0,08	0,05	0,20	0,08	0,05	0,13
	1124399	CPGW 060204 Z1	CPGW 21.51 Z1	○	○	6,35	2,38	0,40	2,80	-	3,50	0,10	0,07	0,40	0,11	0,07	0,23
	1124400	CPGW 09T302 Z1	CPGW 32.50.5 Z1	○	○	9,53	3,97	0,20	4,40	-	3,50	0,08	0,05	0,20	0,08	0,05	0,15
	1124401	CPGW 09T304 Z1	CPGW 32.51 Z1	○	○	9,53	3,97	0,40	4,40	-	3,50	0,10	0,07	0,40	0,12	0,06	0,25
	1124402	CPGW 09T308 Z1	CPGW 32.52 Z1	○	○	9,53	3,97	0,80	4,40	-	3,50	0,20	0,08	0,80	0,15	0,08	0,30
	1124403	CPGW 120404 Z1	CPGW 431 Z1	○	○	12,70	4,76	0,40	5,50	-	3,50	0,10	0,07	0,40	0,12	0,06	0,25
	1124404	CPGW 120408 Z1	CPGW 432 Z1	○	○	12,70	4,76	0,80	5,50	-	3,50	0,20	0,08	0,80	0,15	0,08	0,30

Stock Items | Itens de stock

Available under request | Disponível sob consulta | Disponible bajo consulta

Insert Order Code: ⁽¹⁾Geometry code + ⁽²⁾Grade code

POSITIVE INSERTS

DC - RHOMBIC 55° POSITIVE

RÔMBICA 55° POSITIVA | RÓMBICA 55° POSITIVA

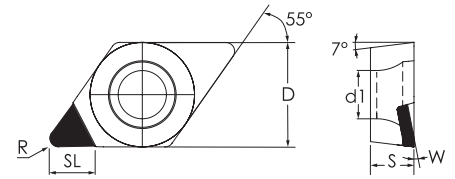

DCGT Z1

	(1) Geometry code	(2) Grade code		N		Dimensions Dimensões Dimensiones (mm)						Cutting conditions Condições de corte Condiciones de corte					
		ISO Reference	ANSI Reference	D6	I3	D	S	R	d1	W	SL	ap (mm)	Min	Max	fn (mm/r)	Min	Max
				PDP410	PDP403												
	1124116	DCGT 070202 Z1	DCGT 21.50.5 Z1	⊗	○	6,35	2,38	0,20	2,80	7°	3,50	0,08	0,05	0,20	0,08	0,05	0,15
	1124231	DCGT 070204 Z1	DCGT 21.51 Z1	○	○	6,35	2,38	0,40	2,80	7°	3,50	0,10	0,07	0,40	0,10	0,05	0,20
	1112634	DCGT 11T304 Z1	DCGT 32.501 Z1	⊗	○	9,53	3,97	0,40	4,40	10°	3,50	0,10	0,07	0,40	0,10	0,05	0,20
	1124380	DCGT 11T308 Z1	DCGT 32.52 Z1	⊗	⊗	9,53	3,97	0,80	4,40	10°	3,50	0,20	0,08	0,80	0,15	0,08	0,30

⊗ Stock Items | Itens de stock

○ Available under request | Disponível sob consulta | Disponible bajo consulta

Insert Order Code: (1) Geometry code + (2) Grade code

DCGW Z1

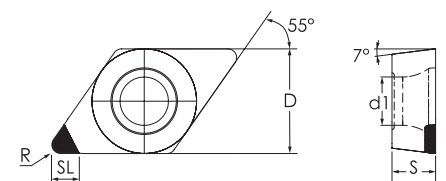

	(1) Geometry code	(2) Grade code		N		Dimensions Dimensões Dimensiones (mm)						Cutting conditions Condições de corte Condiciones de corte					
		ISO Reference	ANSI Reference	D6	I3	D	S	R	d1	W	SL	ap (mm)	Min	Max	fn (mm/r)	Min	Max
				PDP410	PDP403												
	1124232	DCGW 070202 Z1	DCGW 21.50.5 Z1	⊗	○	6,35	2,38	0,20	2,80	-	3,50	0,08	0,05	0,20	0,08	0,05	0,15
	1124233	DCGW 070204 Z1	DCGW 21.51 Z1	⊗	○	6,35	2,38	0,40	2,80	-	3,50	0,10	0,07	0,40	0,10	0,05	0,20
	1124458	DCGW 11T302 Z1	DCGW 32.50.5 Z1	⊗	○	9,53	3,97	0,20	4,40	-	3,50	0,10	0,05	0,35	0,10	0,05	0,15
	1112635	DCGW 11T304 Z1	DCGW 32.51 Z1	⊗	○	9,53	3,97	0,40	4,40	-	3,50	0,10	0,07	0,40	0,10	0,05	0,20
	1124168	DCGW 11T308 Z1	DCGW 32.52 Z1	⊗	○	9,53	3,97	0,80	4,40	-	3,50	0,20	0,08	0,80	0,15	0,08	0,30
	1124234	DCGW 150404 Z1	DCGW 431 Z1	○	○	12,70	4,76	0,40	5,50	-	3,50	0,10	0,08	0,40	0,10	0,05	0,20
	1124117	DCGW 150408 Z1	DCGW 432 Z1	⊗	○	12,70	4,76	0,80	5,50	-	3,50	0,20	0,10	0,80	0,15	0,08	0,30

⊗ Stock Items | Itens de stock

○ Available under request | Disponível sob consulta | Disponible bajo consulta

Insert Order Code: (1) Geometry code + (2) Grade code

VC = RHOMBIC 35° POSITIVE

RÔMBICA 35° POSITIVA | RÓMBICA 35° POSITIVA

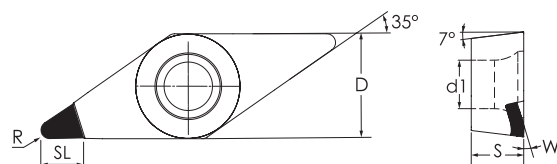

VCGT Z1

	(1) Geometry code	(2) Grade code		N		Dimensions Dimensões Dimensiones (mm)						Cutting conditions Condições de corte Condiciones de corte					
		ISO Reference	ANSI Reference	D6	I3	D	S	R	d1	W	SL	ap (mm)	Min	Max	fn (mm/r)	Min	Max
				PDP410	PDP403												
	1124275	VCGT 070202 Z1	VCGT 1.31.50.5 Z1	○	○	3,97	2,38	0,20	2,20	7°	3,00	0,08	0,05	0,20	0,08	0,03	0,10
	1124276	VCGT 070204 Z1	VCGT 1.31.51 Z1	○	○	3,97	2,38	0,40	2,20	7°	3,00	0,10	0,07	0,40	0,10	0,05	0,20
	1124277	VCGT 110302 Z1	VCGT 220.5 Z1	○	○	6,35	3,18	0,20	2,80	10°	3,50	0,08	0,05	0,20	0,08	0,03	0,10
	1124071	VCGT 110304 Z1	VCGT 221 Z1	⊗	⊗	6,35	3,18	0,40	2,80	10°	3,50	0,10	0,07	0,40	0,10	0,05	0,20
	1124278	VCGT 160404 Z1	VCGT 331 Z1	○	○	9,53	4,76	0,40	4,40	10°	3,50	0,10	0,07	0,40	0,10	0,05	0,20
	1112640	VCGT 160408 Z1	VCGT 332 Z1	⊗	○	9,53	4,76	0,80	4,40	10°	3,50	0,20	0,08	0,80	0,15	0,08	0,30
	1124279	VCGT 160412 Z1	VCGT 333 Z1	○	○	9,53	4,76	1,20	4,40	10°	3,50	0,30	0,10	1,20	0,17	0,08	0,35

⊗ Stock Items | Itens de stock

○ Available under request | Disponível sob consulta | Disponible bajo consulta

Insert Order Code: (1) Geometry code + (2) Grade code

VCGW Z1

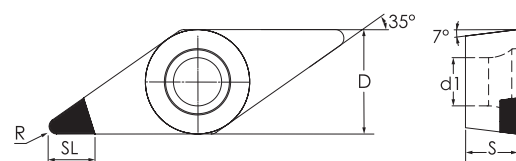

	(1) Geometry code	(2) Grade code		N		Dimensions Dimensões Dimensiones (mm)						Cutting conditions Condições de corte Condiciones de corte					
		ISO Reference	ANSI Reference	D6	I3	D	S	R	d1	W	SL	ap (mm)	Min	Max	fn (mm/r)	Min	Max
				PDP410	PDP403												
	1124280	VCGW 070202 Z1	VCGW 1.31.50.5 Z1	○	○	3,97	2,38	0,20	2,20	-	3,00	0,08	0,05	0,20	0,08	0,03	0,10
	1124281	VCGW 070204 Z1	VCGW 1.31.51 Z1	⊗	○	3,97	2,38	0,40	2,20	-	3,00	0,10	0,07	0,40	0,10	0,05	0,20
	1124378	VCGW 110304 Z1	VCGW 221 Z1	○	○	6,35	3,18	0,40	2,80	-	3,50	0,10	0,07	0,40	0,10	0,05	0,20
	1124282	VCGW 110308 Z1	VCGW 222 Z1	○	○	6,35	3,18	0,80	2,80	-	3,50	0,20	0,08	0,80	0,15	0,08	0,30
	1124283	VCGW 160404 Z1	VCGW 331 Z1	⊗	○	9,53	4,76	0,40	4,40	-	3,50	0,10	0,07	0,40	0,10	0,05	0,20
	1112641	VCGW 160408 Z1	VCGW 332 Z1	⊗	○	9,53	4,76	0,80	4,40	-	4,00	0,20	0,08	0,80	0,15	0,08	0,30
	1124284	VCGW 160412 Z1	VCGW 333 Z1	○	○	9,53	4,76	1,20	4,40	-	3,50	0,30	0,10	1,20	0,17	0,08	0,35

⊗ Stock Items | Itens de stock

○ Available under request | Disponível sob consulta | Disponible bajo consulta

Insert Order Code: (1) Geometry code + (2) Grade code

POSITIVE INSERTS

TC - TRIANGULAR 60° POSITIVE

TRIANGULAR 60° POSITIVA | TRIANGULAR 60° POSITIVA

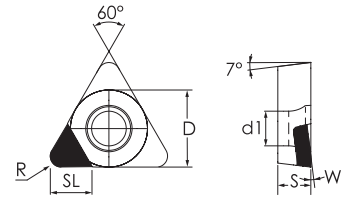

TCGT Z1

	(1) Geometry code	(2) Grade code		N		Dimensions Dimensões Dimensiones (mm)						Cutting conditions Condições de corte Condiciones de corte					
		ISO Reference	ANSI Reference	D6	I3	D	S	R	d1	W	SL	ap (mm)	Min	Max	fn (mm/r)	Min	Max
				PDP410	PDP403												
	1124186	TCGT 090202 Z1	TCGT 1.81.50.5 Z1	⊗	○	5,56	2,38	0,20	2,50	7°	3,00	0,07	0,04	0,20	0,07	0,03	0,10
	1124188	TCGT 090204 Z1	TCGT 1.81.51 Z1	⊗	○	5,56	2,38	0,40	2,50	7°	3,00	0,10	0,07	0,40	0,10	0,05	0,20
	1124119	TCGT 110204 Z1	TCGT 21.51 Z1	⊗	○	6,35	2,38	0,40	2,80	7°	3,00	0,10	0,07	0,40	0,10	0,05	0,20
	1124190	TCGT 110208 Z1	TCGT 21.52 Z1	⊗	○	6,35	2,38	0,80	2,80	7°	3,00	0,20	0,08	0,80	0,15	0,08	0,30
	1124247	TCGT 16T304 Z1	TCGT 32.51 Z1	○	○	9,53	3,97	0,40	4,40	10°	3,00	0,10	0,07	0,40	0,10	0,05	0,20
	1112637	TCGT 16T308 Z1	TCGT 32.52 Z1	⊗	○	9,53	3,97	0,80	4,40	10°	3,00	0,20	0,08	0,80	0,15	0,08	0,30

⊗ Stock Items | Itens de stock

○ Available under request | Disponível sob consulta | Disponible bajo consulta

Insert Order Code: (1) Geometry code + (2) Grade code

TCGW Z1

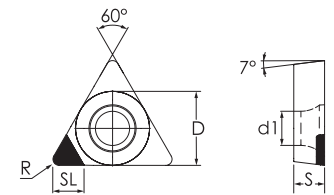

	(1) Geometry code	(2) Grade code		N		Dimensions Dimensões Dimensiones (mm)						Cutting conditions Condições de corte Condiciones de corte					
		ISO Reference	ANSI Reference	D6	I3	D	S	R	d1	W	SL	ap (mm)	Min	Max	fn (mm/r)	Min	Max
				PDP410	PDP403												
	1124185	TCGW 090202 Z1	TCGW 1.81.50.5 Z1	⊗	○	5,56	2,38	0,20	2,50	-	3,00	0,07	0,04	0,20	0,07	0,03	0,10
	1124187	TCGW 090204 Z1	TCGW 1.81.51 Z1	⊗	○	5,56	2,38	0,40	2,50	-	3,00	0,10	0,07	0,40	0,10	0,05	0,20
	1124507	TCGW 110202 Z1	TCGW 21.50.5 Z1	⊗	○	6,35	2,38	0,20	2,80	-	3,00	0,07	0,04	0,20	0,07	0,03	0,10
	1124192	TCGW 110204 Z1	TCGW 21.51 Z1	⊗	○	6,35	2,38	0,40	2,80	-	3,50	0,10	0,07	0,40	0,10	0,05	0,20
	1124189	TCGW 110208 Z1	TCGW 21.52 Z1	⊗	○	6,35	2,38	0,80	2,80	-	3,50	0,20	0,08	0,80	0,15	0,08	0,30
	1124251	TCGW 16T304 Z1	TCGW 32.51 Z1	○	○	9,53	3,97	0,40	4,40	-	3,50	0,10	0,07	0,40	0,10	0,05	0,20
	1112638	TCGW 16T308 Z1	TCGW 32.52 Z1	⊗	○	9,53	3,97	0,80	4,40	-	3,50	0,20	0,08	0,80	0,15	0,08	0,30

⊗ Stock Items | Itens de stock

○ Available under request | Disponível sob consulta | Disponible bajo consulta

Insert Order Code: (1) Geometry code + (2) Grade code

TP - TRIANGULAR 60° POSITIVE

TRIANGULAR 60° POSITIVA | TRIANGULAR 60° POSITIVA

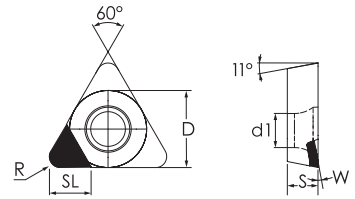

TPGT Z1

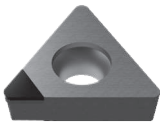

	(1) Geometry code	(2) Grade code		N		Dimensions Dimensões Dimensiones (mm)						Cutting conditions Condições de corte Condiciones de corte					
		ISO Reference	ANSI Reference	D6	I3	D	S	R	d1	W	SL	ap (mm)	Min	Max	fn (mm/r)	Min	Max
				PDP410	PDP403												
	1124260	TPGT 110302 Z1	TPGT 220.5 Z1	○	○	6,35	3,18	0,20	3,40	10°	3,50	0,07	0,04	0,20	0,07	0,05	0,10
	1124261	TPGT 110304 Z1	TPGT 221 Z1	○	○	6,35	3,18	0,40	3,40	10°	3,50	0,10	0,07	0,40	0,10	0,05	0,20
	1124262	TPGT 110308 Z1	TPGT 222 Z1	○	○	6,35	3,18	0,80	3,40	10°	3,50	0,20	0,08	0,80	0,15	0,08	0,30
	1124263	TPGT 16T304 Z1	TPGT 32.51 Z1	○	○	9,53	3,97	0,40	4,30	10°	3,50	0,10	0,07	0,40	0,10	0,05	0,20
	1124174	TPGT 16T308 Z1	TPGT 32.52 Z1	○	○	9,53	3,97	0,80	4,30	10°	3,50	0,20	0,08	0,80	0,15	0,08	0,30
	1124264	TPGT 160404 Z1	TPGT 331 Z1	○	○	9,53	4,76	0,40	4,30	10°	3,50	0,10	0,07	0,40	0,10	0,05	0,20
	1124265	TPGT 160408 Z1	TPGT 332 Z1	○	○	9,53	4,76	0,80	4,30	10°	3,50	0,20	0,08	0,80	0,15	0,08	0,30

Stock Items | Itens de stock

Available under request | Disponível sob consulta | Disponible bajo consulta

Insert Order Code: (1) Geometry code + (2) Grade code

TPGW Z1

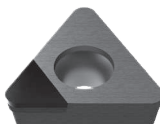
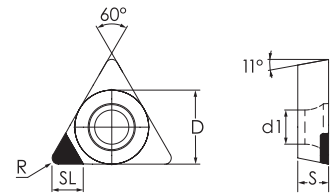

	(1) Geometry code	(2) Grade code		N		Dimensions Dimensões Dimensiones (mm)						Cutting conditions Condições de corte Condiciones de corte					
		ISO Reference	ANSI Reference	D6	I3	D	S	R	d1	W	SL	ap (mm)	Min	Max	fn (mm/r)	Min	Max
				PDP410	PDP403												
	1124266	TPGW 110202 Z1	TPGW 21.50.5 Z1	○	○	6,35	2,38	0,20	2,80	-	3,50	0,07	0,04	0,20	0,07	0,05	0,10
	1124267	TPGW 110204 Z1	TPGW 21.51 Z1	○	○	6,35	2,38	0,40	2,80	-	3,50	0,10	0,07	0,40	0,10	0,05	0,20
	1124268	TPGW 110208 Z1	TPGW 21.52 Z1	○	○	6,35	2,38	0,80	2,80	-	3,50	0,20	0,08	0,80	0,15	0,08	0,30
	1124269	TPGW 110302 Z1	TPGW 220.5 Z1	○	○	6,35	3,18	0,20	2,80	-	3,50	0,07	0,04	0,20	0,07	0,05	0,10
	1124270	TPGW 110304 Z1	TPGW 221 Z1	⊗	○	6,35	3,18	0,40	2,80	-	3,50	0,10	0,07	0,40	0,10	0,05	0,20
	1124379	TPGW 110308 Z1	TPGW 222 Z1	⊗	○	6,35	3,18	0,80	2,80	-	3,50	0,20	0,08	0,80	0,15	0,08	0,30
	1124271	TPGW 16T304 Z1	TPGW 32.51 Z1	○	○	9,53	3,97	0,40	4,30	-	3,50	0,10	0,07	0,40	0,10	0,05	0,20
	1124272	TPGW 16T308 Z1	TPGW 32.52 Z1	○	○	9,53	3,97	0,80	4,30	-	3,50	0,20	0,08	0,80	0,15	0,08	0,30
	1124273	TPGW 160404 Z1	TPGW 331 Z1	○	○	9,53	4,76	0,40	4,30	-	3,50	0,10	0,07	0,40	0,10	0,05	0,20
	1124274	TPGW 160408 Z1	TPGW 332 Z1	○	○	9,53	4,76	0,80	4,30	-	3,50	0,20	0,08	0,80	0,15	0,08	0,30

Stock Items | Itens de stock

Available under request | Disponível sob consulta | Disponible bajo consulta

Insert Order Code: (1) Geometry code + (2) Grade code

POSITIVE INSERTS

CC - RHOMBIC 80° POSITIVE

RÔMBICA 80° POSITIVA | RÓMBICA 80° POSITIVA

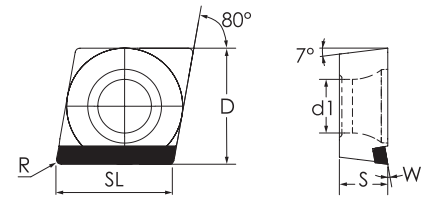

CCGT FR/FL

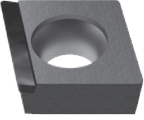
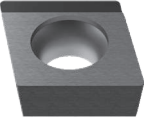
	(1) Geometry code	(2) Grade code		N		Dimensions Dimensões Dimensiones (mm)							Cutting conditions Condições de corte Condiciones de corte				
		ISO Reference	ANSI Reference	D6	I3	L	S	R	D	W	SL	ap (mm)	Min	Max	fn (mm/r)	Min	Max
				PDP410	PDP403												
 CCGT FR	1124212	CCGT 09T302 FR	CCGT 32.50.5 FR	○	○	9,53	3,97	0,20	4,40	10°	9,70	4,85	0,2	6,40	0,08	0,05	0,15
	1124165	CCGT 09T304 FR	CCGT 32.51 FR	⊗	○	9,53	3,97	0,40	4,40	10°	9,70	4,85	0,40	6,40	0,12	0,07	0,25
	1124213	CCGT 120404 FR	CCGT 431 FR	○	○	12,70	4,76	0,40	5,50	10°	12,90	6,45	0,40	8,50	0,15	0,08	0,30
	1124214	CCGT 120408 FR	CCGT 432 FR	○	○	12,70	4,76	0,80	5,50	10°	12,90	6,45	0,80	8,50	0,3	0,1	0,40
 CCGT FL	1124215	CCGT 09T302 FL	CCGT 32.50.5 FL	○	○	9,53	3,97	0,20	4,40	10°	9,70	4,85	0,20	6,40	0,08	0,05	0,15
	1124166	CCGT 09T304 FL	CCGT 32.51 FL	⊗	○	9,53	3,97	0,40	4,40	10°	9,70	4,85	0,40	6,40	0,12	0,07	0,25
	1124216	CCGT 120404 FL	CCGT 431 FL	○	○	12,70	4,76	0,40	5,50	10°	12,90	6,45	0,40	8,50	0,15	0,08	0,30
	1124217	CCGT 120408 FL	CCGT 432 FL	○	○	12,70	4,76	0,80	5,50	10°	12,90	6,45	0,80	8,50	0,3	0,1	0,40

⊗ Stock Itens | Itens de stock

○ Available under request | Disponível sob consulta | Disponible bajo consulta

Insert Order Code: (1) Geometry code + (2) Grade code

CCGW FR/FL

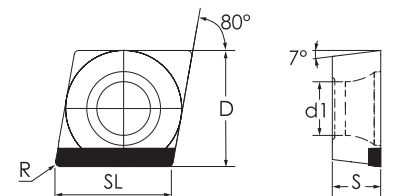

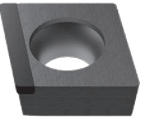
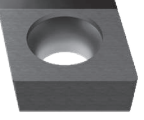
	(1) Geometry code	(2) Grade code		N		Dimensions Dimensões Dimensiones (mm)							Cutting conditions Condições de corte Condiciones de corte				
		ISO Reference	ANSI Reference	D6	I3	D	S	R	d1	W	SL	ap (mm)	Min	Max	fn (mm/r)	Min	Max
				PDP410	PDP403												
 CCGW FR	1124547	CCGW 060204 FR	CCGW 21.51 FR	⊗	○	9,53	3,97	0,4	4,4	-	9,7	4,85	0,4	6,4	0,12	0,07	0,25
	1124170	CCGW 09T304 FR	CCGW 32.51 FR	○	○	9,53	3,97	0,4	4,4	-	9,7	4,85	0,4	6,4	0,12	0,07	0,25
	1124222	CCGW 09T308 FR	CCGW 32.52 FR	○	○	9,53	3,97	0,8	4,4	-	9,7	4,85	0,8	6,4	0,16	0,1	0,35
	1124223	CCGW 120404 FR	CCGW 431 FR	○	○	12,7	4,76	0,4	5,5	-	12,9	6,45	0,4	8,5	0,15	0,08	0,3
	1124224	CCGW 120408 FR	CCGW 432 FR	○	○	12,7	4,76	0,8	5,5	-	12,9	6,45	0,8	8,5	0,3	0,1	0,4
 CCGW FL	1124548	CCGW 060204 FL	CCGW 21.51 FL	⊗	○	6,35	2,38	0,4	2,8	-	6,5	3,25	0,4	4,2	0,08	0,07	0,25
	1124171	CCGW 09T304 FL	CCGW 32.51 FL	○	○	9,53	3,97	0,4	4,4	-	9,7	4,85	0,4	6,4	0,12	0,07	0,25
	1124225	CCGW 09T308 FL	CCGW 32.52 FL	○	○	9,53	3,97	0,8	4,4	-	9,7	4,85	0,8	6,4	0,16	0,1	0,35
	1124226	CCGW 120404 FL	CCGW 431 FL	○	○	12,7	4,76	0,4	5,5	-	12,9	6,45	0,4	8,5	0,15	0,08	0,3
	1124227	CCGW 120408 FL	CCGW 432 FL	⊗	○	12,7	4,76	0,8	5,5	-	12,9	6,45	0,8	8,5	0,3	0,1	0,4

⊗ Stock Itens | Itens de stock

○ Available under request | Disponível sob consulta | Disponible bajo consulta

Insert Order Code: (1) Geometry code + (2) Grade code

TC - TRIANGULAR 60° POSITIVE
 TRIÂNGULAR 60° POSITIVA | TRIANGULAR 60° POSITIVA

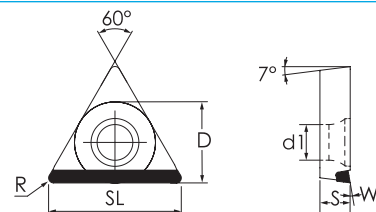

TCGT FL

	⁽¹⁾ Geometry code	⁽²⁾ Grade code		N		Dimensions Dimensões Dimensiones (mm)						Cutting conditions Condições de corte Condiciones de corte					
		ISO Reference	ANSI Reference	D6	I3	D	S	R	d1	W	SL	ap (mm)	Min	Max	fn (mm/r)	Min	Max
				PDP410	PDP403												
	1124173	TCGT 110204 FL	TCGT 21.51 FL	⊗	○	6,35	2,38	0,40	2,80	7°	10,41	5,20	0,40	6,90	0,10	0,05	0,20
	1124248	TCGT 110208 FL	TCGT 21.52 FL	○	○	6,35	2,38	0,80	2,80	7°	9,83	4,92	0,80	6,50	0,15	0,08	0,30
	1124249	TCGT 16T304 FL	TCGT 32.51 FL	○	○	9,53	3,97	0,40	4,40	10°	15,91	7,96	0,40	10,50	0,10	0,05	0,20
	1124250	TCGT 16T308 FL	TCGT 32.52 FL	○	○	9,53	3,97	0,80	4,40	10°	15,33	7,67	0,80	10,15	0,15	0,08	0,30

⊗ Stock Items | Itens de stock

○ Available under request | Disponível sob consulta | Disponible bajo consulta

Insert Order Code: ⁽¹⁾Geometry code + ⁽²⁾Grade code

Note: Can be used as FR geometry.

TCGW FL

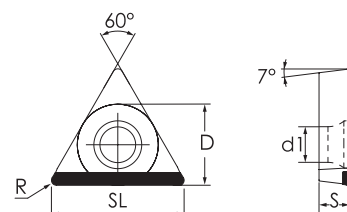

	⁽¹⁾ Geometry code	⁽²⁾ Grade code		N		Dimensions Dimensões Dimensiones (mm)						Cutting conditions Condições de corte Condiciones de corte					
		ISO Reference	ANSI Reference	D6	I3	D	S	R	d1	W	SL	ap (mm)	Min	Max	fn (mm/r)	Min	Max
				PDP410	PDP403												
	1124252	TCGW 110202 FL	TCGW 21.50.5 FL	○	○	6,35	2,38	0,20	2,80	-	10,71	5,20	0,40	6,90	0,10	0,05	0,20
	1112777	TCGW 110204 FL	TCGW 21.51 FL	⊗	○	6,35	2,38	0,40	2,80	-	10,41	5,21	0,80	6,50	0,15	0,08	0,30
	1124253	TCGW 16T304 FL	TCGW 32.51 FL	○	○	9,53	3,97	0,40	4,40	-	15,91	7,96	0,40	10,50	0,10	0,05	0,20
	1124254	TCGW 16T308 FL	TCGW 32.52 FL	○	○	9,53	3,97	0,80	4,40	-	15,33	7,67	0,80	10,15	0,15	0,08	0,30
	1124255	TCGW 220404 FL	TCGW 431 FL	○	○	12,70	4,76	0,40	5,50	-	21,40	8,00	0,40	10,70	0,10	0,08	0,20
	1112713	TCGW 220408 FL	TCGW 432 FL	⊗	○	12,70	4,76	0,80	5,50	-	20,83	7,84	0,80	10,45	0,15	0,10	0,30

⊗ Stock Items | Itens de stock

○ Available under request | Disponível sob consulta | Disponible bajo consulta

Insert Order Code: ⁽¹⁾Geometry code + ⁽²⁾Grade code

Note: Can be used as FR geometry.

PCD RECOMMENDED CUTTING DATA

Condições de corte recomendadas para PCD | Datos de corte recomendadas para PCD

Workpiece material	VC (m/min)		Recommend grade for PCD	
			PDP 410	PDP 403
Aluminium alloys: Aluminium, Si<14%	Roughing	800-3000	⊗	
	Finishing	800-3000	⊗	
Aluminium: Aluminium, Si≥14%	Roughing	300-700	○	⊗
	Finishing	250-700	○	⊗
Copper alloys: Copper, Zinc, Brass	Roughing	600-1200	⊗	
	Finishing	700-1500	⊗	
Metal matrix composites: Al (10-20%) SiC	Roughing	300-1150		⊗
	Finishing	400-1260		⊗
Tungsten carbide 10-16% Co: Unsintered	Roughing	50-200		⊗
	Finishing	60-220		⊗
Tungsten carbide 10-16% Co: Sintered	Roughing	20-40		⊗
	Finishing	25-45		⊗
Ebonite, Fiberglass, Plastic materials, Graphite, Glass.	Roughing	200-1500	⊗	⊗
	Finishing	300-2000	⊗	⊗
Ceramic: Unsintered	Roughing	50-150		⊗
	Finishing	50-200		⊗
Ceramic: Sintered	Roughing	20-35		⊗
	Finishing	20-40		⊗
Wood	Finishing	1000-4000	⊗	

⊗ Recommended ○ Second choice



BAR PEELING



BAR PEELING

Bar Peeling is the machining process by which a raw forged blank is converted into a polished bar.

During this peeling process, surface cracks and oxide layers are removed giving a perfect roundness with good surface and dimensional accuracy to the bar.

The range of materials that can be machined with these tools is vast and goes from all kind of Steels to Cast Iron parts.

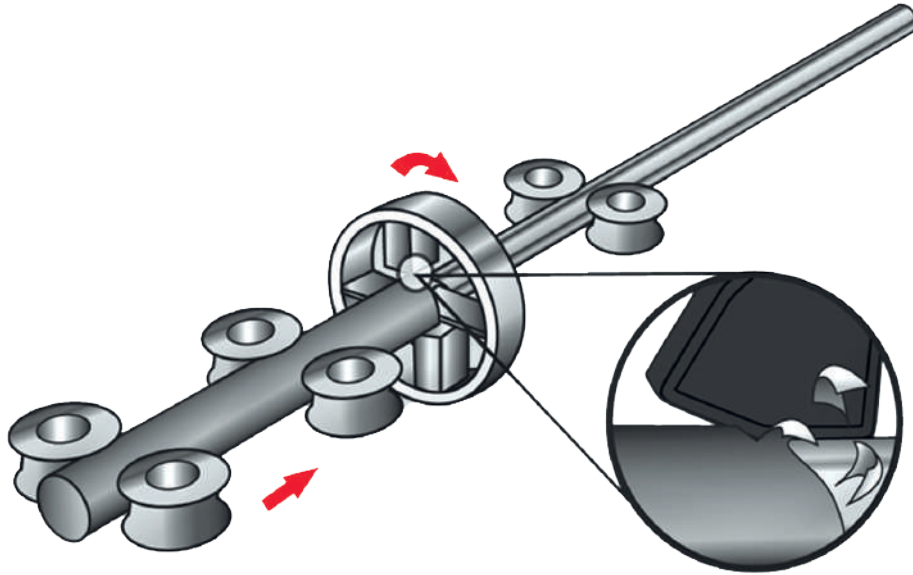

The size of blank bar can go from 4 mm (157 inch) to over 400 mm (15.75 inch) in diameter.

The surface quality and dimensional tolerances are also high, which leads to less machining at later stages.

Our aim is at the same time improving your productivity (by removing maximal chips volume) and, at the same time, matching or surpassing your surface quality requirements. This is why our Bar Peeling program is vast, comprising both standard tools and also special custom-made solutions to every customer needs.

This flyer has only a small portion of our possible range of production. Please don't hesitate to contact us regarding other possible geometries that we may have although not presented in this brochure.

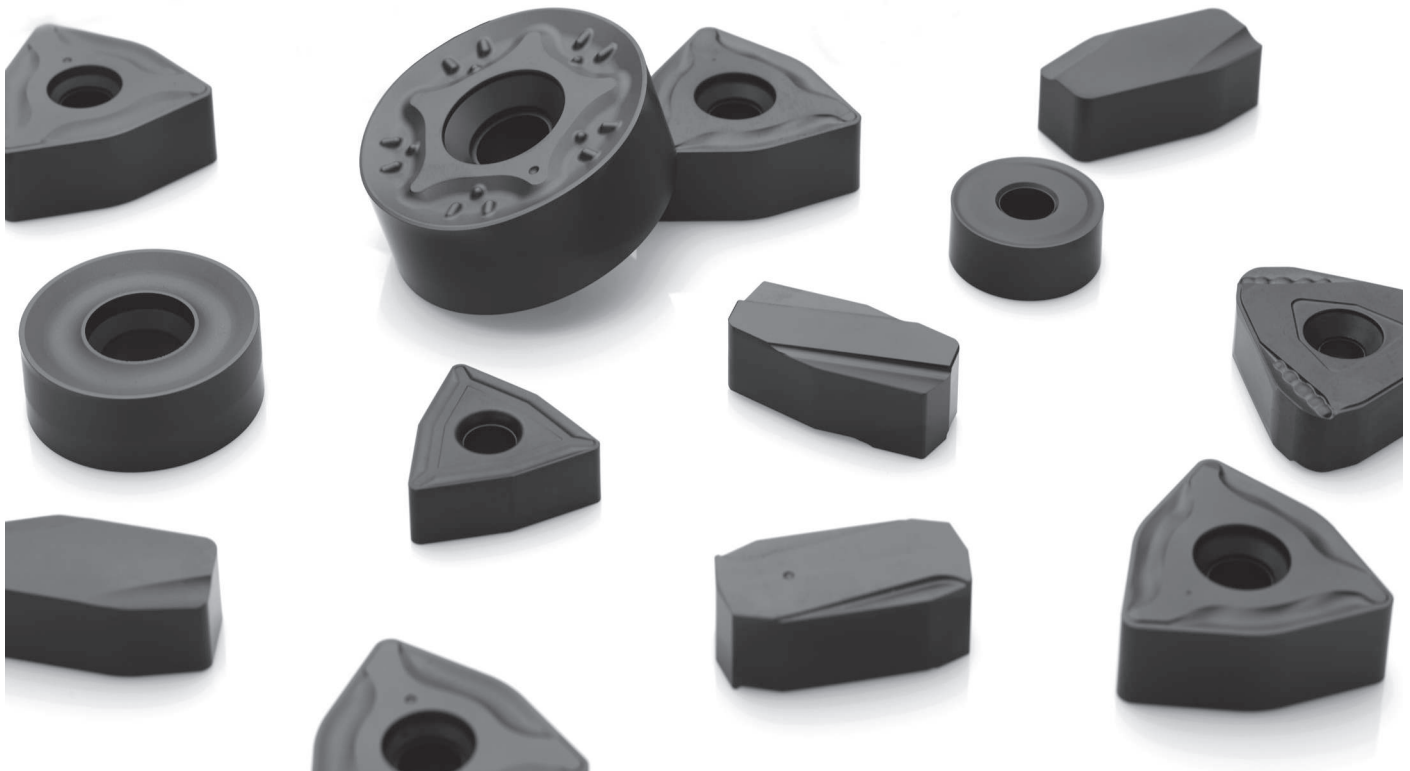

L	N	G	F	20	10	35	-	MP
1	2	3	4	5	6	7		8

1 - Insert Shape				
I	J	L	R	S
T	U	W	X	

2 - Clearance Angle

5 - Length of Cutting Edge (In)	
The length of the secondary cutting edge is indicated in mm	
13 mm	25 mm
14 mm	27 mm
15 mm	28 mm
17 mm	38 mm
20 mm	44 mm
22 mm	50 mm

3 - Tolerances			
symbol	m (mm)	d (mm)	s (mm)
A	±0.005	±0.025	±0.025
F	±0.005	±0.013	±0.025
C	±0.013	±0.025	±0.025
H	±0.013	±0.013	±0.025
E	±0.025	±0.025	±0.025
G	±0.025	±0.025	±0.13
J	±0.005	±0.05~±0.13	±0.025
K*	±0.013	±0.05~±0.13	±0.025
L*	±0.025	±0.05~±0.13	±0.025
M*	±0.08~±0.20	±0.05~±0.13	±0.13
N*	±0.08~±0.20	±0.05~±0.13	±0.025
U*	±0.13~±0.38	±0.08~0.25	±0.13

4 - Insert type				
symbol	Type	Type of hole	Chipbreaker	Shape
W	with hole	Round hole / one countersink (40°~60°)	Without chipbreaker	
T	with hole		Chipbreaker on one side	
Q	with hole	Round hole / one countersink (40°~60°)	Without chipbreaker	
U	with hole		Chipbreaker on both sides	
B	with hole	Round hole / one countersink (70°~90°)	Without chipbreaker	
H	with hole		Chipbreaker on one side	
C	with hole	Round hole / double countersink (70°~90°)	Without chipbreaker	
J	with hole		Chipbreaker on both sides	
A	with hole	Round hole	Without chipbreaker	
M	with hole		Chipbreaker on one side	
G	with hole		Chipbreaker on both sides	
N	without hole	--	Without chipbreaker	
R	without hole	--	Chipbreaker on one side	
F	without hole	--	Chipbreaker on both sides	
X	-	-	--	On request

6 - Thickness (S)
The length of the secondary cutting edge is indicated in mm
08 = 8,00 mm
09 = 9,52 mm
10 = 10,00 mm
12 = 12,00 mm
12 = 12,70 mm
13 = 13,00 mm
14 = 14,00 mm
18 = 18,00 mm







* As a rule, the sides of these inserts are as sintered. Tolerance differs with insert size, for the accuracy of Class M, refer to the table on the right.

8 - Chip Breaker	
Chip breaker according to Palbit geometries	
FP	MH
ST	RP
MP	LH

7 - Depth of Cut (ap)
Maximum depth of cut
20 = 2,00 mm
25 = 2,50 mm
35 = 3,50 mm
40 = 4,00 mm
80 = 8,00 mm

BAR PEELING INSERTS RANGE

NEGATIVE INSERTS | PASTILHAS NEGATIVAS | PLAQUITAS NEGATIVAS

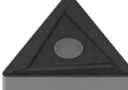
	(1) Geometry code	ISO Reference	ANSI Reference	new grades												Cutting conditions Condições de corte Condiciones de Corte							
				P						M						K		ap (mm)	Min	Max	fn (mm/r)	Min	Max
				L7	R2	L8	R3	N2	S9	L8	U5	N2	V7	P1	V8	L5	L6						
	1123828	INGR 221240-MP	INGR 221240-MP	△	⊗	○						○			○	○	2,00	0,40	4,00	3,50	1,00	8,00	
	1123830	JNGF 201220-MP	JNGF 201220-MP	○	△	⊗				△	⊗				○	○	1,50	1,00	2,00	3,50	1,50	6,00	
	1123996	JNGF 201220-MP SP1	JNGF 201220-MP SP1	○	○					○					○	○	1,50	1,00	2,00	3,50	1,50	6,00	
	1123997	JNGF 201220-MP SP2	JNGF 201220-MP SP2	△	⊗	△	⊗			△	⊗				○	○	1,50	1,00	2,00	3,50	1,50	6,00	
	1124043	JNGF 271220-MP	JNGF 271220-MP	○	○					△	⊗				○	○	1,50	1,00	2,00	3,50	1,50	6,00	
	1123826	LNGF 201035-MP	LNGF 201035-MP	△	⊗	○				○					○	○	2,00	0,80	3,50	2,50	1,00	6,50	
	1123827	LNGF 201235-MP	LNGF 201235-MP	△	⊗	○				○					○	○	2,00	0,80	3,50	2,50	1,00	6,50	
	1123829	UNGF 171240-MP	UNGF 171240-MP	○	△	⊗				△	⊗				○	○	1,50	0,35	4,00	2,00	1,00	5,00	
	1123838	TNMJ 201025-MP	TNMJ 201025-MP	○	△	⊗				△	⊗				○	○	1,00	0,70	2,50	3,00	1,00	5,50	
	1123843	TNMJ 201425-MP	TNMJ 201425-MP	○	△	⊗				△	⊗				○	○	1,00	0,70	2,50	3,00	1,00	5,50	
	1124104	TNGM 220812-MP	TNGM 220812-MP	○	△	⊗				△	⊗	○			○	○	0,70	0,20	1,30	14,00	5,00	18,00	
	1124102	TNMM 441116-LH	TNMM 441116-LH	○				△	⊗			△	⊗		○	○	12,00	2,00	25,00	0,80	0,50	1,60	

⊗ First choice | 1ª Escolha | 1ª Opción

△ Stock available until sold out | Stock disponível até acabar o stock | Stock disponible hasta acabar el stock

Insert Order Code: (1) Geometry code + (2) Grade code

⊗ Stock items | Itens de stock

○ Available under request | Disponível sob consulta | Disponible bajo consulta

Dimensions Dimensões Dimensions (mm)									Technical Drawing Desenho Técnico Diseño Técnico
L	D	ln	B	S	d1	r	ap	K°	
38,25	-	22,00	17,50	12,00	-	-	4,00	20	
36,90	-	20,00	18,00	12,35	-	-	2,00	20	
36,30	-	20,00	18,00	12,45	-	-	2,00	20	
36,50	-	20,00	18,00	12,45	-	-	2,00	20	
36,90	-	27,00	18,00	12,45	-	-	2,00	20	
40,00	-	20,00	20,00	10,00	-	-	3,50	25	
40,00	-	20,00	20,00	12,00	-	-	3,50	25	
36,50	-	17,00	18,00	12,00	-	-	4,00	15	
-	28,60	20,00	-	10,00	7,00	-	2,50	20	
-	28,60	20,00	-	14,00	7,00	-	2,50	20	
-	19,05	22,00	-	8,00	7,96	-	1,20	15	
-	25,40	11,50	-	25,40	44,00	1,60	-	-	

BAR PEELING INSERTS RANGE

NEGATIVE INSERTS | PASTILHAS NEGATIVAS | PLAQUITAS NEGATIVAS

	(1) Geometry code	ISO Reference	ANSI Reference	new grades													Cutting conditions Condições de corte Condiciones de Corte					
				P					M					K			ap (mm)	Min	Max	fn (mm/r)	Min	Max
				L7	R2	L8	R3	N2	S9	L8	U5	N2	V7	P1	V8	L5						
PH5115	PHG115	PH5125	PHG125	PH5740	PHG140	PH5125	PHS225	PH5135	PHS235	PH5228	PHS228	PH5705	PH5320									
XNMJ-MP  Special 85°	1123835	XNMJ 151380-MP	XNMJ 151380-MP		○	△	△				△	△		△	△	○	3,00	1,00	6,50	6,00	4,00	12,00
XNMJ-MH  Special 85°	1123836	XNMJ 151380-MH	XNMJ 151380-MH		○	△	△				△	△		△	△	○	3,00	1,00	6,50	6,00	4,00	12,00
XNGF-FP  Special 85°	1123837	XNGF 150980-FP	XNGF 150980-FP		○		○				○			△	△	○	3,00	1,00	4,50	6,00	4,00	12,00
XNGJ-RP  Special 85°	1123834	XNGJ 151380-RP	XNGJ 151380-RP		○		○				○			△	△	○	3,00	1,00	6,50	6,00	4,00	12,00
WNGJ-MP  Special 75°	1124041	WNGJ 130950-MP	WNGJ 130950-MP		○	△	△				△	△		△	△	△	3,00	0,50	5,00	6,00	3,00	11,00
RNMX-MP  Round R°	1123831	RNMX 381200-MP	RNMX 381200-MP		○		△				○			△	△	○	4,00	2,00	8,00	2,00	1,00	4,00
	1123832	RNMX 5018M0-MP	RNMX 5018M0-MP		○		○				○			△	△	○	6,00	2,00	12,00	3,50	2,50	6,50
RNMX-RP  Round R°	1123833	RNMX 5018M0-RP	RNMX 5018M0-RP		○		○				○			△	△	○	6,00	2,00	12,00	6,00	4,00	10,50
RNMG-ST  Round R°	1120443	RNMG 250900-ST	RNMG 860-ST		△	△	△	△	△		△					△	5,00	2,50	10,00	1,00	0,25	2,50



△ First choice | 1ª Escolha | 1ª Opción

△ Stock available until sold out | Stock disponível até acabar o stock | Stock disponible hasta acabar el stock

Insert Order Code: (1) Geometry code + (2) Grade code

⊗ Stock items | Itens de stock

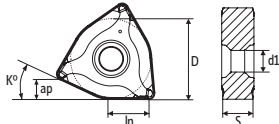
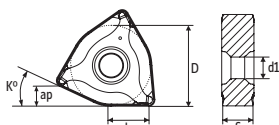
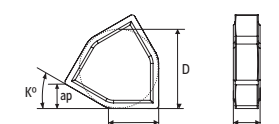
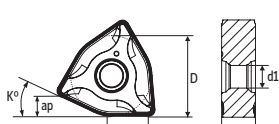
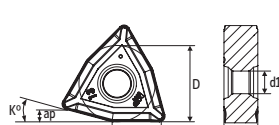
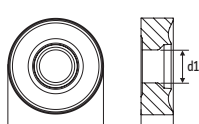
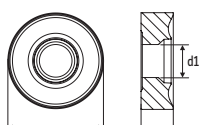
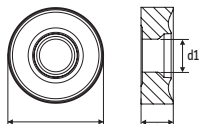
○ Available under request | Disponível sob consulta | Disponible bajo consulta

Dimensions Dimensões Dimensions (mm)									Technical Drawing Desenho Técnico Diseño Técnico
L	D	ln	B	S	d1	r	ap	K°	
-	31,75	15,00	-	13,00	9,00	-	8,00	25	
-	31,75	15,00	-	13,00	9,00	-	8,00	25	
-	28,58	15,00	-	8,88	-	-	8,00	30,00	
-	31,75	15,00	-	13,00	9,00	-	8,00	25	
-	22,23	13,00	-	9,56	7,93	-	5,00	15	
-	38,10	-	-	12,70	13,00	-	-	-	
-	50,00	-	-	18,00	12,70	-	-	-	
-	50,00	-	-	18,00	12,70	-	-	-	
-	25,40	-	-	9,52	9,12	-	-	-	



RAILWAY

RAILWAY

Palbit is constantly investing in new technologies, research and development of cutting tools for the railway industry.

We supply a complete range of tooling solutions based on a wide experience and know-how to achieve high efficiency machining on new rails and weels as well as re-profiling, crossing rails, joints and more.

FACE TURNING

Inserts with MT-CVD coating grade and high wear resistance for the machining of forged steels providing longer tool file.



WHEEL TURNING

Inserts with special design geometry for wheel re-profiling providing productivity through a better chip evacuation. High built-up edge resistance and wear providing efficiency and increasing tool life.

EXTERNAL TURNING

MT-CVD coating inserts with high wear resistance for turning long axle shafts.

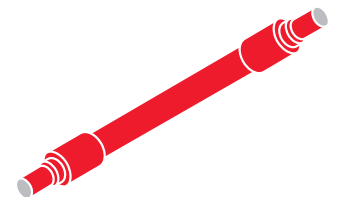



ISO RAILWAY INSERTS CODE KEY

H		M	
O		V	
P		W	
S		L	
T		A	
C		B	
D		K	
E		R	
F		X	Special

1- Insert shape symbol

Symbol	m (mm)	d (mm)	s (mm)
A	±0.005	±0.025	±0.025
F	±0.005	±0.013	±0.025
C	±0.013	±0.025	±0.025
H	±0.013	±0.013	±0.025
E	±0.025	±0.025	±0.025
G	±0.025	±0.025	±0.13
J	±0.005	±0.05~±0.13	±0.025
K*	±0.013	±0.05~±0.13	±0.025
L*	±0.025	±0.05~±0.13	±0.025
M*	±0.08~±0.20	±0.05~±0.13	±0.13
N*	±0.08~±0.20	±0.05~±0.13	±0.025
U*	±0.13~±0.38	±0.08~±0.25	±0.13

*As a rule, the sides of these inserts are as sintered. Tolerance differs with insert size, for the accuracy of class M, refer to the table on the right.

Triangular inserts with a facet (secondary cutting edge)

Detailed dimension of M class insert Insert height Tolerances (mm)					
Inscribed circle	T	S	C	D	V
6.35	±0.08	-	-	-	-
9.525	±0.08	±0.08	±0.11	±0.10	±0.13
12.70	±0.13	±0.13	±0.13	±0.15	-
15.875	±0.15	±0.15	±0.15	±0.18	-
19.05	±0.15	±0.15	±0.15	±0.18	-
25.40	-	±0.18	-	-	-
31.75	-	±0.25	-	-	-

Inscribed circle Tolerances (mm)					
Inscribed circle	T	S	C	D	V
6.35	±0.05	-	-	-	-
9.525	±0.05	±0.05	±0.05	±0.05	±0.05
12.70	±0.08	±0.08	±0.08	±0.08	±0.08
15.875	±0.10	±0.10	±0.10	±0.10	±0.10
19.05	-	-	-	-	±0.10
25.40	-	±0.13	-	-	±0.10
31.75	-	±0.20	-	-	±0.12

3 - Tolerances symbol

A	B	C	D	E
F	G	N	P	O
				Other clearance angle

2 - Normal clearance symbol

ISO	C	N	M	M
ANSI	C	N	M	M

4 - Insert symbol														
symbol	Type	Hole type	Chipbreaker	Shape	symbol	Type	Hole type	Chipbreaker	Shape	symbol	Type	Hole type	Chipbreaker	Shape
W	with hole	Round hole / one countersink (40°-60°)	Without chipbreaker		H	with hole	Round hole / one countersink (70°-90°)	Chipbreaker on one side		G	with hole	Round hole	Chipbreaker on both sides	
T			Chipbreaker on one side		C		Round hole / double countersink (70°-90°)	Without chipbreaker		N		-	Without chipbreaker	
Q		Round hole / double countersink (40°-60°)	Without chipbreaker		J			Chipbreaker on both sides		R	without hole	-	Chipbreaker on one side	
U			Chipbreaker on both sides		A		Without chipbreaker		F	-		Chipbreaker on both sides		
B		Round hole / one countersink (70°-90°)	Without chipbreaker		M		Round hole	Chipbreaker on one side		X	-	-	-	On request

R's	35° V's	55° D's	80° C's	90° S's	60° T's	80° W's	Ø CI		ANSI
							mm	inch	Symbol
-	06	04	-	03	06	02	3,97	5/32	1,20
-	08	05	04	04	08	L3	4,76	3/16	1,50
-	09	06	05	05	09	03	5,56	7/32	1,80
06**	-	-	-	-	-	-	6,00	0,236	
06*	11	07	06	06	11	04	6,35	1/4	2,00
07*	13	09	08	07	13	05	7,94	5/16	2,50
08*	-	-	-	-	-	-	8,00	0,315	
09*	16	11	09	09	16	06	9,525	3/8	3,00
10**	-	-	-	-	-	-	10,00	0,394	
12**	-	-	-	-	-	-	12,00	0,472	
12*	22	15	12	12	22	08	12,70	1/2	4,00
15*	27	19	16	15	27	10	15,875	5/8	5,00
16**	-	-	-	-	-	-	16,00	0,63	
19*	33	23	19	19	33	13	19,05	3/4	6,00
20**	-	-	-	-	-	-	20,00	0,787	
25**	-	-	-	-	-	-	25,00	0,984	
25*	44	31	25	25	44	17	25,40	1,00	8,00
31*	54	38	32	31	54	21	31,75	1 1/4	10,00
32**	-	-	-	-	-	-	32,00	1,26	

5 - Insert size symbol

* ANSI designation only
(Radius Designation is R0)

** Metric designation only
(Radius Designation is M0)

According to International Standard ISO 1832 - 2012(E)

"Indexable inserts for cutting tools - Designation"

ISO	mm	ANSI	inch
01	1.59	1	0.062
T1	1.98	1.2	0.078
02	2.38	1.5	0.094
03	3.18	2	0.125
T3	3.97	2.5	0.156
04	4.76	3	0.188
05	5.56	3.5	0.219
06	6.35	4	0.250
07	7.94	5	0.312
09	9.52	6	0.375
12	12.70	8	0.500

6 - Insert thickness symbol



10 - Chipbreaker geometries					
	HY	HZ	RMM	RRM	RHR
NEGATIVE Chipbreakers					
POSITIVE Chipbreakers	RM	RR	ST		

T	Tangential
*only when required.	

7 - Insert corner symbol			
ISO	mm	inch	ANSI
00	Sharp nose		0
01	0.10	.004	0.2
02	0.20	.008	0.5
04	0.40	.015	1
08	0.80	.032	2
12	1.2	.047	3
16	1.6	.062	4
20	2.0	.078	5
24	2.4	.094	6
28	2.8	.109	7
32	3.2	.125	8
00 (inch or M0/metric)	Round insert		0



7.1* - Insert edges symbol			
For inserts having secondary edges two digits are used:			
1 st digit is secondary edge		2 nd digit is secondary edges relief angle	
A	45°	A	3°
D	60°	B	5°
E	75°	C	7°
F	85°	D	15°
P	90°	E	20°
Z	special	F	25°
		G	30°
		N	0°
		P	11°
		Z	special
*only when required.			

8* - Cutting edge information		
Shape	Honing	Symbol
	No honing	F
	With honing	E
	Chamfered No honing	T
	Chamfered with honing	S
*only when required.		

9* - Cutting direction		
Shape	Hand	Symbol
	Right	R
	Left	L
	None	N
*only when required.		

CN = RHOMBIC 80° NEGATIVE



RÔMBICA 80° NEGATIVA | RÓMBICA 80° NEGATIVA

			P								M						K			N	S						
Inserts Pastilhas Plaquetas	(1) Geometry code	ISO Reference	CVD-MT								PVD		CVD-MT						PVD		CVD-MT			UNC	PVD		
			new grades										new grades														
			(2) Grade code	L6	T6	L7	R2	L8	R3	L9	V5	G1	G4	L7	U4	L8	U5	L9	V6	G1	G4	L5	L6	L9	10	G1	G4
 CNMM-HY Heavy to Roughing	1121608	CNMM 190612-HY			⊕	⊕	⊕	⊕	⊕			⊕		⊕		⊕	⊕										
	1121252	CNMM 190616-HY			⊕	⊕	⊕	⊕	⊕			⊕		⊕		⊕	⊕										
	1121434	CNMM 190624-HY			⊕	⊕	⊕	⊕	⊕			⊕		⊕		⊕	⊕										
	1121248	CNMM 250924-HY			⊕	⊕	⊕	⊕	⊕			⊕		⊕		⊕	⊕										
 CNMM-HZ Heavy to Roughing	1121607	CNMM 190612-HZ			⊕	⊕	⊕	⊕	⊕												⊕	⊕					
	1121251	CNMM 190616-HZ			⊕	⊕	⊕	⊕	⊕													⊕	⊕				
	1121435	CNMM 190624-HZ			⊕	⊕	⊕	⊕	⊕													⊕	⊕				
	1121247	CNMM 250924-HZ			⊕	⊕	⊕	⊕	⊕													⊕	⊕				

⊕ First choice | 1ª Escolha | 1ª Opción
 ⊕ Stock available until sold out | Stock disponível até acabar o stock | Stock disponible hasta acabar el stock
 Insert Order Code: ⁽¹⁾ Geometry code + ⁽²⁾ Grade code
⊕ Stock Items | Itens de stock
 ○ Available under request | Disponível sob consulta | Disponible bajo consulta

SN = SQUARE 90° NEGATIVE

QUADRADA 90° NEGATIVA | ESQUADRA 90° NEGATIVA

			P								M						K			N	S						
Inserts Pastilhas Plaquetas	(1) Geometry code	ISO Reference	CVD-MT								PVD		CVD-MT						PVD		CVD-MT			UNC	PVD		
			new grades										new grades														
			(2) Grade code	L6	T6	L7	R2	L8	R3	L9	V5	G1	G4	L7	U4	L8	U5	L9	V6	G1	G4	L5	L6	L9	10	G1	G4
 SNMM-HY Heavy to Roughing	1121606	SNMM 190612-HY			⊕	⊕	⊕	⊕	⊕			⊕		⊕		⊕	⊕										
	1121250	SNMM 190616-HY			⊕	⊕	⊕	⊕	⊕			⊕		⊕		⊕	⊕										
	1121452	SNMM 190624-HY			⊕	⊕	⊕	⊕	⊕			⊕		⊕		⊕	⊕										
	1121160	SNMM 250724-HY			⊕	⊕	⊕	⊕	⊕			⊕		⊕		⊕	⊕										
 SNMM-HZ Heavy to Roughing	1121161	SNMM 250924-HY			⊕	⊕	⊕	⊕	⊕			⊕		⊕		⊕	⊕										
	1121605	SNMM 190612-HZ			⊕	⊕	⊕	⊕	⊕													⊕	⊕				
	1121249	SNMM 190616-HZ			⊕	⊕	⊕	⊕	⊕													⊕	⊕				
	1121440	SNMM 190624-HZ			⊕	⊕	⊕	⊕	⊕													⊕	⊕				
	1121158	SNMM 250724-HZ			⊕	⊕	⊕	⊕	⊕													⊕	⊕				
	1123786	SNMM 250732-HZ						⊕	⊕													⊕	⊕				
1121159	SNMM 250924-HZ			⊕	⊕	⊕	⊕	⊕													⊕	⊕					

⊕ First choice | 1ª Escolha | 1ª Opción
 ⊕ Stock available until sold out | Stock disponível até acabar o stock | Stock disponible hasta acabar el stock
 Insert Order Code: ⁽¹⁾ Geometry code + ⁽²⁾ Grade code
⊕ Stock Items | Itens de stock
 ○ Available under request | Disponível sob consulta | Disponible bajo consulta

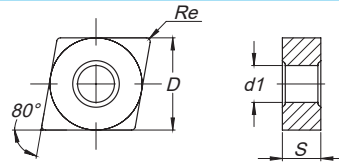

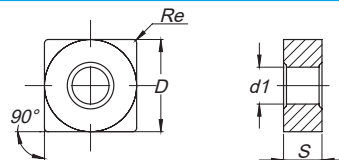

ISO Reference	ANSI Reference	Dimensions (mm) Dimensões (mm) Dimensiones (mm)				Cutting Conditions Condições de Corte Condiciones de Corte					
		D	S	Re	d1	ap (mm)	Min	Max	fn (mm/rev)	Min	Max
CNMM 190612-HY	CNMM 643-HY	19,050	6,35	1,20	7,94	6,00	2,00	12,00	0,50	0,35	0,80
CNMM 190616-HY	CNMM 644-HY	19,050	6,35	1,60	7,94	6,00	2,00	12,00	0,60	0,35	1,00
CNMM 190624-HY	CNMM 646-HY	19,050	6,35	2,40	7,94	6,00	2,00	12,00	0,60	0,35	1,20
CNMM 250924-HY	CNMM 866-HY	25,400	9,52	2,40	9,12	8,00	2,50	15,00	0,70	0,40	1,40
CNMM 190612-HZ	CNMM 643-HZ	19,050	6,35	1,20	7,94	10,00	2,40	12,00	0,65	0,50	0,80
CNMM 190616-HZ	CNMM 644-HZ	19,050	6,35	1,60	7,94	10,00	2,40	12,00	0,80	0,50	1,10
CNMM 190624-HZ	CNMM 646-HZ	19,050	6,35	2,40	7,94	10,00	3,20	12,00	1,00	0,60	1,60
CNMM 250924-HZ	CNMM 866-HZ	25,400	9,52	2,40	9,12	10,00	3,20	17,00	1,00	0,60	1,60



ISO Reference	ANSI Reference	Dimensions (mm) Dimensões (mm) Dimensiones (mm)				Cutting Conditions Condições de Corte Condiciones de Corte					
		D	S	Re	d1	ap (mm)	Min	Max	fn (mm/rev)	Min	Max
SNMM 190612-HY	SNMM 643-HY	19,050	6,35	1,20	7,94	6,00	2,00	12,00	0,60	0,35	0,90
SNMM 190616-HY	SNMM 644-HY	19,050	6,35	1,60	7,94	6,00	2,00	12,00	0,60	0,35	1,20
SNMM 190624-HY	SNMM 646-HY	19,050	6,35	2,40	7,94	6,00	2,00	12,00	1,00	0,60	1,60
SNMM 250724-HY	SNMM 856-HY	25,400	7,94	2,40	9,12	8,50	2,50	15,00	1,00	0,60	1,60
SNMM 250924-HY	SNMM 866-HY	25,400	9,52	2,40	9,12	8,50	3,00	15,00	1,00	0,60	1,60
SNMM 190612-HZ	SNMM 643-HZ	19,050	6,35	1,20	7,94	10,00	2,40	13,00	0,60	0,35	0,90
SNMM 190616-HZ	SNMM 644-HZ	19,050	6,35	1,60	7,94	10,00	2,40	13,00	0,60	0,35	1,20
SNMM 190624-HZ	SNMM 646-HZ	19,050	6,35	2,40	7,94	10,00	3,20	13,00	1,00	0,60	1,60
SNMM 250724-HZ	SNMM 856-HZ	25,400	7,94	2,40	9,12	10,00	3,20	17,00	1,00	0,60	1,60
SNMM 250732-HZ	SNMM 858-HZ	25,400	7,94	3,20	9,12	10,00	3,20	17,00	1,20	0,80	1,80
SNMM 250924-HZ	SNMM 866-HZ	25,400	9,52	2,40	9,12	10,00	3,20	17,00	1,00	0,60	1,60

LINUX = RECTANGULAR 90° NEGATIVE

RECTANGULAR 90° NEGATIVA | RETANGULAR 90° NEGATIVA

Inserts Pastilhas Plaquetas	(1) Geometry code	new grades (2) Grade code ISO Reference	P						M						K						
			CVD-MT						PVD		CVD-MT						PVD		UNC	CVD-MT	
			L7	R2	L8	R3	L9	V5	G1	G4	L7	U4	L8	U5	L9	V6	G1	G4	25	L5	L6
LNIX-RMM  Medium	1123640	LNIX 321248-RMM	△	⊗	△	⊗															
LNIX-RRM  Roughing	1123639	LNIX 321248-RRM	△	⊗		○		○													○
LNIX-RHR  Heavy Roughing	1123643	LNIX 321248-RHR	△	⊗		○															

⊗ First choice | 1ª Escolha | 1ª Opción
 △ Stock items | Itens de stock

△ Stock available until sold out | Stock disponível até acabar o stock | Stock disponible hasta acabar el stock
 ○ Available under request | Disponível sob consulta | Disponible bajo consulta

Insert Order Code: (1) Geometry code + (2) Grade code

LINUX-T = TANGENTIAL 90° NEGATIVE

TANGENCIAL 90° NEGATIVA | TANGENCIAL 90° NEGATIVA

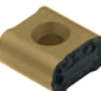
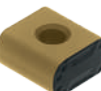
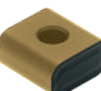
Inserts Pastilhas Plaquetas	(1) Geometry code	new grades (2) Grade code ISO Reference	P						M						K						
			CVD-MT						PVD		CVD-MT						PVD		UNC	CVD-MT	
			L7	R2	L8	R3	L9	V5	G1	G4	L7	U4	L8	U5	L9	V6	G1	G4	25	L5	L6
LNIX-RMM-T  Medium	1121953	LNIX 191940-RMM-T	△	⊗	△	⊗															
	1122005	LNIX 301940-RMM-T	△	⊗	△	⊗															
LNIX-RRM-T  Roughing	1120404	LNIX 191940-RRM-T	△	⊗	△	⊗															
	1123985	LNIX 301940-RRM-T	△	⊗	△	⊗															
LNIX-RHR-T  Heavy Roughing	1191628	LNIX 191940-RHR-T	△	⊗	△	⊗															
	1191969	LNIX 301940-RHR-T	△	⊗	△	⊗															

⊗ First choice | 1ª Escolha | 1ª Opción
 △ Stock items | Itens de stock

△ Stock available until sold out | Stock disponível até acabar o stock | Stock disponible hasta acabar el stock
 ○ Available under request | Disponível sob consulta | Disponible bajo consulta

Insert Order Code: (1) Geometry code + (2) Grade code

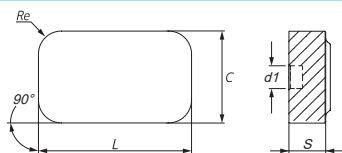

ISO Reference	ANSI Reference	Dimensions (mm) Dimensões (mm) Dimensiones (mm)					Cutting Conditions Condições de Corte Condiciones de Corte					
		L	C	Re	S	d1	ap (mm)	Min	Max	fn (mm/rev)	Min	Max
LNUX 321248-RMM	LNUX 321248-RMM	31,75	19,05	4,76	12,7	7,87	3,00	1,50	18,00	0,80	0,30	1,50
LNUX 321248-RRM	LNUX 321248-RRM	31,75	19,05	4,76	12,7	7,87	3,00	1,50	18,00	1,00	0,80	1,50
LNUX 321248-RHR	LNUX 321248-RHR	31,75	19,05	4,76	12,7	7,87	3,00	1,50	18,00	1,20	0,50	1,80

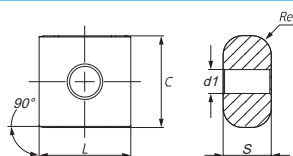





ISO Reference	ANSI Reference	Dimensions (mm) Dimensões (mm) Dimensiones (mm)					Cutting Conditions Condições de Corte Condiciones de Corte					
		L	C	Re	S	d1	ap (mm)	Min	Max	fn (mm/rev)	Min	Max
LNUX 191940-RMM-T	LNUX 191940-RMM-T	19,05	19,05	4,00	10,00	6,35	2,50	1,60	8,00	0,80	0,30	1,50
LNUX 301940-RMM-T	LNUX 301940-RMM-T	30,00	19,05	4,00	12,00	6,35	3,00	1,60	12,00	0,80	0,30	1,50
LNUX 191940-RRM-T	LNUX 191940-RRM-T	19,05	19,05	4,00	10,00	6,35	5,50	2,50	10,00	1,00	0,80	1,50
LNUX 301940-RRM-T	LNUX 301940-RRM-T	30,00	19,05	4,00	12,00	6,35	4,50	2,50	13,00	1,00	0,50	2,00
LNUX 191940-RHR-T	LNUX 191940-RHR-T	19,05	19,05	4,00	10,00	6,35	5,50	2,50	10,00	1,20	0,50	1,80
LNUX 301940-RHR-T	LNUX 301940-RHR-T	30,00	19,05	4,00	12,00	6,35	6,50	3,00	15,00	1,20	0,50	1,80

RC = ROUND R° POSITIVE



REDONDA R° POSITIVA | REDONDA R° POSITIVA





Inserts Pastilhas Plaquitas	(1) Geometry code	new grades (2) Grade code ISO Reference	P								M						K			N		S												
			CVD-MT				PVD				CVD-MT						PVD		UNC	CVD-MT		UNC	PVD											
			L7	R2	L8	R3	L9	V5	G1	G4	L7	U4	L8	U5	L9	V6	G1	G4	25	L5	L6	L9	10	G1	G4									
			PH5115	PHG115	PH5125	PHG125	PH5740	PHG140	PH7910	PH7920	PH5115	PHS215	PH5125	PHS225	PH5740	PHS240	PH7910	PH7920	PH0705	PH5705	PH5320	PH5740	PH0910	PH7910	PH7920									
	1122009	RCMR 2507M0-RR																																
	1122008	RCMR 3209M0-RR																																
Roughing to Medium																																		

 First choice | 1ª Escolha | 1ª Opción
  Stock available until sold out | Stock disponível até acabar o stock | Stock disponible hasta acabar el stock
 Insert Order Code: (1) Geometry code + (2) Grade code
 Stock Items | Itens de stock
  Available under request | Disponível sob consulta | Disponible bajo consulta

RC = ROUND R° POSITIVE

REDONDA R° POSITIVA | REDONDA R° POSITIVA

Inserts Pastilhas Plaquitas	(1) Geometry code	new grades (2) Grade code ISO Reference	P								M						K			N		S											
			CVD-MT				PVD				CVD-MT						PVD		UNC	CVD-MT		UNC	PVD										
			L7	R2	L8	R3	L9	V5	G1	G4	L7	U4	L8	U5	L9	V6	G1	G4	25	L5	L6	L9	10	G1	G4								
			PH5115	PHG115	PH5125	PHG125	PH5740	PHG140	PH7910	PH7920	PH5115	PHS215	PH5125	PHS225	PH5740	PHS240	PH7910	PH7920	PH0705	PH5705	PH5320	PH5740	PH0910	PH7910	PH7920								
	1121428	RCMX 2006M0-ST																															
	1121429	RCMX 2507M0-ST																															
	1123910	RCMX 3009M0-ST																															
	1121430	RCMX 3209M0-ST																															
	1123678	RCMX 3209M0-RM																															
	Roughing to Medium																																
	1123667	RCMX 2507M0-RR																															
	1123666	RCMX 3209M0-RR																															
Roughing to Medium																																	

 First choice | 1ª Escolha | 1ª Opción
  Stock available until sold out | Stock disponível até acabar o stock | Stock disponible hasta acabar el stock
 Insert Order Code: (1) Geometry code + (2) Grade code
 Stock Items | Itens de stock
  Available under request | Disponível sob consulta | Disponible bajo consulta

RELIEF ANGLE 7°

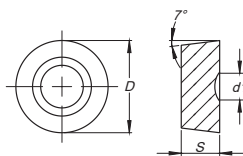

ISO Reference	ANSI Reference	Dimensions (mm) Dimensões (mm) Dimensiones (mm)				Cutting Conditions Condições de Corte Condiciones de Corte					
		D	S	Re	d1	ap (mm)	Min	Max	fn (mm/rev)	Min	Max
RCMR 2507M0-RR	RCMR 2507M0-RR	25,00	7,94	-	9,00	5,00	3,20	8,00	1,80	0,80	2,50
RCMR 3209M0-RR	RCMR 3209M0-RR	32,00	9,52	-	12,00	6,50	3,20	13,00	1,80	0,80	2,50

RELIEF ANGLE 7°

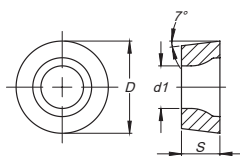

ISO Reference	ANSI Reference	Dimensions (mm) Dimensões (mm) Dimensiones (mm)				Cutting Conditions Condições de Corte Condiciones de Corte					
		D	S	Re	d1	ap (mm)	Min	Max	fn (mm/rev)	Min	Max
RCMX 2006M0-ST	RCMX 2006M0-ST	20,00	6,35	-	6,50	5,00	2,00	8,00	0,63	0,20	2,00
RCMX 2507M0-ST	RCMX 2507M0-ST	25,00	7,94	-	7,20	6,30	2,50	10,00	0,79	0,25	2,50
RCMX 3009M0-ST	RCMX 3009M0-ST	30,00	9,55	-	10,00	7,00	3,00	11,00	0,85	0,30	2,80
RCMX 3209M0-ST	RCMX 3209M0-ST	32,00	9,52	-	9,50	8,00	3,20	12,80	1,01	0,32	3,20
RCMX 3209M0-RM	RCMX 3209M0-RM	32,00	9,52	-	9,50	6,50	3,20	13,00	1,80	0,80	2,50
RCMX 2507M0-RR	RCMX 2507M0-RR	25,00	7,94	-	7,20	5,00	3,20	8,00	1,80	0,80	2,50
RCMX 3209M0-RR	RCMX 3209M0-RR	32,00	9,52	-	9,50	6,50	3,20	13,00	1,80	0,80	2,50

SCARFING = SNMA

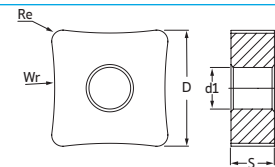

Inserts Pastilhas Plaquitas	(1) Geometry code	(2) Grade code		P	M	Dimensions (mm) Dimensões (mm) Dimensiones (mm)					Tube Diameter (mm)
				CVD	CVD	D	S	Re	d1	Wr	
				L8	L8						
				PH5125	PH5125						
	1123927	SNMA 150612-R020	SNMA 543-R020	○	○	15,88	6,35	1,2	6,35	20	23-29
	1123928	SNMA 150612-R022	SNMA 543-R022	○	○	15,88	6,35	1,2	6,35	22	25-32
	1123929	SNMA 150612-R025	SNMA 543-R025	○	○	15,88	6,35	1,2	6,35	25	29-36
	1123930	SNMA 150612-R027	SNMA 543-R027	○	○	15,88	6,35	1,2	6,35	27	31-39
	1123931	SNMA 150612-R030	SNMA 543-R030	○	○	15,88	6,35	1,2	6,35	30	35-44
	1123932	SNMA 150612-R035	SNMA 543-R035	○	○	15,88	6,35	1,2	6,35	35	40-51
	1123933	SNMA 150612-R040	SNMA 543-R040	○	○	15,88	6,35	1,2	6,35	40	46-58
	1123934	SNMA 150612-R050	SNMA 543-R050	○	○	15,88	6,35	1,2	6,35	50	58-73
	1123935	SNMA 150612-R060	SNMA 543-R060	○	○	15,88	6,35	1,2	6,35	60	69-87
	1123936	SNMA 150612-R070	SNMA 543-R070	○	○	15,88	6,35	1,2	6,35	70	80-95
	1123937	SNMA 190612-R030	SNMA 643-R030	○	○	19,05	6,35	1,2	7,94	30	35-44
	1123938	SNMA 190612-R040	SNMA 643-R040	○	○	19,05	6,35	1,2	7,94	40	46-58
	1123939	SNMA 190612-R050	SNMA 643-R050	○	○	19,05	6,35	1,2	7,94	50	58-73
	1123940	SNMA 190612-R060	SNMA 643-R060	○	○	19,05	6,35	1,2	7,94	60	69-87
	1123941	SNMA 190612-R070	SNMA 643-R070	○	○	19,05	6,35	1,2	7,94	70	80-95
	1123942	SNMA 190612-R080	SNMA 643-R080	○	○	19,05	6,35	1,2	7,94	80	92-116
	1123943	SNMA 190612-R090	SNMA 643-R090	○	○	19,05	6,35	1,2	7,94	90	104-131
	1123944	SNMA 250924-R000	SNMA 866-R000	○	○	25,40	9,52	2,4	9,12	0	-
	1123945	SNMA 250924-R060	SNMA 866-R060	○	○	25,40	9,52	2,4	9,12	60	69-87
	1123946	SNMA 250924-R070	SNMA 866-R070	○	○	25,40	9,52	2,4	9,12	70	80-95
	1123947	SNMA 250924-R080	SNMA 866-R080	○	○	25,40	9,52	2,4	9,12	80	92-116
	1123948	SNMA 250924-R100	SNMA 866-R100	○	○	25,40	9,52	2,4	9,12	100	115-145
	1123949	SNMA 250924-R150	SNMA 866-R150	○	○	25,40	9,52	2,4	9,12	150	165-215
	1123950	SNMA 250924-R200	SNMA 866-R200	○	○	25,40	9,52	2,4	9,12	200	230-290

SNMA



Roughing

First choice | 1ª Escolha | 1ª Opción

Stock Items | Itens de stock

Available under request | Disponível sob consulta | Disponible bajo consulta

Insert Order Code: (1) Geometry code + (2) Grade code

SCARFING = SNMX

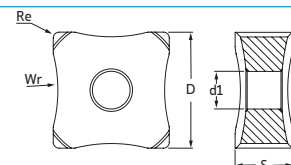

Inserts Pastilhas Plaquetas	(1) Geometry code	(2) Grade code		P	M	Dimensions (mm) Dimensões (mm) Dimensiones (mm)					Tube Diameter (mm)
		ISO Reference	ANSI Reference	CVD	CVD	D	S	Re	d1	Wr	
				L8	L8						
				PH5125	PH5125						
	1123879	SNMX 150708-R000	SNMX 552-R000	○	○	15,88	7,94	0,8	5,16	0	-
	1123880	SNMX 150708-R007	SNMX 552-R007	○	○	15,88	7,94	0,8	5,16	7	08-10
	1123881	SNMX 150708-R009	SNMX 552-R009	○	○	15,88	7,94	0,8	5,16	9	10-13
	1123882	SNMX 150708-R011	SNMX 552-R011	○	○	15,88	7,94	0,8	5,16	11	13-16
	1123883	SNMX 150708-R013	SNMX 552-R013	○	○	15,88	7,94	0,8	5,16	13	15-19
	1123884	SNMX 150708-R015	SNMX 552-R015	○	○	15,88	7,94	0,8	5,16	15	17-22
	1123885	SNMX 150708-R018	SNMX 552-R018	○	○	15,88	7,94	0,8	5,16	18	21-26
	1123886	SNMX 150708-R020	SNMX 552-R020	⊗	⊗	15,88	7,94	0,8	5,16	20	23-29
	1123887	SNMX 150708-R022	SNMX 552-R022	○	○	15,88	7,94	0,8	5,16	22	25-32
	1123888	SNMX 150708-R025	SNMX 552-R025	○	○	15,88	7,94	0,8	5,16	25	29-36
	1123889	SNMX 150708-R027	SNMX 552-R027	○	○	15,88	7,94	0,8	5,16	27	31-39
	1123890	SNMX 150708-R030	SNMX 552-R030	○	○	15,88	7,94	0,8	5,16	30	35-44
	1123891	SNMX 150708-R035	SNMX 552-R035	○	○	15,88	7,94	0,8	5,16	35	40-51
	1123892	SNMX 150708-R040	SNMX 552-R040	○	○	15,88	7,94	0,8	5,16	40	46-58
	1123893	SNMX 150708-R045	SNMX 552-R045	○	○	15,88	7,94	0,8	5,16	45	52-65
	1123894	SNMX 150708-R050	SNMX 552-R050	○	○	15,88	7,94	0,8	5,16	50	58-73
	1123895	SNMX 150708-R060	SNMX 552-R060	○	○	15,88	7,94	0,8	5,16	60	69-87
	1124461	SNMX 150708-R070	SNMX 552-R070	○	○	15,88	7,94	0,8	5,16	70	80-95
	1124462	SNMX 150708-R075	SNMX 552-R075	○	○	15,88	7,94	0,8	5,16	75	86-102
	1123896	SNMX 190912-R000	SNMX 663-R000	○	○	19,05	9,12	1,2	6,35	0	-
	1122012	SNMX 190912-R020	SNMX 663-R020	○	○	19,05	9,12	1,2	6,35	20	23-29
	1123897	SNMX 190912-R030	SNMX 663-R030	○	○	19,05	9,12	1,2	6,35	30	35-44
	1123898	SNMX 190912-R040	SNMX 663-R040	○	○	19,05	9,12	1,2	6,35	40	46-58
	1123899	SNMX 190912-R050	SNMX 663-R050	○	○	19,05	9,12	1,2	6,35	50	58-73
	1122013	SNMX 190912-R060	SNMX 663-R060	○	○	19,05	9,12	1,2	6,35	60	69-87
	1123900	SNMX 190912-R070	SNMX 663-R070	○	○	19,05	9,12	1,2	6,35	70	80-95
	1123901	SNMX 190912-R080	SNMX 663-R080	○	○	19,05	9,12	1,2	6,35	80	92-116
	1123902	SNMX 190912-R090	SNMX 663-R090	○	○	19,05	9,12	1,2	6,35	90	104-131
	1123903	SNMX 190912-R100	SNMX 663-R100	○	○	19,05	9,12	1,2	6,35	100	115-145
	1123864	SNMX 251216-R000	SNMX 884-R000	⊗	⊗	25,40	12,70	1,6	9,12	0	-
	1123904	SNMX 251216-R050	SNMX 884-R050	⊗	⊗	25,40	12,70	1,6	9,12	50	58-73
	1122015	SNMX 251216-R080	SNMX 884-R080	⊗	⊗	25,40	12,70	1,6	9,12	80	92-116
	1123905	SNMX 251216-R090	SNMX 884-R090	⊗	⊗	25,40	12,70	1,6	9,12	90	104-131
	1123906	SNMX 251216-R100	SNMX 884-R100	⊗	⊗	25,40	12,70	1,6	9,12	100	115-145
	1122016	SNMX 251216-R120	SNMX 884-R120	⊗	⊗	25,40	12,70	1,6	9,12	120	138-174
	1123907	SNMX 251216-R150	SNMX 884-R150	⊗	⊗	25,40	12,70	1,6	9,12	150	165-215
	1123908	SNMX 251216-R200	SNMX 884-R200	⊗	⊗	25,40	12,70	1,6	9,12	200	230-290
	1123909	SNMX 251216-R250	SNMX 884-R250	⊗	⊗	25,40	12,70	1,6	9,12	250	275-315



First choice | 1ª Escolha | 1ª Opción

Stock items | Itens de stock

Available under request | Disponível sob consulta | Disponible bajo consulta

Insert Order Code: (1) Geometry code + (2) Grade code

SCARFING = SNMG

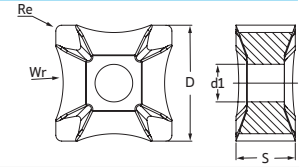

Inserts Pastilhas Plaquetas	(1) Geometry code	ISO Reference	ANSI Reference	P	M	Dimensions (mm) Dimensões (mm) Dimensiones (mm)					Tube Diameter (mm)
				CVD	CVD	D	S	Re	d1	Wr	
				L7	L8						
(2) Grade code				PH5115	PH5125						
	1123951	SNMG 15M808-R000	SNMG 55.12-R000	○	○	15,88	8,15	0,8	5,16	0	-
	1123952	SNMG 15M808-R007	SNMG 55.12-R007	○	○	15,88	8,15	0,8	5,16	7	08-10
	1123953	SNMG 15M808-R009	SNMG 55.12-R009	○	○	15,88	8,15	0,8	5,16	9	10-13
	1123954	SNMG 15M808-R011	SNMG 55.12-R011	⊗	○	15,88	8,15	0,8	5,16	11	13-16
	1123955	SNMG 15M808-R013	SNMG 55.12-R013	⊗	○	15,88	8,15	0,8	5,16	13	15-19
	1123956	SNMG 15M808-R015	SNMG 55.12-R015	⊗	○	15,88	8,15	0,8	5,16	15	17-22
	1123957	SNMG 15M808-R018	SNMG 55.12-R018	⊗	○	15,88	8,15	0,8	5,16	18	21-26
	1123958	SNMG 15M808-R020	SNMG 55.12-R020	⊗	○	15,88	8,15	0,8	5,16	20	23-29
	1123959	SNMG 15M808-R022	SNMG 55.12-R022	○	○	15,88	8,15	0,8	5,16	22	25-32
	1123960	SNMG 15M808-R025	SNMG 55.12-R025	⊗	○	15,88	8,15	0,8	5,16	25	29-36
	1123961	SNMG 15M808-R027	SNMG 55.12-R027	⊗	○	15,88	8,15	0,8	5,16	27	31-39
	1123962	SNMG 15M808-R030	SNMG 55.12-R030	⊗	○	15,88	8,15	0,8	5,16	30	35-44
	1123963	SNMG 15M808-R035	SNMG 55.12-R035	⊗	○	15,88	8,15	0,8	5,16	35	40-51
	1123964	SNMG 15M808-R040	SNMG 55.12-R040	⊗	○	15,88	8,15	0,8	5,16	40	46-58
	1123965	SNMG 15M808-R045	SNMG 55.12-R045	⊗	○	15,88	8,15	0,8	5,16	45	52-65
	1123966	SNMG 15M808-R050	SNMG 55.12-R050	○	○	15,88	8,15	0,8	5,16	50	58-73
	1123967	SNMG 15M808-R060	SNMG 55.12-R060	⊗	○	15,88	8,15	0,8	5,16	60	69-87
	1123968	SNMG 19M808-R000	SNMG 65.13-R000	○	○	19,05	8,15	0,8	8,00	20	-
	1123969	SNMG 19M808-R010	SNMG 65.13-R010	○	○	19,05	8,15	0,8	8,00	10	12-15
	1123970	SNMG 19M808-R020	SNMG 65.13-R020	⊗	○	19,05	8,15	0,8	8,00	20	23-29
	1123971	SNMG 19M808-R030	SNMG 65.13-R030	⊗	○	19,05	8,15	0,8	8,00	30	35-44
	1123972	SNMG 19M808-R040	SNMG 65.13-R040	○	○	19,05	8,15	0,8	8,00	40	46-58
	1123973	SNMG 19M808-R050	SNMG 65.13-R050	○	○	19,05	8,15	0,8	8,00	50	58-73
	1123974	SNMG 19M808-R060	SNMG 65.13-R060	○	○	19,05	8,15	0,8	8,00	60	69-87
	1123975	SNMG 19M808-R070	SNMG 65.13-R070	○	○	19,05	8,15	0,8	8,00	70	80-95
	1123976	SNMG 19M808-R080	SNMG 65.13-R080	○	○	19,05	8,15	0,8	8,00	80	92-116
	1123977	SNMG 19M808-R090	SNMG 65.13-R090	○	○	19,05	8,15	0,8	8,00	90	104-131
	1123978	SNMG 19M808-R100	SNMG 65.13-R100	○	○	19,05	8,15	0,8	8,00	100	115-145



⊗ First choice | 1ª Escolha | 1ª Opción
 ⊗ Stock items | Itens de stock
 ○ Available under request | Disponível sob consulta | Disponible bajo consulta
 Insert Order Code: ⁽¹⁾ Geometry code + ⁽²⁾ Grade code

ANYTIME, ANYWHERE

Online ordering available 24-hour per day and shipments around the globe.



WWW.CLIENTS.PALBIT.PT

CODE KEY FOR EXTERNAL TURNING TOOLHOLDERS

Sistema De Codificação Para Suportes De Torneamento Externo (ISO) | Codificación De Herramientas De Torneado Exterior (ISO)

P	C	L	N	R	25	25	M	12
1	2	3	4	5	6	7	8	9

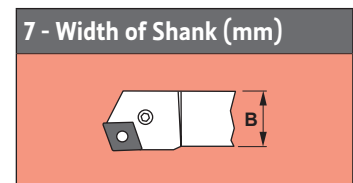
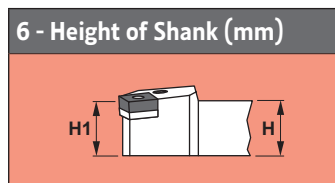
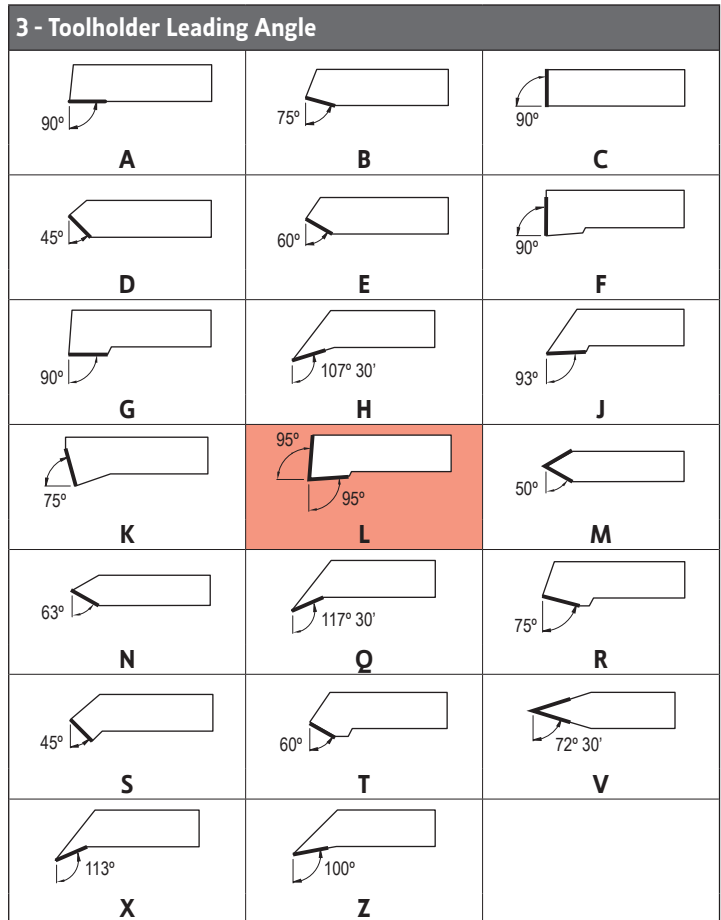
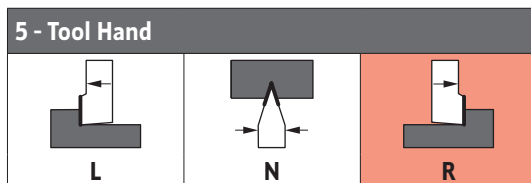
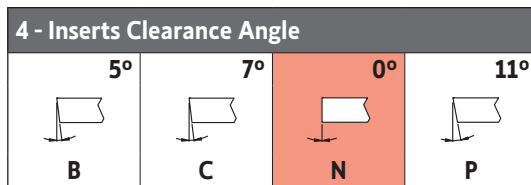
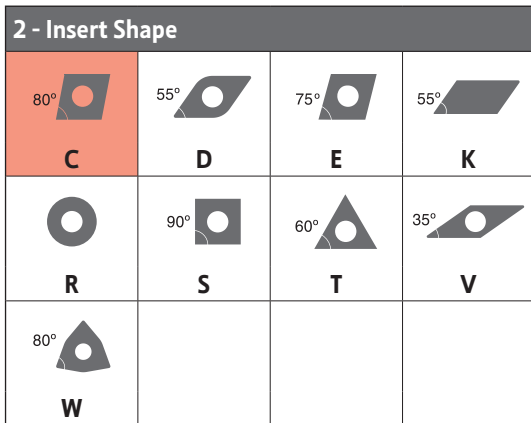
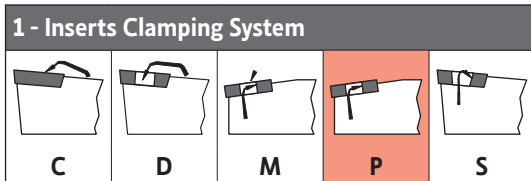

8 - Length of Holder (mm)

	D	60	P	170
	E	70	R	200
	F	80	S	250
	G	90	T	300
	H	100	U	350
	K	125	V	400
	L	140	X	Special
	M	150		

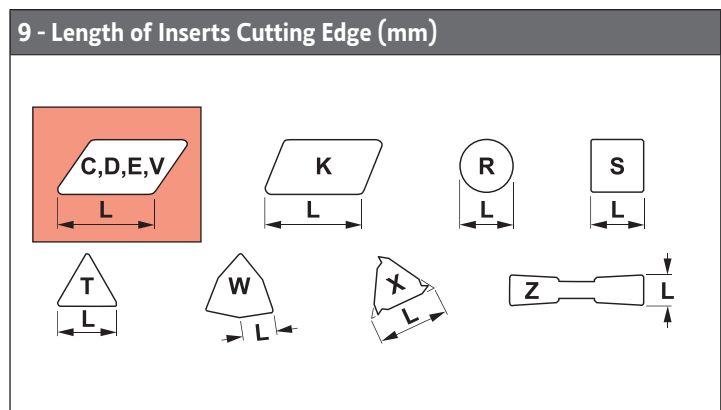



- C - 526 | Top Clamp Toolholders (C)
- C - 541 | Dimple Lock Toolholders (D)
- C - 547 | Wedge Clamp (M) & Double Lock (M-K) Toolholders
- C - 562 | Lever Lock Toolholders (P)
- C - 585 | Center Screw Toolholders (S)

EXTERNAL TURNING



TURNING

Insert selection

Overview

Negative inserts

Positive inserts

PCBN & PCD inserts

Heavy turning

External Toolholders

Internal Toolholders

Automatic Lathes

Spare Parts

Technical Data

CLAMPING SYSTEMS FOR EXTERNAL TOOLHOLDERS

Sistemas De Fixação Para Ferramentas De Torneamento Externo | Sistemas De Fijación Para Herramientas De Torneado Exterior

(C) TOP CLAMP SYSTEM

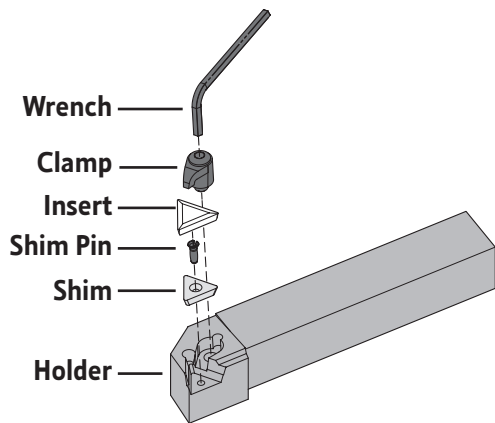

(D) DIMPLE LOCK SYSTEM

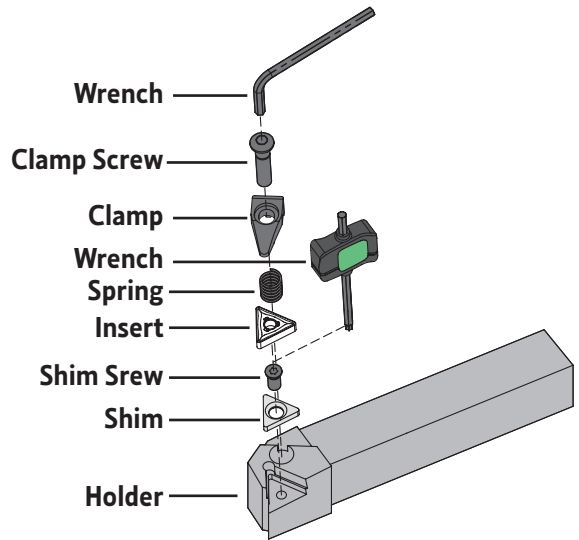

(M) WEDGE CLAMP SYSTEM

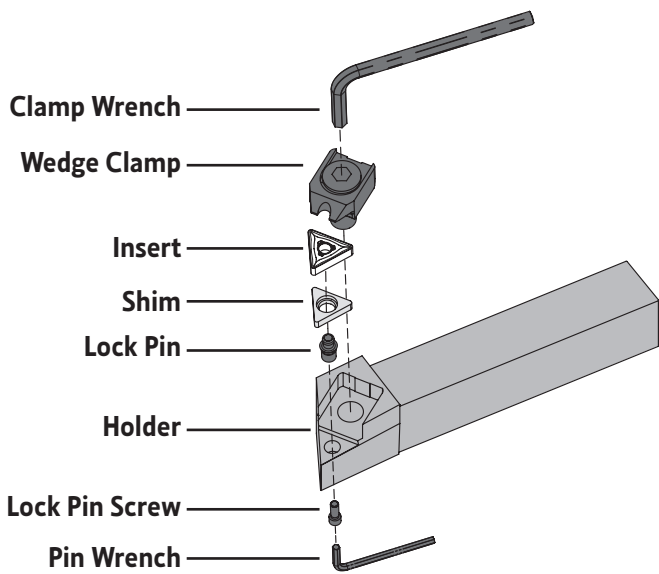

(M-K) DOUBLE LOCK SYSTEM

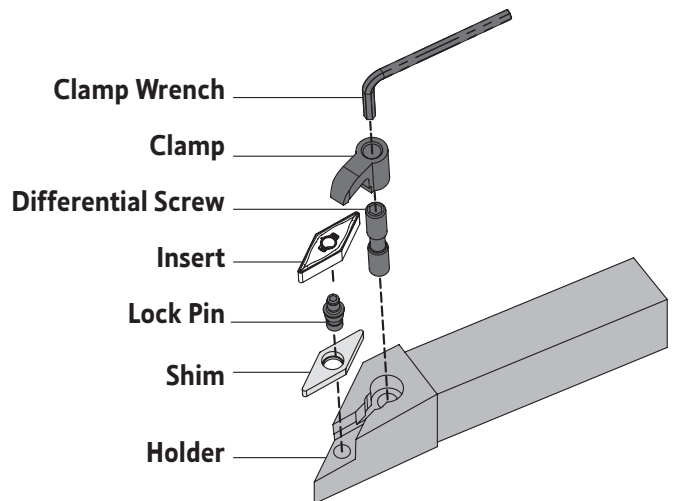

(P) LEVER LOCK SYSTEM

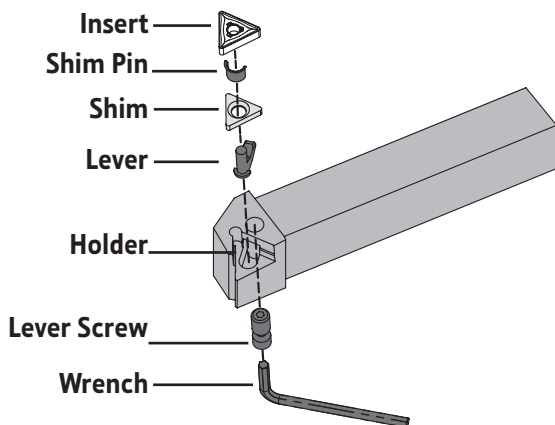

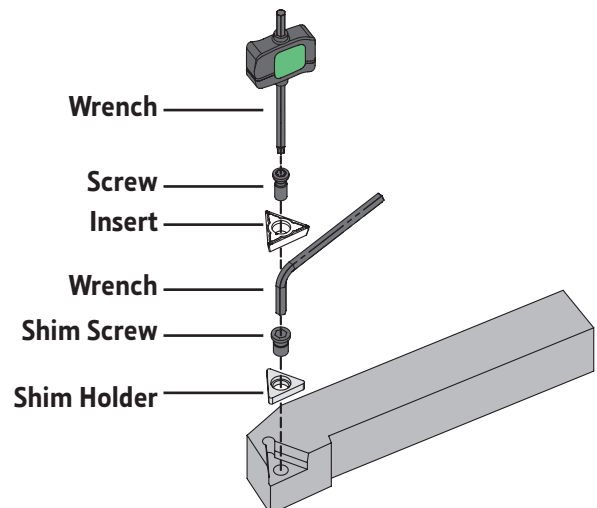

(S) CENTER SCREW SYSTEM



TURNING
 Insert selection
 Overview
 Negative inserts
 Positive inserts
 PCBN & PCD inserts
 Heavy turning
 External Toolholders
 Internal Toolholders
 Automatic Lathes
 Spare Parts
 Technical Data

SUITABLE CLAMPING SYSTEM DEFINITION

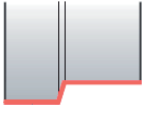
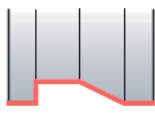
Definição do sistema de fixação | Definición del sistema de Fijación

Operation		Longitudinal turning	Profiling	Facing	Plunging
					
Negative inserts	(C) TOP CLAMP SYSTEM	●	●	●	●
	(D) DIMPLE LOCK SYSTEM	●●	●●	●●	
	(M) WEDGE CLAMP SYSTEM = (M-K) DOUBLE LOCK SYSTEM	●	●	●	
	(P) LEVER LOCK SYSTEM	●	●	●	
Positive inserts	(C) TOP CLAMP SYSTEM	●	●	●	●
	(P) LEVER LOCK SYSTEM		●		
	(S) CENTER SCREW SYSTEM	●●	●●	●●	

●● Recommended Insert Shape ● Alternative Insert Shape

- TURNING
- Insert selection
- Overview
- Negative inserts
- Positive inserts
- PCBN & PCD inserts
- Heavy turning
- External Toolholders
- Internal Toolholders
- Automatic Lathes
- Spare Parts
- Technical Data

(D) DIMPLE LOCK SYSTEM

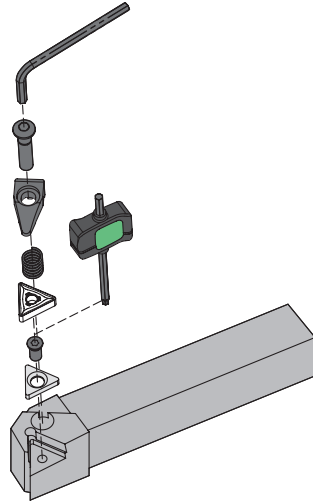

Positive inserts	Negative inserts	Overview	Insert selection	TURNING
<p>DCLN 95°</p> <p>PAGE C - 542 CN.. 1204.. CN.. 1906..</p>	<p>DDJN 93°</p> <p>PAGE C - 543 DN.. 1104.. DN.. 1506..</p>	<p>DSSN 45°</p> <p>PAGE C - 544 SN.. 1204.. SN.. 1906..</p>	<p>DTGN 90°</p> <p>PAGE C - 545 TN.. 1604.. TN.. 2204..</p>	<p>DWLN 95°</p> <p>PAGE C - 546 WN.. 0604.. WN.. 0804..</p>

(M) WEDGE CLAMP SYSTEM

(M-K) DOUBLE LOCK SYSTEM

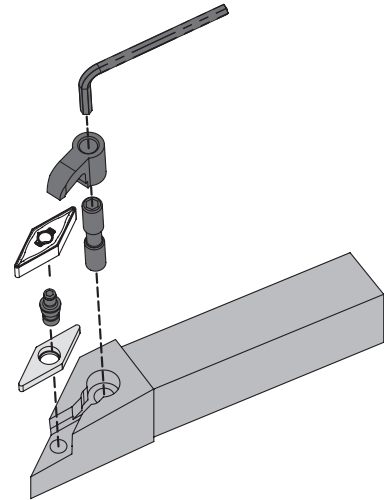
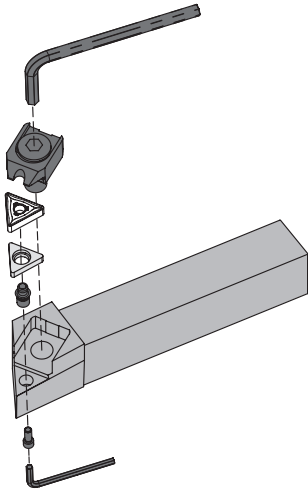

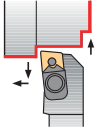
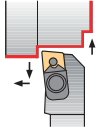
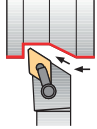
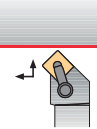
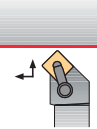
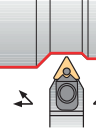
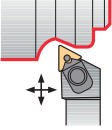
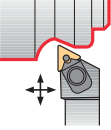
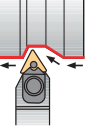
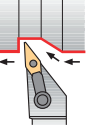
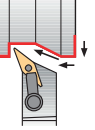
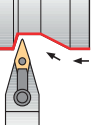
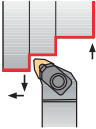
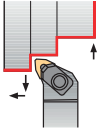
<p>MCLN 95°</p>  <p>PAGE C - 548 CN.. 1204.. CN.. 1906..</p>	<p>MCLN-K 95°</p>  <p>PAGE C - 549 CN.. 1204.. CN.. 1906..</p>	<p>MDJN-K 93°</p>  <p>PAGE C - 550 DN.. 1506..</p>	<p>MSSN-K 45°</p>  <p>PAGE C - 551 SN.. 1204..</p>	<p>MSSN 45°</p>  <p>PAGE C - 552 SN.. 1204.. SN.. 1906..</p>	<p>MTEN 60°</p>  <p>PAGE C - 553 TN.. 1604.. TN.. 2204..</p>
<p>MTJN 93°</p>  <p>PAGE C - 554 TN.. 1604.. TN.. 2204..</p>	<p>MTJN-K 93°</p>  <p>PAGE C - 555 TN.. 1604.. TN.. 2204..</p>	<p>MTNN 63°</p>  <p>PAGE C - 556 TN.. 1604.. TN.. 2204..</p>	<p>MVJN-K 93°</p>  <p>PAGE C - 557 VN.. 1604..</p>	<p>MVQN-K 117°30'</p>  <p>PAGE C - 558 VN.. 1604..</p>	<p>MVVN-K 72°30'</p>  <p>PAGE C - 559 VN.. 1604..</p>
<p>MWLN 95°</p>  <p>PAGE C - 560 WN.. 0604.. WN.. 0804..</p>	<p>MWLN-K 95°</p>  <p>PAGE C - 561 WN.. 0804..</p>				

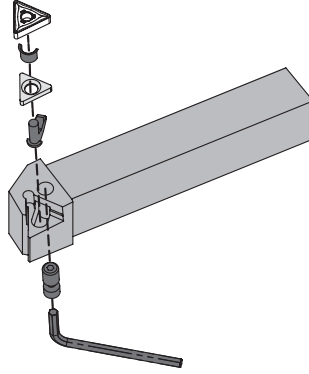

(P) LEVER LOCK SYSTEM

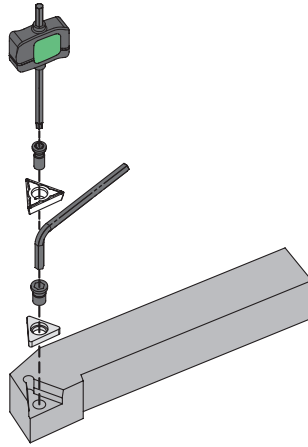

<p>PCBN 75°</p> <p>PAGE C - 563 CN.. 1204.. CN.. 1606.. CN.. 1906.. CN..2509..</p>	<p>PCFN 90°</p> <p>PAGE C - 564 CN.. 1204.. CN.. 1606.. CN.. 1906..</p>	<p>PCKN 75°</p> <p>PAGE C - 565 CN.. 1204... CN.. 1906.. CN.. 2506..</p>	<p>PCLN 95°</p> <p>PAGE C - 566 CN..0903.. ... CN..2509..</p>	<p>PCMN 50°</p> <p>PAGE C - 568 SN.. 1204.. SN.. 1906..</p>	<p>PCSN 45°</p> <p>PAGE C - 569 CN.. 1204.. CN.. 1606.. CN.. 1906..</p>
<p>PDJN 93°</p> <p>PAGE C - 570 DN.. 1104.. DN.. 1504.. DN.. 1506..</p>	<p>PDNN 63°</p> <p>PAGE C - 571 DN.. 1504.. DN.. 1506..</p>	<p>PRDC</p> <p>PAGE C - 572 RC.. 1003M0 ... RC.. 3209M0</p>	<p>PRSC</p> <p>PAGE C - 574 RC.. 10..32</p>	<p>PRSN</p> <p>PAGE C - 575 RN.. 09..25</p>	<p>PSBN 75°</p> <p>PAGE C - 576 SN.. 0903.. ... SN.. 2507..</p>
<p>PSDN 45°</p> <p>PAGE C - 577 SN.. 0903.. ... SN.. 2507..</p>	<p>PSKN 75°</p> <p>PAGE C - 578 SN.. 0903.. ... SN.. 2507..</p>	<p>PSSN 45°</p> <p>PAGE C - 579 SN.. 0903.. ... SN.. 2507..</p>	<p>PTDN 45°</p> <p>PAGE C - 580 TN.. 2204..</p>	<p>PTFN 90°</p> <p>PAGE C - 581 TN.. 1604.. TN.. 2204.. TN.. 2706..</p>	<p>PTGN 90°</p> <p>PAGE C - 582 TN.. 1604.. ... TN.. 3307..</p>
<p>PTTN 60°</p> <p>PAGE C - 583 TN.. 1604.. TN.. 2204..</p>	<p>PWLN 95°</p> <p>PAGE C - 584 WN.. 0604.. WN.. 0804..</p>				

(S) CENTER SCREW SYSTEM

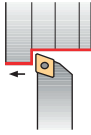
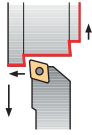
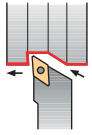
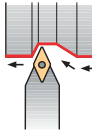
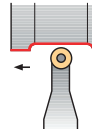
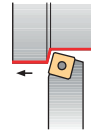
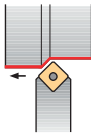
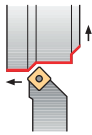
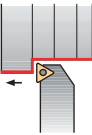
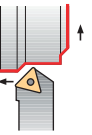
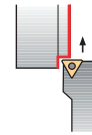
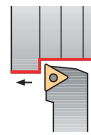
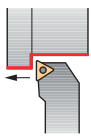
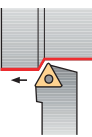
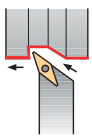
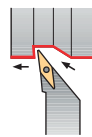
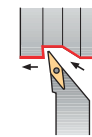

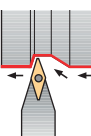
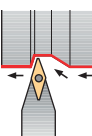
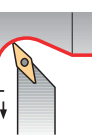
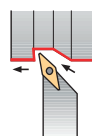
<p>SCAC 90°</p>  <p>PAGE C - 586 CC.. 0602.. CC.. 09T3.. CC.. 1204..</p>	<p>SCLC 95°</p>  <p>PAGE C - 587 CC.. 0602.. CC.. 09T3.. CC.. 1204..</p>	<p>SDJC 93°</p>  <p>PAGE C - 588 DC.. 0702.. DC.. 11T3..</p>	<p>SDNC 62°30'</p>  <p>PAGE C - 589 DC.. 0702.. DC.. 11T3..</p>	<p>SRDC</p>  <p>PAGE C - 590 RC.. 0602M0.. ... RC.. 1204M0..</p>	<p>SSBC 75°</p>  <p>PAGE C - 591 SC.. 09T3.. SC.. 1204..</p>
<p>SSDC 45°</p>  <p>PAGE C - 592 SC.. 09T3.. SC.. 1204..</p>	<p>SSSC 45°</p>  <p>PAGE C - 593 SC.. 09T3.. SC.. 1204..</p>	<p>STAC 90°</p>  <p>PAGE C - 594 TC.. 0902.. TC.. 1102.. TC.. 16T3..</p>	<p>STDC 45°</p>  <p>PAGE C - 595 TC.. 0902.. TC.. 1102.. TC.. 16T3..</p>	<p>STFC 90°</p>  <p>PAGE C - 596 TC.. 0902.. TC.. 1102.. TC.. 16T3..</p>	<p>STGC 90°</p>  <p>PAGE C - 597 TC.. 0902.. TC.. 1102.. TC.. 16T3..</p>
<p>STJC 93°</p>  <p>PAGE C - 598 TC.. 0902.. TC.. 1102.. TC.. 16T3..</p>	<p>STTC 60°</p>  <p>PAGE C - 599 TC.. 0902.. TC.. 1102.. TC.. 16T3..</p>	<p>SVHC 107°30'</p>  <p>PAGE C - 600 VC.. 1604..</p>	<p>SVJB 93°</p>  <p>PAGE C - 601 VB.. 1604..</p>	<p>SVJC 93°</p>  <p>PAGE C - 602 VC.. 1103.. VC.. 1604..</p>	<p>SVLC 95°</p>  <p>PAGE C - 603 VC.. 1303..</p>
<p>SVVB 72°30'</p>  <p>PAGE C - 604 VB.. 1604..</p>	<p>SVVC 72°30'</p>  <p>PAGE C - 605 VC.. 1103.. VC.. 1604..</p>	<p>SVXC 113°</p>  <p>PAGE C - 606 VC.. 1803..</p>	<p>SVZC 100°</p>  <p>PAGE C - 607 VC.. 1604..</p>		



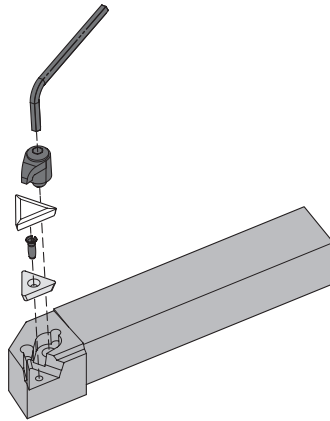





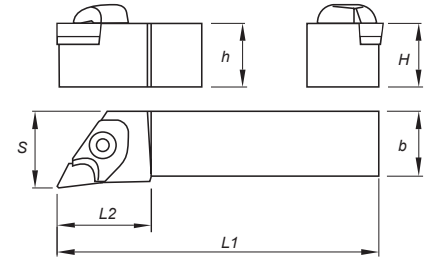
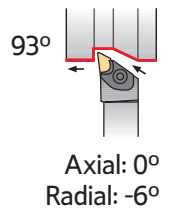
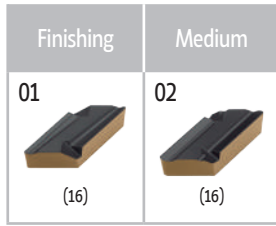

(C) TOP CLAMP SYSTEM



<p>CKJN 93°</p> <p>PAGE C - 527 KNUX 1604..</p>	<p>CKNN 63°</p> <p>PAGE C - 528 KNUX 1604..</p>	<p>CSBP 75°</p> <p>PAGE C - 529 SP. 0903.. SP. 1203.. SP. 1904..</p>	<p>CSDP 45°</p> <p>PAGE C - 530 SP. 0903.. SP. 1203..</p>	<p>CSKP 75°</p> <p>PAGE C - 531 SP. 0903.. SP. 1203.. SP. 1904..</p>	<p>CSSP 45°</p> <p>PAGE C - 532 SP. 0903.. SP. 1203.. SP. 1904..</p>
<p>CSTP 60°</p> <p>PAGE C - 533 SP.0903.. SP.1203..</p>	<p>CTBP 75°</p> <p>PAGE C - 534 TP. 1103.. TP. 1603.. TP. 2204..</p>	<p>CTCP N 90°</p> <p>PAGE C - 535 TP. 1103.. TP. 1603.. TP. 2204..</p>	<p>CTCP 90°</p> <p>PAGE C - 536 TP. 1103.. TP. 1603.. TP. 2204..</p>	<p>CTDP 45°</p> <p>PAGE C - 537 TP. 1103.. TP. 1603.. TP. 2204..</p>	<p>CTFP 90°</p> <p>PAGE C - 538 TP. 1103.. TP. 1603.. TP. 2204..</p>
<p>CTGP 90°</p> <p>PAGE C - 539 TP. 1103.. TP. 1603.. TP. 2204..</p>	<p>CTTP 60°</p> <p>PAGE C - 540 TP. 0902.. TP. 1103.. TP. 2204..</p>				

(C) TOP CLAMP TOOLHOLDERS









































































Order Code		Reference	Dimensions (mm)					Insert	Kg	Stock	
R	L		H=h	b	L1	L2	S			R	L
212034800	212034900	CKJN R/L 2020 K16	20	20	125	34	30	KNUX 1604..	0,390		
212026300	212035000	CKJN R/L 2525 M16	25	25	150	34	32	KNUX 1604..	0,700		
212010300	212260400	CKJN R/L 3225 P16	32	25	170	34	32	KNUX 1604..	1,000		
212260500	212260600	CKJN R/L 3232 P16	32	32	170	34	40	KNUX 1604..	1,250		
212260700	212260800	CKJN R/L 4025 R16	40	25	200	34	32	KNUX 1604..	1,500		

 Stock Items | Itens de stock





 Available under request | Disponível sob consulta | Disponible bajo consulta

SPARE PARTS || Complementos | Repuestos

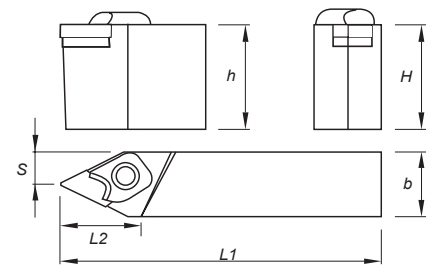
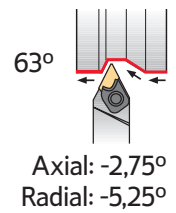
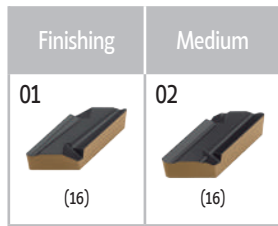
Cutter Reference	Order separately						
	Shim	Shim Pin	Shim Pin Punch	Spring	Clamp	Screw	Wrench
CKJN R 2020 K16	 CK160500	 BE03000	 BF04813	 M09513	 GAW1400	 DW142600	 SS40
CKJN R 2525 M16	 CK160500	 BE03000	 BF04815	 M09513	 GAW1400	 DW142600	 SS40
CKJN R 3225 P16	 CK160500	 BE03000	 BF04815	 M09513	 GAW1400	 DW142600	 SS40
CKJN R 3232 P16	 CK160500	 BE03000	 BF04815	 M09513	 GAW1400	 DW142600	 SS40
CKJN R 4025 R16	 CK160500	 BE03000	 BF04815	 M09513	 GAW1400	 DW142600	 SS40
CKJN L 2020 K16	 CK160501	 BE03000	 BF04813	 M09513	 GAW1401	 DW142600	 SS40
CKJN L 2525 M16	 CK160501	 BE03000	 BF04815	 M09513	 GAW1401	 DW142600	 SS40
CKJN L 3225 P16	 CK160501	 BE03000	 BF04815	 M09513	 GAW1401	 DW142600	 SS40
CKJN L 3232 P16	 CK160501	 BE03000	 BF04815	 M09513	 GAW1401	 DW142600	 SS40
CKJN L 4025 R16	 CK160501	 BE03000	 BF04815	 M09513	 GAW1401	 DW142600	 SS40

(C) TOP CLAMP TOOLHOLDERS









Order Code		Reference	Dimensions (mm)					Insert	Kg	Stock	
R	L		H-h	b	L1	L2	S			R	L
212260900	212261000	CKNN R/L 4025 R16	40	25	200	37	14,3	KNUX 1604..	1,500		
212261100	212261200	CKNN R/L 5032 S16	50	32	250	37	16,8	KNUX 1604..	3,000		



 Stock Items | Itens de stock

 Available under request | Disponível sob consulta | Disponible bajo consulta









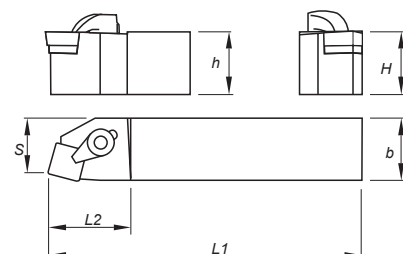
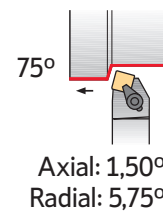









SPARE PARTS || Complementos | Repuestos

Cutter Reference	Order separately						
	Shim	Shim Pin	Shim Pin Punch	Spring	Clamp	Screw	Wrench
CKNN R 4025 R16							
CKNN R 5032 S16	CK160500	BE03000	BF04815	M09513	GAW1400	DW142600	SS40
CKNN L 4025 R16	CK160501	BE03000	BF04815	M09513	GAW1401	DW142600	SS40
CKNN L 5032 S16	CK160501	BE03000	BF04815	M09513	GAW1401	DW142600	SS40

(C) TOP CLAMP TOOLHOLDERS

Medium to Finishing	Finishing to Fine Finishing	Medium
Flat  (09-12-19)	12  (09-12)	13  (09-12)









Order Code		Reference	Dimensions (mm)					Insert	Kg	Stock	
R	L		H=h	b	L1	L2	S			R	L
212042000	212261300	CSBP R/L 1212 F09	12	12	80	22	11	SP..0903..	0,070		
212261400	212261500	CSBP R/L 1616 H09	16	16	100	22	13	SP..0903..	0,200		
212261600	212261700	CSBP R/L 2020 K09	20	20	125	22	17	SP..0903..	0,400		
212261800	212033900	CSBP R/L 2020 K12	20	20	125	34	17	SP..1203..	0,400		
212034000	212034100	CSBP R/L 2525 M12	25	25	150	34	22	SP..1203..	0,700		
212261900	212262000	CSBP R/L 3225 P12	32	25	170	34	22	SP..1203..	1,000		
212262100	212262200	CSBP R/L 3232 P19	32	32	170	40	27	SP..1904..	1,250		
212262300	212262400	CSBP R/L 4040 S19	40	40	250	40	35	SP..1904..	3,000		
212262500	212262600	CSBP R/L 5050 T19	50	50	300	40	43	SP..1904..	5,650		

 Stock Items | Itens de stock

 Available under request | Disponível sob consulta | Disponible bajo consulta

SPARE PARTS || Complementos | Repuestos



Complementary Accessories - Flat Inserts

Cutter Reference	Shim	Shim Pin	Clamp	Wrench	Clamp	Chip Breaker 1	Chip Breaker 2
							
CSBP R/L 1212 F09	CS090300	BE02100	GS05001	SS25	GS05004	QCS0900	-
CSBP R/L 1616 H09	CS090300	BE02100	GS05001	SS25	GS05004	QCS0900	-
CSBP R/L 2020 K09	CS090300	BE02100	GS05001	SS25	GS05004	QCS0900	-
CSBP R/L 2020 K12	CS120300	BE02100	GS06000	SS30	GS05005	QCS1200	QCS1201
CSBP R/L 2525 M12	CS120300	BE02100	GS06000	SS30	GS05005	QCS1200	QCS1201
CSBP R/L 3225 P12	CS120300	BE02100	GS06000	SS30	GS05005	QCS1200	QCS1201
CSBP R/L 3232 P19	CS190300	BE03000	GS08000	SS40	GS08001	QCS1900	QCS1901
CSBP R/L 4040 S19	CS190300	BE03000	GS08000	SS40	GS08001	QCS1900	QCS1901
CSBP R/L 5050 T19	CS190300	BE03000	GS08000	SS40	GS08001	QCS1900	QCS1901

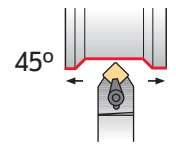







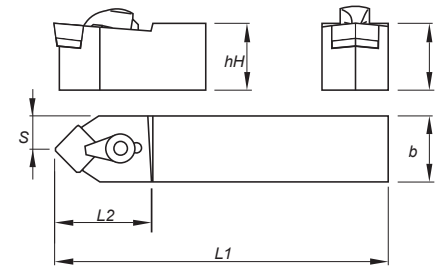





(C) TOP CLAMP TOOLHOLDERS



Axial: 4,25°
Radial: 4,25°

Medium to Finishing	Finishing to Fine Finishing	Medium
Flat  (09-12)	12  (09-12)	13  (09-12)









Order Code		Reference	Dimensions (mm)					Insert	Kg	Stock	
R	L		H=h	b	L1	L2	S			R	L
212262700	212262800	CSDP R/L 1010 E09	10	10	70	22	5,6	SP.. 0903..	0,030		
212262900	212263000	CSDP R/L 1212 F09	12	12	80	22	7,6	SP.. 0903..	0,070		
212263100	212263200	CSDP R/L 1616 H09	16	16	100	22	11,6	SP.. 0903..	0,200		
212263300	212263400	CSDP R/L 2020 K12	20	20	125	28	14,0	SP.. 1203..	0,400		
212263500	212263600	CSDP R/L 2525 M12	25	25	150	28	19,0	SP.. 1203..	0,700		
212263700		CSDP N 1010 E09	10	10	70	22	5,0	SP.. 0903..	0,030		
212263800		CSDP N 1212 F09	12	12	80	22	6,0	SP.. 0903..	0,070		
212263900		CSDP N 1616 H09	16	16	100	22	8,0	SP.. 0903..	0,200		
212018400		CSDP N 2020 K12	20	20	125	28	10,0	SP.. 1203..	0,400		
212264000		CSDP N 2525 M12	25	25	150	28	12,5	SP.. 1203..	0,700		

 Stock Items | Itens de stock

 Available under request | Disponível sob consulta | Disponible bajo consulta

SPARE PARTS | Complementos | Repuestos

Complementary Accessories - Flat Inserts

Cutter Reference	Shim 	Shim Pin 	Clamp 	Wrench 	Clamp 	Chip Breaker 1 	Chip Breaker 2 
CSDP R/L 1010 E09	-	-	GS05000	SS25	-	QCS0901	QCS0902
CSDP R/L 1212 F09	CS090300	BE02100	GS05001	SS25	GS05004	QCS0901	QCS0902
CSDP R/L 1616 H09	CS090300	BE02100	GS05001	SS25	GS05004	QCS0901	QCS0902
CSDP R/L 2020 K12	CS120300	BE02100	GS06000	SS30	GS05005	QCS1202	QCS1203
CSDP R/L 2525 M12	CS120300	BE02100	GS06000	SS30	GS05005	QCS1202	QCS1203
CSDP N 1010 E09	-	-	GS05000	SS25	-	QCS0901	QCS0902
CSDP N 1212 F09	CS090300	BE02100	GS05001	SS25	GS05004	QCS0901	QCS0902
CSDP N 1616 H09	CS090300	BE02100	GS05001	SS25	GS05004	QCS0901	QCS0902
CSDP N 2020 K12	CS120300	BE02100	GS06000	SS30	GS05005	QCS1202	QCS1203
CSDP N 2525 M12	CS120300	BE02100	GS06000	SS30	GS05005	QCS1202	QCS1203

(C) TOP CLAMP TOOLHOLDERS

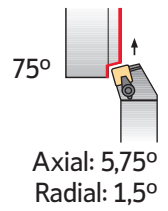

Medium to Finishing	Finishing to Fine Finishing	Medium
Flat (09-12-19)	12 (09-12)	13 (09-12)

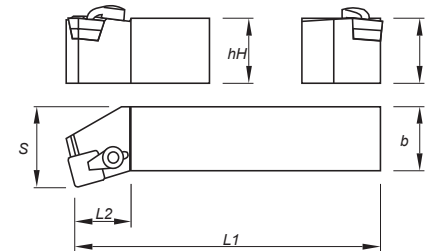

Order Code		Reference	Dimensions (mm)					Insert	Kg	Stock	
R	L		H=h	b	L1	L2	S			R	L
212042100	212264100	CSKP R/L 1212 F09	12	12	80	18	16	SP.0903..	0,070		
212264200	212264300	CSKP R/L 1616 H09	16	16	100	22	20	SP.0903..	0,200		
212264400	212264500	CSKP R/L 2020 K09	20	20	125	22	25	SP.0903..	0,400		
212034200	212034300	CSKP R/L 2020 K12	20	20	125	28	25	SP.1203..	0,400		
212036000	212034400	CSKP R/L 2525 M12	25	25	150	28	32	SP.1203..	0,700		
212264600	212264700	CSKP R/L 3225 P12	32	25	170	28	32	SP.1203..	1,000		
212264800	212264900	CSKP R/L 3232 P19	32	32	170	42	40	SP.1904..	1,250		
212265000	212265100	CSKP R/L 4040 S19	40	40	250	42	50	SP.1904..	3,000		
212265200	212265300	CSKP R/L 5050 T19	50	50	300	42	60	SP.1904..	5,650		

Stock Items | Itens de stock



Available under request | Disponível sob consulta | Disponible bajo consulta

SPARE PARTS || Complementos | Repuestos

Complementary Accessories - Flat Inserts

Cutter Reference	Shim	Shim Pin	Clamp	Wrench	Clamp	Chip Breaker 1	Chip Breaker 2
CSKP R/L 1212 F09	CS090300	BE02100	GS05001	SS25	GS05004	QCS0900	-
CSKP R/L 1616 H09	CS090300	BE02100	GS05001	SS25	GS05004	QCS0900	-
CSKP R/L 2020 K09	CS090300	BE02100	GS05001	SS25	GS05004	QCS0900	-
CSKP R/L 2020 K12	CS120300	BE02100	GS06000	SS30	GS05005	QCS1200	QCS1201
CSKP R/L 2525 M12	CS120300	BE02100	GS06000	SS30	GS05005	QCS1200	QCS1201
CSKP R/L 3225 P12	CS120300	BE02100	GS06000	SS30	GS05005	QCS1200	QCS1201
CSKP R/L 3232 P19	CS190300	BE03000	GS08000	SS40	GS08001	QCS1900	QCS1901
CSKP R/L 4040 S19	CS190300	BE03000	GS08000	SS40	GS08001	QCS1900	QCS1901
CSKP R/L 5050 T19	CS190300	BE03000	GS08000	SS40	GS08001	QCS1900	QCS1901





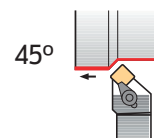



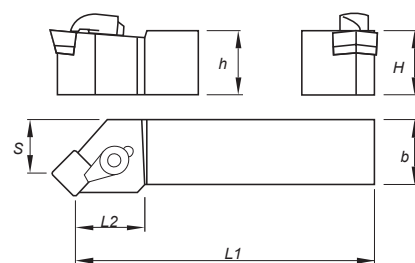





(C) TOP CLAMP TOOLHOLDERS

Medium to Finishing	Finishing to Fine Finishing	Medium
Flat  (09-12-19)	12  (09-12)	13  (09-12)



Axial: 4,25°
Radial: 4,25°



Order Code		Reference	Dimensions (mm)					Insert	Kg	Stock	
R	L		H=h	b	L1	L2	S			R	L
212019000	212018800	CSSP R/L 1212 F09	12	12	80	22	16	SP.. 0903..	0,070		
212265400	212265500	CSSP R/L 1616 H09	16	16	100	22	20	SP.. 0903..	0,200		
212034500	212034600	CSSP R/L 2020 K12	20	20	125	22	25	SP.. 1203..	0,400		
212036100	212034700	CSSP R/L 2525 M12	25	25	150	28	32	SP.. 1203..	0,700		
212265600	212265700	CSSP R/L 3225 P12	32	25	170	28	32	SP.. 1203..	1,000		
212265800	212265900	CSSP R/L 3232 P19	32	32	170	42	40	SP.. 1904..	1,250		
212266000	212266100	CSSP R/L 4040 S19	40	40	250	42	50	SP.. 1904..	3,000		

 Stock Items | Itens de stock



 Available under request | Disponível sob consulta | Disponible bajo consulta

SPARE PARTS || Complementos | Repuestos







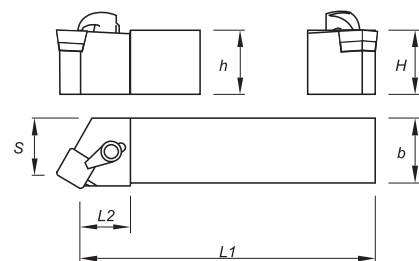
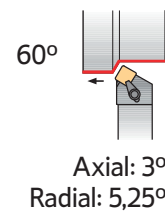

Complementary Accessories - Flat Inserts

Cutter Reference	Shim 	Shim Pin 	Clamp 	Wrench 	Clamp 	Chip Breaker 1 	Chip Breaker 2 
CSSP R/L 1212 F09	CS090300	BE02100	GS05001	SS25	GS05004	QCS0901	QCS0902
CSSP R/L 1616 H09	CS090300	BE02100	GS05001	SS25	GS05004	QCS0901	QCS0902
CSSP R/L 2020 K12	CS120300	BE02100	GS06000	SS30	GS05005	QCS1202	QCS1203
CSSP R/L 2525 M12	CS120300	BE02100	GS06000	SS30	GS05005	QCS1202	QCS1203
CSSP R/L 3225 P12	CS120300	BE02100	GS06000	SS30	GS05005	QCS1202	QCS1203
CSSP R/L 3232 P19	CS190300	BE03000	GS08000	SS40	GS08001	QCS1902	QCS1903
CSSP R/L 4040 S19	CS190300	BE03000	GS08000	SS40	GS08001	QCS1902	QCS1903

(C) TOP CLAMP TOOLHOLDERS

Medium to Finishing	Finishing to Fine Finishing	Medium
Flat	12	13
		
(09-12)	(09-12)	(09-12)









Order Code		Reference	Dimensions (mm)					Insert	Kg	Stock	
R	L		H=h	b	L1	L2	S			R	L
212266200	212266300	CSTP R/L 1616 H09	16	16	100	22	13	SP.0903..	0,200		
212266400	212266500	CSTP R/L 2020 K09	20	20	125	22	17	SP.0903..	0,350		
212266600	212266700	CSTP R/L 2020 K12	20	20	125	28	17	SP.1203..	0,400		
212266800	212266900	CSTP R/L 2525 M12	25	25	150	28	22	SP.1203..	0,700		

 Stock Items | Itens de stock



Available under request | Disponível sob consulta | Disponible bajo consulta

SPARE PARTS || Complementos | Repuestos

Complementary Accessories - Flat Inserts

Cutter Reference	Shim	Shim Pin	Clamp	Wrench	Clamp	Chip Breaker 1	Chip Breaker 2
							
CSTP R/L 1616 H09	CS090300	BE02100	GS05001	SS25	GS05004	QCS0900	-
CSTP R/L 2020 K09	CS090300	BE02100	GS05001	SS25	GS05004	QCS0900	-
CSTP R/L 2020 K12	CS120300	BE02100	GS06000	SS30	GS05005	QCS1200	QCS1201
CSTP R/L 2525 M12	CS120300	BE02100	GS06000	SS30	GS05005	QCS1200	QCS1201





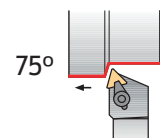

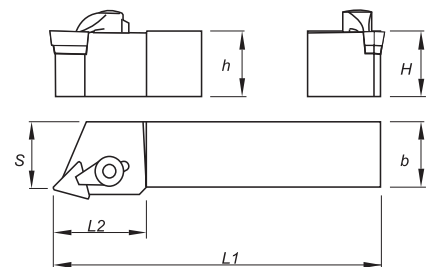

(C) TOP CLAMP TOOLHOLDERS

Medium to Finishing	Finishing to Fine Finishing	Medium
Flat  (11-16)	12  (11-16)	13  (11-16)



Axial: 1,5°
Radial: 5,75°









Order Code		Reference	Dimensions (mm)					Insert	Kg	Stock	
R	L		H=h	b	L1	L2	S			R	L
212267000	212267100	CTBP R/L 1212 F11	12	12	80	18	11	TP. 1103..	0,070		
212267200	212267300	CTBP R/L 1616 H11	16	16	100	22	13	TP. 1103..	0,200		
212267400	212267500	CTBP R/L 2020 K16	20	20	125	28	17	TP. 1603..	0,400		
212267600	212267700	CTBP R/L 2525 M16	25	25	150	28	22	TP. 1603..	0,700		

 Stock Items | Itens de stock



Available under request | Disponível sob consulta | Disponible bajo consulta

SPARE PARTS || Complementos | Repuestos





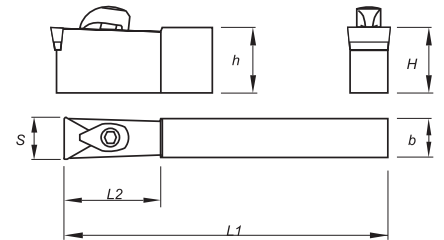
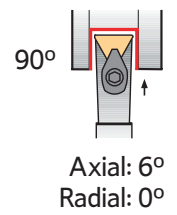

Complementary Accessories - Flat Inserts

Cutter Reference	Shim	Shim Pin	Clamp	Wrench	Clamp	Chip Breaker 1	Chip Breaker 2
							
CTBP R/L 1212 F11	-	-	GS05001	SS25	GS05004	QCT1100	-
CTBP R/L 1616 H11	-	-	GS05001	SS25	GS05004	QCT1100	-
CTBP R/L 2020 K16	CT160301	BE02100	GS06000	SS30	GS05005	QCT1600	QCT1601
CTBP R/L 2525 M16	CT160301	BE02100	GS06000	SS30	GS05005	QCT1600	QCT1601

(C) TOP CLAMP TOOLHOLDERS

Medium to Finishing	Finishing to Fine Finishing	Medium
Flat  (11-16-22)	12  (11-16)	13  (11-16-22)



Order Code	Reference	Dimensions (mm)					Insert	Kg	Stock
		H=h	b	L1	L2	S			
212267800	CTCP N 1009 E11	10	9	70	22	11	TP.. 1103..	0,040	
212267900	CTCP N 2009 K11	20	9	125	22	11	TP.. 1103..	0,150	
212268000	CTCP N 2509 R11	25	9	200	22	11	TP.. 1103..	0,350	
212268100	CTCP N 2513 R16	25	13	200	28	16	TP.. 1603..	0,500	
212268200	CTCP N 2518 R22	25	18	200	34	22	TP.. 2204..	0,650	
212268300	CTCP N 4018 R22	40	18	200	34	22	TP.. 2204..	1,100	

 Stock Items | Itens de stock

 Available under request | Disponível sob consulta | Disponible bajo consulta

SPARE PARTS || Complementos | Repuestos

Cutter Reference	Shim	Shim Pin	Clamp	Wrench	Chip Breaker 1	Chip Breaker 2
CTCP N 1009 E11						
CTCP N 1009 E11	-	-	GS04000	SS25	QCT1100	QCT1101
CTCP N 2009 K11	-	-	GS04000	SS25	QCT1100	QCT1101
CTCP N 2509 R11	-	-	GS04000	SS25	QCT1100	QCT1101
CTCP N 2513 R16	CT160301	BE02100	GS05002	SS30	QCT1600	QCT1601
CTCP N 2518 R22	CT220301	BE03000	GS08000	SS40	QCT2200	QCT2201
CTCP N 4018 R22	CT220301	BE03000	GS08000	SS40	QCT2200	QCT2201

(C) TOP CLAMP TOOLHOLDERS

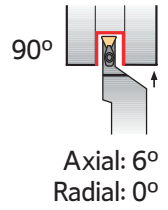

Medium to Finishing	Finishing to Fine Finishing	Medium
Flat (11-16-22)	12 (11-16)	13 (11-16-22)

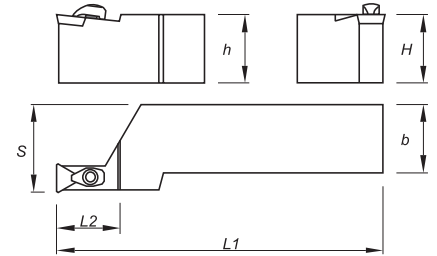

Order Code		Reference	Dimensions (mm)					Insert	Kg	Stock	
R	L		H=h	b	L1	L2	S			R	L
212268400	212268500	CTCP R/L 1212 F11	12	12	80	22	16	TP.. 1103..	0,070		
212268600	212268700	CTCP R/L 1616 H11	16	16	100	22	20	TP.. 1103..	0,200		
212268800	212268900	CTCP R/L 2020 K11	20	20	125	22	25	TP.. 1103..	0,400		
212269000	212269100	CTCP R/L 2525 M11	25	25	150	22	32	TP.. 1103..	0,700		
212269200	212269300	CTCP R/L 3225 P16	32	32	170	28	32	TP.. 1603..	1,000		
212269400	212269500	CTCP R/L 3232 P16	32	32	170	28	40	TP.. 1603..	1,250		
212269600	212269700	CTCP R/L 3225 P22	32	25	170	34	32	TP.. 2204..	1,000		
212269800	212269900	CTCP R/L 3232 P22	32	32	170	34	40	TP.. 2204..	1,250		



Stock Items | Itens de stock

Available under request | Disponível sob consulta | Disponible bajo consulta









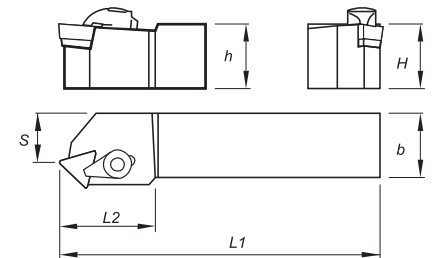
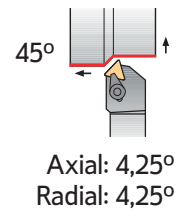



SPARE PARTS | Complementos | Repuestos

Cutter Reference	Order separately					
	Shim	Shim Pin	Shim Pin Punch	Spring	Clamp	Screw
CTCP R/L 1212 F11	-	-	GS04000	SS25	QCT1100	QCT1101
CTCP R/L 1616 H11	-	-	GS04000	SS25	QCT1100	QCT1101
CTCP R/L 2020 K11	-	-	GS04000	SS25	QCT1100	QCT1101
CTCP R/L 2525 M11	-	-	GS04000	SS25	QCT1100	QCT1101
CTCP R/L 3225 P16	CT160301	BE02100	GS05002	SS30	QCT1600	QCT1601
CTCP R/L 3232 P16	CT160301	BE02100	GS05002	SS30	QCT1600	QCT1601
CTCP R/L 3225 P22	CT220301	BE03000	GS08000	SS40	QCT2200	QCT2201
CTCP R/L 3232 P22	CT220301	BE03000	GS08000	SS40	QCT2200	QCT2201

(C) TOP CLAMP TOOLHOLDERS

Medium to Finishing	Finishing to Fine Finishing	Medium
Flat  (11-16-22)	12  (11-16)	13  (11-16-22)



Order Code		Reference	Dimensions (mm)					Insert	Kg	Stock	
R	L		H=h	b	L1	L2	S			R	L
212270000	212270100	CTDP R/L 1212 F11	12	12	80	20	6,3	TP.. 1103..	0,070		
212019400	212270200	CTDP R/L 1616 H11	16	16	100	22	10,3	TP.. 1103..	0,200		
212270300	212270400	CTDP R/L 2020 K16	20	20	125	28	12,2	TP.. 1603..	0,400		
212270500	212019300	CTDP R/L 2525 M16	25	25	150	28	17,2	TP.. 1603..	0,700		
212270600	212270700	CTDP R/L 3232 P16	32	32	170	28	23,5	TP.. 1603..	1,250		
212270800	212270900	CTDP R/L 3232 P22	32	32	170	34	20,5	TP.. 2204..	1,250		

 Stock Items | Itens de stock

 Available under request | Disponível sob consulta | Disponible bajo consulta

SPARE PARTS | Complementos | Repuestos





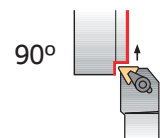
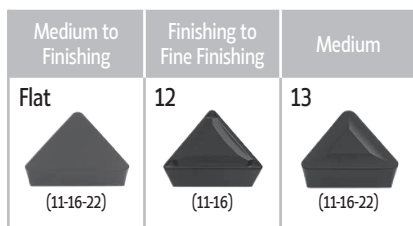



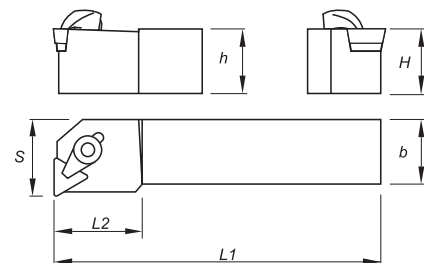

















Cutter Reference	Complementary Accessories - Flat Inserts						
	Shim	Shim Pin	Clamp	Wrench	Clamp	Chip Breaker 1	Chip Breaker 2
CTDP R/L 1212 F11							
CTDP R/L 1212 F11	-	-	GS05001	SS25	GS05004	QCT1100	QCT1101
CTDP R/L 1616 H11	-	-	GS05001	SS25	GS05004	QCT1100	QCT1101
CTDP R/L 2020 K16	CT160301	BE02100	GS06000	SS30	GS05005	QCT1600	QCT1601
CTDP R/L 2525 M16	CT160301	BE02100	GS06000	SS30	GS05005	QCT1600	QCT1601
CTDP R/L 3232 P16	CT160301	BE02100	GS06000	SS30	GS05005	QCT1600	QCT1601
CTDP R/L 3232 P22	CT220301	BE03000	GS08000	SS40	GS08001	QCT2200	QCT2201

(C) TOP CLAMP TOOLHOLDERS



Axial: 6°
Radial: 0°









Order Code		Reference	Dimensions (mm)					Insert	Kg	Stock	
R	L		H=h	b	L1	L2	S			R	L
212271000	212271100	CTFP R/L 1010 E11	10	10	70	16	12	TP.. 1103..	0,030		
212019800	212271200	CTFP R/L 1212 F11	12	12	80	18	16	TP.. 1103..	0,070		
212019900	212271300	CTFP R/L 1616 H11	16	16	100	22	20	TP.. 1103..	0,200		
212033600	212019500	CTFP R/L 2020 K11	20	20	125	22	25	TP.. 1103..	0,400		
212033700	212024000	CTFP R/L 2020 K16	20	20	125	22	25	TP.. 1603..	0,400		
212035900	212033800	CTFP R/L 2525 M16	25	25	150	22	32	TP.. 1603..	0,700		
212271400	212271500	CTFP R/L 3225 P16	32	25	170	22	32	TP.. 1603..	1,000		
212271600	212271700	CTFP R/L 3232 P16	32	32	170	28	40	TP.. 1603..	1,250		
212271800	212271900	CTFP R/L 4040 S16	40	40	250	34	50	TP.. 1603..	3,000		
212272000	212272100	CTFP R/L 5050 T16	50	50	300	34	60	TP.. 1603..	5,650		
212272200	212272300	CTFP R/L 3232 P22	32	32	170	34	40	TP.. 2204..	1,250		
212272400	212272500	CTFP R/L 4040 S22	40	40	250	34	50	TP.. 2204..	3,000		
212272600	212272700	CTFP R/L 5050 T22	50	50	300	34	60	TP.. 2204..	5,650		

 Stock Items | Itens de stock



 Available under request | Disponivel sob consulta | Disponible bajo consulta

SPARE PARTS | Complementos | Repuestos









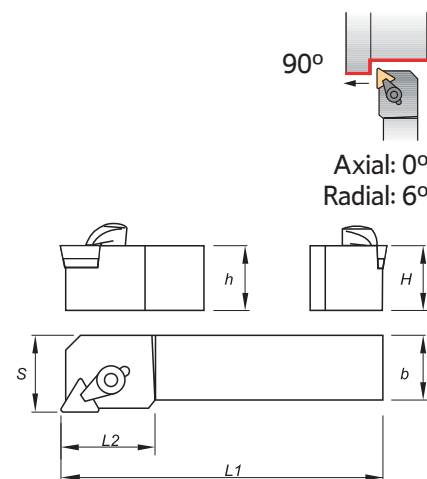











Complementary Accessories - Flat Inserts

Cutter Reference	Shim	Shim Pin	Clamp	Wrench	Clamp	Chip Breaker 1	Chip Breaker 2
							
CTFP R/L 1010 E11	-	-	GS03000	SS15	-	-	-
CTFP R/L 1212 F11	-	-	GS05001	SS25	GS05004	QCT1100	QCT1101
CTFP R/L 1616 H11	-	-	GS05001	SS25	GS05004	QCT1100	QCT1101
CTFP R/L 2020 K11	-	-	GS05001	SS25	GS05004	QCT1100	QCT1101
CTFP R/L 2020 K16	CT160301	BE02100	GS06000	SS30	GS05005	QCT1600	QCT1601
CTFP R/L 2525 M16	CT160301	BE02100	GS06000	SS30	GS05005	QCT1600	QCT1601
CTFP R/L 3225 P16	CT160301	BE02100	GS06000	SS30	GS05005	QCT1600	QCT1601
CTFP R/L 3232 P16	CT160301	BE02100	GS06000	SS30	GS05005	QCT1600	QCT1601
CTFP R/L 4040 S16	CT160301	BE02100	GS06000	SS30	GS05005	QCT1600	QCT1601
CTFP R/L 5050 T16	CT160301	BE02100	GS06000	SS30	GS05005	QCT1600	QCT1601
CTFP R/L 3232 P22	CT220301	BE03000	GS08000	SS40	GS08001	QCT2200	QCT2201
CTFP R/L 4040 S22	CT220301	BE03000	GS08000	SS40	GS08001	QCT2200	QCT2201
CTFP R/L 5050 T22	CT220301	BE03000	GS08000	SS40	GS08001	QCT2200	QCT2201

(C) TOP CLAMP TOOLHOLDERS

Medium to Finishing	Finishing to Fine Finishing	Medium
Flat  (11-16-22)	12  (11-16)	13  (11-16-22)









Order Code		Reference	Dimensions (mm)					Insert	Kg	Stock	
R	L		H=h	b	L1	L2	S			R	L
212272800	212272900	CTGP R/L 1010 E11	10	10	70	16	12	TP.. 1103..	0,030		
212273000	212020200	CTGP R/L 1212 F11	12	12	80	18	16	TP.. 1103..	0,070		
212273100	212273200	CTGP R/L 1616 H11	16	16	100	22	20	TP.. 1103..	0,200		
212033100	212033200	CTGP R/L 2020 K11	20	20	125	22	25	TP.. 1103..	0,400		
212033300	212033400	CTGP R/L 2020 K16	20	20	125	28	25	TP.. 1603..	0,400		
212035800	212033500	CTGP R/L 2525 M16	25	25	150	28	32	TP.. 1603..	0,700		
212273300	212273400	CTGP R/L 3225 P16	32	25	170	28	32	TP.. 1603..	1,000		
212273500	212273600	CTGP R/L 3232 P22	32	32	170	34	40	TP.. 2204..	1,250		
212273700	212273800	CTGP R/L 4040 S22	40	40	250	34	50	TP.. 2204..	3,000		
212273900	212274000	CTGP R/L 5050 T22	50	50	300	34	60	TP.. 2204..	5,650		

 Stock Items | Itens de stock



 Available under request | Disponível sob consulta | Disponible bajo consulta

SPARE PARTS | Complementos | Repuestos









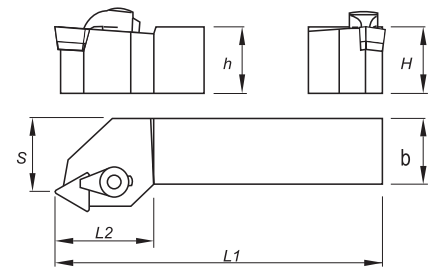
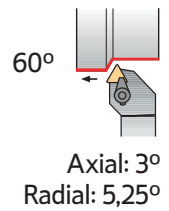







Complementary Accessories - Flat Inserts

Cutter Reference	Shim	Shim Pin	Clamp	Wrench	Clamp	Chip Breaker 1	Chip Breaker 2
							
CTGP R/L 1010 E11	-	-	GS03000	SS15	-	-	-
CTGP R/L 1212 F11	-	-	GS05001	SS25	GS05004	QCT1100	QCT1101
CTGP R/L 1616 H11	-	-	GS05001	SS25	GS05004	QCT1100	QCT1101
CTGP R/L 2020 K11	-	-	GS05001	SS25	GS05004	QCT1100	QCT1101
CTGP R/L 2020 K16	CT160301	BE02100	GS06000	SS30	GS05005	QCT1600	QCT1601
CTGP R/L 2525 M16	CT160301	BE02100	GS06000	SS30	GS05005	QCT1600	QCT1601
CTGP R/L 3225 P16	CT160301	BE02100	GS06000	SS30	GS05005	QCT1600	QCT1601
CTGP R/L 3232 P22	CT220301	BE03000	GS08000	SS40	GS08001	QCT2200	QCT2201
CTGP R/L 4040 S22	CT220301	BE03000	GS08000	SS40	GS08001	QCT2200	QCT2201
CTGP R/L 5050 T22	CT220301	BE03000	GS08000	SS40	GS08001	QCT2200	QCT2201

(C) TOP CLAMP TOOLHOLDERS

Medium to Finishing	Finishing to Fine Finishing	Medium
Flat  (11-16)	12  (09-11-16)	13  (09-11-16)



Order Code		Reference	Dimensions (mm)					Insert	Kg	Stock	
R	L		H=h	b	L1	L2	S			R	L
212249500	212274100	CTTP R/L 0808 D09	8	8	60	16	7	TP.. 0902..	0,020		
212274200	212274300	CTTP R/L 1010 E09	10	10	70	16	TP.. 0902..	0,030			
212274400	212274500	CTTP R/L 1010 E11	10	10	70	16	TP.. 1103..	0,030			
212274600	212274700	CTTP R/L 1212 F11	12	12	80	18	TP.. 1103..	0,070			
212274800	212274900	CTTP R/L 1616 H11	16	16	100	22	TP.. 1103..	0,200			
212275000	212275100	CTTP R/L 2020 K11	20	20	125	22	TP.. 1103..	0,400			
212275200	212275300	CTTP R/L 2020 K16	20	20	125	28	TP.. 1603..	0,400			
212247400	212275400	CTTP R/L 2525 M16	25	25	150	28	TP.. 1603..	0,700			

 Stock Items | Itens de stock

 Available under request | Disponível sob consulta | Disponible bajo consulta

SPARE PARTS | Complementos | Repuestos

Complementary Accessories - Flat Inserts

Cutter Reference	Shim	Shim Pin	Clamp	Wrench	Clamp	Chip Breaker 1	Chip Breaker 2
							
CTTP R/L 0808 D09	-	-	GS03000	SS15	-	-	-
CTTP R/L 1010 E09	-	-	GS03000	SS15	-	-	-
CTTP R/L 1010 E11	-	-	GS03000	SS15	GS05004	QCT1100	QCT1101
CTTP R/L 1212 F11	-	-	GS05001	SS25	GS05004	QCT1100	QCT1101
CTTP R/L 1616 H11	-	-	GS05001	SS25	GS05004	QCT1100	QCT1101
CTTP R/L 2020 K11	-	-	GS05001	SS25	GS05004	QCT1100	QCT1101
CTTP R/L 2020 K16	CT160301	BE02100	GS06000	SS30	GS05005	QCT1600	QCT1601
CTTP R/L 2525 M16	CT160301	BE02100	GS06000	SS30	GS05005	QCT1600	QCT1601

(D) DIMPLE LOCK SYSTEM

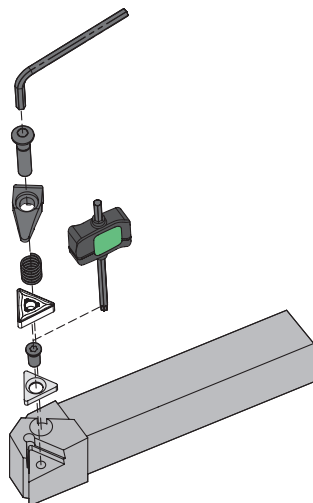

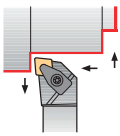
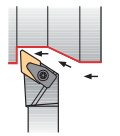
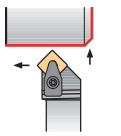
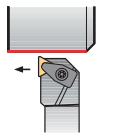
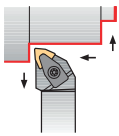
<p>DCLN 95°</p>  <p>PAGE C - 542 CN.. 1204.. CN.. 1906..</p>	<p>DDJN 93°</p>  <p>PAGE C - 543 DN.. 1104.. DN.. 1506..</p>	<p>DSSN 45°</p>  <p>PAGE C - 544 SN.. 1204.. SN.. 1906..</p>	<p>DTGN 90°</p>  <p>PAGE C - 545 TN.. 1604.. TN.. 2204..</p>	<p>DWLN 95°</p>  <p>PAGE C - 546 WN.. 0604.. WN.. 0804..</p>
--	--	--	--	--

(D) DIMPLE LOCK TOOLHOLDERS

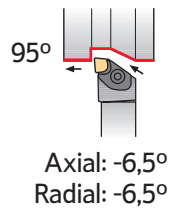

Roughing	Finishing	Medium to Finishing	Medium to Finishing	Medium	Medium	Medium
Flat (12-19)	MF (12)	SF (12)	LC (12)	MS (12)	MR (12-19)	PM (12)
Medium	Medium Wiper	Roughing to Medium	Roughing	Roughing	Heavy to Roughing	Heavy to Roughing
ST (12-19)	MW (12)	SS (12-19)	HR (12-19)	RP (19)	HY (19)	HZ (19)

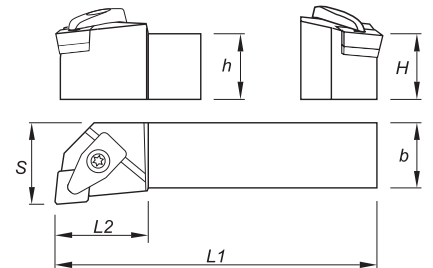

Order Code		Reference	Dimensions (mm)					Insert	Kg	Stock	
R	L		H=h	b	L1	L2	S			R	L
212275500	212275600	DCLN R/L 2020 K12	20	20	125	28	25	CN.. 1204..	0,400		
212219600	212246600	DCLN R/L 2525 M12	25	25	150	28	32	CN.. 1204..	0,750		
212275700	212249200	DCLN R/L 3232 P12	32	32	170	28	40	CN.. 1204..	1,300		
212275800	212275900	DCLN R/L 3232 P19	32	32	170	42	40	CN.. 1906..	1,300		
212276000	212276100	DCLN R/L 4040 S19	40	40	250	45	50	CN.. 1906..	3,050		















Stock Items | Itens de stock

Available under request | Disponível sob consulta | Disponible bajo consulta







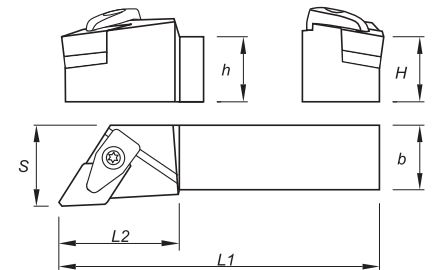
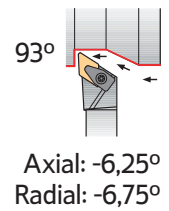

SPARE PARTS | Complementos | Repuestos

Cutter Reference	Shim 	Shim Screw 	Spring 	Clamp 	Clamp Screw 	Wrench
DCLN R/L 2020 K12	CC120600	T06010000	M09513	GA07002	D0602900	SS40
DCLN R/L 2525 M12	CC120600	T06010000	M09513	GA07002	D0602900	SS40
DCLN R/L 3232 P12	CC120600	T06010000	M09513	GA07002	D0602900	SS40
DCLN R/L 3232 P19	CC190502	T06015000	M09513	GA07003	D0602900	SS40
DCLN R/L 4040 S19	CC190502	T06015000	M09513	GA07003	D0602900	SS40

(D) DIMPLE LOCK TOOLHOLDERS

Roughing	Finishing	Medium to Finishing	Medium to Finishing	Medium	Medium	Medium	Medium
Flat	MF	SF	LC	MS	MR	PM	ST
 (11-15)	 (11-15)	 (11-15)	 (15)	 (15)	 (11-15)	 (15)	 (11-15)
Medium Wiper	Roughing to Medium	Roughing	Roughing	Roughing to Medium	Medium to Finishing	Medium to Finishing	
MW	SS	HR	RP	O1	O2	O3	
 (15)	 (11-15)	 (15)	 (15)	 (15)	 (15)	 (15)	









Order Code		Reference	Dimensions (mm)					Insert	Kg	Stock	
R	L		H=h	b	L1	L2	S			R	L
212422900	212423000	DDJN R/L 2020 K11	20	20	125	34	25,0	DN.. 1104..	0,400		
212065900	212276200	DDJN R/L 2020 K15	20	20	125	34	25	DN.. 1506..	0,400		
212219300	212168000	DDJN R/L 2525 M15	25	25	150	34	32	DN.. 1506..	0,750		
212276300	212249400	DDJN R/L 3232 P15	32	32	170	34	40	DN.. 1506..	1,300		











 Stock Items | Itens de stock

 Available under request | Disponível sob consulta | Disponible bajo consulta









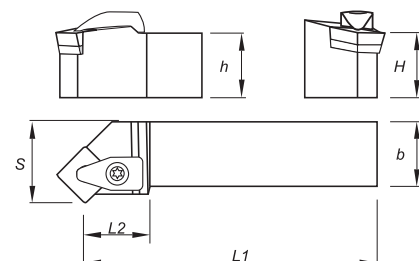
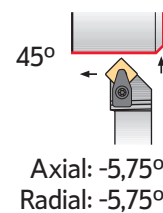

SPARE PARTS | Complementos | Repuestos

Cutter Reference	Shim	Shim Screw	Spring	Clamp	Clamp Screw	Wrench
						
DDJN R/L 2020 K11	CD110302	D0500801	M06511	GA05001	T05008000	SS40
DDJN R/L 2020 K15	CD150501	T06010000	M09513	GA07002	D0602900	SS40
DDJN R/L 2525 M15	CD150501	T06010000	M09513	GA07002	D0602900	SS40
DDJN R/L 3232 P15	CD150501	T06010000	M09513	GA07002	D0602900	SS40

(D) DIMPLE LOCK TOOLHOLDERS































Roughing	Finishing	Medium	Medium	Medium	Medium
Flat  (12-19)	MF  (12)	SF  (12)	MR  (12-19)	PM  (12)	ST  (12-19)
Roughing to Medium	Roughing	Roughing	Heavy to Roughing	Heavy to Roughing	
SS  (12-19)	HR  (12-19)	RP  (19)	HY  (19)	HZ  (19)	













Order Code		Reference	Dimensions (mm)					Insert	Kg	Stock	
R	L		H=h	b	L1	L2	S			R	L
212066000	212276400	DSSN R/L 2020 K12	20	20	125	28	25	SN.. 1204..	0,400		
212245800	212276500	DSSN R/L 2525 M12	25	25	150	28	32	SN.. 1204..	0,750		
212276600	212276700	DSSN R/L 3225 P12	32	25	170	28	32	SN.. 1204..	1,050		
212276800	212276900	DSSN R/L 3232 P19	32	32	170	42	40	SN.. 1906..	1,300		
212277000	212277100	DSSN R/L 4040 S19	40	40	250	45	50	SN.. 1906..	3,050		

 Stock Items | Itens de stock  Available under request | Disponível sob consulta | Disponible bajo consulta  Stock available until sold out | Stock disponível até acabar o stock | Stock disponible hasta acabar el stock







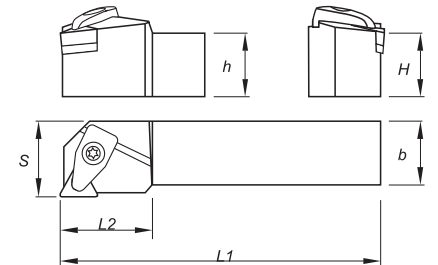
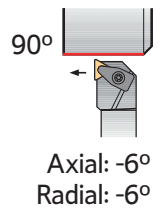

SPARE PARTS || Complementos | Repuestos

Cutter Reference	Shim	Shim Screw	Spring	Clamp	Clamp Screw	Wrench
DSSN R/L 2020 K12	 CS120600	 T06010000	 M09513	 GA07002	 D0602900	 SS40
DSSN R/L 2525 M12	 CS120600	 T06010000	 M09513	 GA07002	 D0602900	 SS40
DSSN R/L 3225 P12	 CS120600	 T06010000	 M09513	 GA07002	 D0602900	 SS40
DSSN R/L 3232 P19	 CS190501	 T06015000	 M09513	 GA07003	 D0602900	 SS40
DSSN R/L 4040 S19	 CS190400	 P0801411	 M09513	 GA07001	 D0702800	 SS40

(D) DIMPLE LOCK TOOLHOLDERS

Roughing	Finishing	Medium to Finishing	Medium to Finishing	Medium	Medium
Flat	MF	SF	LC	MS	MR
 (16-22)	 (16-22)	 (16-22)	 (16-22)	 (16)	 (16-22)
Medium	Medium	Roughing to Medium	Roughing	Medium to Finishing	
PM	ST	SS	HR	O1	
 (16-22)	 (16-22)	 (16-22)	 (16-22)	 (16)	



























Order Code		Reference	Dimensions (mm)					Insert	Kg	Stock	
R	L		H=h	b	L1	L2	S			R	L
212277200	212277300	DTGN R/L 2020 K16	20	20	125	28	25	TN.. 1604..	0,400		
212219500	212277400	DTGN R/L 2525 M16	25	25	150	28	32	TN.. 1604..	0,750		
212277500	212277600	DTGN R/L 2525 M22	25	25	150	34	32	TN.. 2204..	0,750		
212277700	212277800	DTGN R/L 3232 P22	32	32	170	34	40	TN.. 2204..	1,300		

 Stock Items | Itens de stock

 Available under request | Disponivel sob consulta | Disponible bajo consulta

SPARE PARTS | Complementos | Repuestos

Cutter Reference	Shim	Shim Screw	Spring	Clamp	Clamp Screw	Wrench
DTGN R/L 2020 K16	 CT160600	 T05008000	 M06511	 GA05001	 D0500801	 SS40
DTGN R/L 2525 M16	 CT160600	 T05008000	 M06511	 GA05001	 D0500801	 SS40
DTGN R/L 2525 M22	 CT220600	 T06010000	 M09513	 GA07002	 D0602900	 SS40
DTGN R/L 3232 P22	 CT220600	 T06010000	 M09513	 GA07002	 D0602900	 SS40

(D) DIMPLE LOCK TOOLHOLDERS

Roughing	Finishing	Medium to Finishing	Medium to Finishing	Medium to Finishing	Medium
Flat (06-08)	MF (06-08)	SF (06-08)	LC (08)	MS (06-08)	PM (06-08)
Medium	Medium	Medium Wiper	Roughing to Medium	Roughing	
MR (06-08)	ST (08)	MW (06-08)	SS (06-08)	HR (08)	

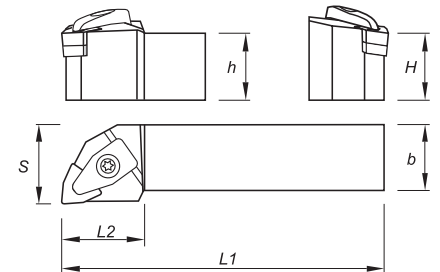
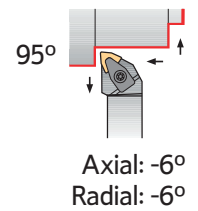

Order Code		Reference	Dimensions (mm)					Insert	Kg	Stock	
R	L		H=h	b	L1	L2	S			R	L
212425100	212425200	DWLN R/L 2020 K06	20	20	125	34	25	WN.. 0604..	0,400		
212425300	212425400	DWLN R/L 2525 M06	25	25	150	34	25	WN.. 0604..	0,400		
212277900	212278000	DWLN R/L 2020 K08	20	20	125	34	25	WN.. 0804..	0,400		
212219400	212246300	DWLN R/L 2525 M08	25	25	150	34	32	WN.. 0804..	0,750		
212278100	212278200	DWLN R/L 3232 P08	32	32	170	34	40	WN.. 0804..	1,300		

Stock Items | Itens de stock

Available under request | Disponível sob consulta | Disponible bajo consulta

SPARE PARTS | Complementos | Repuestos

Cutter Reference	Shim	Shim Screw	Spring	Clamp	Clamp Screw	Wrench
DWLN R/L 2020 K06						
DWLN R/L 2525 M06	CW060302	T05008000	M06511	GA05001	T05008000	SS40
DWLN R/L 2020 K08	CW080500	T06010000	M09513	GA07002	D0602900	SS40
DWLN R/L 2525 M08	CW080500	T06010000	M09513	GA07002	D0602900	SS40
DWLN R/L 3232 P08	CW080500	T06010000	M09513	GA07002	D0602900	SS40

(M) WEDGE CLAMP SYSTEM

(M-K) DOUBLE LOCK SYSTEM

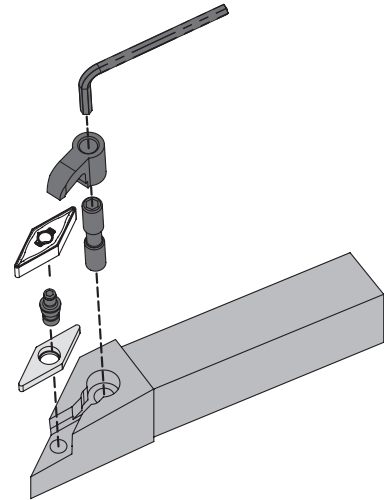
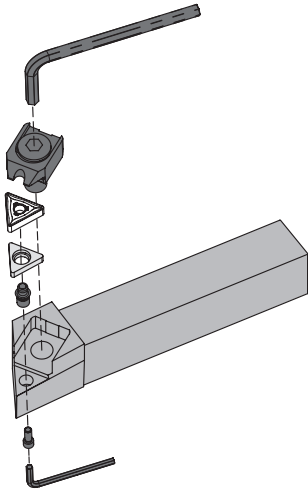

MCLN 95° PAGE C - 548 CN.. 1204.. CN.. 1906..	MCLN-K 95° PAGE C - 549 CN.. 1204.. CN.. 1906..	MDJN-K 93° PAGE C - 550 DN.. 1506..	MSSN-K 45° PAGE C - 551 SN.. 1204..	MSSN 45° PAGE C - 552 SN.. 1204.. SN.. 1906..	MTEN 60° PAGE C - 553 TN.. 1604.. TN.. 2204..
MTJN 93° PAGE C - 554 TN.. 1604.. TN.. 2204..	MTJN-K 93° PAGE C - 555 TN.. 1604.. TN.. 2204..	MTNN 63° PAGE C - 556 TN.. 1604.. TN.. 2204..	MVJN-K 93° PAGE C - 557 VN.. 1604..	MVQN-K 117°30' PAGE C - 558 VN.. 1604..	MVVN-K 72°30' PAGE C - 559 VN.. 1604..
MWLN 95° PAGE C - 560 WN.. 0604.. WN.. 0804..	MWLN-K 95° PAGE C - 561 WN.. 0804..				

(M) WEDGE CLAMP SYSTEM

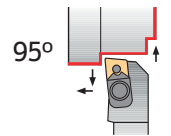

Axial: -8°
Radial: -6,5°

Roughing	Finishing	Medium to Finishing	Medium to Finishing	Medium	Medium	Medium
Flat ST (12-19)	MF (12)	SF (12)	LC (12)	MS (12)	MR (12-19)	PM (12)
Medium	Medium Wiper	Roughing to Medium	Roughing	Roughing	Heavy to Roughing	Heavy to Roughing
ST (12-19)	MW (12)	SS (12-19)	HR (12-19)	RP (19)	HY (19)	HZ (19)

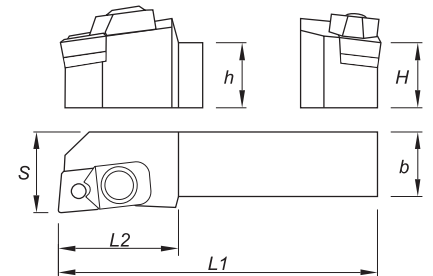

Order Code		Reference	Dimensions (mm)					Insert	Kg	Stock	
R	L		H=h	b	L1	L2	S			R	L
212245900	212278300	MCLN R/L 2020 K12	20	20	125	34	25	CN.. 1204..	0,450		
212246000	212010500	MCLN R/L 2525 M12	25	25	150	34	32	CN.. 1204..	0,800		
212278400	212278500	MCLN R/L 3225 P12	32	25	170	34	32	CN.. 1204..	1,200		
212278600	212278700	MCLN R/L 2525 M19	25	25	150	42	32	CN.. 1906..	0,800		
212278800	212278900	MCLN R/L 3225 P19	32	25	170	42	32	CN.. 1906..	1,200		
212279000	212279100	MCLN R/L 4040 S19	40	40	250	42	50	CN.. 1906..	3,100		















Stock Items | Itens de stock

Available under request | Disponível sob consulta | Disponible bajo consulta









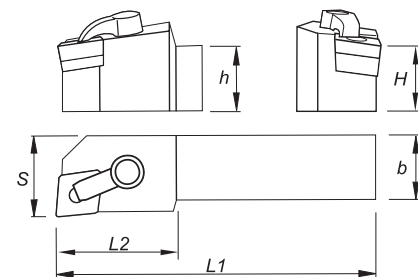
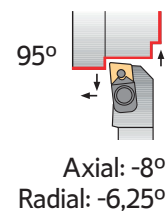

SPARE PARTS | Complementos | Repuestos

Cutter Reference	Shim	Lock Pin	lock Pin Screw	Wedge Clamp	Wrench
MCLN R/L 2020 K12	CC120500	BC06000	D0400900	GW08002	SS50
MCLN R/L 2525 M12	CC120500	BC06000	D0400900	GW08002	SS50
MCLN R/L 3225 P12	CC120500	BC06000	D0400900	GW08002	SS50
MCLN R/L 2525 M19	CC190500	BC08000	D0602200	GW08003	SS50
MCLN R/L 3225 P19	CC190500	BC08000	D0602200	GW08003	SS50
MCLN R/L 4040 S19	CC190500	BC08000	D0602200	GW08003	SS50

(M-K) DOUBLE LOCK SYSTEM

Roughing	Finishing	Medium to Finishing	Medium to Finishing	Medium	Medium	Medium
Flat  (12-19)	MF  (12)	SF  (12)	LC  (12)	MS  (12)	MR  (12-19)	PM  (12)
Medium	Medium Wiper	Roughing to Medium	Roughing	Roughing	Heavy to Roughing	Heavy to Roughing
ST  (12-19)	MW  (12)	SS  (12-19)	HR  (12-19)	RP  (19)	HY  (19)	HZ  (19)

































Order Code		Reference	Dimensions (mm)					Insert	Kg	Stock	
R	L		H=h	b	L1	L2	S			R	L
212286200	212286300	MCLN R/L 2020 K12-K	20	20	125	28	25	CN.. 1204..	0,450		
212286400	212286500	MCLN R/L 2525 M12-K	25	25	150	28	32	CN.. 1204..	0,800		
212286600	212286700	MCLN R/L 3225 P12-K	32	25	170	28	32	CN.. 1204..	1,200		
212286800	212286900	MCLN R/L 2525 M19-K	25	25	150	42	32	CN.. 1906..	0,800		
212287000	212287100	MCLN R/L 3232 P19-K	32	32	170	42	40	CN.. 1906..	1,400		

 Stock Items | Itens de stock

 Available under request | Disponível sob consulta | Disponible bajo consulta



SPARE PARTS | Complementos | Repuestos

Cutter Reference	Shim	Lock Pin	Lock Pin Wrench	Clamp	Differential Screw	Clamp Wrench
MCLN R/L 2020 K12-K	 CC120500	 BS1-400	 SS25	 GA06000	 F0602900	 SS30
MCLN R/L 2525 M12-K	 CC120500	 BS1-400	 SS25	 GA06000	 F0602900	 SS30
MCLN R/L 3225 P12-K	 CC120500	 BS1-400	 SS25	 GA06000	 F0602900	 SS30
MCLN R/L 2525 M19-K	 CC190502	 BS3-800	 SS40	 GA06003	 F0802900	 SS40
MCLN R/L 3232 P19-K	 CC190502	 BS3-800	 SS40	 GA06003	 F0802900	 SS40

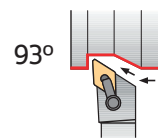



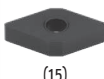
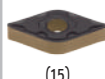
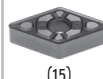
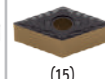
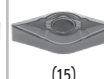
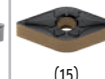

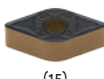
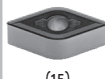
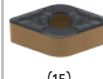
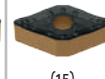
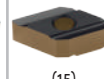
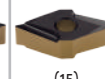
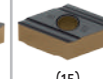
(M-K) DOUBLE LOCK SYSTEM

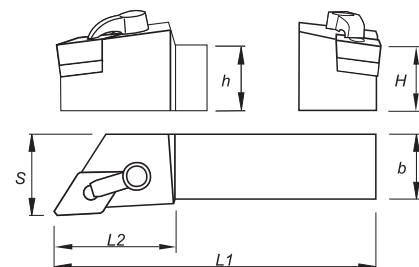

Axial: -6°
Radial: -7°

Roughing	Finishing	Medium to Finishing	Medium to Finishing	Medium	Medium	Medium	Medium
Flat	MF	SF	LC	MS	MR	PM	ST
 (15)	 (15)	 (15)	 (15)	 (15)	 (15)	 (15)	 (15)
Medium Wiper	Roughing to Medium	Roughing	Roughing	Roughing to Medium	Medium to Finishing	Medium to Finishing	
MW	SS	HR	RP	O1	O2	O3	
 (15)	 (15)	 (15)	 (15)	 (15)	 (15)	 (15)	









Order Code		Reference	Dimensions (mm)					Insert	Kg	Stock	
R	L		H=h	b	L1	L2	S			R	L
212287200	212287300	MDJN R/L 2020 K15-K	20	20	125	34	25	DN.. 1506..	0,450		
212287400	212287500	MDJN R/L 2525 M15-K	25	25	150	34	32	DN.. 1506..	0,800		
212287600	212287700	MDJN R/L 3225 P15-K	32	25	170	34	32	DN.. 1506..	1,200		









 Stock Items | Itens de stock

 Available under request | Disponível sob consulta | Disponible bajo consulta





SPARE PARTS | Complementos | Repuestos

Cutter Reference	Shim	Lock Pin	Lock Pin Wrench	Clamp	Differential Screw	Clamp Wrench
						
MDJN R/L 2020 K15-K	CD150501	BS1-401	SS25	GA06001	F0602900	SS30
MDJN R/L 2525 M15-K	CD150501	BS1-401	SS25	GA06001	F0602900	SS30
MDJN R/L 3225 P15-K	CD150501	BS1-401	SS25	GA06001	F0602900	SS30

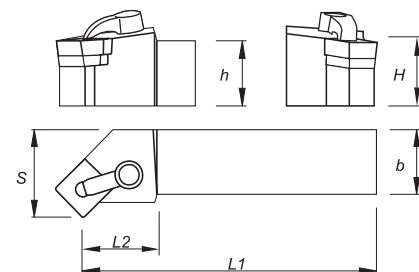
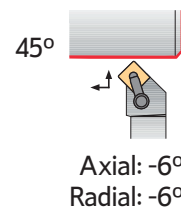
(M-K) DOUBLE LOCK SYSTEM

Roughing	Finishing	Medium to finishing	Medium
Flat  (12)	MF  (12)	SF  (12)	MR  (12)
Medium	Medium	Roughing to Medium	Roughing
PM  (12)	ST  (12)	SS  (12)	HR  (12)









Order Code		Reference	Dimensions (mm)					Insert	Kg	Stock	
R	L		H=h	b	L1	L2	S			R	L
212287800	212287900	MSSN R/L 2020 K12-K	20	20	125	28	27	SN.. 1204..	0,450		
212288000	212288100	MSSN R/L 2525 M12-K	25	25	150	28	32	SN.. 1204..	0,800		

 Stock Items | Itens de stock

 Available under request | Disponível sob consulta | Disponible bajo consulta







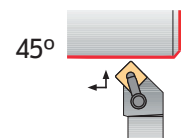



SPARE PARTS | Complementos | Repuestos

Cutter Reference	Shim 	Lock Pin 	Lock Pin Wrench 	Clamp 	Differential Screw 	Clamp Wrench 
MSSN R/L 2020 K12-K	CS120500	BS1-400	SS25	GA06000	F0602900	SS30
MSSN R/L 2525 M12-K	CS120500	BS1-400	SS25	GA06000	F0602900	SS30









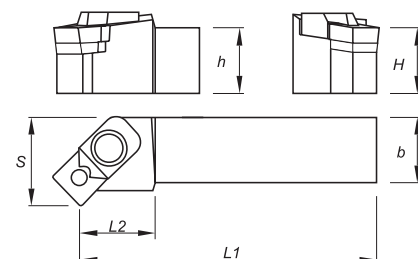





(M) WEDGE CLAMP SYSTEM



Axial: -6°
Radial: -6°

Roughing	Finishing	Medium	Medium	Medium	Medium
Flat  (12-19)	MF  (12)	SF  (12)	MR  (12-19)	PM  (12)	ST  (12-19)
Roughing to Medium	Roughing	Roughing	Heavy to Roughing	Heavy to Roughing	
SS  (12-19)	HR  (12-19)	RP  (19)	HY  (19)	HZ  (19)	







Order Code		Reference	Dimensions (mm)					Insert	Kg	Stock	
R	L		H=h	b	L1	L2	S			R	L
212279200	212279300	MSSN R/L 2020 K12	20	20	125	34	27	SN.. 1204..	0,450		
212279400	212279500	MSSN R/L 2525 M12	25	25	150	34	32	SN.. 1204..	0,800		
212279600	212279700	MSSN R/L 3225 P12	32	25	170	34	32	SN.. 1204..	1,200		
212279800	212279900	MSSN R/L 2525 M19	25	25	150	42	32	SN.. 1906..	0,800		
212280000	212280100	MSSN R/L 3225 P19	32	25	170	42	32	SN.. 1906..	1,200		
212280200	212280300	MSSN R/L 3232 P19	32	32	170	42	40	SN.. 1906..	1,400		
212280400	212280500	MSSN R/L 4040 S19	40	40	250	42	50	SN.. 1906..	3,100		











 Stock Items | Itens de stock

 Available under request | Disponível sob consulta | Disponible bajo consulta









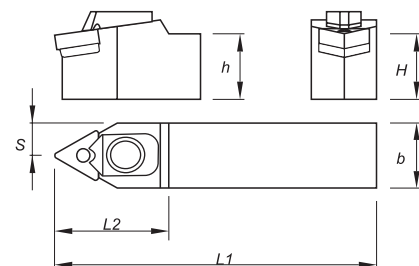
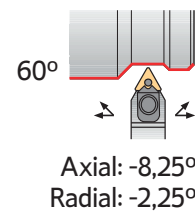















SPARE PARTS || Complementos | Repuestos

Cutter Reference	Shim 	Lock Pin 	Lock Pin Screw 	Wedge Clamp 	Wrench 
MSSN R/L 2020 K12	CS120400	BC06000	D0400900	GW08001	SS50
MSSN R/L 2525 M12	CS120400	BC06000	D0400900	GW08001	SS50
MSSN R/L 3225 P12	CS120400	BC06000	D0400900	GW08001	SS50
MSSN R/L 2525 M19	CS190400	BC08000	D0601400	GW08003	SS50
MSSN R/L 3225 P19	CS190400	BC08000	D0601400	GW08003	SS50
MSSN R/L 3232 P19	CS190400	BC08000	D0601400	GW08003	SS50
MSSN R/L 4040 S19	CS190400	BC08000	D0601400	GW08003	SS50

(M) WEDGE CLAMP SYSTEM

Roughing	Finishing	Medium to Finishing	Medium to Finishing	Medium	Medium
Flat	MF	SF	LC	MS	MR
 (16-22)	 (16-22)	 (16-22)	 (16-22)	 (16)	 (16-22)
Medium	Medium	Roughing to Medium	Roughing	Medium to Finishing	
PM	ST	SS	HR	O1	
 (16-22)	 (16-22)	 (16-22)	 (16-22)	 (16)	







Order Code		Reference	Dimensions (mm)					Insert	Kg	Stock	
R	L		H=h	b	L1	L2	S			R	L
212280600	212280700	MTEN R/L 2020 K16	20	20	125	34	10,5	TN.. 1604..	0,450		
212054800	212280900	MTEN R/L 2525 M16	25	25	150	34	13,0	TN.. 1604..	0,800		
212281000	212281100	MTEN R/L 3225 P16	32	25	170	34	13,0	TN.. 1604..	1,200		
212168800	212281300	MTEN R/L 2525 M22	25	25	150	42	13,0	TN.. 2204..	0,800		
212281500	212281600	MTEN R/L 3225 P22	32	25	170	42	13,0	TN.. 2204..	1,200		
212281800	212281900	MTEN R/L 3232 P22	32	32	170	42	16,5	TN.. 2204..	1,400		
212282100	212282200	MTEN R/L 4025 R22	40	25	200	42	13,0	TN.. 2204..	1,500		
212282400	212282500	MTEN R/L 5032 S22	50	32	250	45	16,5	TN.. 2204..	2,950		
212280800		MTEN N 2020 K16	20	20	125	34	10,5	TN.. 1604..	0,450		
212169700		MTEN N 2525 M16	25	25	150	34	13,0	TN.. 1604..	0,800		
212281200		MTEN N 3225 P16	32	25	170	34	13,0	TN.. 1604..	1,200		
212281400		MTEN N 2525 M22	25	25	150	42	13,0	TN.. 2204..	0,800		
212281700		MTEN N 3225 P22	32	25	170	42	13,0	TN.. 2204..	1,200		
212282000		MTEN N 3232 P22	32	32	170	42	16,5	TN.. 2204..	1,400		
212282300		MTEN N 4025 R22	40	25	200	42	13,0	TN.. 2204..	1,500		
212282600		MTEN N 5032 S22	50	32	250	45	16,5	TN.. 2204..	2,950		

 Stock Items | Itens de stock

 Available under request | Disponível sob consulta | Disponible bajo consulta









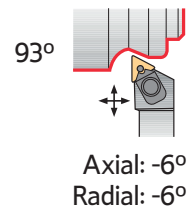



SPARE PARTS || Complementos | Repuestos

Cutter Reference	Shim	Lock Pin	Lock Pin Screw	Wedge Clamp	Wrench
					
MTEN R/L/N 2020 K16	CT160302	BC04500	D0300700	GW08001	SS50
MTEN R/L/N 2525 M16	CT160302	BC04500	D0300700	GW08001	SS50
MTEN R/L/N 3225 P16	CT160302	BC04500	D0300700	GW08001	SS50
MTEN R/L/N 2525 M22	CT220500	BC06000	D0400900	GW08003	SS50
MTEN R/L/N 3225 P22	CT220500	BC06000	D0400900	GW08003	SS50
MTEN R/L/N 3232 P22	CT220500	BC06000	D0400900	GW08003	SS50
MTEN R/L/N 4025 R22	CT220500	BC06000	D0400900	GW08003	SS50
MTEN R/L/N 5032 S22	CT220500	BC06000	D0400900	GW08003	SS50









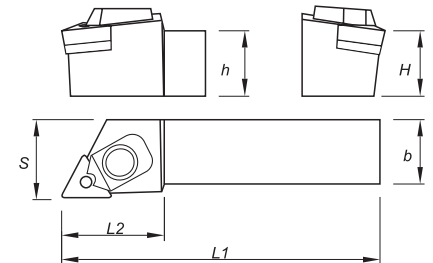







C
 TURNING
 Insert selection
 Overview
 Negative inserts
 Positive inserts
 PCBN & PCD inserts
 Heavy turning
 External Toolholders
 Internal Toolholders
 Automatic Lathes
 Spare Parts
 Technical Data

(M) WEDGE CLAMP SYSTEM



Roughing	Finishing	Medium to Finishing	Medium to Finishing	Medium	Medium
Flat	MF	SF	LC	MS	MR
 (16-22)	 (16-22)	 (16-22)	 (16-22)	 (16)	 (16-22)
Medium	Medium	Medium	Roughing to Medium	Roughing	Medium to Finishing
PM	ST	MW	SS	HR	O1
 (16-22)	 (16-22)	 (16-22)	 (16-22)	 (16-22)	 (16)







Order Code		Reference	Dimensions (mm)					Insert	Kg	Stock	
R	L		H=h	b	L1	L2	S			R	L
212054100	212282700	MTJN R/L 2020 K16	20	20	125	34	25	TN.. 1604..	0,450		
212026100	212047700	MTJN R/L 2525 M16	25	25	150	34	32	TN.. 1604..	0,800		
212010600	212282800	MTJN R/L 3225 P16	32	25	170	34	32	TN.. 1604..	1,200		
212282900	212283000	MTJN R/L 2525 M22	25	25	150	42	32	TN.. 2204..	0,800		
212283100	212283200	MTJN R/L 3225 P22	32	25	170	42	32	TN.. 2204..	1,200		
212283300	212283400	MTJN R/L 3232 P22	32	32	170	42	40	TN.. 2204..	1,400		
212283500	212283600	MTJN R/L 4025 R22	40	25	200	42	32	TN.. 2204..	1,500		
212010700	212283700	MTJN R/L 5032 S22	50	32	250	45	40	TN.. 2204..	2,950		













 Stock Items | Itens de stock

 Available under request | Disponível sob consulta | Disponible bajo consulta









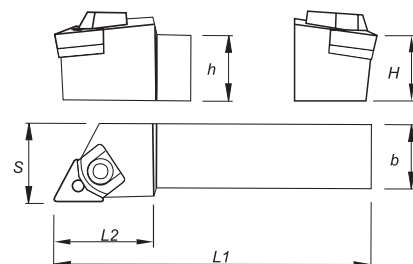
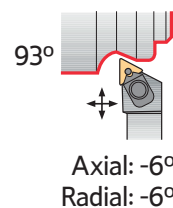





SPARE PARTS | Complementos | Repuestos

Cutter Reference	Shim	Lock Pin	Lock Pin Screw	Wedge Clamp	Wrench
MTJN R/L 2020 K16	 CT160302	 BC04500	 D0300700	 GW08001	 SS50
MTJN R/L 2525 M16	CT160302	BC04500	D0300700	GW08001	SS50
MTJN R/L 3225 P16	CT160302	BC04500	D0300700	GW08001	SS50
MTJN R/L 2525 M22	CT220500	BC06000	D0400900	GW08003	SS50
MTJN R/L 3225 P22	CT220500	BC06000	D0400900	GW08003	SS50
MTJN R/L 3232 P22	CT220500	BC06000	D0400900	GW08003	SS50
MTJN R/L 4025 R22	CT220500	BC06000	D0400900	GW08003	SS50
MTJN R/L 5032 S22	CT220500	BC06000	D0400900	GW08003	SS50

(M-K) DOUBLE LOCK SYSTEM

Roughing	Finishing	Medium to Finishing	Medium to Finishing	Medium	Medium
Flat	MF	SF	LC	MS	MR
 (16-22)	 (16-22)	 (16-22)	 (16-22)	 (16)	 (16-22)
Medium	Medium	Medium	Roughing to Medium	Roughing	Medium to Finishing
PM	ST	MW	SS	HR	O1
 (16-22)	 (16-22)	 (16-22)	 (16-22)	 (16-22)	 (16)





































Order Code		Reference	Dimensions (mm)					Insert	Kg	Stock	
R	L		H=h	b	L1	L2	S			R	L
212289300	212289400	MTJN R/L 2020 K16-K	20	20	125	22	25	TN.. 1604..	0,450		
212228600	212289500	MTJN R/L 2525 M16-K	25	25	150	22	32	TN.. 1604..	0,800		
212169600	212289600	MTJN R/L 2525 M22-K	25	25	150	28	32	TN.. 2204..	0,800		
212289700	212289800	MTJN R/L 3225 P22-K	32	25	170	28	32	TN.. 2204..	1,200		
212289900	212290000	MTJN R/L 3232 P22-K	32	32	170	28	40	TN.. 2204..	1,400		
212290100	212290200	MTJN R/L 4025 R22-K	40	25	200	34	32	TN.. 2204..	1,500		
212290300	212290400	MTJN R/L 5032 S22-K	50	32	250	34	40	TN.. 2204..	2,950		

 Stock Items | Itens de stock









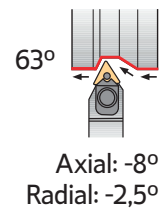

 Available under request | Disponível sob consulta | Disponible bajo consulta

SPARE PARTS || Complementos | Repuestos









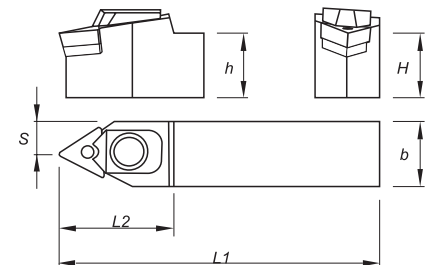







Cutter Reference	Shim	Lock Pin	Lock Pin Screw	Wedge Clamp	Wrench
MTJN R/L 2020 K16-K	 CT160302	 BC04500	 D0300700	 GW05001	 SS25
MTJN R/L 2525 M16-K	 CT160302	 BC04500	 D0300700	 GW05001	 SS25
MTJN R/L 2525 M22-K	 CT220500	 BC06000	 D0400900	 GW06001	 SS30
MTJN R/L 3225 P22-K	 CT220500	 BC06000	 D0400900	 GW06001	 SS30
MTJN R/L 3232 P22-K	 CT220500	 BC06000	 D0400900	 GW06001	 SS30
MTJN R/L 4025 R22-K	 CT220500	 BC06000	 D0400900	 GW06001	 SS30
MTJN R/L 5032 S22-K	 CT220500	 BC06000	 D0400900	 GW06001	 SS30

(M) WEDGE CLAMP SYSTEM



Roughing	Finishing	Medium to Finishing	Medium to Finishing	Medium	Medium
Flat	MF	SF	LC	MS	MR
 (16-22)	 (16-22)	 (16-22)	 (16-22)	 (16)	 (16-22)
Medium	Medium	Roughing to Medium	Roughing	Medium to Finishing	
PM	ST	SS	HR	O1	
 (16-22)	 (16-22)	 (16-22)	 (16-22)	 (16)	







Order Code		Reference	Dimensions (mm)					Insert	Kg	Stock	
R	L		H=h	b	L1	L2	S			R	L
212283800	212283900	MTNN R/L 2020 K16	20	20	125	34	10,0	TN.. 1604..	0,450		
212284000	212043900	MTNN R/L 2525 M16	25	25	150	34	12,5	TN.. 1604..	0,800		
212284100	212284200	MTNN R/L 3225 P16	32	25	170	34	12,5	TN.. 1604..	1,200		
212284300	212284400	MTNN R/L 2525 M22	25	25	150	42	12,5	TN.. 2204..	0,800		
212284500	212284600	MTNN R/L 3225 P22	32	25	170	42	12,5	TN.. 2204..	1,200		
212284700	212284800	MTNN R/L 3232 P22	32	32	170	42	16,0	TN.. 2204..	1,400		
212284900	212285000	MTNN R/L 4025 R22	40	25	200	42	12,5	TN.. 2204..	1,500		
212285100	212285200	MTNN R/L 5032 S22	50	32	250	45	16,0	TN.. 2204..	2,950		









 Stock items | Itens de stock

 Available under request | Disponível sob consulta | Disponible bajo consulta





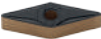
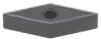

SPARE PARTS | Complementos | Repuestos

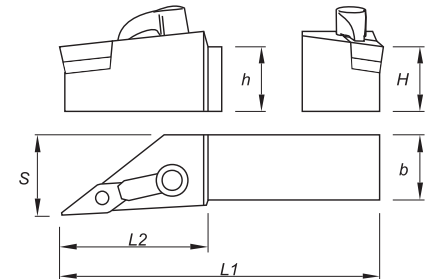
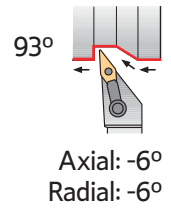
Cutter Reference	Shim	Lock Pin	Lock Pin Screw	Wedge Clamp	Wrench
MTNN R/L 2020 K16					
MTNN R/L 2525 M16	CT160302	BC04500	D0300700	GW08001	SS50
MTNN R/L 3225 P16	CT160302	BC04500	D0300700	GW08001	SS50
MTNN R/L 2525 M22	CT220500	BC06000	D0400900	GW08003	SS50
MTNN R/L 3225 P22	CT220500	BC06000	D0400900	GW08003	SS50
MTNN R/L 3232 P22	CT220500	BC06000	D0400900	GW08003	SS50
MTNN R/L 4025 R22	CT220500	BC06000	D0400900	GW08003	SS50
MTNN R/L 5032 S22	CT220500	BC06000	D0400900	GW08003	SS50

(M-K) DOUBLE LOCK SYSTEM

Roughing	Medium to Finishing	Medium to Finishing	Medium to Finishing	Medium to Finishing
Flat	MF	SF	LC	MS
 (16)	 (16)	 (16)	 (16)	 (16)
Medium	Medium	Medium	Roughing to Medium	
MR	PM	ST	SS	
 (16)	 (16)	 (16)	 (16)	

















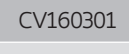



Order Code		Reference	Dimensions (mm)					Insert	Kg	Stock	
R	L		H=h	b	L1	L2	S			R	L
212050100	212057700	MVJN R/L 2020 K16-K	20	20	125	43	25	VN.. 1604..	0,450		
212246100	212288200	MVJN R/L 2525 M16-K	25	25	150	43	32	VN.. 1604..	0,800		
212288300	212288400	MVJN R/L 3225 P16-K	32	25	170	43	32	VN.. 1604..	1,200		

 Stock Items | Itens de stock

 Available under request | Disponível sob consulta | Disponible bajo consulta







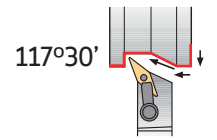

SPARE PARTS || Complementos | Repuestos

Cutter Reference	Shim	Lock Pin	Lock Pin Wrench	Clamp	Differential Screw	Clamp Wrench
MVJN R/L 2020 K16-K	 CV160301	 BS05000	 SS20	 GA06002	 F0602900	 SS30
MVJN R/L 2525 M16-K	 CV160301	 BS05000	 SS20	 GA06002	 F0602900	 SS30
MVJN R/L 3225 P16-K	 CV160301	 BS05000	 SS20	 GA06002	 F0602900	 SS30







(M-K) DOUBLE LOCK SYSTEM

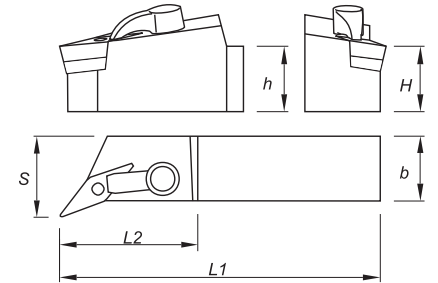

Axial: -8°
Radial: -10°

Roughing	Medium to Finishing	Medium to Finishing	Medium to Finishing	Medium to Finishing
Flat	MF	SF	LC	MS
 (16)	 (16)	 (16)	 (16)	 (16)
Medium	Medium	Medium	Roughing to Medium	
MR	PM	ST	SS	
 (16)	 (16)	 (16)	 (16)	

















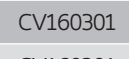



Order Code		Reference	Dimensions (mm)					Insert	Kg	Stock	
R	L		H=h	b	L1	L2	S			R	L
212288500	212288600	MVQN R/L 2020 K16-K	20	20	125	43	25	VN.. 1604..	0,450		
212288700	212288800	MVQN R/L 2525 M16-K	25	25	150	43	32	VN.. 1604..	0,800		
212288900	212289000	MVQN R/L 3225 P16-K	32	25	170	43	32	VN.. 1604..	1,200		

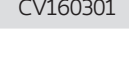







 Stock Items | Itens de stock

 Available under request | Disponível sob consulta | Disponible bajo consulta



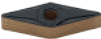
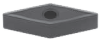

SPARE PARTS || Complementos | Repuestos

Cutter Reference	Shim	Lock Pin	Lock Pin Wrench	Clamp	Differential Screw	Clamp Wrench
MVQN R/L 2020 K16-K	 CV160301	 BS05000	 SS20	 GA06002	 F0602900	 SS30
MVQN R/L 2525 M16-K	 CV160301	 BS05000	 SS20	 GA06002	 F0602900	 SS30
MVQN R/L 3225 P16-K	 CV160301	 BS05000	 SS20	 GA06002	 F0602900	 SS30

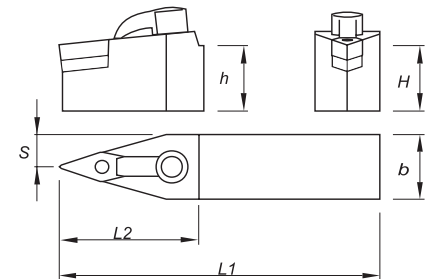
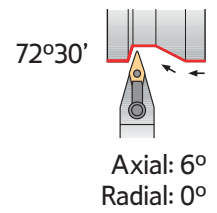
(M-K) DOUBLE LOCK SYSTEM

Roughing	Medium to Finishing	Medium to Finishing	Medium to Finishing	Medium to Finishing
Flat	MF	SF	LC	MS
 (16)	 (16)	 (16)	 (16)	 (16)
Medium	Medium	Medium	Roughing to Medium	
MR	PM	ST	SS	
 (16)	 (16)	 (16)	 (16)	















Order Code	Reference	Dimensions (mm)					Insert	Kg	Stock	
		H=h	b	L1	L2	S			R	L
212289100	MVVN N 2020 K16-K	20	20	125	43	10,0	VN..1604..	0,450		
212289200	MVVN N 2525 M16-K	25	25	150	43	12,5	VN..1604..	0,800		

 Stock Items | Itens de stock

 Available under request | Disponivel sob consulta | Disponible bajo consulta

SPARE PARTS || Complementos | Repuestos

Cutter Reference	Shim	Lock Pin	Lock Pin Wrench	Clamp	Differential Screw	Clamp Wrench
MVVN N 2020 K16-K	 CV160301	 BS05000	 SS20	 GA06002	 F0602900	 SS30
MVVN N 2525 M16-K	 CV160301	 BS05000	 SS20	 GA06002	 F0602900	 SS30

(M) WEDGE CLAMP SYSTEM

Roughing	Finishing	Medium to Finishing	Medium to Finishing	Medium	Medium
Flat (08)	MF (06-08)	SF (06-08)	LC (08)	MS (06-08)	PM (06-08)
Medium	Medium	Medium Wiper	Roughing to Medium	Roughing	
MR (06-08)	ST (08)	MW (06-08)	SS (06-08)	HR (08)	

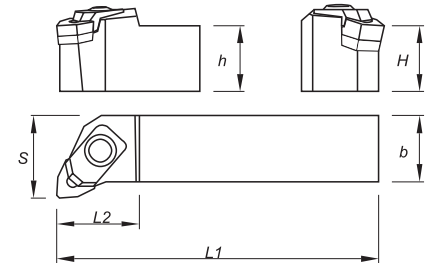
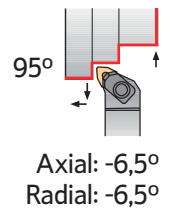











Order Code		Reference	Dimensions (mm)					Insert	Kg	Stock	
R	L		H=h	b	L1	L2	S			R	L
212285300	212285400	MWLN R/L 1616 H06	16	16	100	15	20	WN.. 0604..	0,200		
212048200	212285500	MWLN R/L 2020 K06	20	20	125	25	25	WN.. 0604..	0,450		
212285600	212285700	MWLN R/L 2525 M06	25	25	150	25	32	WN.. 0604..	0,800		
212246200	212285800	MWLN R/L 2020 K08	20	20	125	34	25	WN.. 0804..	0,450		
212054000	212042400	MWLN R/L 2525 M08	25	25	150	34	32	WN.. 0804..	0,800		
212285900	212286000	MWLN R/L 3225 P08	32	25	170	34	32	WN.. 0804..	1,200		
212010800	212286100	MWLN R/L 3232 P08	32	32	170	34	40	WN.. 0804..	1,400		

Stock Items | Itens de stock Available under request | Disponível sob consulta | Disponible bajo consulta





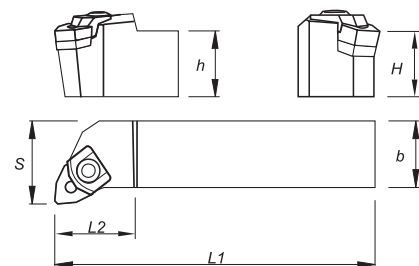
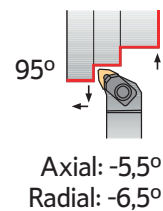

SPARE PARTS | Complementos | Repuestos

Cutter Reference	Shim	Lock Pin	Lock Pin Screw	Wedge Clamp	Wrench
MWLN R/L 1616 H06	CW060300	BC04501	D0300700	GW05000	SS25
MWLN R/L 2020 K06	CW060300	BC04500	D0300700	GW05000	SS25
MWLN R/L 2525 M06	CW060300	BC04500	D0300700	GW05000	SS25
MWLN R/L 2020 K08	CW080500	BC06000	D0400900	GW08000	SS50
MWLN R/L 2525 M08	CW080500	BC06000	D0400900	GW08000	SS50
MWLN R/L 3225 P08	CW080500	BC06000	D0400900	GW08000	SS50
MWLN R/L 3232 P08	CW080500	BC06000	D0400900	GW08000	SS50

(M-K) DOUBLE LOCK SYSTEM

Roughing	Finishing	Medium to Finishing	Medium to Finishing	Medium	Medium
Flat	MF	SF	LC	MS	PM
 (08)	 (08)	 (08)	 (08)	 (08)	 (08)
Medium	Medium	Medium Wiper	Roughing to Medium	Roughing	
MR	ST	MW	SS	HR	
 (08)	 (08)	 (08)	 (08)	 (08)	

















Order Code		Reference	Dimensions (mm)					Insert	Kg	Stock	
R	L		H=h	b	L1	L2	S			R	L
212290500	212290600	MWLN R/L 2020 K08-K	20	20	125	34	25	WN.. 0804..	0,450		
212250200	212290700	MWLN R/L 2525 M08-K	25	25	150	34	32	WN.. 0804..	0,800		
212290800	212290900	MWLN R/L 3232 P08-K	32	32	170	34	40	WN.. 0804..	1,400		

 Stock Items | Itens de stock

 Available under request | Disponível sob consulta | Disponible bajo consulta

SPARE PARTS || Complementos | Repuestos





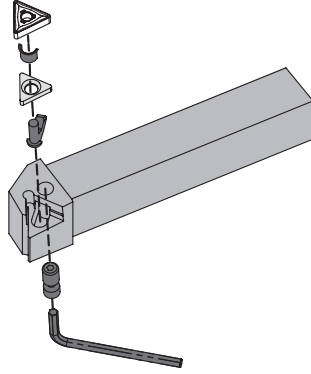







Cutter Reference	Shim	Lock Pin	Lock Pin Screw	Wedge Clamp	Wrench
MWLN R/L 2020 K08-K	 CW080500	 BC06000	 D0400900	 GW06000	 SS25
MWLN R/L 2525 M08-K	 CW080500	 BC06000	 D0400900	 GW06000	 SS25
MWLN R/L 3232 P08-K	 CW080500	 BC06000	 D0400900	 GW06000	 SS25

(P) LEVER LOCK SYSTEM









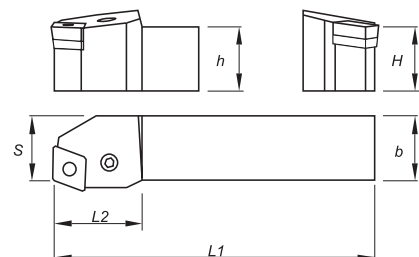
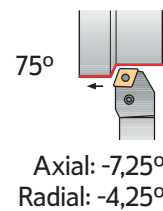















<p>PCBN 75°</p> <p>PAGE C - 563 CN.. 1204.. CN.. 1606.. CN.. 1906.. CN..2509..</p>	<p>PCFN 90°</p> <p>PAGE C - 564 CN.. 1204.. CN.. 1606.. CN.. 1906..</p>	<p>PCKN 75°</p> <p>PAGE C - 565 CN.. 1204... CN.. 1906.. CN.. 2506..</p>	<p>PCLN 95°</p> <p>PAGE C - 566 CN..0903.. ... CN..2509..</p>	<p>PCMN 50°</p> <p>PAGE C - 568 SN.. 1204.. SN.. 1906..</p>	<p>PCSN 45°</p> <p>PAGE C - 569 CN.. 1204.. CN.. 1606.. CN.. 1906..</p>
<p>PDJN 93°</p> <p>PAGE C - 570 DN.. 1104.. DN.. 1504.. DN.. 1506..</p>	<p>PDNN 63°</p> <p>PAGE C - 571 DN.. 1504.. DN.. 1506..</p>	<p>PRDC</p> <p>PAGE C - 572 RC.. 1003M0 ... RC.. 3209M0</p>	<p>PRSC</p> <p>PAGE C - 574 RC.. 10..32</p>	<p>PRSN</p> <p>PAGE C - 575 RN.. 09..25</p>	<p>PSBN 75°</p> <p>PAGE C - 576 SN.. 0903.. ... SN.. 2507..</p>
<p>PSDN 45°</p> <p>PAGE C - 577 SN.. 0903.. ... SN.. 2507..</p>	<p>PSKN 75°</p> <p>PAGE C - 578 SN.. 0903.. ... SN.. 2507..</p>	<p>PSSN 45°</p> <p>PAGE C - 579 SN.. 0903.. ... SN.. 2507..</p>	<p>PTDN 45°</p> <p>PAGE C - 580 TN.. 2204..</p>	<p>PTFN 90°</p> <p>PAGE C - 581 TN.. 1604.. TN.. 2204.. TN.. 2706..</p>	<p>PTGN 90°</p> <p>PAGE C - 582 TN.. 1604.. ... TN.. 3307..</p>
<p>PTTN 60°</p> <p>PAGE C - 583 TN.. 1604.. TN.. 2204..</p>	<p>PWLN 95°</p> <p>PAGE C - 584 WN.. 0604.. WN.. 0804..</p>				

(P) LEVER LOCK TOOLHOLDERS

Roughing	Finishing	Medium to Finishing	Medium to Finishing	Medium	Medium	Medium
Flat  (12-16-19)	MF  (12)	SF  (12)	LC  (12)	MS  (12)	MR  (12-16-19)	PM  (12)
Medium	Roughing to Medium	Roughing	Roughing	Heavy to Roughing	Heavy to Roughing	
ST  (12-16-19)	SS  (12-16-19)	HR  (12-16-19-25)	RP  (16-19)	HY  (19-25)	HZ  (19-25)	









Order Code		Reference	Dimensions (mm)					Insert	Kg	Stock	
R	L		H=h	b	L1	L2	S			R	L
212291000	212291100	PCBN R/L 2020 K12	20	20	125	28	17	CN.. 1204..	0,400		
212011200	212010900	PCBN R/L 2525 M12	25	25	150	28	22	CN.. 1204..	0,750		
212423100	212423200	PCBN R/L 3225 P12	32	25	170	34	22,0	CN.. 1204..	0,750		
212291200	212291300	PCBN R/L 2525 M16	25	25	150	34	22	CN.. 1606..	0,750		
212291400	212291500	PCBN R/L 3225 P16	32	25	170	34	22	CN.. 1606..	1,050		
212291600	212291700	PCBN R/L 3232 P16	32	32	170	34	27	CN.. 1606..	1,300		
212291800	212291900	PCBN R/L 3225 P19	32	25	170	42	22	CN.. 1906..	1,050		
212011300	212011000	PCBN R/L 3232 P19	32	32	170	42	27	CN.. 1906..	1,300		
212011400	212011100	PCBN R/L 4040 S19	40	40	250	45	35	CN.. 1906..	3,050		
212387900	212388000	PCBN R/L 4040 P25	40	40	250	48	41	CN.. 2509..	3,100		
212388100	212388200	PCBN R/L 5050 T25	50	50	300	50	51	CN.. 2509..	4,000		

 Stock Items | Itens de stock













 Available under request | Disponível sob consulta | Disponible bajo consulta

SPARE PARTS || Complementos | Repuestos









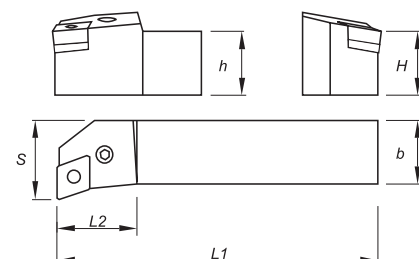
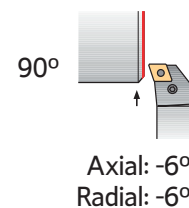





Cutter Reference	Order separately					
	Shim	Shim Pin	Shim Pin Punch	Lever	Lever Screw	Wrench
PCBN R/L 2020 K12						
PCBN R/L 2525 M12	CC120301	BE05500	BF47509	AN13100	PA0802100	SS30
PCBN R/L 3225 P12	CC120301	BE05500	BF47509	AN13100	PA0802100	SS30
PCBN R/L 2525 M16	CC160500	BE07000	BF65012	AN17100	PA0802300	SS30
PCBN R/L 3225 P16	CC160500	BE07000	BF65012	AN17100	PA0802300	SS30
PCBN R/L 3232 P16	CC160500	BE07000	BF65012	AN17100	PA0802300	SS30
PCBN R/L 3225 P19	CC190500	BE08500	BF80012	AN20800	PA1002700	SS40
PCBN R/L 3232 P19	CC190500	BE08500	BF80012	AN20800	PA1002700	SS40
PCBN R/L 4040 S19	CC190500	BE08500	BF80012	AN20800	PA1002700	SS40
PCBN R/L 4040 S25	CC250700	BE10500	BF12520	AN25200	PA1203600	SS50
PCBN R/L 5050 T25	CC250700	BE10500	BF12520	AN25200	PA1203600	SS50

TURNING
Insert selection
Overview
Negative inserts
Positive inserts
PCBN & PCD inserts
Heavy turning
External Toolholders
Internal Toolholders
Automatic Lathes
Spare Parts
Technical Data

(P) LEVER LOCK TOOLHOLDERS

Roughing	Finishing	Medium to Finishing	Medium to Finishing	Medium	Medium	Medium
Flat  (12-16-19)	MF  (12)	SF  (12)	LC  (12)	MS  (12)	MR  (12-16-19)	PM  (12)
Medium	Roughing to Medium	Roughing	Roughing	Heavy to Roughing	Heavy to Roughing	
ST  (12-16-19)	SS  (12-16-19)	HR  (12-16-19)	RP  (16-19)	HY  (19)	HZ  (19)	



Order Code		Reference	Dimensions (mm)					Insert	Kg	Stock	
R	L		H=h	b	L1	L2	S			R	L
212292000	212292100	PCFN R/L 2525 M12	25	25	150	28	32	CN..1204..	0,750		
212292200	212292300	PCFN R/L 2525 M16	25	25	150	34	32	CN..1606..	0,750		
212292400	212292500	PCFN R/L 3225 P16	32	25	170	34	32	CN..1606..	1,050		
212292600	212292700	PCFN R/L 3232 P16	32	32	170	34	40	CN..1606..	1,300		
212292800	212292900	PCFN R/L 3225 P19	32	25	170	42	32	CN..1906..	1,050		
212293000	212293100	PCFN R/L 3232 P19	32	32	170	42	40	CN..1906..	1,300		
212293200	212293300	PCFN R/L 4040 S19	40	40	250	45	50	CN..1906..	3,050		













 Stock Items | Itens de stock

 Available under request | Disponível sob consulta | Disponible bajo consulta









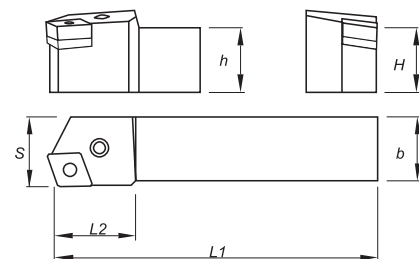
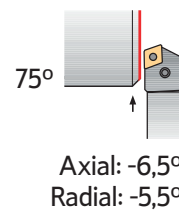





SPARE PARTS | Complementos | Repuestos

Cutter Reference	Order separately					
	Shim	Shim Pin	Shim Pin Punch	Lever	Lever Screw	Wrench
PCFN R/L 2525 M12	 CC120301	 BE05500	 BF47509	 AN13100	 PA0802100	 SS30
PCFN R/L 2525 M16	CC160500	BE07000	BF65012	AN17100	PA0802300	SS30
PCFN R/L 3225 P16	CC160500	BE07000	BF65012	AN17100	PA0802300	SS30
PCFN R/L 3232 P16	CC160500	BE07000	BF65012	AN17100	PA0802300	SS30
PCFN R/L 3225 P19	CC190500	BE08500	BF80012	AN20800	PA1002700	SS40
PCFN R/L 3232 P19	CC190500	BE08500	BF80012	AN20800	PA1002700	SS40
PCFN R/L 4040 S19	CC190500	BE08500	BF80012	AN20800	PA1002700	SS40

(P) LEVER LOCK TOOLHOLDERS

Roughing	Finishing	Medium to Finishing	Medium to Finishing	Medium	Medium	Medium
Flat  (12-19)	MF  (12)	SF  (12)	LC  (12)	MS  (12)	MR  (12-19)	PM  (12)
Medium	Roughing to Medium	Roughing	Roughing	Heavy to Roughing	Heavy to Roughing	
ST  (12-19)	SS  (12-19)	HR  (12-19-25)	RP  (19)	HY  (19-25)	HZ  (19-25)	









Order Code		Reference	Dimensions (mm)					Insert	Kg	Stock	
R	L		H=h	b	L1	L2	S			R	L
212011600	212293400	PCKN R/L 2020 K12	20	20	125	28	25	CN.. 1204..	0,400		
212011700	212293500	PCKN R/L 2525 M12	25	25	150	28	32	CN.. 1204..	0,750		
212293600	212011500	PCKN R/L 3225 P12	32	25	170	28	32	CN.. 1204..	1,050		
212293800	212293900	PCKN R/L 3232 P19	32	32	170	34	40	CN.. 1906..	1,300		
212294000	212294100	PCKN R/L 4040 S19	40	40	250	45	50	CN.. 1906..	3,050		
212294200	212294300	PCKN R/L 4040 S25	40	40	250	45	50	CN.. 2509..	3,050		
212294400	212294500	PCKN R/L 5050 T25	50	50	300	45	60	CN.. 2509..	5,850		













 Stock Items | Itens de stock

 Available under request | Disponível sob consulta | Disponible bajo consulta









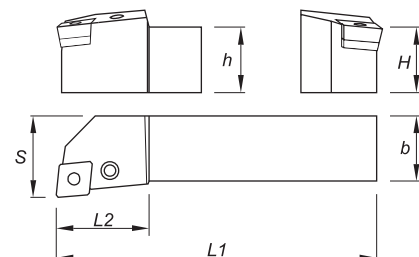
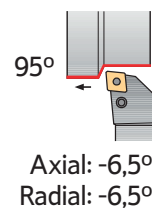





























SPARE PARTS | Complementos | Repuestos

Cutter Reference	Order separately					
	Shim 	Shim Pin 	Shim Pin Punch 	Lever 	Lever Screw 	Wrench 
PCKN R/L 2020 K12	CC120301	BE05500	BF47509	AN13100	PA0802100	SS30
PCKN R/L 2525 M12	CC120301	BE05500	BF47509	AN13100	PA0802100	SS30
PCKN R/L 3225 P12	CC120301	BE05500	BF47509	AN13100	PA0802100	SS30
PCKN R/L 3232 P19	CC190500	BE08500	BF80012	AN20800	PA1002700	SS40
PCKN R/L 4040 S19	CC190500	BE08500	BF80012	AN20800	PA1002700	SS40
PCKN R/L 4040 S25	CC250700	BE10500	BF12520	AN25200	PA1203600	SS50
PCKN R/L 5050 T25	CC250700	BE10500	BF12520	AN25200	PA1203600	SS50

(P) LEVER LOCK TOOLHOLDERS

Roughing	Finishing	Medium to Finishing	Medium to Finishing	Medium	Medium	Medium
Flat  (09-12-16-19)	MF  (09-12)	SF  (12)	LC  (12)	MS  (12)	MR  (09-12-16-19)	PM  (12)
Medium	Roughing to Medium	Roughing	Roughing	Heavy to Roughing	Heavy to Roughing	
ST  (09-12-16-19)	SS  (09-12-16-19)	HR  (12-16-19-25)	RP  (16-19)	HY  (19-25)	HZ  (19-25)	



Order Code		Reference	Dimensions (mm)					Insert	Kg	Stock	
R	L		H=h	b	L1	L2	S			R	L
212294600	212294700	PCLN R/L 1616 H09	16	16	100	25	20	CN.. 0903..	0,250		
212294800	212294900	PCLN R/L 2020 K09	20	20	125	27	25	CN.. 0903..	0,400		
212295000	212295100	PCLN R/L 2525 M09	25	25	150	27	32	CN.. 0903..	0,750		
212012300	212011800	PCLN R/L 1616 H12	16	16	100	26	20	CN.. 1204..	0,250		
212012400	212011900	PCLN R/L 2020 K12	20	20	125	28	25	CN.. 1204..	0,400		
212044800	212031500	PCLN R/L 2525 M12	25	25	150	28	32	CN.. 1204..	0,750		
212295200	212295300	PCLN R/L 3225 P12	32	25	170	28	32	CN.. 1204..	1,050		
212058200	212295400	PCLN R/L 3232 P12	32	32	170	28	40	CN.. 1204..	1,300		
212036400	212168100	PCLN R/L 2525 M16	25	25	150	34	32	CN.. 1606..	0,750		
212295500	212295600	PCLN R/L 3225 P16	32	25	170	34	32	CN.. 1606..	1,050		
212295700	212012100	PCLN R/L 3232 P16	32	32	170	34	40	CN.. 1606..	1,300		
212295800	212012200	PCLN R/L 4040 S16	40	40	250	34	50	CN.. 1606..	3,050		
212058100	212295900	PCLN R/L 2525 M19	25	25	150	42	32	CN.. 1906..	0,750		
212296000	212296100	PCLN R/L 3225 P19	32	25	170	42	32	CN.. 1906..	1,050		
212058300	212296200	PCLN R/L 3232 P19	32	32	170	42	40	CN.. 1906..	1,300		
212058400	212296300	PCLN R/L 4040 S19	40	40	250	45	50	CN.. 1906..	3,050		
212422700	212422800	PCLN R/L 5050 T19	50	50	300	50	60	CN.. 1906..	3,050		
212296400	212296500	PCLN R/L 4040 S25	40	40	250	45	50	CN.. 2509..	3,050		
212296600	212296700	PCLN R/L 5050 T25	50	50	300	45	60	CN.. 2509..	5,850		

 Stock Items | Itens de stock

 Available under request | Disponível sob consulta | Disponible bajo consulta

(P) LEVER LOCK TOOLHOLDERS

SPARE PARTS | Complementos | Repuestos

Cutter Reference	Order separately					
	Shim	Shim Pin	Shim Pin Punch	Lever	Lever Screw	Wrench
PCLN R/L 1616 H09	CC090300	BE04400	BF40009	AN01200	PA0601700	SS25
PCLN R/L 2020 K09	CC090300	BE04400	BF40009	AN01200	PA0601700	SS25
PCLN R/L 2525 M09	CC090300	BE04400	BF40009	AN01200	PA0601700	SS25
PCLN R/L 1616 H12	CC120301	BE05500	BF47509	AC13200	PA0801700	SS30
PCLN R/L 2020 K12	CC120301	BE05500	BF47509	AC13200	PA0802100	SS30
PCLN R/L 2525 M12	CC120301	BE05500	BF47509	AC13200	PA0802100	SS30
PCLN R/L 3225 P12	CC120301	BE05500	BF47509	AC13200	PA0802100	SS30
PCLN R/L 3232 P12	CC120301	BE05500	BF47509	AC13200	PA0802100	SS30
PCLN R/L 2525 M16	CC160500	BE07000	BF65012	AN17100	PA0802300	SS30
PCLN R/L 3225 P16	CC160500	BE07000	BF65012	AN17100	PA0802300	SS30
PCLN R/L 3232 P16	CC160500	BE07000	BF65012	AN17100	PA0802300	SS30
PCLN R/L 4040 S16	CC160500	BE07000	BF65012	AN17100	PA0802300	SS30
PCLN R/L 2525 M19	CC190500	BE08500	BF80012	AN20800	PA1002700	SS40
PCLN R/L 3225 P19	CC190500	BE08500	BF80012	AN20800	PA1002700	SS40
PCLN R/L 3232 P19	CC190500	BE08500	BF80012	AN20800	PA1002700	SS40
PCLN R/L 4040 S19	CC190500	BE08500	BF80012	AN20800	PA1002700	SS40
PCLN R/L 5050 T19	CC190500	BE08500	BF80012	AN20800	PA1002700	SS40
PCLN R/L 4040 S25	CC250700	BE10500	BF12520	AN25200	PA1203600	SS50
PCLN R/L 5050 T25	CC250700	BE10500	BF12520	AN25200	PA1203600	SS50



TURNING

Insert selection

Overview

Negative inserts

Positive inserts

PCBN & PCD inserts

Heavy turning

External Toolholders













Internal Toolholders

Automatic Lathes





Spare Parts

Technical Data

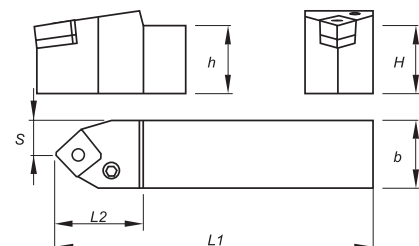
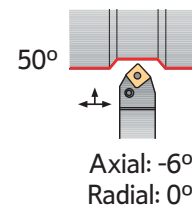
(P) LEVER LOCK TOOLHOLDERS

Roughing	Finishing	Medium to Finishing	Medium to Finishing	Medium	Medium	Medium
Flat  (12-19)	MF  (12)	SF  (12)	LC  (12)	MS  (12)	MR  (12-19)	PM  (12)
Medium	Roughing to Medium	Roughing	Roughing	Heavy to Roughing	Heavy to Roughing	
ST  (12-19)	SS  (12-19)	HR  (12-19)	RP  (19)	HY  (19)	HZ  (19)	









Order Code	Reference	Dimensions (mm)					Insert	Kg	Stock
		H=h	b	L1	L2	s			
212296800	PCMN N 2020 K12	20	20	125	34	10,0	CN.. 1204..	0,400	
212296900	PCMN N 2525 M12	25	25	150	34	12,5	CN.. 1204..	0,750	
212297000	PCMN N 3225 P12	32	25	170	34	12,5	CN.. 1204..	1,050	
212297100	PCMN N 3232 P19	32	32	170	42	16,0	CN.. 1906..	1,300	
212297200	PCMN N 4040 S19	40	40	250	42	20,0	CN.. 1906..	3,050	













 Stock Items | Itens de stock

 Available under request | Disponível sob consulta | Disponible bajo consulta









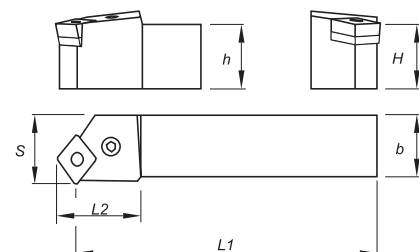
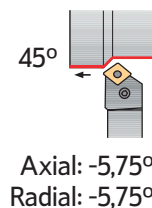







SPARE PARTS | Complementos | Repuestos

Cutter Reference	Order separately					
	Shim	Shim Pin	Shim Pin Punch	Lever	Lever Screw	Wrench
PCMN N 2020 K12						
PCMN N 2525 M12	CC120301	BE05500	BF47509	AN13100	A0802100	SS30
PCMN N 3225 P12	CC120301	BE05500	BF47509	AN13100	A0802100	SS30
PCMN N 3232 P19	CC190500	BE08500	BF80012	AN20800	A1002700	SS40
PCMN N 4040 S19	CC190500	BE08500	BF80012	AN20800	A1002700	SS40

(P) LEVER LOCK TOOLHOLDERS

Roughing	Finishing	Medium to Finishing	Medium to Finishing	Medium	Medium	Medium
Flat  (12-16-19)	MF  (12)	SF  (12)	LC  (12)	MS  (12)	MR  (12-16-19)	PM  (12)
Medium	Roughing to Medium	Roughing	Roughing	Heavy to Roughing	Heavy to Roughing	
ST  (12-19)	SS  (12-16-19)	HR  (12-16-19)	RP  (19)	HY  (19)	HZ  (19)	



















































Order Code		Reference	Dimensions (mm)					Insert	Kg	Stock	
R	L		H=h	b	L1	L2	S			R	L
212297300	212297400	PCSN R/L 2020 K12	20	20	125	28	25	CN.. 1204..	0,400		
212297500	212012800	PCSN R/L 2525 M12	25	25	150	28	32	CN.. 1204..	0,750		
212297600	212297700	PCSN R/L 2525 M16	25	25	150	34	32	CN.. 1606..	0,750		
212297800	212297900	PCSN R/L 3225 P16	32	25	170	34	32	CN.. 1606..	1,050		
212013100	212298000	PCSN R/L 3232 P16	32	32	170	34	40	CN.. 1606..	1,300		
212298100	212298200	PCSN R/L 3225 P19	32	25	170	42	32	CN.. 1906..	1,050		
212298300	212298400	PCSN R/L 3232 P19	32	32	170	42	40	CN.. 1906..	1,300		
212298500	212298600	PCSN R/L 4040 S19	40	40	250	45	50	CN.. 1906..	3,050		















 Stock Items | Itens de stock

 Available under request | Disponível sob consulta | Disponible bajo consulta









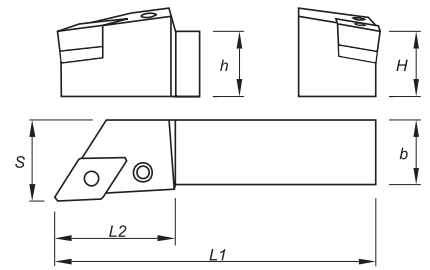
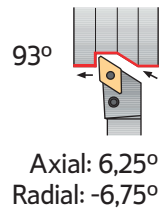











SPARE PARTS | Complementos | Repuestos

Cutter Reference	Order separately					
	Shim	Shim Pin	Shim Pin Punch	Lever	Lever Screw	Wrench
PCSN R/L 2020 K12	 CC120301	 BE05500	 BF47509	 AN13100	 PA0802100	 SS30
PCSN R/L 2525 M12	 CC120301	 BE05500	 BF47509	 AN13100	 PA0802100	 SS30
PCSN R/L 2525 M16	 CC160500	 BE07000	 BF65012	 AN17100	 PA0802300	 SS30
PCSN R/L 3225 P16	 CC160500	 BE07000	 BF65012	 AN17100	 PA0802300	 SS30
PCSN R/L 3232 P16	 CC160500	 BE07000	 BF65012	 AN17100	 PA0802300	 SS30
PCSN R/L 3225 P19	 CC190500	 BE08500	 BF80012	 AN20800	 PA1002700	 SS40
PCSN R/L 3232 P19	 CC190500	 BE08500	 BF80012	 AN20800	 PA1002700	 SS40
PCSN R/L 4040 S19	 CC190500	 BE08500	 BF80012	 AN20800	 PA1002700	 SS40

(P) LEVER LOCK TOOLHOLDERS

Roughing	Finishing	Medium to Finishing	Medium to Finishing	Medium	Medium	Medium	Medium
Flat	MF	SF	LC	MS	MR	PM	ST
 (11-15)	 (11-15)	 (11-15)	 (15)	 (15)	 (11-15)	 (15)	 (11-15)
Medium Wiper	Roughing to Medium	Roughing	Roughing	Roughing to Medium	Medium to Finishing	Medium to Finishing	
MW	SS	HR	RP	O1	O2	O3	
 (15)	 (11-15)	 (15)	 (15)	 (15)	 (15)	 (15)	

















Order Code		Reference	Dimensions (mm)					Insert	Kg	Stock	
R	L		H=h	b	L1	L2	S			R	L
212057800	212298700	PDJN R/L 1616 H11	16	16	100	28	20	DN.. 1104..	0,250		
212246900	212246800	PDJN R/L 2020 K11	20	20	125	28	25	DN.. 1104..	0,400		
212247500	212247600	PDJN R/L 2525 M11	25	25	150	28	32	DN.. 1104..	0,750		
212298800	212298900	PDJN R/L 3225 P11	32	25	170	28	32	DN.. 1104..	1,050		
212013600	212013200	PDJN R/L 2020 K15	20	20	125	34	25	DN.. 1506..	0,400		
212037300	212031600	PDJN R/L 2525 M15	25	25	150	34	32	DN.. 1506..	0,750		
212299000	212013400	PDJN R/L 3225 P15	32	25	170	34	32	DN.. 1506..	1,050		
212013800	212013500	PDJN R/L 3232 P15	32	32	170	34	40	DN.. 1506..	1,300		
212299100	212299200	PDJN R/L 4025 R15	40	25	200	34	32	DN.. 1506..	1,850		
212299300	212299400	PDJN R/L 5032 S15	50	32	250	34	40	DN.. 1506..	2,900		

 Stock Items | Itens de stock  Available under request | Disponível sob consulta | Disponible bajo consulta









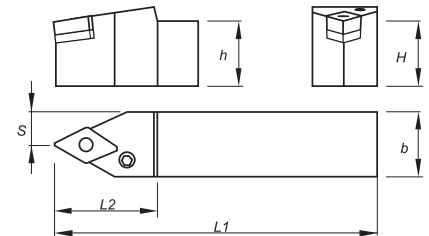
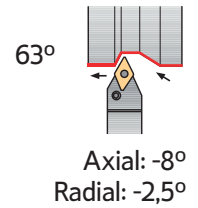







SPARE PARTS | Complementos | Repuestos

Cutter Reference	Order separately						for inserts DN. 1504..	
	Shim	Shim Pin	Shim Pin Punch	Lever	Lever Screw	Wrench	Shim	Shim Pin
PDJN R/L 1616 H11							-	-
PDJN R/L 2020 K11	CD110300	BE04400	BF40009	AN01200	PA0601700	SS25	-	-
PDJN R/L 2525 M11	CD110300	BE04400	BF40009	AN01200	PA0601700	SS25	-	-
PDJN R/L 3225 P11	CD110300	BE04400	BF40009	AN01200	PA0601700	SS25	-	-
PDJN R/L 2020 K15	CD150300	BE05500	BF47509	AN14700	PA0802101	SS30	CD150500	BE05401
PDJN R/L 2525 M15	CD150300	BE05500	BF47509	AN14700	PA0802101	SS30	CD150500	BE05401
PDJN R/L 3225 P15	CD150300	BE05500	BF47509	AN14700	PA0802101	SS30	CD150500	BE05401
PDJN R/L 3232 P15	CD150300	BE05500	BF47509	AN14700	PA0802101	SS30	CD150500	BE05401
PDJN R/L 4025 R15	CD150300	BE05500	BF47509	AN14700	PA0802101	SS30	CD150500	BE05401
PDJN R/L 5032 S15	CD150300	BE05500	BF47509	AN14700	PA0802101	SS30	CD150500	BE05401

(P) LEVER LOCK TOOLHOLDERS

Roughing	Finishing	Medium to Finishing	Medium to Finishing	Medium	Medium	Medium	Medium
Flat	MF	SF	LC	MS	MR	PM	ST
							
(15)	(15)	(15)	(15)	(15)	(15)	(15)	(15)
Medium Wiper	Roughing to Medium	Roughing	Roughing	Roughing to Medium	Medium to Finishing	Medium to Finishing	
MW	SS	HR	RP	O1	O2	O3	
							
(15)	(15)	(15)	(15)	(15)	(15)	(15)	



Order Code		Reference	Dimensions (mm)					Insert	Kg	Stock	
R	L		H=h	b	L1	L2	S			R	L
212299500	212299600	PDNN R/L 2020 K15	20	20	125	34	10,0	DN.. 1506..	0,400		
212299800	212299900	PDNN R/L 2525 M15	25	25	150	34	12,5	DN.. 1506..	0,750		
212300100	212300200	PDNN R/L 3225 P15	32	25	170	34	12,5	DN.. 1506..	1,050		
212300300	212300400	PDNN R/L 3232 P15	32	32	170	34	16,0	DN.. 1506..	1,300		
212300600	212300700	PDNN R/L 4025 S15	40	25	250	34	12,5	DN.. 1506..	1,850		
212300900	212301000	PDNN R/L 5032 S15	50	32	250	34	16,0	DN.. 1506..	2,900		
212299700		PDNN N 2020 K15	20	20	125	34	10,0	DN.. 1506..	0,400		
212300000		PDNN N 2525 M15	25	25	150	34	12,5	DN.. 1506..	0,750		
212250000		PDNN N 3225 P15	32	25	170	34	12,5	DN.. 1506..	1,050		
212300500		PDNN N 3232 P15	32	32	170	34	16,0	DN.. 1506..	1,300		
212300800		PDNN N 4025 S15	40	25	250	34	12,5	DN.. 1506..	1,850		
212301100		PDNN N 5032 S15	50	32	250	34	16,0	DN.. 1506..	2,900		

 Stock Items | Itens de stock

 Available under request | Disponível sob consulta | Disponible bajo consulta

SPARE PARTS | Complementos | Repuestos

Cutter Reference	Order separately						for inserts DN.. 1504..	
	Shim	Shim Pin	Shim Pin Punch	Lever	Lever Screw	Wrench	Shim	Shim Pin
PDNN R/L/N 2020 K15								
PDNN R/L/N 2525 M15	CD150300	BE05500	BF47509	AN14700	PA0802101	SS30	CD150500	BE05401
PDNN R/L/N 3225 P15	CD150300	BE05500	BF47509	AN14700	PA0802101	SS30	CD150500	BE05401
PDNN R/L/N 3232 P15	CD150300	BE05500	BF47509	AN14700	PA0802101	SS30	CD150500	BE05401
PDNN R/L/N 4025 S15	CD150300	BE05500	BF47509	AN14700	PA0802101	SS30	CD150500	BE05401
PDNN R/L/N 5032 S15	CD150300	BE05500	BF47509	AN14700	PA0802101	SS30	CD150500	BE05401

C
TURNING
Insert selection
Overview
Negative inserts
Positive inserts
PCBN & PCD inserts
Heavy turning
External Toolholders
Internal Toolholders
Automatic Lathes
Spare Parts
Technical Data

(P) LEVER LOCK TOOLHOLDERS

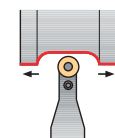

Axial: 0°
Radial: 0°

Roughing to Medium ..MT-ST (10-12-16-20)	Roughing to Medium ..MT-RF (25)	Roughing to Medium ..MT-RM (20)	Roughing to Medium ..MX-ST (10-12-16-20-25-32)
Roughing to Medium ..MX-RM (32)	Roughing to Medium ...MX-RR (25-32)	Finishing to Fine Finishing LN (10-12)	

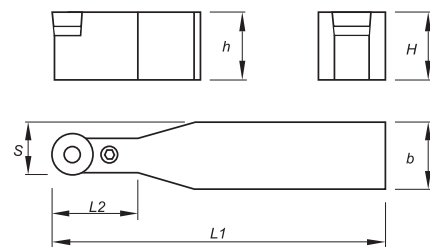

Order Code	Reference	Dimensions (mm)					Insert	Kg	Stock
		H=h	b	L1	L2	S			
212051100	PRDC N 2020 K10	20	20	125	22	15,0	RC.. 1003M0	0,400	⊗
212169000	PRDC N 2525 M10	25	25	150	22	18,5	RC.. 1003M0	0,750	⊗
212301200	PRDC N 3225 P10	32	25	170	22	18,5	RC.. 1003M0	1,050	⊗
212301300	PRDC N 2020 K12	20	20	125	28	16,0	RC.. 1204M0	0,400	⊗
212042800	PRDC N 2525 M12	25	25	150	28	18,5	RC.. 1204M0	0,750	⊗
212301400	PRDC N 3225 P12	32	25	170	28	18,5	RC.. 1204M0	1,050	⊗
212422400	PRDC N 3232 P12	32	32	180	28	22,0	RC.. 1204M0	1,300	○
212301500	PRDC N 4025 S12	40	25	250	28	18,5	RC.. 1204M0	1,850	⊗
212020600	PRDC N 3225 P16	32	25	170	34	20,5	RC.. 1606M0	1,050	⊗
212301600	PRDC N 3232 P16	32	32	170	34	24,0	RC.. 1606M0	1,300	⊗
212301700	PRDC N 3232 P20	32	32	170	42	26,0	RC.. 2006M0	1,300	⊗
212301800	PRDC N 4040 S20	40	40	250	42	30,0	RC.. 2006M0	3,050	⊗
212301900	PRDC N 4040 S25	40	40	250	45	32,5	RC.. 2507M0	3,050	⊗
212293700	PRDC N 4040 U25	40	40	350	45	32,5	RC.. 2507M0	3,050	○
212302000	PRDC N 5050 U25	50	50	350	45	37,5	RC.. 2507M0	5,850	○
212302100	PRDC N 5050 V32	50	50	400	52	41,0	RC.. 3209M0	5,850	○

⊗ Stock Items | Itens de stock

○ Available under request | Disponível sob consulta | Disponible bajo consulta

(P) LEVER LOCK TOOLHOLDERS

SPARE PARTS || Complementos | Repuestos

Cutter Reference	Order separately					
	Shim	Shim Pin	Shim Pin Punch	Lever	Lever Screw	Wrench
PRDC N 2020 K10	CR100300	BE03800	BF40009	AC11700	PA0501400	SS20
PRDC N 2525 M10	CR100300	BE03800	BF40009	AC11700	PA0501400	SS20
PRDC N 3225 P10	CR100300	BE03800	BF40009	AC11700	PA0501400	SS20
PRDC N 2020 K12	CR120300	BE03800	BF40009	AC13300	PA0601700	SS25
PRDC N 2525 M12	CR120300	BE03800	BF40009	AC13300	PA0601700	SS25
PRDC N 3225 P12	CR120300	BE03800	BF40009	AC13300	PA0601700	SS25
PRDC N 3232 P12	CR120300	BE03800	BF40009	AC13300	PA0601700	SS25
PRDC N 4025 S12	CR120300	BE03800	BF40009	AC13300	PA0601700	SS25
PRDC N 3225 P16	CR160500	BE05400	BF47509	AC18000	PA0602100	SS25
PRDC N 3232 P16	CR160500	BE05400	BF47509	AC18000	PA0602100	SS25
PRDC N 3232 P20	CR200500	BE07000	BF65012	AC18700	PA0802400	SS30
PRDC N 4040 S20	CR200500	BE07000	BF65012	AC18700	PA0802400	SS30
PRDC N 4040 S25	CR250600	BE08500	BF80012	AC23000	PA1003000	SS40
PRDC N 4040 U25	CR250600	BE08500	BF80012	AC23000	PA1003000	SS40
PRDC N 5050 U25	CR250600	BE08500	BF80012	AC23000	PA1003000	SS40
PRDC N 5050 V32	CR320600	BE10500	BF12520	AC26700	PA1203600	SS50



TURNING

Insert selection

Overview

Negative inserts

Positive inserts

PCBN & PCD inserts

Heavy turning

External Toolholders







Internal Toolholders

Automatic Lathes

Spare Parts

Technical Data





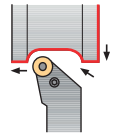



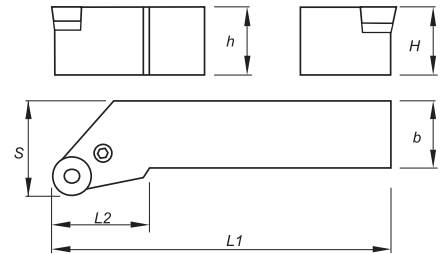















(P) LEVER LOCK TOOLHOLDERS

Roughing to Medium ..MT-ST  (10-12-16-20)	Roughing to Medium ..MT-RF  (25)	Roughing to Medium ..MT-RM  (20)	Roughing to Medium ..MX-ST  (10-12-16-20-25-32)
Roughing to Medium ..MX-RM  (32)	Roughing to Medium ..MX-RR  (25-32)	Finishing to Fine LN  (10-12)	



Axial: 0°
Radial: 0°



Order Code		Reference	Dimensions (mm)					Insert	Kg	Stock	
R	L		H=h	b	L1	L2	S			R	L
212302200	212302300	PRSC R/L 2020 K10	20	20	125	28	25	RC.. 1003M0	0,400		
212302400	212302500	PRSC R/L 2525 M10	25	25	150	28	32	RC.. 1003M0	0,750		
212302600	212302700	PRSC R/L 3225 P10	32	25	170	28	32	RC.. 1003M0	1,050		
212302800	212302900	PRSC R/L 2020 K12	20	20	125	28	25	RC.. 1204M0	0,400		
212303000	212303100	PRSC R/L 2525 M12	25	25	150	28	32	RC.. 1204M0	0,750		
212303200	212303300	PRSC R/L 3225 P12	32	25	170	28	32	RC.. 1204M0	1,050		
212303500	212303400	PRSC R/L 2525 M16	25	25	150	34	32	RC.. 1606M0	0,750		
212020800	212020700	PRSC R/L 3225 P16	32	25	170	34	32	RC.. 1606M0	1,050		
212303700	212303600	PRSC R/L 3232 P20	32	32	170	42	40	RC.. 2006M0	1,300		
212303900	212303800	PRSC R/L 4040 S20	40	40	250	42	50	RC.. 2006M0	3,050		
212304100	212304000	PRSC R/L 4040 S25	40	40	250	45	50	RC.. 2507M0	3,050		
212020900	212304200	PRSC R/L 5050 T32	50	50	300	45	63	RC.. 3209M0	5,850		

 Stock Itens | Itens de stock









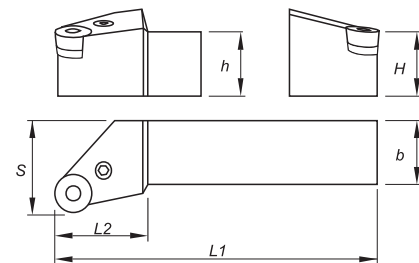
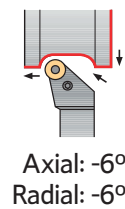
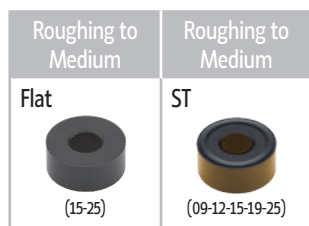

 Available under request | Disponível sob consulta | Disponible bajo consulta

SPARE PARTS | Complementos | Repuestos

Cutter Reference	Order separately					
	Shim	Shim Pin	Shim Pin Punch	Lever	Lever Screw	Wrench
PRSC R/L 2020 K10						
PRSC R/L 2525 M10	CR100300	BE03800	BF40009	AC11700	PA0501400	SS20
PRSC R/L 3225 P10	CR100300	BE03800	BF40009	AC11700	PA0501400	SS20
PRSC R/L 2020 K12	CR120300	BE03800	BF40009	AC13300	PA0601700	SS25
PRSC R/L 2525 M12	CR120300	BE03800	BF40009	AC13300	PA0601700	SS25
PRSC R/L 3225 P12	CR120300	BE03800	BF40009	AC13300	PA0601700	SS25
PRSC R/L 2525 M16	CR160500	BE05400	BF47509	AC18000	PA0602100	SS25
PRSC R/L 3225 P16	CR160500	BE05400	BF47509	AC18000	PA0602100	SS25
PRSC R/L 3232 P20	CR200500	BE07000	BF65012	AC18700	PA0802400	SS30
PRSC R/L 4040 S20	CR200500	BE07000	BF65012	AC18700	PA0802400	SS30
PRSC R/L 4040 S25	CR250600	BE08500	BF80012	AC23000	PA0802400	SS40
PRSC R/L 5050 T32	CR320600	BE10500	BF12520	AC26700	PA1203600	SS50

(P) LEVER LOCK TOOLHOLDERS









Order Code		Reference	Dimensions (mm)					Insert	Kg	Stock	
R	L		H=h	b	L1	L2	S			R	L
212046800	212304300	PRSN R/L 2020 K09	20	20	125	22	25	RNMG 090300	0,400		
212046900	212304400	PRSN R/L 2525 M12	25	25	150	28	32	RNMG 120400	0,750		
212047000	212304500	PRSN R/L 3225 P15	32	25	170	34	32	RNMG 150600	1,050		
212304600	212304700	PRSN R/L 3232 P19	32	32	170	42	40	RNMG 190600	1,300		
212304800	212304900	PRSN R/L 4040 S25	40	40	250	45	50	RNMG 250900	3,050		







 Stock Items | Itens de stock

 Available under request | Disponível sob consulta | Disponible bajo consulta









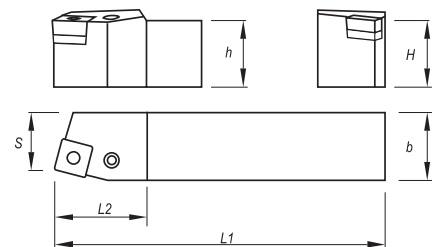
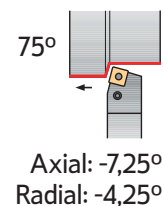

















SPARE PARTS || Complementos | Repuestos

Cutter Reference	Order separately					
	Shim	Shim Pin	Shim Pin Punch	Lever	Lever Screw	Wrench
PRSN R/L 2020 K09						
PRSN R/L 2525 M12	CR090300	BE03800	BF40009	AN01200	PA0601700	SS25
PRSN R/L 3225 P15	CR120302	BE05500	BF47509	AN13100	PA0802100	SS30
PRSN R/L 3232 P19	CR150500	BE07000	BF65012	AN17200	PA0802400	SS30
PRSN R/L 4040 S25	CR190500	BE08500	BF80012	AN20800	PA1002700	SS40
PRSN R/L 4040 S25	CR250601	BE10500	BF12520	AN25200	PA1203600	SS50

(P) LEVER LOCK TOOLHOLDERS

Roughing	Finishing	Medium	Medium	Medium	Medium
Flat  (09-12-15-19-25)	MF  (12)	SF  (12)	MR  (12-15-19)	PM  (12)	ST  (09-12-15-19)
Roughing to Medium	Roughing	Roughing	Heavy to Roughing	Heavy to Roughing	
SS  (09-12-15-19)	HR  (12-15-19-25)	RP  (15-19)	HY  (19-25)	HZ  (19-25)	



Order Code		Reference	Dimensions (mm)					Insert	Kg	Stock	
R	L		H=h	b	L1	L2	S			R	L
212305000	212305100	PSBN R/L 1212 F09	12	12	80	18	11	SN.. 0903..	0,100		
212305200	212305300	PSBN R/L 1616 H09	16	16	100	22	13	SN.. 0903..	0,250		
212305400	212305500	PSBN R/L 2020 K09	20	20	125	22	17	SN.. 0903..	0,400		
212032200	212032300	PSBN R/L 2020 K12	20	20	125	28	17	SN.. 1204..	0,400		
212014300	212032400	PSBN R/L 2525 M12	25	25	150	28	22	SN.. 1204..	0,750		
212305600	212305700	PSBN R/L 3225 P12	32	25	170	28	22	SN.. 1204..	1,050		
212014400	212305800	PSBN R/L 2525 M15	25	25	150	34	22	SN.. 1506..	0,750		
212305900	212306000	PSBN R/L 3232 P15	32	32	170	34	27	SN.. 1506..	1,300		
212306100	212306200	PSBN R/L 3232 P19	32	32	170	42	27	SN.. 1906..	1,300		
212306300	212306400	PSBN R/L 4040 S19	40	40	250	45	35	SN.. 1906..	3,050		
212422500	212422600	PSBN R/L 5050 T19	50	50	300	50	43	SN.. 1906..	3,050		
212306500	212014100	PSBN R/L 4040 S25	40	40	250	45	35	SN.. 2507..	3,050		
212306600	212306700	PSBN R/L 5050 T25	50	50	300	45	43	SN.. 2507..	5,850		











 Stock Items | Itens de stock

Available under request | Disponível sob consulta | Disponible bajo consulta

SPARE PARTS | Complementos | Repuestos

Cutter Reference	Order separately					
	Shim	Shim Pin	Shim Pin Punch	Lever	Lever Screw	Wrench
PSBN R/L 1212 F09	-	-	-	AN07800	PA0501000	SS20
PSBN R/L 1616 H09	CS090301	BE03800	-	AN01200	PA0601700	SS25
PSBN R/L 2020 K09	CS090301	BE03800	-	AN01200	PA0601700	SS25
PSBN R/L 2020 K12	CS120302	BE05500	BF47509	AN13100	PA0802100	SS30
PSBN R/L 2525 M12	CS120302	BE05500	BF47509	AN13100	PA0802100	SS30
PSBN R/L 3225 P12	CS120302	BE05500	BF47509	AN13100	PA0802100	SS30
PSBN R/L 2525 M15	CS150400	BE07000	BF65012	AN17100	PA0802300	SS30
PSBN R/L 3232 P15	CS150400	BE07000	BF65012	AN17100	PA0802300	SS30
PSBN R/L 3232 P19	CS190400	BE08500	BF80012	AN20800	PA1002700	SS40
PSBN R/L 4040 S19	CS190400	BE08500	BF80012	AN20800	PA1002700	SS40
PSBN R/L 5050 T19	CS190400	BE08500	BF80012	AN20800	PA1002700	SS40
PSBN R/L 4040 S25	CS250600	BE10500	BF12520	AN25200	PA1203600	SS50
PSBN R/L 5050 T25	CS250600	BE10500	BF12520	AN25200	PA1203600	SS50

(P) LEVER LOCK TOOLHOLDERS

Roughing	Finishing	Medium	Medium	Medium	Medium
Flat  (09-12-19-25)	MF  (12)	SF  (12)	MR  (12-19)	PM  (12)	ST  (09-12-19)
Roughing to Medium	Roughing	Roughing	Heavy to Roughing	Heavy to Roughing	
SS  (09-12-19)	HR  (12-19-25)	RP  (19)	HY  (19-25)	HZ  (19-25)	

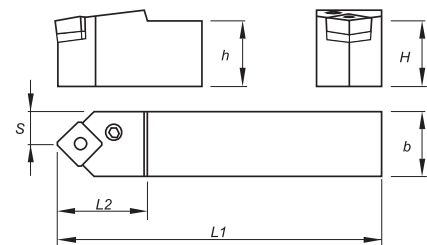
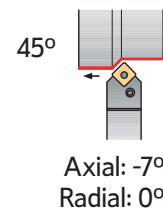

Order Code	Reference	Dimensions (mm)					Insert	Kg	Stock	
		H=h	b	L1	L2	S			R	L
212306800	PSDN N 1010 E09	10	10	70	16	5,0	SN.. 0903..	0,070	⊗	
212306900	PSDN N 1212 F09	12	12	80	18	6,0	SN.. 0903..	0,100	⊗	
212307000	PSDN N 1616 H09	16	16	100	22	8,0	SN.. 0903..	0,250	⊗	
212056700	PSDN N 2020 K12	20	20	125	28	10,0	SN.. 1204..	0,400	⊗	
212307100	PSDN N 2525 M12	25	25	150	28	12,5	SN.. 1204..	0,750	⊗	
212307200	PSDN N 3225 P12	32	25	170	28	12,5	SN.. 1204..	1,050	⊗	
212307300	PSDN N 3232 P12	32	32	170	28	16,0	SN.. 1204..	1,300	⊗	
212307400	PSDN N 3225 P19	32	25	170	42	12,5	SN.. 1906..	1,050	⊗	
212249100	PSDN N 3232 P19	32	32	170	42	16,0	SN.. 1906..	1,300	⊗	
212307500	PSDN N 4040 S25	40	40	250	45	20,0	SN.. 2507..	3,050	⊗	
212307600	PSDN N 5050 T25	50	50	300	45	25,0	SN.. 2507..	5,850	⊗	

⊗ Stock Items | Itens de stock

○ Available under request | Disponível sob consulta | Disponible bajo consulta

SPARE PARTS | Complementos | Repuestos

Cutter Reference	Order separately					
	Shim	Shim Pin	Shim Pin Punch	Lever	Lever Screw	Wrench
PSDN N 1010 E09	-	-	-	AN07800	PA0501000	SS20
PSDN N 1212 F09	-	-	-	AN07800	PA0501000	SS20
PSDN N 1616 H09	CS090301	BE03800	BF40009	AN01200	PA0601700	SS25
PSDN N 2020 K12	CS120302	BE05500	BF47509	AN13100	PA0802100	SS30
PSDN N 2525 M12	CS120302	BE05500	BF47509	AN13100	PA0802100	SS30
PSDN N 3225 P12	CS120302	BE05500	BF47509	AN13100	PA0802100	SS30
PSDN N 3232 P12	CS120302	BE05500	BF47509	AN13100	PA0802100	SS30
PSDN N 3225 P19	CS190400	BE08500	BF80012	AN20800	PA1002700	SS40
PSDN N 3232 P19	CS190400	BE08500	BF80012	AN20800	PA1002700	SS40
PSDN N 4040 S25	CS250600	BE10500	BF12520	AN25200	PA1203600	SS50
PSDN N 5050 T25	CS250600	BE10500	BF12520	AN25200	PA1203600	SS50

TURNING
Insert selection
Overview
Negative inserts
Positive inserts
PCBN & PCD inserts
Heavy turning
External Toolholders
Internal Toolholders
Automatic Lathes
Spare Parts
Technical Data

(P) LEVER LOCK TOOLHOLDERS

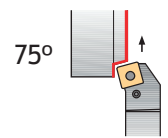

75°
Axial: -4,25°
Radial: -7,25°

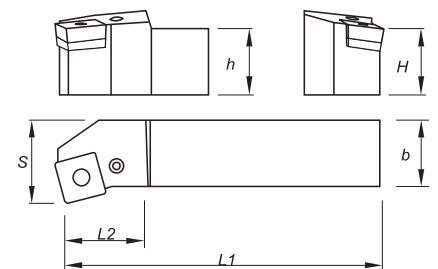

Roughing	Finishing	Medium	Medium	Medium	Medium
Flat (09-12-15-19-25)	MF (12)	SF (12)	MR (12-15-19)	PM (12)	ST (09-12-15-19)
Roughing to Medium	Roughing	Roughing	Heavy to Roughing	Heavy to Roughing	
SS (09-12-15-19)	HR (12-15-19-25)	RP (15-19)	HY (19-25)	HZ (19-25)	

Order Code		Reference	Dimensions (mm)					Insert	Kg	Stock	
R	L		H=h	b	L1	L2	S			R	L
212307700	212307800	PSKN R/L 1616 H09	16	16	100	22	20	SN.. 0903..	0,250		
212307900	212308000	PSKN R/L 2020 K09	20	20	125	22	25	SN.. 0903..	0,400		
212032500	212032600	PSKN R/L 2020 K12	20	20	125	28	25	SN.. 1204..	0,400		
212032700	212032800	PSKN R/L 2525 M12	25	25	150	28	32	SN.. 1204..	0,750		
212308100	212308200	PSKN R/L 3225 P12	32	25	170	28	32	SN.. 1204..	1,050		
212308300	212308400	PSKN R/L 2525 M15	25	25	150	34	32	SN.. 1506..	0,750		
212308500	212308600	PSKN R/L 3232 P15	32	32	170	34	40	SN.. 1506..	1,300		
212308700	212308800	PSKN R/L 3232 P19	32	32	170	42	40	SN.. 1906..	1,300		
212308900	212309000	PSKN R/L 4040 S19	40	40	250	45	50	SN.. 1906..	3,050		
212309100	212309200	PSKN R/L 4040 S25	40	40	250	45	50	SN.. 2507..	3,050		
212309300	212309400	PSKN R/L 5050 T25	50	50	300	45	60	SN.. 2507..	5,850		

Stock Items | Itens de stock

Available under request | Disponível sob consulta | Disponible bajo consulta

SPARE PARTS | Complementos | Repuestos

Cutter Reference	Order separately					
	Shim	Shim Pin	Shim Pin Punch	Lever	Lever Screw	Wrench
PSKN R/L 1616 H09	CS090301	BE03800	BF40009	AN01200	PA0601700	SS25
PSKN R/L 2020 K09	CS090301	BE03800	BF40009	AN01200	PA0601700	SS25
PSKN R/L 2020 K12	CS120302	BE05500	BF47509	AN13100	PA0802100	SS30
PSKN R/L 2525 M12	CS120302	BE05500	BF47509	AN13100	PA0802100	SS30
PSKN R/L 3225 P12	CS120302	BE05500	BF47509	AN13100	PA0802100	SS30
PSKN R/L 2525 M15	CS150400	BE07000	BF65012	AN17100	PA0802300	SS30
PSKN R/L 3232 P15	CS150400	BE07000	BF65012	AN17100	PA0802300	SS30
PSKN R/L 3232 P19	CS190400	BE08500	BF80012	AN20800	PA1002700	SS40
PSKN R/L 4040 S19	CS190400	BE08500	BF80012	AN20800	PA1002700	SS40
PSKN R/L 4040 S25	CS250600	BE10500	BF12520	AN25200	PA1203600	SS50
PSKN R/L 5050 T25	CS250600	BE10500	BF12520	AN25200	PA1203600	SS50

(P) LEVER LOCK TOOLHOLDERS

Roughing	Finishing	Medium	Medium	Medium	Medium
Flat	MF	SF	MR	PM	ST
(09-12-15-19-25)	(12)	(12)	(12-15-19)	(12)	(09-12-15-19)
Roughing to Medium	Roughing	Roughing	Heavy to Roughing	Heavy to Roughing	
SS	HR	RP	HY	HZ	
(09-12-15-19)	(12-15-19-25)	(15-19)	(19-25)	(19-25)	

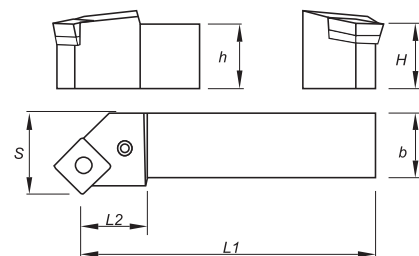
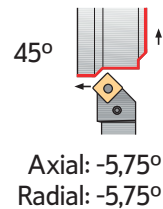

Order Code		Reference	Dimensions (mm)					Insert	Kg	Stock	
R	L		H=h	b	L1	L2	S			R	L
212066500	212309500	PSSN R/L 1616 H09	16	16	100	22	20	SN.. 0903..	0,250		
212066600	212309600	PSSN R/L 2020 K09	20	20	125	22	25	SN.. 0903..	0,400		
212032900	212033000	PSSN R/L 2020 K12	20	20	125	28	25	SN.. 1204..	0,400		
212026600	212026700	PSSN R/L 2525 M12	25	25	150	28	32	SN.. 1204..	0,750		
212309700	212309800	PSSN R/L 3225 P12	32	25	170	28	32	SN.. 1204..	1,050		
212066700	212309900	PSSN R/L 2525 M15	25	25	150	34	32	SN.. 1506..	0,750		
212420500	212420600	PSSN R/L 3225 P15	32	25	170	42	32	SN.. 1506..	1,050		
212066800	212015400	PSSN R/L 3232 P15	32	32	170	34	40	SN.. 1506..	1,300		
212066900	212310000	PSSN R/L 3232 P19	32	32	170	42	40	SN.. 1906..	1,300		
212067000	212310100	PSSN R/L 4040 S19	40	40	250	45	50	SN.. 1906..	3,050		
212310200	212310300	PSSN R/L 5050 T19	50	50	300	45	60	SN.. 1906..	5,850		
212310400	212310500	PSSN R/L 4040 S25	40	40	250	45	50	SN.. 2507..	3,050		
212310600	212310700	PSSN R/L 5050 T25	50	50	300	45	60	SN.. 2507..	5,850		

Stock Items | Itens de stock

Available under request | Disponível sob consulta | Disponible bajo consulta







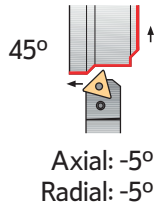

SPARE PARTS | Complementos | Repuestos

Cutter Reference	Order separately					
	Shim	Shim Pin	Shim Pin Punch	Lever	Lever Screw	Wrench
PSSN R/L 1616 H09	CS090301	BE03800	BF40009	AN01200	PA0601700	SS25
PSSN R/L 2020 K09	CS090301	BE03800	BF40009	AN01200	PA0601700	SS25
PSSN R/L 2020 K12	CS120302	BE05500	BF47509	AN13100	PA0802100	SS30
PSSN R/L 2525 M12	CS120302	BE05500	BF47509	AN13100	PA0802100	SS30
PSSN R/L 3225 P12	CS120302	BE05500	BF47509	AN13100	PA0802100	SS30
PSSN R/L 2525 M15	CS150400	BE07000	BF65012	AN17100	PA0802300	SS30
PSSN R/L 3225 P15	CS150400	BE07000	BF65012	AN17100	PA0802300	SS30
PSSN R/L 3232 P15	CS150400	BE07000	BF65012	AN17100	PA0802300	SS30
PSSN R/L 3232 P19	CS190400	BE08500	BF80012	AN20800	PA1002700	SS40
PSSN R/L 4040 S19	CS190400	BE08500	BF80012	AN20800	PA1002700	SS40
PSSN R/L 5050 T19	CS190400	BE08500	BF80012	AN20800	PA1002700	SS40
PSSN R/L 4040 S25	CS250600	BE10500	BF12520	AN25200	PA1203600	SS50
PSSN R/L 5050 T25	CS250600	BE10500	BF12520	AN25200	PA1203600	SS50





TURNING
Insert selection
Overview
Negative inserts
Positive inserts
PCBN & PCD inserts
Heavy turning
External Toolholders
Internal Toolholders
Automatic Lathes
Spare Parts
Technical Data

(P) LEVER LOCK TOOLHOLDERS

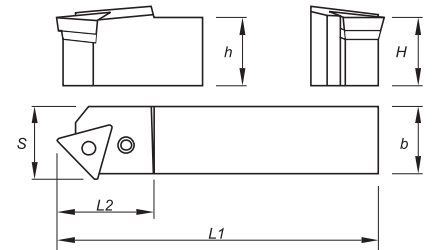

Roughing	Finishing	Medium to Finishing	Medium to Finishing	Medium
Flat	MF	SF	LC	MR
 (22)	 (22)	 (22)	 (22)	 (22)
Medium	Medium	Roughing to Medium	Roughing	
PM	ST	SS	HR	
 (22)	 (22)	 (22)	 (22)	









Order Code		Reference	Dimensions (mm)					Insert	Kg	Stock	
R	L		H=h	b	L1	L2	S			R	L
212310800	212310900	PTDN R/L 2525 M22	25	25	150	34	27	TN.. 2204..	0,750		
212311000	212311100	PTDN R/L 3225 P22	32	25	170	34	27	TN.. 2204..	1,050		











 Stock Items | Itens de stock

 Available under request | Disponível sob consulta | Disponible bajo consulta









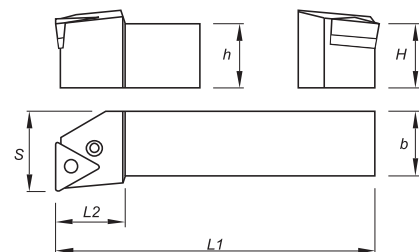
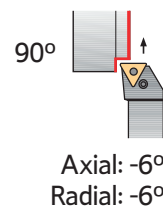









SPARE PARTS | Complementos | Repuestos

Cutter Reference	Order separately					
	Shim	Shim Pin	Shim Pin Punch	Lever	Lever Screw	Wrench
PTDN R/L 2525 M22						
PTDN R/L 2525 M22	CT220302	BE05500	BF47509	AN13100	PA0802100	SS30
PTDN R/L 3225 P22	CT220302	BE05500	BF47509	AN13100	PA0802100	SS30

(P) LEVER LOCK TOOLHOLDERS

Roughing	Finishing	Medium to Finishing	Medium to Finishing	Medium	Medium
Flat	MF	SF	LC	MS	MR
 (16-22-27)	 (16-22)	 (16-22)	 (16-22)	 (16)	 (16-22)
Medium	Medium	Roughing to Medium	Roughing	Medium to Finishing	
PM	ST	SS	HR	O1	
 (16-22)	 (16-22-27)	 (16-22)	 (16-22-27)	 (16)	









Order Code		Reference	Dimensions (mm)					Insert	Kg	Stock	
R	L		H=h	b	L1	L2	S			R	L
212056500	212311200	PTFN R/L 1616 H16	16	16	100	22	20	TN.. 1604..	0,250		
212031700	212015800	PTFN R/L 2020 K16	20	20	125	22	25	TN.. 1604..	0,400		
212036500	212015900	PTFN R/L 2525 M16	25	25	150	22	32	TN.. 1604..	0,750		
212311300	212311400	PTFN R/L 3225 P16	32	25	170	22	32	TN.. 1604..	1,050		
212031800	212311500	PTFN R/L 2525 M22	25	25	150	28	32	TN.. 2204..	0,750		
212016300	212311600	PTFN R/L 3225 P22	32	25	170	28	32	TN.. 2204..	1,050		
212311700	212311800	PTFN R/L 3232 P22	32	32	170	28	40	TN.. 2204..	1,300		
212311900	212312000	PTFN R/L 3232 P27	32	32	170	42	40	TN.. 2706..	1,300		
212312100	212312200	PTFN R/L 4040 S27	40	40	250	45	50	TN.. 2706..	3,050		

 Stock Items | Itens de stock











 Available under request | Disponível sob consulta | Disponible bajo consulta

SPARE PARTS | Complementos | Repuestos









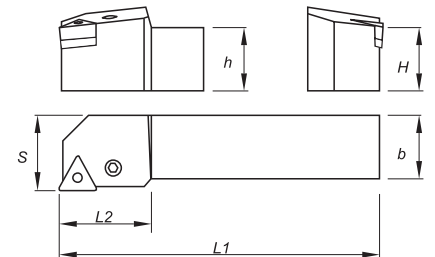
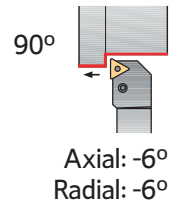













Cutter Reference	Order separately					
	Shim	Shim Pin	Shim Pin Punch	Lever	Lever Screw	Wrench
PTFN R/L 1616 H16						
PTFN R/L 2020 K16	CT160303	BE04400	BF40009	AN01200	PA0601700	SS25
PTFN R/L 2525 M16	CT160303	BE04400	BF40009	AN01200	PA0601700	SS25
PTFN R/L 3225 P16	CT160303	BE04400	BF40009	AN01200	PA0601700	SS25
PTFN R/L 2525 M22	CT220302	BE05500	BF47509	AN13100	PA0802100	SS30
PTFN R/L 3225 P22	CT220302	BE05500	BF47509	AN13100	PA0802100	SS30
PTFN R/L 3232 P22	CT220302	BE05500	BF47509	AN13100	PA0802100	SS30
PTFN R/L 3232 P27	CT270500	BE05500	BF65012	AN17200	PA0802400	SS30
PTFN R/L 4040 S27	CT270500	BE05500	BF65012	AN17200	PA0802400	SS30

C
TURNING
Insert selection
Overview
Negative inserts
Positive inserts
PCBN & PCD inserts
Heavy turning
External Toolholders
Internal Toolholders
Automatic Lathes
Spare Parts
Technical Data

(P) LEVER LOCK TOOLHOLDERS

Roughing	Finishing	Medium to Finishing	Medium to Finishing	Medium	Medium
Flat  (16-22-27-33)	MF  (16-22)	SF  (16-22)	LC  (16-22)	MS  (16)	MR  (16-22)
Medium	Medium	Roughing to Medium	Roughing	Medium to Finishing	
PM  (16-22)	ST  (16-22-27-33)	SS  (16-22)	HR  (16-22-27-33)	O1  (16)	









Order Code		Reference	Dimensions (mm)					Insert	Kg	Stock	
R	L		H=h	b	L1	L2	S			R	L
212052700	212312300	PTGN R/L 1616 H16	16	16	100	22	20	TN.. 1604..	0,250		
212031900	212016500	PTGN R/L 2020 K16	20	20	125	22	25	TN.. 1604..	0,400		
212026500	212037400	PTGN R/L 2525 M16	25	25	150	22	32	TN.. 1604..	0,750		
212312400	212312500	PTGN R/L 3225 P16	32	25	170	22	32	TN.. 1604..	1,050		
212032000	212032100	PTGN R/L 2525 M22	25	25	150	28	32	TN.. 2204..	0,750		
212312600	212312700	PTGN R/L 3225 P22	32	25	170	28	32	TN.. 2204..	1,050		
212058500	212312800	PTGN R/L 3232 P22	32	32	170	28	40	TN.. 2204..	1,300		
212058600	212312900	PTGN R/L 4040 S22	40	40	250	34	50	TN.. 2204..	3,050		
212066100	212313000	PTGN R/L 3232 P27	32	32	170	42	40	TN.. 2706..	1,300		
212313100	212313200	PTGN R/L 4040 S27	40	40	250	45	50	TN.. 2706..	3,050		
212250300	212313300	PTGN R/L 5050 T33	50	50	300	45	60	TN.. 3307..	5,850		











 Stock Items | Itens de stock

 Available under request | Disponível sob consulta | Disponible bajo consulta









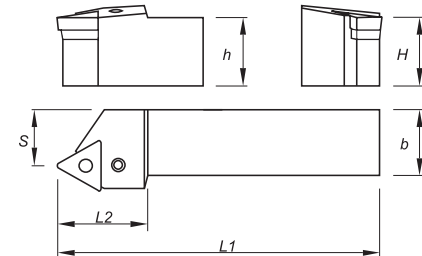
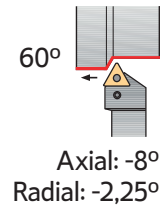

SPARE PARTS | Complementos | Repuestos

Cutter Reference	Order separately					
	Shim	Shim Pin	Shim Pin Punch	Lever	Lever Screw	Wrench
PTGN R/L 1616 H16						
PTGN R/L 2020 K16	CT160303	BE04400	BF40009	AN01200	PA0601700	SS25
PTGN R/L 2525 M16	CT160303	BE04400	BF40009	AN01200	PA0601700	SS25
PTGN R/L 3225 P16	CT160303	BE04400	BF40009	AN01200	PA0601700	SS25
PTGN R/L 2525 M22	CT220302	BE05500	BF47509	AN13100	PA0802100	SS30
PTGN R/L 3225 P22	CT220302	BE05500	BF47509	AN13100	PA0802100	SS30
PTGN R/L 3232 P22	CT220302	BE05500	BF47509	AN13100	PA0802100	SS30
PTGN R/L 4040 S22	CT220302	BE05500	BF47509	AN13100	PA0802100	SS30
PTGN R/L 3232 P27	CT270500	BE07000	BF65012	AN17200	PA0802400	SS30
PTGN R/L 4040 S27	CT270500	BE07000	BF65012	AN17200	PA0802400	SS30
PTGN R/L 5050 T33	CT330500	BE08301	BF80012	AN20800	PA1002700	SS40

(P) LEVER LOCK TOOLHOLDERS

Roughing	Finishing	Medium to Finishing	Medium to Finishing	Medium	Medium
Flat	MF	SF	LC	MS	MR
 (16-22)	 (16-22)	 (16-22)	 (16-22)	 (16)	 (16-22)
Medium	Medium	Roughing to Medium	Roughing	Medium to Finishing	
PM	ST	SS	HR	O1	
 (16-22)	 (16-22)	 (16-22)	 (16-22)	 (16)	









Order Code		Reference	Dimensions (mm)					Insert	Kg	Stock	
R	L		H=h	b	L1	L2	S			R	L
212313400	212313500	PTTN R/L 1616 H16	16	16	100	25	13	TN.. 1604..	0,250		
212313600	212313700	PTTN R/L 2020 K16	20	20	125	28	17	TN.. 1604..	0,400		
212313800	212313900	PTTN R/L 2525 M16	25	25	150	28	22	TN.. 1604..	0,750		
212314000	212314100	PTTN R/L 2525 M22	25	25	150	34	22	TN.. 2204..	0,750		
212314200	212314300	PTTN R/L 3225 P22	32	25	170	34	22	TN.. 2204..	1,050		











 Stock Items | Itens de stock

 Available under request | Disponível sob consulta | Disponible bajo consulta









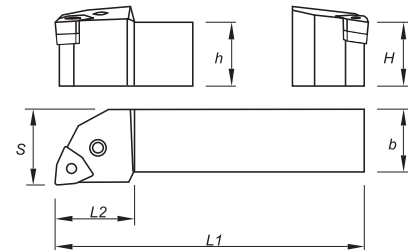
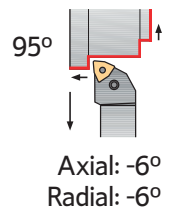





SPARE PARTS | Complementos | Repuestos

Cutter Reference	Order separately					
	Shim	Shim Pin	Shim Pin Punch	Lever	Lever Screw	Wrench
PTTN R/L 1616 H16						
PTTN R/L 2020 K16	CT160303	BE04400	BF40009	AN01200	PA0601700	SS25
PTTN R/L 2525 M16	CT160303	BE04400	BF40009	AN01200	PA0601700	SS25
PTTN R/L 2525 M22	CT220302	BE05500	BF47509	AN13100	PA0802100	SS30
PTTN R/L 3225 P22	CT220302	BE05500	BF47509	AN13100	PA0802100	SS30

(P) LEVER LOCK TOOLHOLDERS

Roughing	Finishing	Medium to Finishing	Medium to Finishing	Medium	Medium
Flat  (08)	MF  (06-08)	SF  (06-08)	LC  (08)	MS  (06-08)	PM  (08)
Medium	Medium	Medium Wiper	Roughing to Medium	Roughing	
MR  (06-08)	ST  (08)	MW  (06-08)	SS  (06-08)	HR  (08)	









Order Code		Reference	Dimensions (mm)					Insert	Kg	Stock	
R	L		H=h	b	L1	L2	S			R	L
212314400	212314500	PWLN R/L 1616 H06	16	16	100	15	20	WN.. 0604..	0,250		
212314600	212046500	PWLN R/L 2020 K06	20	20	125	25	25	WN.. 0604..	0,400		
212314700	212314800	PWLN R/L 2525 M06	25	25	150	25	32	WN.. 0604..	0,750		
212049300	212314900	PWLN R/L 2020 K08	20	20	125	34	25	WN.. 0804..	0,400		
212052800	212079100	PWLN R/L 2525 M08	25	25	150	34	32	WN.. 0804..	0,750		
212046600	212315000	PWLN R/L 3225 P08	32	25	170	34	32	WN.. 0804..	1,050		
212058000	212315100	PWLN R/L 3232 P08	32	32	170	34	40	WN.. 0804..	1,300		

 Stock Items | Itens de stock

 Available under request | Disponível sob consulta | Disponible bajo consulta

SPARE PARTS || Complementos | Repuestos

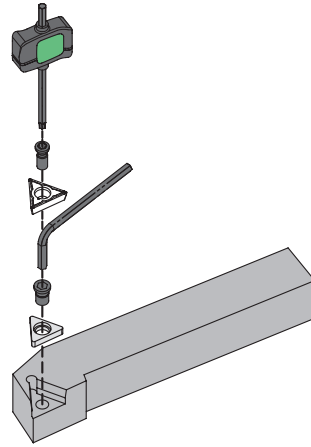

Cutter Reference	Order separately					
	Shim	Shim Pin	Shim Pin Punch	Lever	Lever Screw	Wrench
PWLN R/L 1616 H06						
PWLN R/L 2020 K06	CW060301	BE04400	BF40009	AN01200	PA0601700	SS25
PWLN R/L 2525 M06	CW060301	BE04400	BF40009	AN01200	PA0601700	SS25
PWLN R/L 2020 K08	CW080300	BE05500	BF47509	AN13100	PA0802100	SS30
PWLN R/L 2525 M08	CW080300	BE05500	BF47509	AN13100	PA0802100	SS30
PWLN R/L 3225 P08	CW080300	BE05500	BF47509	AN13100	PA0802100	SS30
PWLN R/L 3232 P08	CW080300	BE05500	BF47509	AN13100	PA0802100	SS30

(S) CENTER SCREW SYSTEM

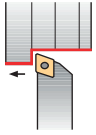
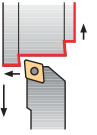
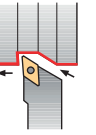
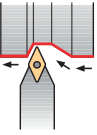
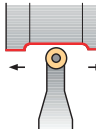
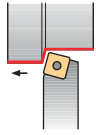
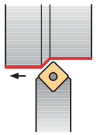
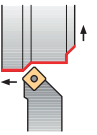
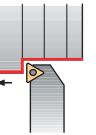
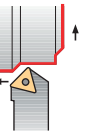
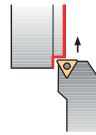
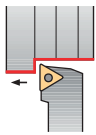
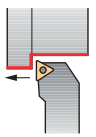
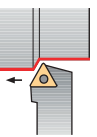
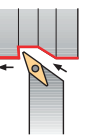
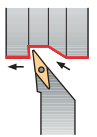
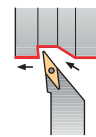
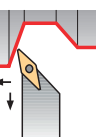
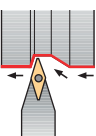
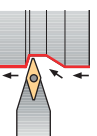
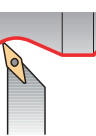
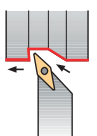







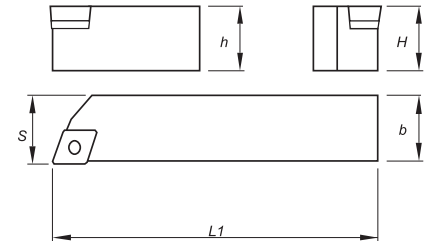
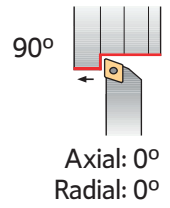





<p>SCAC 90°</p>  <p>PAGE C - 586 CC.. 0602.. CC.. 09T3.. CC.. 1204..</p>	<p>SCLC 95°</p>  <p>PAGE C - 587 CC.. 0602.. CC.. 09T3.. CC.. 1204..</p>	<p>SDJC 93°</p>  <p>PAGE C - 588 DC.. 0702.. DC.. 11T3..</p>	<p>SDNC 62°30'</p>  <p>PAGE C - 589 DC.. 0702.. DC.. 11T3..</p>	<p>SRDC</p>  <p>PAGE C - 590 RC.. 0602M0.. ... RC.. 1204M0..</p>	<p>SSBC 75°</p>  <p>PAGE C - 591 SC.. 09T3.. SC.. 1204..</p>
<p>SSDC 45°</p>  <p>PAGE C - 592 SC.. 09T3.. SC.. 1204..</p>	<p>SSSC 45°</p>  <p>PAGE C - 593 SC.. 09T3.. SC.. 1204..</p>	<p>STAC 90°</p>  <p>PAGE C - 594 TC.. 0902.. TC.. 1102.. TC.. 16T3..</p>	<p>STDC 45°</p>  <p>PAGE C - 595 TC.. 0902.. TC.. 1102.. TC.. 16T3..</p>	<p>STFC 90°</p>  <p>PAGE C - 596 TC.. 0902.. TC.. 1102.. TC.. 16T3..</p>	<p>STGC 90°</p>  <p>PAGE C - 597 TC.. 0902.. TC.. 1102.. TC.. 16T3..</p>
<p>STJC 93°</p>  <p>PAGE C - 598 TC.. 0902.. TC.. 1102.. TC.. 16T3..</p>	<p>STTC 60°</p>  <p>PAGE C - 599 TC.. 0902.. TC.. 1102.. TC.. 16T3..</p>	<p>SVHC 107°30'</p>  <p>PAGE C - 600 VC.. 1604..</p>	<p>SVJB 93°</p>  <p>PAGE C - 601 VB.. 1604..</p>	<p>SVJC 93°</p>  <p>PAGE C - 602 VC.. 1103.. VC.. 1604..</p>	<p>SVLC 95°</p>  <p>PAGE C - 603 VC.. 1303..</p>
<p>SVVB 72°30'</p>  <p>PAGE C - 604 VB.. 1604..</p>	<p>SVVC 72°30'</p>  <p>PAGE C - 605 VC.. 1103.. VC.. 1604..</p>	<p>SVXC 113°</p>  <p>PAGE C - 606 VC.. 1803..</p>	<p>SVZC 100°</p>  <p>PAGE C - 607 VC.. 1604..</p>		

(S) CENTER SCREW TOOLHOLDERS

Finishing	Finishing	Finishing	Finishing	Finishing	Finishing wiper	Medium to Finishing
Flat  (06-09-12)	FP  (06-09-12)	BO  (06-09-12)	FM  (06-09-12)	FK  (06-09-12)	FW  (06-09)	LM  (06-09-12)
Medium	Medium	Medium	Medium to Finishing wiper	Finishing to Fine finishing	Medium to Finishing	
MP  (06-09-12)	MM  (06-09-12)	MK  (06-09-12)	MW  (06-09-12)	FS  (06-09)	LN  (06-09-12)	







Order Code		Reference	Dimensions (mm)				Insert	Kg	Stock	
R	L		H=h	b	L1	S			R	L
212139500	212139400	SCAC R/L 0808 D06	8	8	60	8,5	CC.. 0602..	0,050		
212139700	212139600	SCAC R/L 1010 E06	10	10	70	10,5	CC.. 0602..	0,070		
212139900	212139800	SCAC R/L 1212 F09	12	12	80	12,5	CC.. 09T3..	0,100		
212140100	212140000	SCAC R/L 1616 H09	16	16	100	16,5	CC.. 09T3..	0,200		
212140300	212140200	SCAC R/L 2020 K12	20	20	125	20,5	CC.. 1204..	0,400		
212140500	212140400	SCAC R/L 2525 M12	25	25	150	25,5	CC.. 1204..	0,700		













 Stock Items | Itens de stock

Available under request | Disponível sob consulta | Disponible bajo consulta









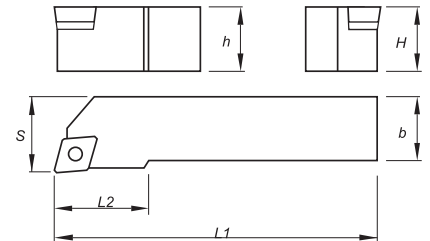
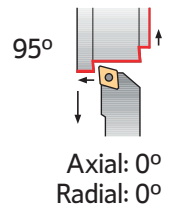





SPARE PARTS || Complementos | Repuestos

Cutter Reference	Shim 	Shim Screw 	Screw 	Wrench 
SCAC R/L 0808 D06	-	-	P0250700	XT07
SCAC R/L 1010 E06	-	-	P0250700	XT07
SCAC R/L 1212 F09	-	-	P0401100	XT15-S35
SCAC R/L 1616 H09	-	-	P0401100	XT15-S35
SCAC R/L 2020 K12	CC120401	T06004000	P0401400	XT15-S40
SCAC R/L 2525 M12	CC120401	T06004000	P0401400	XT15-S40

(S) CENTER SCREW TOOLHOLDERS

Finishing	Finishing	Finishing	Finishing	Finishing	Finishing wiper	Medium to Finishing
Flat  (06-09-12)	FP  (06-09-12)	BO  (06-09-12)	FM  (06-09-12)	FK  (06-09-12)	FW  (06-09)	LM  (06-09-12)
Medium	Medium	Medium	Medium to Finishing wiper	Finishing to Fine finishing	Medium to Finishing	
MP  (06-09-12)	MM  (06-09-12)	MK  (06-09-12)	MW  (06-09-12)	FS  (06-09)	LN  (06-09-12)	







Order Code		Reference	Dimensions (mm)					Insert	Kg	Stock	
R	L		H=h	b	L1	L2	S			R	L
212140700	212140600	SCLC R/L 0808 D06	8	8	60	10	10	CC.. 0602..	0,050		
212045400	212140800	SCLC R/L 1010 E06	10	10	70	10	12	CC.. 0602..	0,070		
212037100	212140900	SCLC R/L 1212 F09	12	12	80	16	16	CC.. 09T3..	0,100		
212047600	212141000	SCLC R/L 1616 H09	16	16	100	16	20	CC.. 09T3..	0,200		
212037500	212141100	SCLC R/L 2020 K09	20	20	125	16	25	CC.. 09T3..	0,400		
212037700	212141200	SCLC R/L 2020 K12	20	20	125	25	25	CC.. 1204..	0,400		
212037900	212141300	SCLC R/L 2525 M12	25	25	150	25	32	CC.. 1204..	0,700		

 Stock Items | Itens de stock

 Available under request | Disponível sob consulta | Disponible bajo consulta









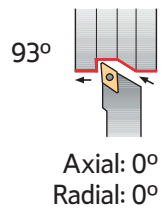

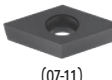
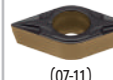
SPARE PARTS | Complementos | Repuestos

Cutter Reference	Shim 	Shim Screw 	Screw 	Wrench 
SCLC R/L 0808 D06	-	-	P0250700	XT07
SCLC R/L 1010 E06	-	-	P025070	XT07
SCLC R/L 1212 F09	-	-	P0401100	XT15-S35
SCLC R/L 1616 H09	-	-	P0401100	XT15-S35
SCLC R/L 2020 K09	-	-	P0401100	XT15-S35
SCLC R/L 2020 K12	CC120401	T06004000	P0401400	XT15-S40
SCLC R/L 2525 M12	CC120401	T06004000	P0401400	XT15-S40

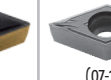





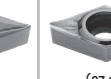

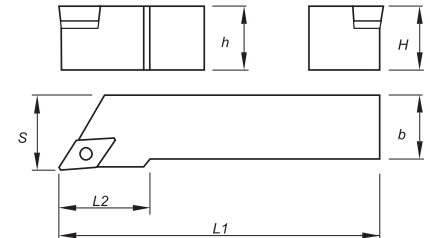





C
TURNING
Insert selection
Overview
Negative inserts
Positive inserts
PCBN & PCD inserts
Heavy turning
External Toolholders
Internal Toolholders
Automatic Lathes
Spare Parts
Technical Data

(S) CENTER SCREW TOOLHOLDERS



Finishing	Finishing	Finishing	Finishing	Finishing wiper	Medium to Finishing
Flat	FP	FM	FK	FW	LM
 (07-11)	 (07-11)	 (07-11)	 (07-11)	 (07-11)	 (07-11)
Medium	Medium	Medium	Medium to Finishing wiper	Finishing to Fine Finishing	Finishing to Fine Finishing
MP	MM	MK	MW	FS	LN
 (07-11)	 (07-11)	 (07-11)	 (11)	 (07-11)	 (07-11)







Order Code		Reference	Dimensions (mm)					Insert	Kg	Stock	
R	L		H=h	b	L1	L2	S			R	L
212143800	212143700	SDJC R/L 1010 E07	10	10	70	16	12	DC.. 0702..	0,070		
212021500	212143900	SDJC R/L 1212 F07	12	12	80	18	16	DC.. 0702..	0,100		
212420700	212420800	SDJC R/L 1616 H07	16	16	100	16	20	DC.. 0702..	0,150		
212021600	212144000	SDJC R/L 1212 F11	12	12	80	18	16	DC.. 11T3..	0,100		
212035100	212035200	SDJC R/L 1616 H11	16	16	100	22	20	DC.. 11T3..	0,200		
212036200	212035300	SDJC R/L 2020 K11	20	20	125	22	25	DC.. 11T3..	0,400		
212042600	212144100	SDJC R/L 2525 M11	25	25	150	22	32	DC.. 11T3..	0,700		









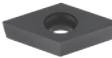

 Stock Items | Itens de stock

 Available under request | Disponível sob consulta | Disponible bajo consulta

SPARE PARTS || Complementos | Repuestos

Cutter Reference	Shim	Shim Screw	Screw	Wrench
SDJC R/L 1010 E07				
SDJC R/L 1212 F07	-	-	P0250700	XT07
SDJC R/L 1616 H07	-	-	P0250700	XT07
SDJC R/L 1212 F11	-	-	P0401100	XT15-S35
SDJC R/L 1616 H11	CD110301	T05003500	P0351500	XT15-S35
SDJC R/L 2020 K11	CD110301	T05003500	P0351500	XT15-S35
SDJC R/L 2525 M11	CD110301	T05003500	P0351500	XT15-S35

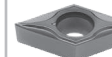
(S) CENTER SCREW TOOLHOLDERS

Finishing	Finishing	Finishing	Finishing	Medium to Finishing
Flat	FP	FM	FK	LM
 (07-11)	 (07-11)	 (07-11)	 (07-11)	 (07-11)
Medium	Medium	Medium	Finishing to Fine Finishing	Finishing to Fine Finishing
MP	MM	MK	FS	LN
 (07-11)	 (07-11)	 (07-11)	 (07-11)	 (07-11)

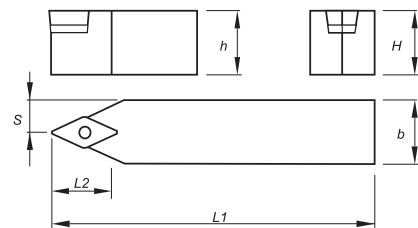
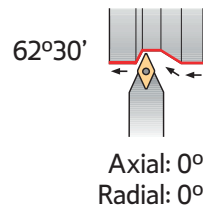





Order Code	Reference	Dimensions (mm)					Insert	Kg	Stock
		H=h	b	L1	L2	S			
212144200	SDNC N 0808 D07	8	8	60	16	4,0	DC.. 0702..	0,050	☉
212144300	SDNC N 1010 E07	10	10	70	16	5,0	DC.. 0702..	0,070	☉
212144400	SDNC N 1212 F07	12	12	80	18	6,0	DC.. 0702..	0,100	☉
212259700	SDNC N 1616 H11	16	16	100	22	8,0	DC.. 11T3..	0,200	☉
212144500	SDNC N 2020 K11	20	20	125	22	10,0	DC.. 11T3..	0,400	☉
212259800	SDNC N 2525 M11	25	25	150	22	12,5	DC.. 11T3..	0,700	☉

☉ Stock Items | Itens de stock

○ Available under request | Disponible sob consulta | Disponible bajo consulta



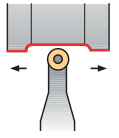

SPARE PARTS || Complementos | Repuestos

Cutter Reference	Shim	Shim Screw	Screw	Wrench
SDNC N 0808 D07	 -	 -	 P0250700	 XT07
SDNC N 1010 E07	-	-	P0250700	XT07
SDNC N 1212 F07	-	-	P0250700	XT07
SDNC N 1616 H11	CD110301	T05003500	P0351500	XT15-S35
SDNC N 2020 K11	CD110301	T05003500	P0351500	XT15-S35
SDNC N 2525 M11	CD110301	T05003500	P0351500	XT15-S35

(S) CENTER SCREW TOOLHOLDERS



Axial: 0°
Radial: 0°

Medium	Roughing to Medium	Roughing to Medium	Finishing to Fine Finishing
CP  (06)	..MT-ST  (08-10-12)	..MX-ST  (12)	LN  (06-08-12)

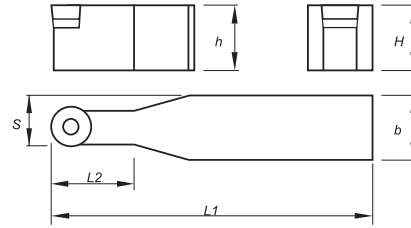

Order Code	Reference	Dimensions (mm)					Insert	Kg	Stock
		H=h	b	L1	L2	S			
212148500	SRDC N 1010 E06	10	10	70	10	8,0	RC.. 0602M0	0,070	⊗
212148600	SRDC N 1212 F06	12	12	80	12	11,0	RC.. 0602M0	0,100	⊗
212058700	SRDC N 1616 H06	16	16	100	16	13,0	RC.. 0602M0	0,200	⊗
212053400	SRDC N 2020 K06	20	20	125	20	15,0	RC.. 0602M0	0,400	⊗
212040000	SRDC N 2525 M06	25	25	150	25	17,5	RC.. 0602M0	0,700	⊗
212148700	SRDC N 1616 H08	16	16	100	16	13,0	RC.. 0803M0	0,200	⊗
212024400	SRDC N 2020 K08	20	20	125	20	15,0	RC.. 0803M1	0,400	⊗
212148800	SRDC N 2525 M08	25	25	150	25	17,5	RC.. 0803M2	0,700	⊗
212049500	SRDC N 2020 K10	20	20	125	22	15,0	RC.. 10T3M0	0,400	⊗
212040100	SRDC N 2525 M10	25	25	150	22	17,5	RC.. 10T3M0	0,700	⊗
212259900	SRDC N 2020 K12	20	20	125	28	16,0	RC.. 1204M0	0,400	⊗
212050800	SRDC N 2525 M12	25	25	150	28	18,5	RC.. 1204M0	0,700	⊗
212058800	SRDC N 3225 P12	32	25	170	28	18,5	RC.. 1204M0	0,900	⊗
212148900	SRDC N 3232 P12	32	32	170	28	22,0	RC.. 1204M0	1,200	⊗









⊗ Stock Items | Itens de stock

○ Available under request | Disponível sob consulta | Disponible bajo consulta







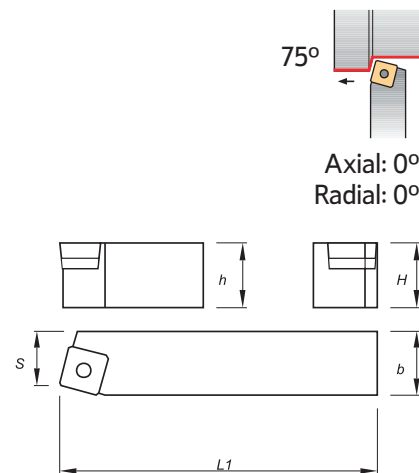

SPARE PARTS || Complementos | Repuestos

Cutter Reference	Shim	Shim Screw	Screw	Wrench
SRDC N 1010 E06	-	-	P0250700	XT07
SRDC N 1212 F06	-	-	P0250700	XT07
SRDC N 1616 H06	-	-	P0250700	XT07
SRDC N 2020 K06	-	-	P0250700	XT07
SRDC N 2525 M06	-	-	P0250700	XT07
SRDC N 1616 H08	-	-	P0300900	XT08
SRDC N 2020 K08	-	-	P0300900	XT08
SRDC N 2525 M08	-	-	P0300900	XT08
SRDC N 2020 K10	CR100301	T05003500	P0351500	XT15-S35
SRDC N 2525 M10	CR100301	T05003500	P0351500	XT15-S35
SRDC N 2020 K12	CR120301	T05003500	P0351500	XT15-S35
SRDC N 2525 M12	CR120301	T05003500	P0351500	XT15-S35
SRDC N 3225 P12	CR120301	T05003500	P0351500	XT15-S35
SRDC N 3232 P12	CR120301	T05003500	P0351500	XT15-S35

(S) CENTER SCREW TOOLHOLDERS

Finishing	Finishing	Finishing	Finishing
Flat	FP	FM	FK
 (09-12)	 (09)	 (09)	 (09)
Medium	Medium	Medium	Medium to Finishing
MP	MM	MK	LN
 (09-12)	 (09-12)	 (09-12)	 (09-12)







Order Code		Reference	Dimensions (mm)				Insert	Kg	Stock	
R	L		H=h	b	L1	S			R	L
212149100	212149000	SSBC R/L 1212 F09	12	12	80	11	SC.. 09T3..	0,100		
212045700	212149200	SSBC R/L 1616 H09	16	16	100	13	SC.. 09T3..	0,200		
212149400	212149300	SSBC R/L 2020 K12	20	20	125	17	SC.. 1204..	0,400		
212149600	212149500	SSBC R/L 2525 M12	25	25	150	22	SC.. 1204..	0,700		

 Stock Items | Itens de stock

 Available under request | Disponivel sob consulta | Disponible bajo consulta

SPARE PARTS || Complementos | Repuestos

Cutter Reference	Shim	Shim Screw	Screw	Wrench
SSBC R/L 1212 F09				
SSBC R/L 1212 F09	-	-	P0401100	XT15-S35
SSBC R/L 1616 H09	-	-	P0401100	XT15-S35
SSBC R/L 2020 K12	CS120400	T06004000	P0401400	XT15-S40
SSBC R/L 2525 M12	CS120400	T06004000	P0401400	XT15-S40

(S) CENTER SCREW TOOLHOLDERS

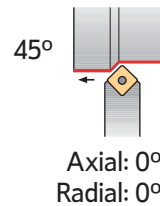

Finishing	Finishing	Finishing	Finishing
Flat (09-12)	FP (09)	FM (09)	FK (09)
Medium	Medium	Medium	Medium to Finishing
MP (09-12)	MM (09-12)	MK (09-12)	LN (09-12)

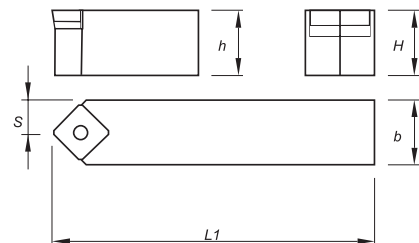

Order Code	Reference	Dimensions (mm)				Insert	Kg	Stock
		H=h	b	L1	S			
212149700	SSDC N 1212 F09	12	12	80	6,0	SC.. 09T3..	0,100	
212050900	SSDC N 1616 H09	16	16	100	8,0	SC.. 09T3..	0,200	
212046000	SSDC N 2020 K12	20	20	125	10,0	SC.. 1204..	0,400	
212076800	SSDC N 2525 M12	25	25	150	12,5	SC.. 1204..	0,700	









Stock Items | Itens de stock

Available under request | Disponível sob consulta | Disponible bajo consulta







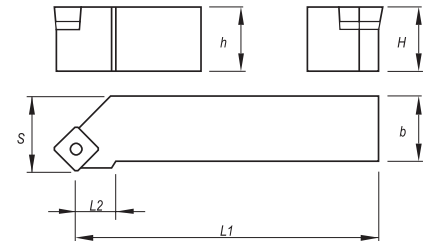
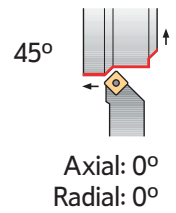

SPARE PARTS | Complementos | Repuestos

Cutter Reference	Shim 	Shim Screw 	Screw 	Wrench
SSDC N 1212 F09	-	-	P0401100	XT15-S35
SSDC N 1616 H09	-	-	P0401100	XT15-S35
SSDC N 2020 K12	CS120400	T06004000	P0401400	XT15-S40
SSDC N 2525 M12	CS120400	T06004000	P0401400	XT15-S40

(S) CENTER SCREW TOOLHOLDERS

Finishing	Finishing	Finishing	Finishing
Flat	FP	FM	FK
 (09-12)	 (09)	 (09)	 (09)
Medium	Medium	Medium	Medium to Finishing
MP	MM	MK	LN
 (09-12)	 (09-12)	 (09-12)	 (09-12)







Order Code		Reference	Dimensions (mm)					Insert	Kg	Stock	
R	L		H=h	b	L1	L2	S			R	L
212149900	212149800	SSSC R/L 1212 F09	12	12	80	11	16	SC.. 09T3..	0,100		
212150100	212150000	SSSC R/L 1616 H09	16	16	100	22	20	SC.. 09T3..	0,200		
212021900	212150200	SSSC R/L 2020 K12	20	20	125	22	25	SC.. 1204..	0,400		
212042700	212021800	SSSC R/L 2525 M12	25	25	150	22	32	SC.. 1204..	0,700		

 Stock Items | Itens de stock

 Available under request | Disponível sob consulta | Disponible bajo consulta







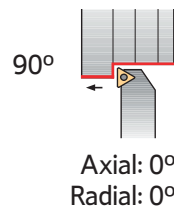

SPARE PARTS | Complementos | Repuestos

Cutter Reference	Shim	Shim Screw	Screw	Wrench
SSSC R/L 1212 F09				
SSSC R/L 1616 H09	-	-	P0401100	XT15-S35
SSSC R/L 2020 K12	CS120400	T06004000	P0401400	XT15-S40
SSSC R/L 2525 M12	CS120400	T06004000	P0401400	XT15-S40









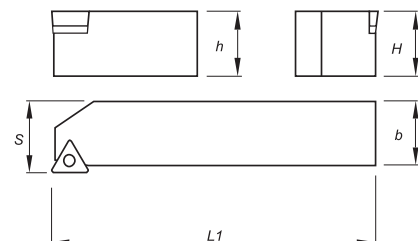





C
TURNING
Insert selection
Overview
Negative inserts
Positive inserts
PCBN & PCD inserts
Heavy turning
External Toolholders
Internal Toolholders
Automatic Lathes
Spare Parts
Technical Data

(S) CENTER SCREW TOOLHOLDERS



Finishing	Finishing	Finishing	Finishing
Flat  (09-11-16)	FP  (09-11-16)	FM  (09-11-16)	FK  (09-11-16)
Medium	Medium	Medium	Medium to Finishing
MP  (09-11-16)	MM  (09-11-16)	MK  (09-11-16)	LN  (11-16)







Order Code		Reference	Dimensions (mm)				Insert	Kg	Stock	
R	L		H=h	b	L1	S			R	L
212151400	212151300	STAC R/L 0808 D09	8	8	60	8,5	TC.. 0902..	0,050		
212151600	212151500	STAC R/L 1010 E09	10	10	70	10,5	TC.. 0902..	0,070		
212151800	212151700	STAC R/L 1212 F11	12	12	80	12,5	TC.. 1102..	0,100		
212152000	212151900	STAC R/L 1616 H11	16	16	100	16,5	TC.. 1102..	0,200		
212152200	212152100	STAC R/L 1616 H16	16	16	100	16,5	TC.. 16T3..	0,200		
212260000	212260100	STAC R/L 2020 K16	20	20	125	20,5	TC.. 16T3..	0,400		
212152600	212152400	STAC R/L 2525 M16	25	25	150	25,5	TC.. 16T3..	0,700		

 Stock Items | Itens de stock







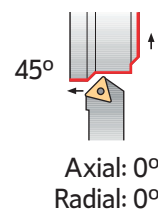

Available under request | Disponível sob consulta | Disponible bajo consulta

SPARE PARTS | Complementos | Repuestos









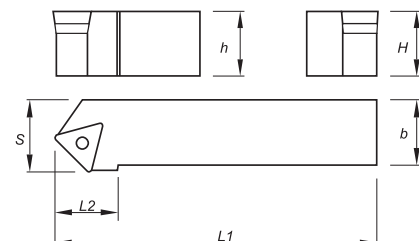







Cutter Reference	Shim	Shim Screw	Screw	Wrench
				
STAC R/L 0808 D09	-	-	P0220600	XT06
STAC R/L 1010 E09	-	-	P0220600	XT06
STAC R/L 1212 F11	-	-	P0250700	XT07
STAC R/L 1616 H11	-	-	P0250700	XT07
STAC R/L 1616 H16	CT160302	T05003500	P0351500	XT15-S35
STAC R/L 2020 K16	CT160302	T05003500	P0351500	XT15-S35
STAC R/L 2525 M16	CT160302	T05003500	P0351500	XT15-S35

(S) CENTER SCREW TOOLHOLDERS



Finishing	Finishing	Finishing	Finishing
Flat	FP	FM	FK
 (09-11-16)	 (09-11-16)	 (09-11-16)	 (09-11-16)
Medium	Medium	Medium	Medium to Finishing
MP	MM	MK	LN
 (09-11-16)	 (09-11-16)	 (09-11-16)	 (11-16)







Order Code		Reference	Dimensions (mm)					Insert	Kg	Stock	
R	L		H=h	b	L1	L2	S			R	L
212152800	212152700	STDC R/L 0808 D09	8	8	60	11	10	TC.. 0902..	0,050		
212153000	212152900	STDC R/L 1010 E09	10	10	70	11	11	TC.. 0902..	0,070		
212153200	212153100	STDC R/L 1212 F11	12	12	80	16	13	TC.. 1102..	0,100		
212153400	212153300	STDC R/L 1616 H11	16	16	100	16	17	TC.. 1102..	0,200		
212153600	212153500	STDC R/L 1212 F16	12	12	80	21	17	TC.. 16T3..	0,100		
212153800	212153700	STDC R/L 1616 H16	16	16	100	21	17	TC.. 16T3..	0,200		
212154000	212153900	STDC R/L 2020 K16	20	20	125	21	22	TC.. 16T3..	0,400		
212154200	212154100	STDC R/L 2525 M16	25	25	150	21	27	TC.. 16T3..	0,700		

 Stock Items | Itens de stock

 Available under request | Disponível sob consulta | Disponible bajo consulta







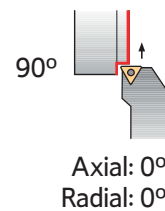

SPARE PARTS | Complementos | Repuestos

Cutter Reference	Shim	Shim Screw	Screw	Wrench
STDC R/L 0808 D09				
STDC R/L 1010 E09	-	-	P0220600	XT06
STDC R/L 1212 F11	-	-	P0250700	XT07
STDC R/L 1616 H11	-	-	P0250700	XT07
STDC R/L 1212 F16	-	-	P0401100	XT15-S35
STDC R/L 1616 H16	CT160302	T05003500	P0351500	XT15-S35
STDC R/L 2020 K16	CT160302	T05003500	P0351500	XT15-S35
STDC R/L 2525 M16	CT160302	T05003500	P0351500	XT15-S35









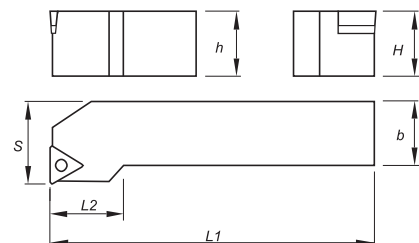







C
TURNING
Insert selection
Overview
Negative inserts
Positive inserts
PCBN & PCD inserts
Heavy turning
External Toolholders
Internal Toolholders
Automatic Lathes
Spare Parts
Technical Data

(S) CENTER SCREW TOOLHOLDERS



Finishing	Finishing	Finishing	Finishing
Flat  (09-11-16)	FP  (09-11-16)	FM  (09-11-16)	FK  (09-11-16)
Medium	Medium	Medium	Medium to Finishing
MP  (09-11-16)	MM  (09-11-16)	MK  (09-11-16)	LN  (11-16)







Order Code		Reference	Dimensions (mm)					Insert	Kg	Stock	
R	L		H=h	b	L1	L2	S			R	L
212154400	212154300	STFC R/L 0808 D09	8	8	60	16	10	TC.. 0902..	0,050		
212154600	212154500	STFC R/L 1010 E09	10	10	70	16	12	TC.. 0902..	0,070		
212154800	212154700	STFC R/L 1212 F11	12	12	80	18	16	TC.. 1102..	0,100		
212065800	212154900	STFC R/L 1616 H11	16	16	100	22	20	TC.. 1102..	0,200		
212155100	212155000	STFC R/L 1212 F16	12	12	80	18	16	TC.. 16T3..	0,100		
212056800	212155200	STFC R/L 1616 H16	16	16	100	22	20	TC.. 16T3..	0,200		
212056600	212155300	STFC R/L 2020 K16	20	20	125	22	25	TC.. 16T3..	0,400		
212155500	212155400	STFC R/L 2525 M16	25	25	150	22	32	TC.. 16T3..	0,700		

 Stock Items | Itens de stock







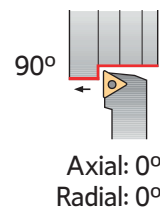

 Available under request | Disponível sob consulta | Disponible bajo consulta

SPARE PARTS | Complementos | Repuestos









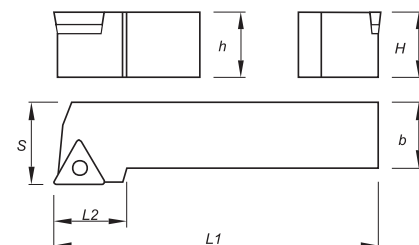







Cutter Reference	Shim 	Shim Screw 	Screw 	Wrench 
STFC R/L 0808 D09	-	-	P0220600	XT06
STFC R/L 1010 E09	-	-	P0220600	XT06
STFC R/L 1212 F11	-	-	P0250700	XT07
STFC R/L 1616 H11	-	-	P0250700	XT07
STFC R/L 1212 F16	-	-	P0401100	XT15-S35
STFC R/L 1616 H16	CT160302	T05003500	P0351500	XT15-S35
STFC R/L 2020 K16	CT160302	T05003500	P0351500	XT15-S35
STFC R/L 2525 M16	CT160302	T05003500	P0351500	XT15-S35

(S) CENTER SCREW TOOLHOLDERS



Finishing	Finishing	Finishing	Finishing
Flat	FP	FM	FK
 (09-11-16)	 (09-11-16)	 (09-11-16)	 (09-11-16)
Medium	Medium	Medium	Medium to Finishing
MP	MM	MK	LN
 (09-11-16)	 (09-11-16)	 (09-11-16)	 (11-16)







Order Code		Reference	Dimensions (mm)					Insert	Kg	Stock	
R	L		H=h	b	L1	L2	S			R	L
212155700	212155600	STGC R/L 0808 D09	8	8	60	16	10	TC.. 0902..	0,050		
212155900	212155800	STGC R/L 1010 E09	10	10	70	16	12	TC.. 0902..	0,070		
212156100	212156000	STGC R/L 1212 F11	12	12	80	18	16	TC.. 1102..	0,100		
212046100	212156200	STGC R/L 1616 H11	16	16	100	22	20	TC.. 1102..	0,200		
212156400	212156300	STGC R/L 1212 F16	12	12	80	18	16	TC.. 16T3..	0,100		
212156600	212156500	STGC R/L 1616 H16	16	16	100	22	20	TC.. 16T3..	0,200		
212156800	212156700	STGC R/L 2020 K16	20	20	125	22	25	TC.. 16T3..	0,400		
212157000	212156900	STGC R/L 2525 M16	25	25	150	22	32	TC.. 16T3..	0,700		

 Stock Items | Itens de stock

 Available under request | Disponible sob consulta | Disponible bajo consulta









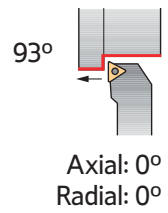

SPARE PARTS | Complementos | Repuestos

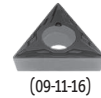
Cutter Reference	Shim	Shim Screw	Screw	Wrench
STGC R/L 0808 D09				
STGC R/L 1010 E09	-	-	P0220600	XT06
STGC R/L 1212 F11	-	-	P0250700	XT07
STGC R/L 1616 H11	-	-	P0250700	XT07
STGC R/L 1212 F16	-	-	P0401100	XT15-S35
STGC R/L 1616 H16	CT160302	T05003500	P0351500	XT15-S35
STGC R/L 2020 K16	CT160302	T05003500	P0351500	XT15-S35
STGC R/L 2525 M16	CT160302	T05003500	P0351500	XT15-S35









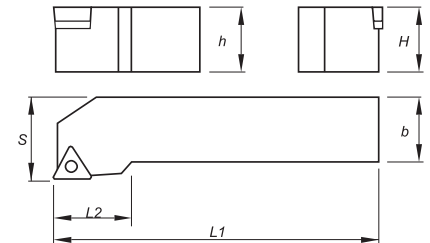







C
TURNING
Insert selection
Overview
Negative inserts
Positive inserts
PCBN & PCD inserts
Heavy turning
External Toolholders
Internal Toolholders
Automatic Lathes
Spare Parts
Technical Data

(S) CENTER SCREW TOOLHOLDERS



Finishing	Finishing	Finishing	Finishing	Finishing wiper
Flat  (09-11-16)	FP  (09-11-16)	FM  (09-11-16)	FK  (09-11-16)	FW  (09-11-16)
Medium	Medium	Medium	Medium to Finishing wiper	Medium to Finishing
MP  (09-11-16)	MM  (09-11-16)	MK  (09-11-16)	MW  (11-16)	LN  (11-16)







Order Code		Reference	Dimensions (mm)					Insert	Kg	Stock	
R	L		H=h	b	L1	L2	S			R	L
212157200	212157100	STJC R/L 0808 D09	8	8	60	16	10	TC.. 0902..	0,050		
212157400	212157300	STJC R/L 1010 E09	10	10	70	16	12	TC.. 0902..	0,070		
212157600	212157500	STJC R/L 1212 F11	12	12	80	18	16	TC.. 1102..	0,100		
212035400	212035500	STJC R/L 1616 H11	16	16	100	22	20	TC.. 1102..	0,200		
212157800	212157700	STJC R/L 1212 F16	12	12	80	18	16	TC.. 16T3..	0,100		
212035600	212035700	STJC R/L 1616 H16	16	16	100	22	20	TC.. 16T3..	0,200		
212036300	212031000	STJC R/L 2020 K16	20	20	125	22	25	TC.. 16T3..	0,400		
212038600	212038700	STJC R/L 2525 M16	25	25	150	22	32	TC.. 16T3..	0,700		









 Stock Items | Itens de stock

 Available under request | Disponível sob consulta | Disponible bajo consulta









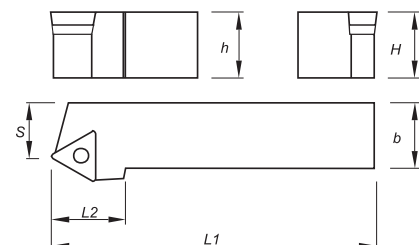
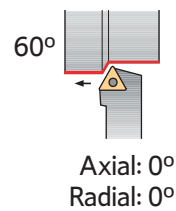







SPARE PARTS | Complementos | Repuestos

Cutter Reference	Shim	Shim Screw	Screw	Wrench
				
STJC R/L 0808 D09	-	-	P0220600	XT06
STJC R/L 1010 E09	-	-	P0220600	XT06
STJC R/L 1212 F11	-	-	P0250700	XT07
STJC R/L 1616 H11	-	-	P0250700	XT07
STJC R/L 1212 F16	-	-	P0401100	XT15-S35
STJC R/L 1616 H16	CT160302	T05003500	P0351500	XT15-S35
STJC R/L 2020 K16	CT160302	T05003500	P0351500	XT15-S35
STJC R/L 2525 M16	CT160302	T05003500	P0351500	XT15-S35

(S) CENTER SCREW TOOLHOLDERS

Finishing	Finishing	Finishing	Finishing
Flat	FP	FM	FK
 (09-11-16)	 (09-11-16)	 (09-11-16)	 (09-11-16)
Medium	Medium	Medium	Medium to Finishing
MP	MM	MK	LN
 (09-11-16)	 (09-11-16)	 (09-11-16)	 (11-16)







Order Code		Reference	Dimensions (mm)					Insert	Kg	Stock	
R	L		H=h	b	L1	L2	S			R	L
212158000	212157900	STTC R/L 0808 D09	8	8	60	16	7	TC.. 0902..	0,050		
212158200	212158100	STTC R/L 1010 E09	10	10	70	16	9	TC.. 0902..	0,070		
212158400	212158300	STTC R/L 1212 F11	12	12	80	18	11	TC.. 1102..	0,100		
212047500	212158500	STTC R/L 1616 H11	16	16	100	18	13	TC.. 1102..	0,200		
212158700	212158600	STTC R/L 1212 F16	12	12	80	22	11	TC.. 16T3..	0,100		
212158900	212158800	STTC R/L 1616 H16	16	16	100	22	13	TC.. 16T3..	0,200		
212159100	212159000	STTC R/L 2020 K16	20	20	125	22	17	TC.. 16T3..	0,400		
212159300	212159200	STTC R/L 2525 M16	25	25	150	22	22	TC.. 16T3..	0,700		

 Stock Items | Itens de stock







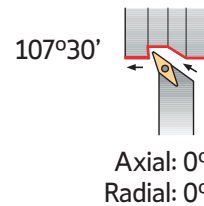

 Available under request | Disponível sob consulta | Disponible bajo consulta

SPARE PARTS || Complementos | Repuestos









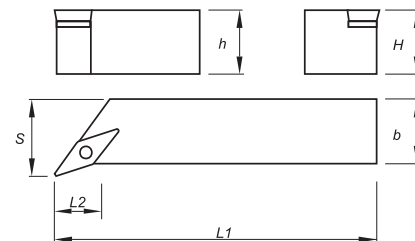

Cutter Reference	Shim	Shim Screw	Screw	Wrench
STTC R/L 0808 D09				
STTC R/L 1010 E09	-	-	P0220600	XT06
STTC R/L 1212 F11	-	-	P0250700	XT07
STTC R/L 1616 H11	-	-	P0250700	XT07
STTC R/L 1212 F16	-	-	P0401100	XT15-S35
STTC R/L 1616 H16	CT160302	T05003500	P0351500	XT15-S35
STTC R/L 2020 K16	CT160302	T05003500	P0351500	XT15-S35
STTC R/L 2525 M16	CT160302	T05003500	P0351500	XT15-S35

(S) CENTER SCREW TOOLHOLDERS



Finishing	Finishing	Finishing	Finishing
Flat	FP	FM	FK
 (16)	 (16)	 (16)	 (16)
Medium	Medium	Medium	Medium to Finishing
MP	MM	MK	LN
 (16)	 (16)	 (16)	 (16-22)



Order Code		Reference	Dimensions (mm)					Insert	Kg	Stock	
R	L		H=h	b	L1	L2	S			R	L
212161000	212160900	SVHC R/L 2020 K16	20	20	125	15,4	25	VC.. 1604..	0,400		
212161200	212161100	SVHC R/L 2525 M16	25	25	150	21,0	32	VC.. 1604..	0,700		
212161400	212161300	SVHC R/L 3225 P16	32	25	170	21,0	32	VC.. 1604..	0,900		
212161500	212161600	SVHC R/L 2525 M22	25	25	150	19,6	32	VC.. 2205..	0,700		
212161700	212161800	SVHC R/L 3225 P22	32	25	170	19,6	32	VC.. 2205..	0,900		

 Stock Items | Itens de stock





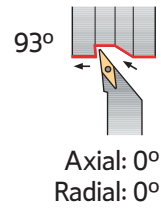

 Available under request | Disponível sob consulta | Disponible bajo consulta

SPARE PARTS || Complementos | Repuestos





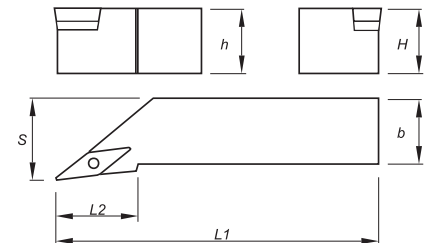

Cutter Reference	Shim	Shim Screw	Screw	Wrench
SVHC R/L 2020 K16	 CV160300	 T05003500	 P0351500	 XT15-S35
SVHC R/L 2525 M16	CV160300	T05003500	P0351500	XT15-S35
SVHC R/L 3225 P16	CV160300	T05003500	P0351500	XT15-S35
SVHC R/L 2525 M22	CV220400	T06004000	P0401400	XT20-S40
SVHC R/L 3225 P22	CV220400	T06004000	P0401400	XT20-S40

(S) CENTER SCREW TOOLHOLDERS



Finishing	Finishing	Finishing	Finishing
Flat	FP	FM	FK
 (16)	 (16)	 (16)	 (16)
Medium	Medium	Medium	
MP	MM	MK	
 (16)	 (16)	 (16)	



Order Code		Reference	Dimensions (mm)					Insert	Kg	Stock	
R	L		H=h	b	L1	L2	S			R	L
212055300	212363000	SVJB R/L 2020 K16	20	20	125	37	25	VB.. 1604..	0,400		
212022200	212022000	SVJB R/L 2525 M16	25	25	150	37	32	VB.. 1604..	0,700		
212022300	212022100	SVJB R/L 3225 P16	32	25	170	37	32	VB.. 1604..	0,900		

 Stock Items | Itens de stock







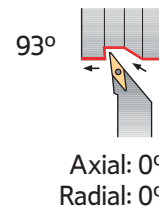

 Available under request | Disponível sob consulta | Disponible bajo consulta

SPARE PARTS || Complementos | Repuestos









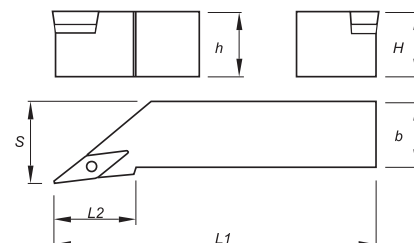





Cutter Reference	Shim	Shim Screw	Screw	Wrench
SVJB R/L 2020 K16	 CV160300	 T05003500	 P0351500	 XT15-S35
SVJB R/L 2525 M16	 CV160300	 T05003500	 P0351500	 XT15-S35
SVJB R/L 3225 P16	 CV160300	 T05003500	 P0351500	 XT15-S35

(S) CENTER SCREW TOOLHOLDERS



Finishing	Finishing	Finishing	Finishing
Flat	FP	FM	FK
 (11-16)	 (11-16)	 (11-16)	 (11-16)
Medium	Medium	Medium	Medium to Finishing
MP	MM	MK	LN
 (11-16)	 (11-16)	 (11-16)	 (11-16)





Order Code		Reference	Dimensions (mm)					Insert	Kg	Stock	
R	L		H=h	b	L1	L2	S			R	L
212161900	212162000	SVJC R/L 1212 F11	12	12	80	25	16	VC.. 1103..	0,100		
212056400	212162100	SVJC R/L 1616 H11	16	16	100	25	20	VC.. 1103..	0,200		
212162200	212162300	SVJC R/L 2020 K11	20	20	125	25	25	VC.. 1103..	0,400		
212392400	212420900	SVJC R/L 2525 M11	25	25	150	28	32	VC.. 1103..	0,700		
212031100	212031200	SVJC R/L 2020 K16	20	20	125	37	25	VC.. 1604..	0,400		
212031300	212031400	SVJC R/L 2525 M16	25	25	150	37	32	VC.. 1604..	0,700		
212162500	212162400	SVJC R/L 3225 P16	32	25	170	37	32	VC.. 1604..	0,900		

 Stock Items | Itens de stock







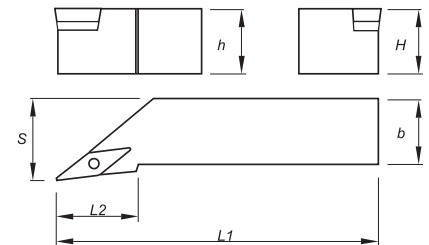
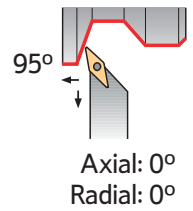

 Available under request | Disponível sob consulta | Disponible bajo consulta

SPARE PARTS || Complementos | Repuestos

Cutter Reference	Shim	Shim Screw	Screw	Wrench
SVJC R/L 1212 F11		-	-	
SVJC R/L 1616 H11	-	-	P0250700	XT07
SVJC R/L 2020 K11	-	-	P0250700	XT07
SVJC R/L 2525 M11	-	-	P0250700	XT07
SVJC R/L 2020 K16	CV160300	T05003500	P0351500	XT15-S35
SVJC R/L 2525 M16	CV160300	T05003500	P0351500	XT15-S35
SVJC R/L 3225 P16	CV160300	T05003500	P0351500	XT15-S35

(S) CENTER SCREW TOOLHOLDERS



Order Code		Reference	Dimensions (mm)					Insert	Kg	Stock	
R	L		H=h	b	L1	L2	S			R	L
212041900	212162600	SVLC R/L 1212 G13	12	12	90	25	16	VCGT 1303..	0,100		
212162800	212162700	SVLC R/L 1616 H13	16	16	100	25	20	VCGT 1303..	0,200		
212163000	212162900	SVLC R/L 2020 K13	20	20	125	28	25	VCGT 1303..	0,400		
212163200	212163100	SVLC R/L 2525 M13	25	25	150	30	32	VCGT 1303..	0,700		

 Stock Items | Itens de stock





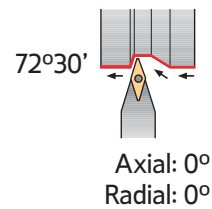

 Available under request | Disponível sob consulta | Disponible bajo consulta

SPARE PARTS | Complementos | Repuestos



Cutter Reference	Screw	Wrench
		
SVLC R/L 1212 G13	P0300900	XT08
SVLC R/L 1616 H13	P0300900	XT08
SVLC R/L 2020 K13	P0300900	XT08
SVLC R/L 2525 M13	P0300900	XT08

(S) CENTER SCREW TOOLHOLDERS

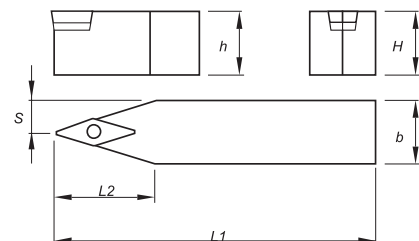

Finishing	Finishing	Finishing	Finishing
Flat	FP	FM	FK
			
(16)	(16)	(16)	(16)
Medium	Medium	Medium	
MP	MM	MK	
			
(16)	(16)	(16)	





Order Code	Reference	Dimensions (mm)					Insert	Kg	Stock
		H=h	b	L1	L2	S			
212260200	SVVB N 2020 K16	20	20	125	37	10,6	VB.. 1604..	0,400	
212169500	SVVB N 2525 M16	25	25	150	37	13,1	VB.. 1604..	0,700	
212260300	SVVB N 3225 P16	32	25	170	37	13,1	VB.. 1604..	0,900	









 Stock Items | Itens de stock

 Available under request | Disponível sob consulta | Disponible bajo consulta





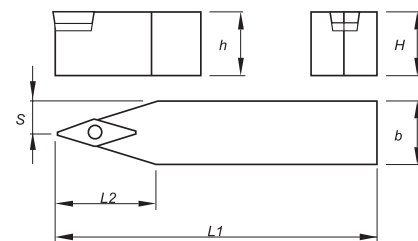
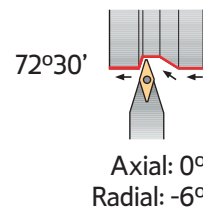

SPARE PARTS || Complementos | Repuestos

Cutter Reference	Shim	Shim Screw	Screw	Wrench
SVVB N 2020 K16				
SVVB N 2525 M16	CV160300	T05003500	P0351500	XT15-S35
SVVB N 3225 P16	CV160300	T05003500	P0351500	XT15-S35

(S) CENTER SCREW TOOLHOLDERS

Finishing	Finishing	Finishing	Finishing
Flat	FP	FM	FK
			
(11-16)	(11-16)	(11-16)	(11-16)
Medium	Medium	Medium	Medium to Finishing
MP	MM	MK	LN
			
(11-16)	(11-16)	(11-16)	(11-16)







Order Code	Reference	Dimensions (mm)					Insert	Kg	Stock
		H=h	b	L1	L2	S			
212163300	SVVC N 1212 F11	12	12	80	25	6,6	VC.. 1103..	0,100	
212163400	SVVC N 1616 H11	16	16	100	25	8,6	VC.. 1103..	0,200	
212163500	SVVC N 2020 K11	20	20	125	25	10,6	VC.. 1103..	0,400	
212042500	SVVC N 2020 K16	20	20	125	37	10,6	VC.. 1604..	0,400	
212163600	SVVC N 2525 M16	25	25	150	37	13,1	VC.. 1604..	0,700	
212022400	SVVC N 3225 P16	32	25	170	37	13,1	VC.. 1604..	0,900	

 Stock Items | Itens de stock







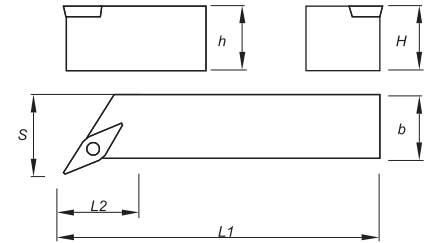
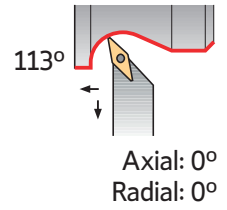

 Available under request | Disponível sob consulta | Disponible bajo consulta

SPARE PARTS || Complementos | Repuestos

Cutter Reference	Shim	Shim Screw	Screw	Wrench
				
SVVC N 1212 F11	-	-	P0250700	XT07
SVVC N 1616 H11	-	-	P0250700	XT07
SVVC N 2020 K11	-	-	P0250700	XT07
SVVC N 2020 K16	CV160300	T05003500	P0351500	XT15-S35
SVVC N 2525 M16	CV160300	T05003500	P0351500	XT15-S35
SVVC N 3225 P16	CV160300	T05003500	P0351500	XT15-S35

(S) CENTER SCREW TOOLHOLDERS



Order Code		Reference	Dimensions (mm)					Insert	Kg	Stock	
R	L		H=h	b	L1	L2	S			R	L
212163800	212163700	SVXC R/L 1212 G13	12	12	90	11,5	16	VCGT 1303..	0,100		
212164000	212163900	SVXC R/L 1616 H13	16	16	100	13,8	20	VCGT 1303..	0,200		
212164200	212164100	SVXC R/L 2020 K13	20	20	125	10,4	25	VCGT 1303..	0,400		
212164400	212164300	SVXC R/L 2525 M13	25	25	150	20,2	32	VCGT 1303..	0,700		

 Stock Items | Itens de stock







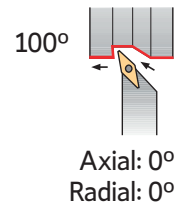

 Available under request | Disponível sob consulta | Disponible bajo consulta

SPARE PARTS | Complementos | Repuestos





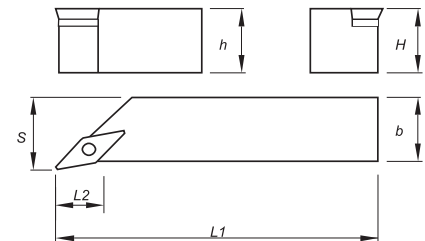

Cutter Reference	Screw	Wrench
		
SVXC R/L 1212 G13	P0300900	XT08
SVXC R/L 1616 H13	P0300900	XT08
SVXC R/L 2020 K13	P0300900	XT08
SVXC R/L 2525 M13	P0300900	XT08

(S) CENTER SCREW TOOLHOLDERS



Finishing	Finishing	Finishing	Finishing
Flat	FP	FM	FK
 (16)	 (16)	 (16)	 (16)
Medium	Medium	Medium	Medium to Finishing
MP	MM	MK	LN
 (16)	 (16)	 (16)	 (16)



Order Code		Reference	Dimensions (mm)					Insert	Kg	Stock	
R	L		H=h	b	L1	L2	S			R	L
212164600	212164500	SVZC R/L 2020 K16	20	20	125	25,7	25	VC..1604..	0,400		
212164700	212044500	SVZC R/L 2525 M16	25	25	150	28,5	32	VC..1604..	0,700		
212164900	212164800	SVZC R/L 3225 P16	32	25	170	28,5	32	VC..1604..	0,900		

 Stock Items | Itens de stock

Available under request | Disponível sob consulta | Disponible bajo consulta

SPARE PARTS | Complementos | Repuestos



Cutter Reference	Shim	Shim Screw	Screw	Wrench
SVZC R/L 2020 K16	 CV160300	 T05003500	 P0351500	 XT15-S35
SVZC R/L 2525 M16	 CV160300	 T05003500	 P0351500	 XT15-S35
SVZC R/L 3225 P16	 CV160300	 T05003500	 P0351500	 XT15-S35

CODE KEY FOR INTERNAL TURNING TOOLHOLDERS

Sistema De Codificação Para Suportes De Torneamento Interno (ISO) | Codificación De Herramientas De Torneado Interior (ISO)

S	25	T	S	D	U	C	R	11	-	BT
1	2	3	4	5	6	7	8	9		10

1 - Bar Type

A	Steel shank with internal coolant		
E	Anti-vibration shank (heavy metal) with internal coolant		
S	Steel shank		

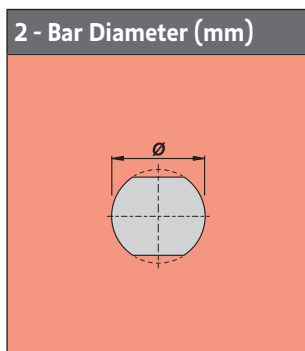

3 - Bar Length (mm)

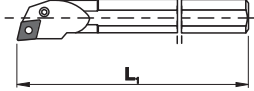
	H	100	T	300
	J	110	U	350
	K	125	V	400
	L	140	W	450
	M	150	Y	500
	Q	180	X	Special
	R	200		
	S	250		

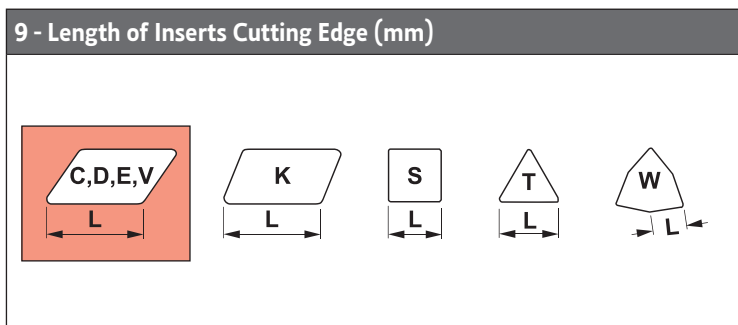
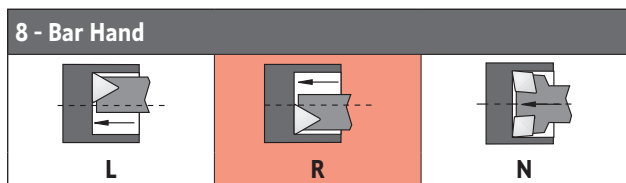
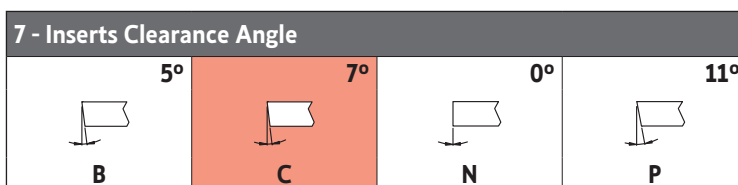
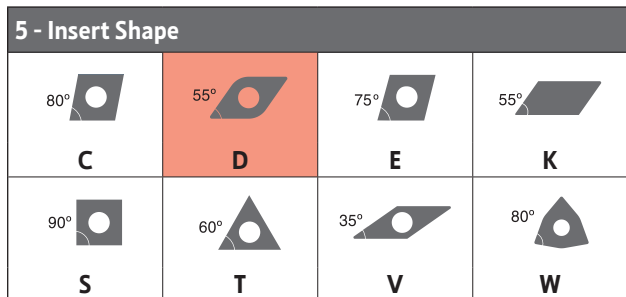
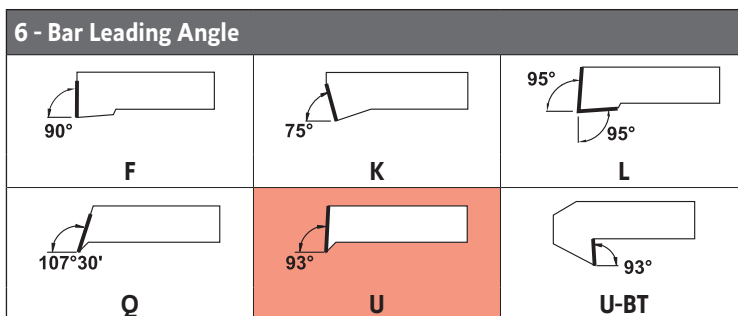
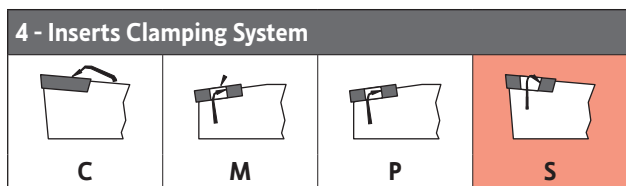

10 - Manufacturer's Option



- C - 612 | Top Clamp Toolholders (C)
- C - 617 | Dimple Lock Toolholders (D)
- C - 620 | Wedge Clamp (M) & Double Lock (M-K) Toolholders
- C - 630 | Lever Lock Toolholders (P)
- C - 644 | Center Screw Toolholders (S)
- C - 668 | Anti-vibration tools
- C - 679 | Internal Toolholders set

INTERNAL TURNING

CLAMPING SYSTEMS FOR INTERNAL TOOLHOLDERS

Sistemas De Fixação Para Ferramentas De Torneamento Interno | Sistemas De Fijación Para Herramientas De Torneado Interior

(C) TOP CLAMP SYSTEM

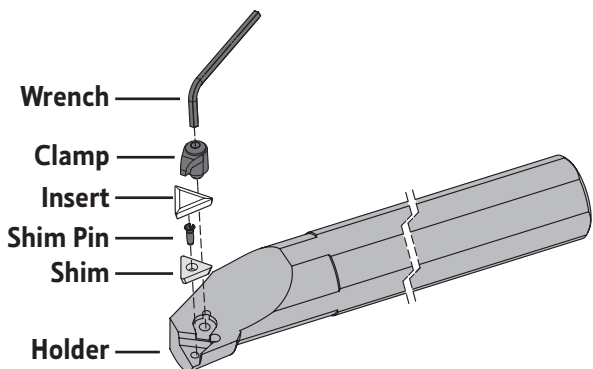

(D) DIMPLE LOCK SYSTEM

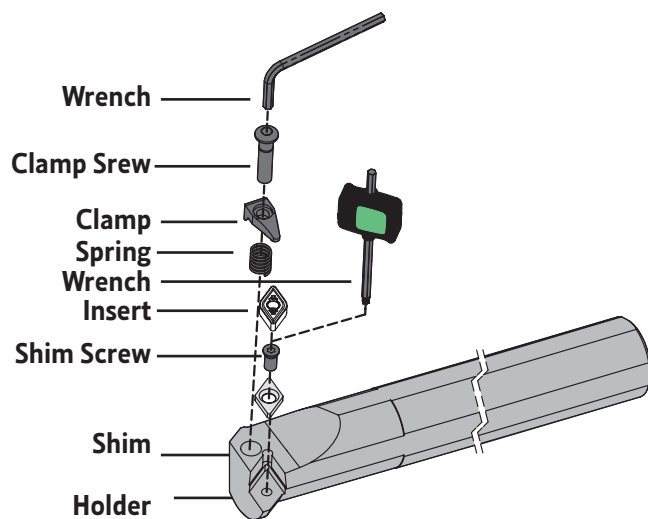

(M) WEDGE CLAMP SYSTEM

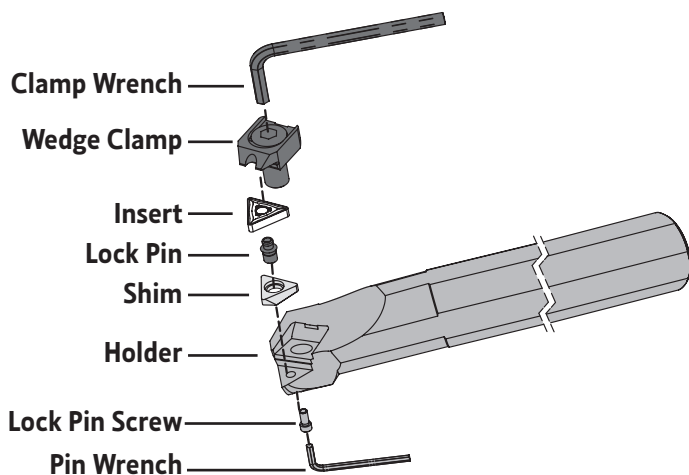

(P) LEVER LOCK SYSTEM

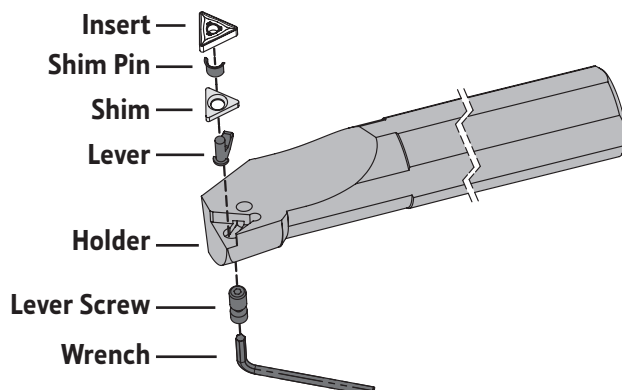

(M-K) DOUBLE LOCK SYSTEM

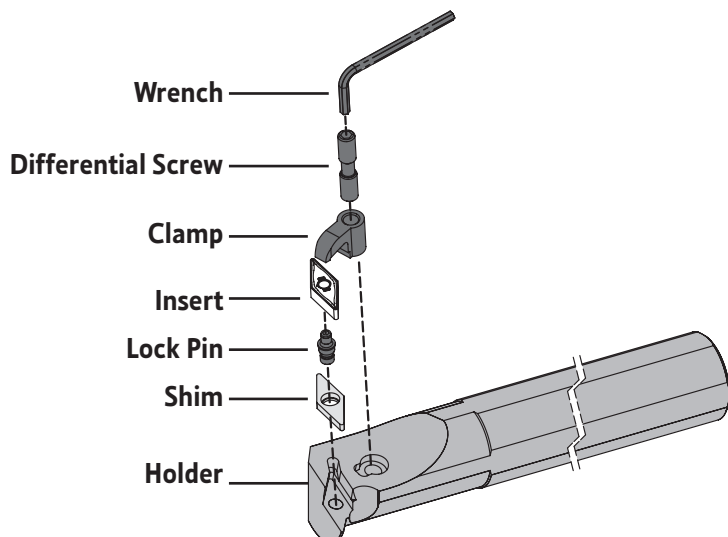

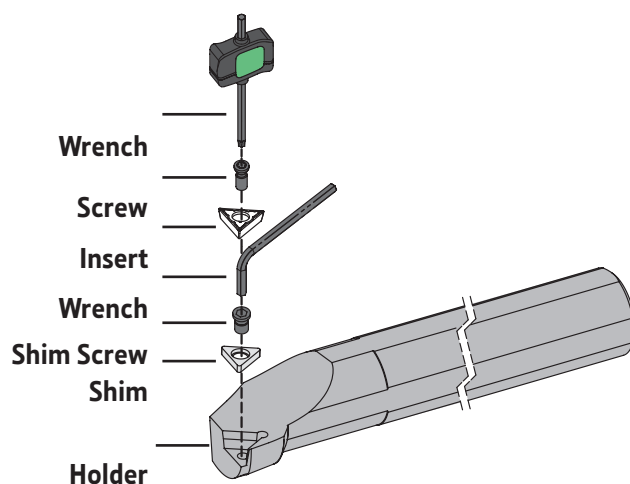

(S) CENTER SCREW SYSTEM



TURNING
Insert selection
Overview
Negative inserts
Positive inserts
PCBN & PCD inserts
Heavy turning
External Toolholders
Internal Toolholders
Automatic Lathes
Spare Parts
Technical Data

SUITABLE CLAMPING SYSTEM DEFINITION

Definição do sistema de fixação | Definición del sistema de Fijación

Insert Shape & page		Operation	Longitudinal turning	Profiling	Facing
					
Negative inserts	(C) TOP CLAMP SYSTEM	●	●	●	
	(D) DIMPLE LOCK SYSTEM	● ●	●		
	(M) WEDGE CLAMP SYSTEM	●	●	●	
	(P) LEVER LOCK SYSTEM	● ●	●	●	●
Positive inserts	(C) TOP CLAMP SYSTEM	●			
	(S) CENTER SCREW SYSTEM	● ●	● ●	● ●	● ●
			● ● Recommended Insert Shape	● Alternative Insert Shape	



TURNING

Insert selection

Overview

Negative inserts

Positive inserts

PCBN & PCD inserts

Heavy turning

External Toolholders

Internal Toolholders

Automatic Lathes

Spare Parts

Technical Data

(C) TOP CLAMP SYSTEM

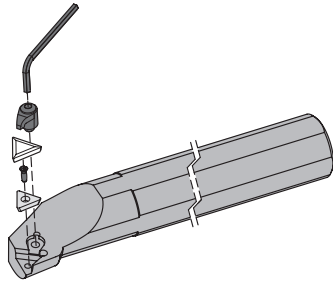

CKUN 93°	CSKP 75°	CTFP 90°	CTUP 93°
PAGE C - 613 KNUX 1604..	PAGE C - 614 SP. 0903.. SP. 1203.. SP. 1904..	PAGE C - 615 TP. 0903.. ... TP. 2204..	PAGE C - 616 TP. 0903.. ... TP. 2204..

(C) TOP CLAMP TOOLHOLDERS

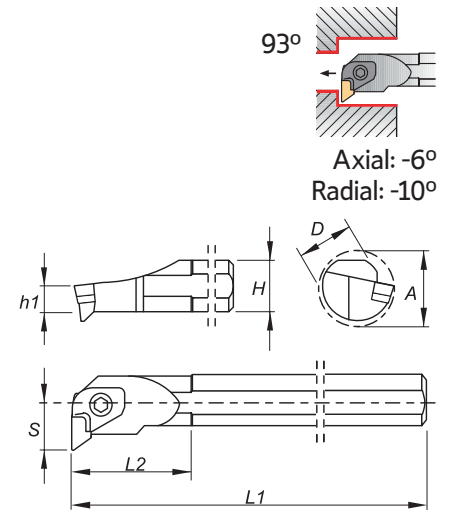
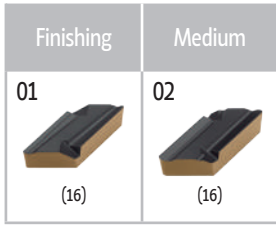

Order Code		Reference	Dimensions (mm)							Insert	Kg	Stock	
R	L		D	H	h1	L1	L2	S	A			R	L
212038300	212028200	S25T CKUN R/L 16	25	23	11,5	300	50	20,5	37	KNUX 1604..	0,700	⊗	⊗
212028300	212028400	S32U CKUN R/L 16	32	30	15,0	350	54	22,0	39	KNUX 1604..	2,050	○	○
212329300	212329400	S40V CKUN R/L 16	40	37	18,5	400	60	27,0	48	KNUX 1604..	3,750	○	○
212329500	212329600	S50W CKUN R/L 16	50	47	23,5	450	65	35,0	61	KNUX 1604..	6,500	○	○

⊗ Stock Items | Itens de stock



○ Available under request | Disponível sob consulta | Disponible bajo consulta

SPARE PARTS || Complementos | Repuestos

Cutter Reference	Order separately						
	Shim	Shim Pin	Shim Pin Punch	Spring	Clamp	Screw	Wrench
S25T CKUN R 16	-	-	BF04806	M09513	GAW1401	DW142600	SS40
S32U CKUN R 16	CK160501	BE03000	BF04808	M09513	GAW1401	DW142600	SS40
S40V CKUN R 16	CK160501	BE03000	BF04815	M09513	GAW1401	DW142600	SS40
S50W CKUN R 16	CK160501	BE03000	BF04815	M09513	GAW1401	DW142600	SS40
S25T CKUN L 16	-	-	BF04806	M09513	GAW1400	DW142600	SS40
S32U CKUN L 16	CK160500	BE03000	BF04808	M09513	GAW1400	DW142600	SS40
S40V CKUN L 16	CK160500	BE03000	BF04815	M09513	GAW1400	DW142600	SS40
S50W CKUN L 16	CK160500	BE03000	BF04815	M09513	GAW1400	DW142600	SS40

C
TURNING
Insert selection
Overview
Negative inserts
Positive inserts
PCBN & PCD inserts
Heavy turning
External Toolholders
Internal Toolholders
Automatic Lathes
Spare Parts
Technical Data





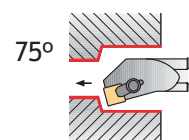



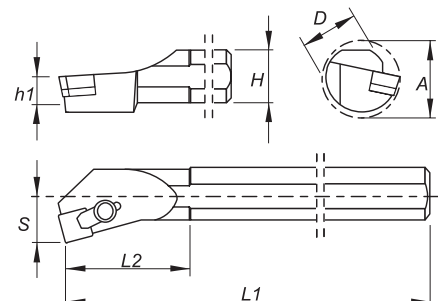





(C) TOP CLAMP TOOLHOLDERS

Medium to Finishing	Finishing to Fine Finishing	Medium
Flat  (09-12-19)	12  (09-12)	13  (09-12)



Axial: 6,5°
Radial: -1,25°



Order Code		Reference	Dimensions (mm)							Insert	Kg	Stock	
R	L		D	H	h1	L1	L2	S	A			R	L
212027500	212027600	S16R CSKP R/L 09	16	15	7,5	200	30	11	20	SP.. 0903..	0,300		
212027700	212027800	S20S CSKP R/L 09	20	18	9,0	250	35	13	24	SP.. 0903..	0,550		
212329700	212027900	S25T CSKP R/L 12	25	23	11,5	300	40	17	31	SP.. 1203..	1,050		
212028000	212028100	S32U CSKP R/L 12	32	30	15,0	350	50	22	39	SP.. 1203..	2,050		
212329800	212329900	S40V CSKP R/L 12	40	37	18,5	400	60	27	48	SP.. 1203..	3,650		
212330000	212330100	S50W CSKP R/L 12	50	47	23,5	450	65	35	61	SP.. 1203..	6,450		
212330200	212330300	S50W CSKP R/L 19	50	47	23,5	450	65	35	61	SP.. 1904..	6,400		

 Stock Items | Itens de stock



 Available under request | Disponível sob consulta | Disponible bajo consulta

SPARE PARTS || Complementos | Repuestos









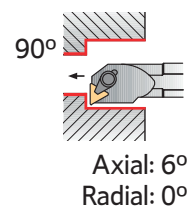
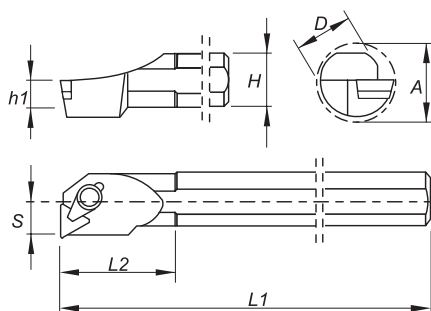

















Complementary Accessories - Flat Inserts

Cutter Reference	Shim	Shim Pin	Clamp	Wrench	Clamp	Chip Breaker 1	Chip Breaker 2
S16R CSKP R/L 09							
S16R CSKP R/L 09	-	-	GS05000	SS25	-	QCS0900	-
S20S CSKP R/L 09	-	-	GS05000	SS25	-	QCS1200	QCS1201
S25T CSKP R/L 12	-	-	GS06001	SS30	GS06003	QCS1200	QCS1201
S32U CSKP R/L 12	CS120300	BE02100	GS06001	SS30	GS06003	QCS1200	QCS1201
S40V CSKP R/L 12	CS120300	BE02100	GS06001	SS30	GS06003	QCS1200	QCS1201
S50W CSKP R/L 12	CS120300	BE02100	GS06001	SS30	GS06003	QCS1200	QCS1201
S50W CSKP R/L 19	CS190300	BE03000	GS08000	SS40	GS08001	QCS1900	QCS1901

(C) TOP CLAMP TOOLHOLDERS

Medium to Finishing	Finishing to Fine Finishing	Medium
Flat  (11-16-22)	12  (09-11-16)	13  (09-11-16-22)









Order Code		Reference	Dimensions (mm)							Insert	Kg	Stock	
R	L		D	H	h1	L1	L2	S	A			R	L
212330400	212330500	S10M CTFP R/L 09	10	9	4,5	150	25	7	13	TP.. 0902..	0,060		
212330600	212330700	S12M CTFP R/L 09	12	11	5,5	150	25	9	16	TP.. 0902..	0,150		
212170200	212330800	S12M CTFP R/L 11	12	11	5,5	150	25	9	16	TP.. 1103..	0,150		
212026800	212026900	S16R CTFP R/L 11	16	15	7,5	200	30	11	20	TP.. 1103..	0,300		
212027000	212027100	S20S CTFP R/L 11	20	18	9,0	250	35	13	24	TP.. 1103..	0,550		
212330900	212331000	S16R CTFP R/L 16	16	15	7,5	200	30	11	20	TP.. 1603..	0,300		
212331100	212331200	S20S CTFP R/L 16	20	18	9,0	250	35	13	24	TP.. 1603..	0,550		
212036700	212027200	S25T CTFP R/L 16	25	23	11,5	300	40	17	31	TP.. 1603..	0,700		
212027300	212027400	S32U CTFP R/L 16	32	30	15,0	350	50	22	39	TP.. 1603..	2,050		
212331300	212331700	S40V CTFP R/L 16	40	37	18,5	400	60	27	48	TP.. 1603..	3,750		
212331800	212331900	S50W CTFP R/L 16	50	47	23,5	450	65	35	61	TP.. 1603..	6,500		
212021300	212332000	S40V CTFP R/L 22	40	37	18,5	400	60	27	48	TP.. 2204..	3,750		
212332100	212332200	S50W CTFP R/L 22	50	47	23,5	450	65	35	61	TP.. 2204..	6,500		

 Stock Items | Itens de stock



 Available under request | Disponível sob consulta | Disponible bajo consulta

SPARE PARTS | Complementos | Repuestos









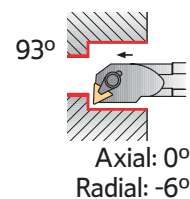
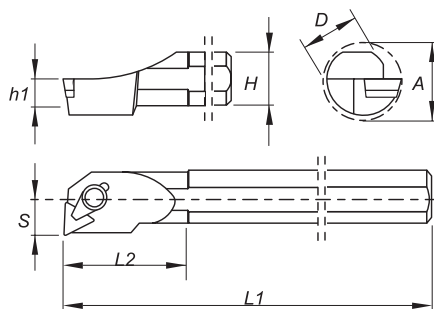

















Complementary Accessories - Flat Inserts

Cutter Reference	Shim	Shim Pin	Clamp	Wrench	Clamp	Chip Breaker 1	Chip Breaker 2
							
S10M CTFP R/L 09	-	-	GS03000	SS15	-	-	-
S12M CTFP R/L 09	-	-	GS03000	SS15	-	-	-
S12M CTFP R/L 11	-	-	GS04000	SS25	-	-	-
S16R CTFP R/L 11	-	-	GS05000	SS25	GS05003	QCT1100	QCT1101
S20S CTFP R/L 11	-	-	GS05000	SS25	GS05003	QCT1100	QCT1101
S16R CTFP R/L 16	-	-	GS06002	SS30	GS06003	QCT1600	QCT1601
S20S CTFP R/L 16	-	-	GS06002	SS30	GS06003	QCT1600	QCT1601
S25T CTFP R/L 16	-	-	GS06001	SS30	GS06003	QCT1600	QCT1601
S32U CTFP R/L 16	CT160301	BE02100	GS06000	SS30	GS06003	QCT1600	QCT1601
S40V CTFP R/L 16	CT160301	BE02100	GS06000	SS30	GS05005	QCT1600	QCT1601
S50W CTFP R/L 16	CT160301	BE02100	GS06000	SS30	GS05005	QCT1600	QCT1601
S40V CTFP R/L 22	CT220301	BE03000	GS08000	SS40	GS08001	QCT2200	QCT2201
S50W CTFP R/L 22	CT220301	BE03000	GS08000	SS40	GS08001	QCT2200	QCT2201

(C) TOP CLAMP TOOLHOLDERS

Medium to Finish	Finishing to Fine Finishing	Medium
Flat  (11-16-22)	12  (09-11-16)	13  (09-11-16-22)



Order Code		Reference	Dimensions (mm)							Insert	Kg	Stock	
R	L		D	H	h1	L1	L2	S	A			R	L
212245500	212332300	S10M CTUP R/L 09	10	9	4,5	150	25	7	13	TP.. 0902..	0,060		
212332400	212332500	S12M CTUP R/L 09	12	11	5,5	150	25	9	16	TP.. 0902..	0,150		
212332600	212332700	S12M CTUP R/L 11	12	11	5,5	150	25	9	16	TP.. 1103..	0,150		
212332800	212332900	S16R CTUP R/L 11	16	15	7,5	200	30	11	20	TP.. 1103..	0,300		
212333000	212333100	S20S CTUP R/L 11	20	18	9,0	250	35	13	24	TP.. 1103..	0,550		
212333200	212333300	S16R CTUP R/L 16	16	15	7,5	200	30	11	20	TP.. 1603..	0,300		
212333400	212333500	S20S CTUP R/L 16	20	18	9,0	250	35	13	24	TP.. 1603..	0,550		
212245600	212333600	S25T CTUP R/L 16	25	23	11,5	300	40	17	31	TP.. 1603..	0,700		
212333700	212333800	S32U CTUP R/L 16	32	30	15,0	350	50	22	39	TP.. 1603..	2,050		
212245700	212333900	S40V CTUP R/L 16	40	37	18,5	400	60	27	48	TP.. 1603..	3,750		
212334000	212334100	S50W CTUP R/L 16	50	47	23,5	450	65	35	61	TP.. 1603..	6,500		
212334200	212334300	S40V CTUP R/L 22	40	37	18,5	400	60	27	48	TP.. 2204..	3,750		
212334400	212334500	S50W CTUP R/L 22	50	47	23,5	450	65	35	61	TP.. 2204..	6,500		

 Stock Items | Itens de stock

 Available under request | Disponible sob consulta | Disponible bajo consulta







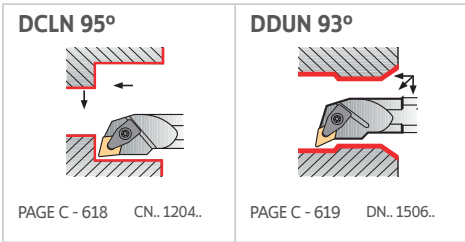
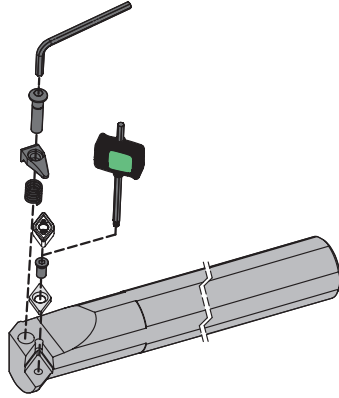



SPARE PARTS | Complementos | Repuestos

Cutter Reference	Complementary Accessories - Flat Inserts						
	Shim	Shim Pin	Clamp	Wrench	Clamp	Chip Breaker 1	Chip Breaker 2
S10M CTUP R/L 09	-	-	GS03000	SS15	-	-	-
S12M CTUP R/L 09	-	-	GS03000	SS15	-	-	-
S12M CTUP R/L 11	-	-	GS04000	SS25	-	-	-
S16R CTUP R/L 11	-	-	GS05000	SS25	GS05003	QCT1100	QCT1101
S20S CTUP R/L 11	-	-	GS05000	SS25	GS05003	QCT1100	QCT1101
S16R CTUP R/L 16	-	-	GS06002	SS30	GS06003	QCT1600	QCT1601
S20S CTUP R/L 16	-	-	GS06002	SS30	GS06003	QCT1600	QCT1601
S25T CTUP R/L 16	-	-	GS06001	SS30	GS06003	QCT1600	QCT1601
S32U CTUP R/L 16	CT160301	BE02100	GS06000	SS30	GS06003	QCT1600	QCT1601
S40V CTUP R/L 16	CT160301	BE02100	GS06000	SS30	GS05005	QCT1600	QCT1601
S50W CTUP R/L 16	CT160301	BE02100	GS06000	SS30	GS05005	QCT1600	QCT1601
S40V CTUP R/L 22	CT220301	BE03000	GS08000	SS40	GS08001	QCT2200	QCT2201
S50W CTUP R/L 22	CT220301	BE03000	GS08000	SS40	GS08001	QCT2200	QCT2201

(D) DIMPLE LOCK SYSTEM







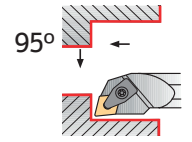

(D) DIMPLE LOCK TOOLHOLDERS

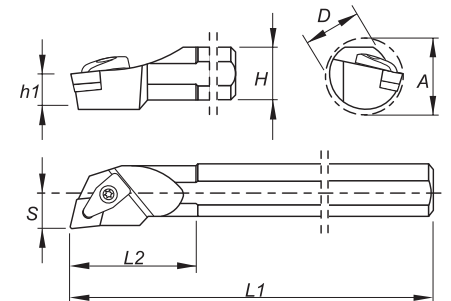
Roughing	Finishing	Medium to Finishing	Medium to Finishing	Medium	Medium
Flat  (12)	MF  (12)	SF  (12)	LC  (12)	MS  (12)	MR  (12)
Medium	Medium	Medium Wiper	Roughing to Medium	Roughing	
PM  (12)	ST  (12)	MW  (12)	SS  (12)	HR  (12)	



Axial: -5°
Radial: -13,5°









Order Code		Reference	Dimensions (mm)							Insert	Kg	Stock	
R	L		D	H	h1	L1	L2	S	A			R	L
212334600	212334700	S25T DCLN R/L 12	25	23	11,5	300	40	17	31	CN.. 1204..	0,700		
212334800	212334900	S32U DCLN R/L 12	32	30	15,0	350	50	22	39	CN.. 1204..	2,050		
212335000	212335100	S40V DCLN R/L 12	40	37	18,5	400	60	27	48	CN.. 1204..	3,750		









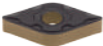

 Stock Items | Itens de stock

 Available under request | Disponível sob consulta | Disponible bajo consulta

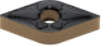
SPARE PARTS || Complementos | Repuestos

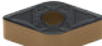
Cutter Reference	Shim	Shim Screw	Spring	Clamp	Clamp Screw	Wrench
S25T DCLN R/L 12						
S32U DCLN R/L 12	CC120300	T06010000	M09513	GA07002	D0602900	SS40
S40V DCLN R/L 12	CC120300	T06010000	M09513	GA07002	D0602900	SS40

(D) DIMPLE LOCK TOOLHOLDERS

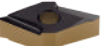
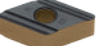
Roughing	Finishing	Medium to Finishing	Medium to Finishing	Medium	Medium	Medium	Medium
Flat	MF	SF	LC	MS	MR	PM	ST
							
(15)	(15)	(15)	(15)	(15)	(15)	(15)	(15)
Medium Wiper	Roughing to Medium	Roughing	Roughing	Roughing to Medium	Medium to Finishing	Medium to Finishing	
MW	SS	HR	RP	O1	O2	O3	
							
(15)	(15)	(15)	(15)	(15)	(15)	(15)	

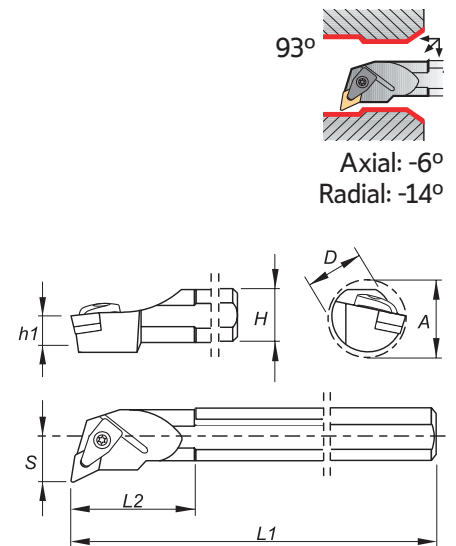







Order Code		Reference	Dimensions (mm)							Insert	Kg	Stock	
R	L		D	H	h1	L1	L2	S	A			R	L
212335200	212335300	S32U DDUN R/L 15	32	30	15,0	350	50	22	39	DN.. 1506..	2,050	○	○
212335400	212335500	S40V DDUN R/L 15	40	37	18,5	400	60	27	48	DN.. 1506..	3,750	○	○

⊗ Stock Items | Itens de stock

○ Available under request | Disponível sob consulta | Disponible bajo consulta

SPARE PARTS | Complementos | Repuestos

Cutter Reference	Shim	Shim Screw	Spring	Clamp	Clamp Screw	Wrench
S32U DDUN R/L 15						
S40V DDUN R/L 15	CD150501	T06010000	M09513	GA07002	D0602900	SS40
	CD150501	T06010000	M09513	GA07002	D0602900	SS40

C
TURNING
Insert selection
Overview
Negative inserts
Positive inserts
PCBN & PCD inserts
Heavy turning
External Toolholders
Internal Toolholders
Automatic Lathes
Spare Parts
Technical Data





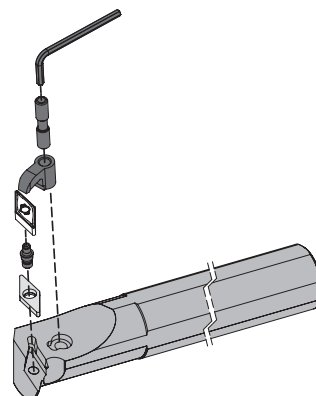
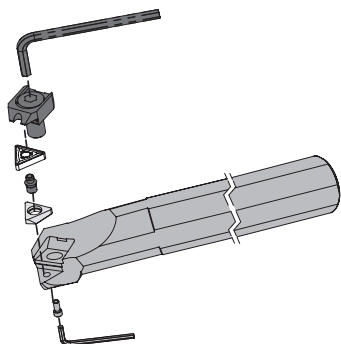

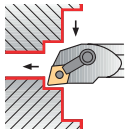
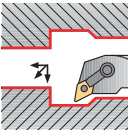
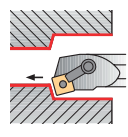
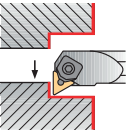
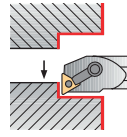
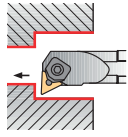
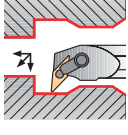
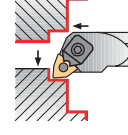
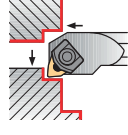



(M) WEDGE CLAMP SYSTEM

(M-K) DOUBLE LOCK SYSTEM







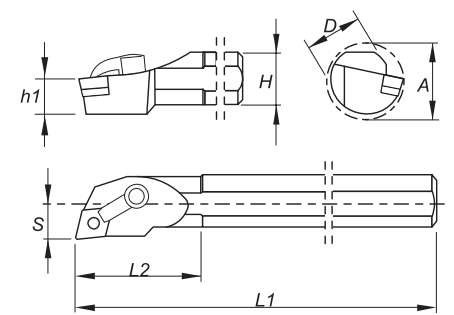
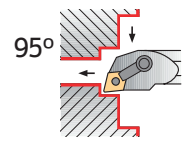

	<p>MCLN-K 95°</p>  <p>PAGE C - 621 CN.. 1204..</p>	<p>MDUN-K 93°</p>  <p>PAGE C - 622 DN.. 1506..</p>	<p>MSKN-K 75°</p>  <p>PAGE C - 623 SN.. 1204..</p>	<p>MTFN 90°</p>  <p>PAGE C - 624 TN.. 1604.. TN.. 2204..</p>	<p>MTFN-K 90°</p>  <p>PAGE C - 625 TN.. 1604..</p>	<p>MTUN 93°</p>  <p>PAGE C - 626 TN.. 1604.. TN.. 2204..</p>
	<p>MVUN-K 93°</p>  <p>PAGE C - 627 VN.. 1604..</p>	<p>MWLN 95°</p>  <p>PAGE C - 628 WN.. 0604.. WN.. 0804..</p>	<p>MWLN-K 95°</p>  <p>PAGE C - 629 WN.. 0804..</p>			

(M-K) DOUBLE LOCK TOOLHOLDERS

Roughing	Finishing	Medium to Finishing	Medium to Finishing	Medium	Medium
Flat  (12)	MF  (12)	SF  (12)	LC  (12)	MS  (12)	MR  (12)
Medium	Medium	Medium Wiper	Roughing to Medium	Roughing	
PM  (12)	ST  (12)	MW  (12)	SS  (12)	HR  (12)	



Order Code		Reference	Dimensions (mm)							Insert	Kg	Stock	
R	L		D	H	h1	L1	L2	S	A			R	L
212335600	212335700	S25T MCLN R/L 12-K	25	23	11,5	300	33	17	31	CN.. 1204..	0,700		
212335800	212335900	S32U MCLN R/L 12-K	32	30	15,0	350	50	22	39	CN.. 1204..	2,050		
212336000	212336100	S40V MCLN R/L 12-K	40	37	18,5	400	60	27	48	CN.. 1204..	3,750		

 Stock Items | Itens de stock

 Available under request | Disponível sob consulta | Disponible bajo consulta







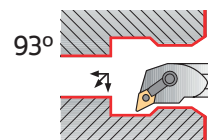







SPARE PARTS || Complementos | Repuestos

Cutter Reference	Shim	Lock Pin	Lock Pin Punch	Clamp	Differential Screw	Clamp Wrench
S25T MCLN R/L 12-K	-	BS1-402	SS25	GA06000	F0602100	SS30
S32U MCLN R/L 12-K	CC120500	BS1-400	SS25	GA06000	F0602900	SS30
S40V MCLN R/L 12-K	CC120500	BS1-400	SS25	GA06000	F0602900	SS30

(M-K) DOUBLE LOCK TOOLHOLDERS



Axial: -6°
Radial: -12°

Finishing	Medium to Finishing	Medium to Finishing	Medium	Medium	Medium	Medium
MF	SF	LC	MS	MR	PM	ST
						
(15)	(15)	(15)	(15)	(15)	(15)	(15)
Medium Wiper	Roughing to Medium	Roughing	Roughing	Roughing to Medium	Medium to Finishing	Medium to Finishing
MW	SS	HR	RP	O1	O2	O3
						
(15)	(15)	(15)	(15)	(15)	(15)	(15)

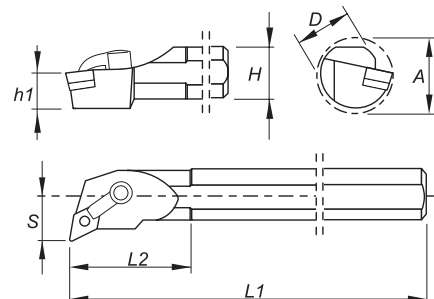

Order Code		Reference	Dimensions (mm)							Insert	Kg	Stock	
R	L		D	H	h1	L1	L2	S	A			R	L
212245300	212336200	S25T MDUN R/L 15-K	25	23	11,5	300	40	17	31	DN.. 1506..	0,700	⊗	⊗
212336300	212336400	S32U MDUN R/L 15-K	32	30	15,0	350	50	22	39	DN.. 1506..	2,050	○	○
212245400	212336500	S40V MDUN R/L 15-K	40	37	18,5	400	60	27	48	DN.. 1506..	3,750	○	○









⊗ Stock Items | Itens de stock

○ Available under request | Disponível sob consulta | Disponible bajo consulta

SPARE PARTS || Complementos | Repuestos

Cutter Reference	Shim	Lock Pin	Lock Pin Punch	Clamp	Differential Screw	Clamp Wrench
S25T MDUN R/L 15-K	-	BS1-402	SS25	GA06001	F0602100	SS30
S32U MDUN R/L 15-K	CD150501	BS1-401	SS25	GA06001	F0602900	SS30
S40V MDUN R/L 15-K	CD150501	BS1-401	SS25	GA06001	F0602900	SS30

(M-K) DOUBLE LOCK TOOLHOLDERS

Roughing	Finishing	Medium	Medium
Flat  (12)	MF  (12)	SF  (12)	MR  (12)
Medium	Medium	Roughing to Medium	Roughing
PM  (12)	ST  (12)	SS  (12)	HR  (12)

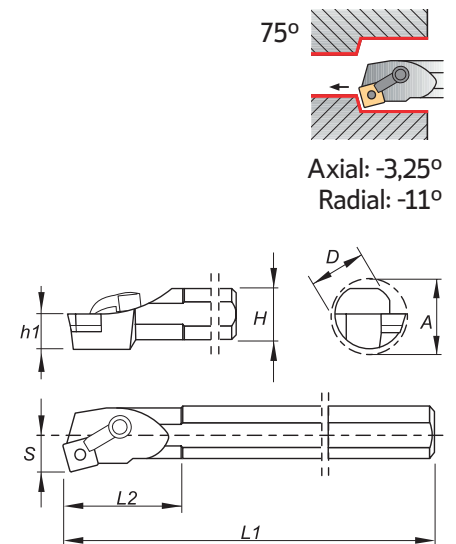













Order Code		Reference	Dimensions (mm)							Insert	Kg	Stock	
R	L		D	H	h1	L1	L2	S	A			R	L
212336600	212336700	S32U MSKN R/L 12-K	32	30	15,0	350	50	22	39	SN.. 1204..	2,050	○	○
212336800	212336900	S40V MSKN R/L 12-K	40	37	18,5	400	60	27	48	SN.. 1204..	3,750	○	○











⊗ Stock Items | Itens de stock

○ Available under request | Disponível sob consulta | Disponible bajo consulta









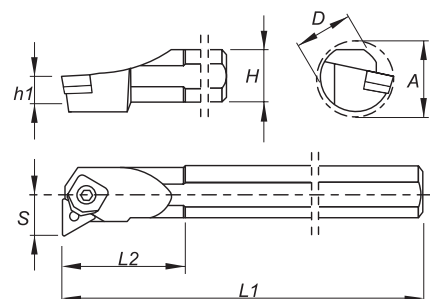
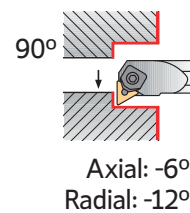







SPARE PARTS || Complementos | Repuestos

Cutter Reference	Shim	Lock Pin	Lock Pin Punch	Clamp	Differential Screw	Clamp Wrench
S32U MSKN R/L 12-K	 CS120500	 BS1-400	 SS25	 GA06000	 F0602900	 SS30
S40V MSKN R/L 12-K	 CS120500	 BS1-400	 SS25	 GA06000	 F0602900	 SS30

(M-K) DOUBLE LOCK TOOLHOLDERS

Roughing	Finishing	Medium to Finishing	Medium to Finishing	Medium	Medium
Flat	MF	SF	LC	MS	MR
 (16-22)	 (16-22)	 (16-22)	 (16-22)	 (16)	 (16-22)
Medium	Medium	Roughing to Medium	Roughing	Medium to Finishing	
PM	ST	SS	HR	O1	
 (16-22)	 (16-22)	 (16-22)	 (16-22)	 (16)	







Order Code		Reference	Dimensions (mm)							Insert	Kg	Stock	
R	L		D	H	h1	L1	L2	S	A			R	L
212050300	212338100	S25T MTFN R/L 16	25	23	11,5	300	40	17	34	TN.. 1604..	0,700		
212168200	212338200	S32U MTFN R/L 16	32	30	15,0	350	50	22	39	TN.. 1604..	2,050		
212338300	212338400	S40V MTFN R/L 16	40	37	18,5	400	60	27	48	TN.. 1604..	3,750		
212338500	212338600	S50W MTFN R/L 16	50	47	23,5	450	65	35	61	TN.. 1604..	6,500		
212421000	212421100	S60Y MTFN R/L 16	60	57	28,5	600	75	43	80	TN.. 1604..	12,600		
212338700	212338800	S40V MTFN R/L 22	40	37	18,5	400	60	27	48	TN.. 2204..	3,750		
212017500	212338900	S50W MTFN R/L 22	50	47	23,5	450	65	35	61	TN.. 2204..	6,500		
212421800	212421900	S60Y MTFN R/L 22	60	57	28,5	600	75	43	80	TN.. 2204..	12,600		











 Stock Items | Itens de stock

 Available under request | Disponível sob consulta | Disponible bajo consulta





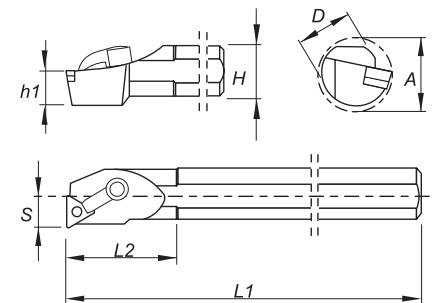
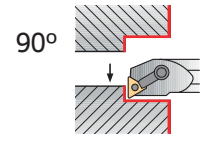

SPARE PARTS || Complementos | Repuestos

Cutter Reference	Shim	Lock Pin	Lock Pin Punch	Wedge Clamp	Wrench
S25T MTFN R/L 16					
S32U MTFN R/L 16	CT160302	BC04501	D0300691	GW08001	SS50
S40V MTFN R/L 16	CT160302	BC04501	D0300700	GW08001	SS50
S50W MTFN R/L 16	CT160302	BC04501	D0300700	GW08001	SS50
S60Y MTFN R/L 16	CT160302	BC04501	D0300691	GW08001	SS50
S40V MTFN R/L 22	CT220500	BC06000	D0400900	GW08003	SS50
S50W MTFN R/L 22	CT220500	BC06000	D0400900	GW08003	SS50
S60Y MTFN R/L 22	CT220500	BC06000	D0400900	GW08003	SS50

(M-K) DOUBLE LOCK TOOLHOLDERS

Roughing	Finishing	Medium to Finishing	Medium to Finishing	Medium	Medium
Flat	MF	SF	LC	MS	MR
 (16-22)	 (16-22)	 (16-22)	 (16-22)	 (16)	 (16-22)
Medium	Medium	Roughing to Medium	Roughing	Medium to Finishing	
PM	ST	SS	HR	O1	
 (16-22)	 (16-22)	 (16-22)	 (16-22)	 (16)	









Order Code		Reference	Dimensions (mm)							Insert	Kg	Stock	
R	L		D	H	h1	L1	L2	S	A			R	L
212337000	212337100	S25T MTFN R/L 16-K	25	23	11,5	300	40	17	31	TN.. 1604..	0,700		
212337200	212337300	S32U MTFN R/L 16-K	32	30	15,0	350	50	22	39	TN.. 1604..	2,050		
212337400	212337500	S40V MTFN R/L 16-K	40	37	18,5	400	60	27	48	TN.. 1604..	3,750		













 Stock Items | Itens de stock

 Available under request | Disponible sob consulta | Disponibile bajo consulta

SPARE PARTS || Complementos | Repuestos

Cutter Reference	Shim	Lock Pin	Lock Pin Wrench	Clamp	Differential Screw	Clamp Wrench
S25T MTFN R/L 16-K						
S32U MTFN R/L 16-K	CT160304	BS05000	SS20	GA06000	F0602900	SS30
S40V MTFN R/L 16-K	CT160304	BS05000	SS20	GA06000	F0602900	SS30





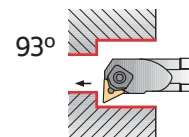



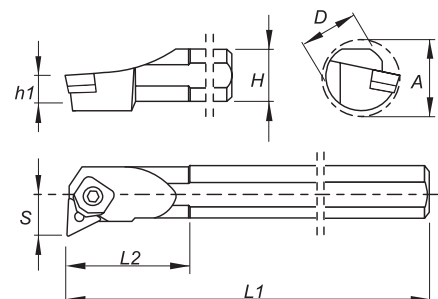



(M) WEDGE CLAMP TOOLHOLDERS

Roughing	Finishing	Medium to Finishing	Medium to Finishing	Medium	Medium
Flat	MF	SF	LC	MS	MR
 (16-22)	 (16-22)	 (16-22)	 (16-22)	 (16)	 (16-22)
Medium	Medium	Medium wiper	Roughing to Medium	Roughing	Medium to Finishing
PM	ST	MW	SS	HR	O1
 (16-22)	 (16-22)	 (16-22)	 (16-22)	 (16-22)	 (16)



Axial: -6°
Radial: -11°







Order Code		Reference	Dimensions (mm)							Insert	Kg	Stock	
R	L		D	H	h1	L1	L2	S	A			R	L
212339000	212339100	S25T MTUN R/L 16	25	23	11,5	300	40	17	34	TN.. 1604..	0,700		
212339200	212339300	S32U MTUN R/L 16	32	30	15,0	350	50	22	39	TN.. 1604..	2,050		
212339400	212339500	S40V MTUN R/L 16	40	37	18,5	400	60	27	48	TN.. 1604..	3,750		
212339600	212339700	S50W MTUN R/L 16	50	47	23,5	450	65	35	61	TN.. 1604..	6,500		
212339800	212339900	S40V MTUN R/L 22	40	37	18,5	400	60	27	48	TN.. 2204..	3,750		
212340000	212340100	S50W MTUN R/L 22	50	47	23,5	450	65	35	61	TN.. 2204..	6,500		









 Stock Items | Itens de stock

 Available under request | Disponível sob consulta | Disponible bajo consulta

SPARE PARTS | Complementos | Repuestos

Cutter Reference	Shim	Lock Pin	Lock Pin Punch	Wedge Clamp	Wrench
S25T MTUN R/L 16	 CT160302	 BC04501	 D0300691	 GW08001	 SS50
S32U MTUN R/L 16	CT160302	BC04501	D0300700	GW08001	SS50
S40V MTUN R/L 16	CT160302	BC04501	D0300700	GW08001	SS50
S50W MTUN R/L 16	CT160302	BC04501	D0300700	GW08001	SS50
S40V MTUN R/L 22	CT220500	BC06000	D0400900	GW08003	SS50
S50W MTUN R/L 22	CT220500	BC06000	D0400900	GW08003	SS50





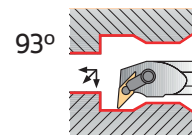

(M-K) DOUBLE LOCK TOOLHOLDERS

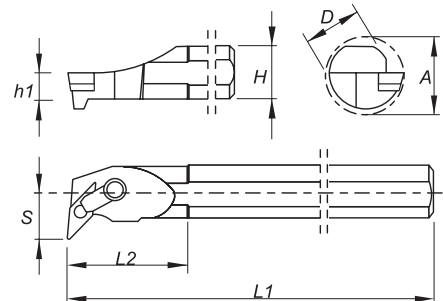
Roughing	Finishing	Medium to Finishing	Medium to Finishing	Medium to Finishing
Flat	MF	SF	LC	MS
 (16)	 (16)	 (16)	 (16)	 (16)
Medium	Medium	Medium	Roughing to Medium	
MR	PM	ST	SS	
 (16)	 (16)	 (16)	 (16)	



Axial: -5°
Radial: -15°

















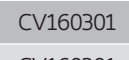



Order Code		Reference	Dimensions (mm)							Insert	Kg	Stock	
R	L		D	H	h1	L1	L2	S	A			R	L
212050400	212337600	S25T MVUN R/L 16-K	25	23	11,5	300	40	17	31	VN.. 1604..	0,700		
212337700	212337800	S32U MVUN R/L 16-K	32	30	15,0	350	50	22	39	VN.. 1604..	2,050		
212337900	212338000	S40V MVUN R/L 16-K	40	37	18,5	400	60	27	48	VN.. 1604..	3,750		











 Stock Items | Itens de stock

 Available under request | Disponível sob consulta | Disponible bajo consulta

SPARE PARTS || Complementos | Repuestos

Cutter Reference	Shim	Lock Pin	Lock Pin Wrench	Clamp	Differential Screw	Clamp Wrench
S25T MVUN R/L 16-K	 CV160301	 BS05000	 SS20	 GA06001	 F0602100	 SS30
S32U MVUN R/L 16-K	 CV160301	 BS05000	 SS20	 GA06001	 F0602900	 SS30
S40V MVUN R/L 16-K	 CV160301	 BS05000	 SS20	 GA06001	 F0602900	 SS30





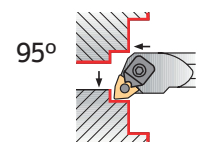



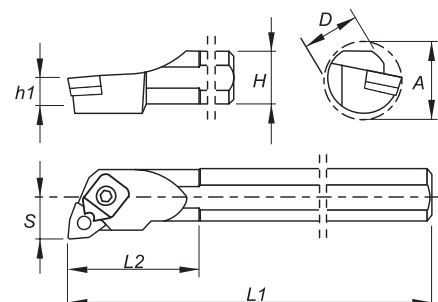







(M) WEDGE CLAMP TOOLHOLDERS

Roughing	Finishing	Medium to Finishing	Medium to Finishing	Medium	Medium
Flat  (08)	MF  (06-08)	SF  (06-08)	LC  (08)	MS  (06-08)	PM  (08)
Medium	Medium	Medium Wiper	Roughing to Medium	Roughing	
MR  (06-08)	ST  (08)	MW  (06-08)	SS  (06-08)	HR  (08)	



Axial: -5°
Radial: -11,5°







Order Code		Reference	Dimensions (mm)							Insert	Kg	Stock	
R	L		D	H	h1	L1	L2	S	A			R	L
212050500	212340200	S20S MWLN R/L 06	20	18	9,0	250	36	13	27	WN.. 0604..	0,550		
212340300	212340400	S25T MWLN R/L 06	25	23	11,5	300	40	17	31	WN.. 0604..	0,700		
212340500	212340600	S32U MWLN R/L 06	32	30	15,0	350	50	22	39	WN.. 0604..	2,050		
212054400	212340700	S25T MWLN R/L 08	25	23	11,5	300	40	17	31	WN.. 0804..	0,700		
212044100	212044000	S32U MWLN R/L 08	32	30	15,0	350	50	22	39	WN.. 0804..	2,050		
212340800	212340900	S40V MWLN R/L 08	40	37	18,5	400	60	27	48	WN.. 0804..	3,750		
212341000	212341100	S50W MWLN R/L 08	50	47	23,5	450	65	35	61	WN.. 0804..	6,500		
212421200	212421300	S60Y MWLN R/L 08	60	57	28,5	600	75	43	80	WNM. 0804..	12,600		











 Stock Items | Itens de stock

 Available under request | Disponível sob consulta | Disponible bajo consulta

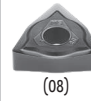





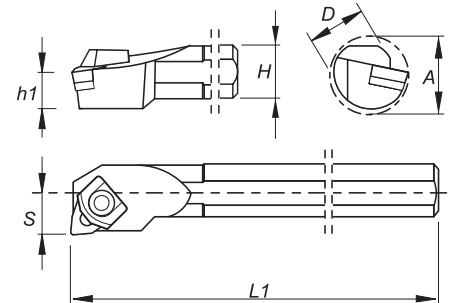
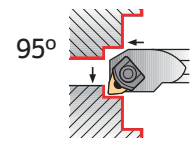

SPARE PARTS | Complementos | Repuestos

Cutter Reference	Shim 	Lock Pin 	Lock Pin Punch 	Wedge Clamp 	Wrench 
S20S MWLN R/L 06	-	BC04502	D0300691	GW05000	SS25
S25T MWLN R/L 06	CW060300	BC04501	D0300691	GW05000	SS25
S32U MWLN R/L 06	CW060300	BC04501	D0300691	GW05000	SS25
S25T MWLN R/L 08	-	BC06001	D0400691	GW08000	SS25
S32U MWLN R/L 08	CW080500	BC06000	D0400691	GW08000	SS25
S40V MWLN R/L 08	CW080500	BC06000	D0400691	GW08000	SS25
S50W MWLN R/L 08	CW080500	BC06000	D0400691	GW08000	SS25
S60Y MWLN R/L 08	CW080500	BC06000	D0400691	GW08000	SS25

(M-K) DOUBLE LOCK TOOLHOLDERS

Roughing	Finishing	Medium to Finishing	Medium to Finishing	Medium	Medium
Flat	MF	SF	LC	MS	PM
 (08)	 (08)	 (08)	 (08)	 (08)	 (08)
Medium	Medium	Medium Wiper	Roughing to Medium	Roughing	
MR	ST	MW	SS	HR	
 (08)	 (08)	 (08)	 (08)	 (08)	







Order Code		Reference	Dimensions (mm)							Insert	Kg	Stock	
R	L		D	H	h1	L1	L2	S	A			R	L
212341200	212341300	S25T MWLN R/L 08-K	25	23	11,5	300	40	17	31	WN.. 0804..	0,700		
212341400	212341500	S32U MWLN R/L 08-K	32	30	15,0	350	50	22	39	WN.. 0804..	2,050		
212341600	212341700	S40V MWLN R/L 08-K	40	37	18,5	400	60	27	48	WN.. 0804..	3,750		
212341800	212341900	S50W MWLN R/L 08-K	50	47	23,5	450	65	35	61	WN.. 0804..	6,500		

 Stock Items | Itens de stock

 Available under request | Disponível sob consulta | Disponible bajo consulta

SPARE PARTS || Complementos | Repuestos





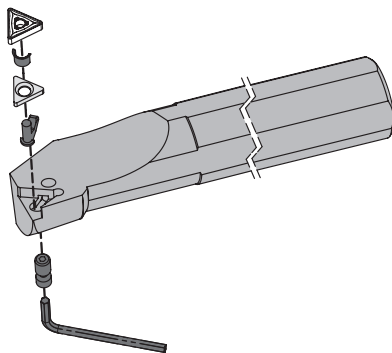

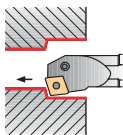
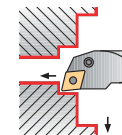
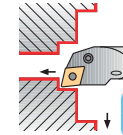
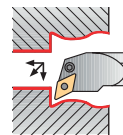
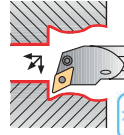
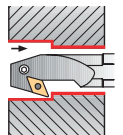
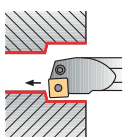
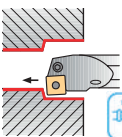
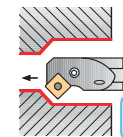
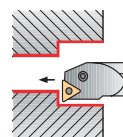
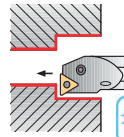
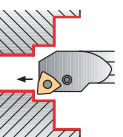
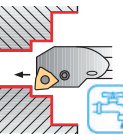







Cutter Reference	Shim	Lock Pin	Lock Pin Screw	Wedge Clamp	Wrench
S25T MWLN R/L 08-K	-				
S32U MWLN R/L 08-K	CW080500	BC06001	D0400691	GW06000	SS25
S40V MWLN R/L 08-K	CW080500	BC06000	D0400691	GW06000	SS25
S50W MWLN R/L 08-K	CW080500	BC06000	D0400691	GW06000	SS25

(P) LEVER LOCK SYSTEM



<p>PCKN 75°</p>  <p>PAGE C - 631 CN.. 1204.. CN.. 1606.. CN.. 1906..</p>	<p>PCLN 95°</p>  <p>PAGE C - 632 CN.. 0903.. ... CN.. 1906..</p>	<p>A-PCLN 95°</p>  <p>PAGE C - 633 CN.. 0903.. ... CN.. 1204..</p>	<p>PDUN 93°</p>  <p>PAGE C - 634 DN.. 1104.. DN.. 1506..</p>	<p>A-PDUN 93°</p>  <p>PAGE C - 635 DN.. 1104.. DN.. 1506..</p>	<p>PDUN 93° - BT</p>  <p>PAGE C - 636 DN.. 1506..</p>
<p>PSKN 75°</p>  <p>PAGE C - 637 SN.. 1204.. SN.. 1906..</p>	<p>A-PSKN 75°</p>  <p>PAGE C - 638 SN.. 1204..</p>	<p>A-PSSN 45°</p>  <p>PAGE C - 639 SN.. 1204..</p>	<p>PTFN 90°</p>  <p>PAGE C - 640 TN.. 1604.. TN.. 2204..</p>	<p>A-PTFN 90°</p>  <p>PAGE C - 641 TN.. 1604.. TN.. 2204..</p>	<p>PWLN 95°</p>  <p>PAGE C - 642 WN.. 0604.. WN.. 0804..</p>
<p>A-PWLN 95°</p>  <p>PAGE C - 643 WN.. 0604.. WN.. 0804..</p>					

(P) LEVER LOCK TOOLHOLDERS

Roughing	Finishing	Medium to Finishing	Medium to Finishing	Medium	Medium	Medium
Flat  (12-16-19)	MF  (12)	SF  (12)	LC  (12)	MS  (12)	MR  (12-16-19)	PM  (12)
Medium	Medium Wiper	Roughing to Medium	Roughing	Roughing	Heavy to Roughing	Heavy to Roughing
ST  (12-19)	MW  (12)	SS  (12-16-19)	HR  (12-16-19)	RP  (19)	HY  (19)	HZ  (19)

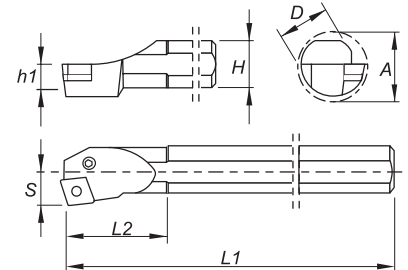
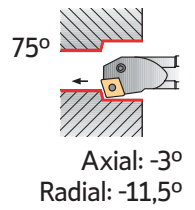

Order Code		Reference	Dimensions (mm)							Insert	Kg	Stock	
R	L		D	H	h1	L1	L2	S	A			R	L
212342000	212342100	S25T PCKN R/L 12	25	23	11,5	300	40	17	31	CN.. 1204..	0,700	⊗	⊗
212342200	212342300	S32U PCKN R/L 12	32	30	15,0	350	50	22	39	CN.. 1204..	2,050	○	○
212342400	212342500	S40V PCKN R/L 12	40	37	18,5	400	60	27	48	CN.. 1204..	3,750	○	○
212421400	212421500	S50W PCKN R/L 12	50	47	23,5	450	60	35	61	CN.. 1204..	6,500	○	○
212421600	212421700	S60Y PCKN R/L 12	60	57	28,5	600	75	43	80	CN.. 1204..	12,600	○	○
212342600	212342700	S50W PCKN R/L 16	50	47	23,5	450	65	35	61	CN.. 1606..	6,500	○	○
212422000	212422100	S60Y PCKN R/L 16	60	57	28,5	600	75	43	80	CN.. 1606..	12,600	○	○
212342800	212342900	S50W PCKN R/L 19	50	47	23,5	450	65	35	61	CN.. 1906..	6,500	○	○
212422200	212422300	S60Y PCKN R/L 19	60	57	28,5	600	75	43	80	CN.. 1906..	12,600	○	○

⊗ Stock Items | Itens de stock

○ Available under request | Disponível sob consulta | Disponible bajo consulta

SPARE PARTS | Complementos | Repuestos

Cutter Reference	Order separately					
	Shim	Shim Pin	Shim Pin Punch	Lever	Lever Screw	Wrench
S25T PCKN R/L 12	-	-	-	AN12100	PA0601300	SS25
S32U PCKN R/L 12	CC120301	BE05500	BF47509	AC13200	PA0801700	SS30
S40V PCKN R/L 12	CC120301	BE05500	BF47509	AN13100	PA0802100	SS30
S50W PCKN R/L 12	CC120301	BE05500	BF47509	AN13100	PA0802100	SS30
S60Y PCKN R/L 12	CC120301	BE05500	BF47509	AN13100	PA0802100	SS30
S50W PCKN R/L 16	CC160500	BE07000	BF65012	AN17100	PA0802300	SS30
S60Y PCKN R/L 16	CC160500	BE07000	BF65012	AN17100	PA0802300	SS30
S50W PCKN R/L 19	CC190500	BE08500	BF80012	AN20800	PA1002700	SS40
S60Y PCKN R/L 19	CC190500	BE08500	BF0012	AN20800	PA1002700	SS40

C TURNING Insert selection Overview Negative inserts Positive inserts PCBN & PCD inserts Heavy turning External Toolholders Internal Toolholders Automatic Lathes Spare Parts Technical Data

(P) LEVER LOCK TOOLHOLDERS

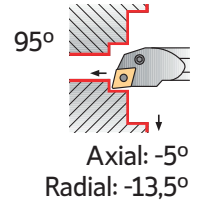

Roughing	Finishing	Medium to Finishing	Medium to Finishing	Medium	Medium	Medium
Flat	MF	SF	LC	MS	MR	PM
(09-12-16-19)	(09-12)	(12)	(12)	(12)	(09-12-16-19)	(12)
Medium	Medium Wiper	Roughing to Medium	Roughing	Roughing	Heavy to Roughing	Heavy to Roughing
ST	MW	SS	HR	RP	HY	HZ
(09-12-16-19)	(12)	(09-12-16-19)	(12-16-19)	(19)	(19)	(19)

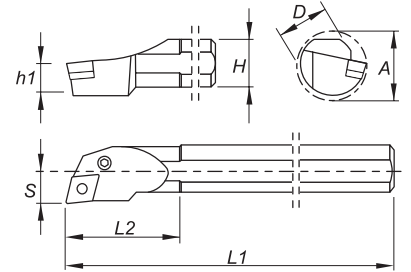

Order Code		Reference	Dimensions (mm)							Insert	Kg	Stock	
R	L		D	H	h1	L1	L2	S	A			R	L
212247000	212343000	S16R PCLN R/L 09	16	15	7,5	200	26	11	20	CN.. 0903..	0,300	⊗	⊗
212050600	212343100	S20S PCLN R/L 09	20	18	9,0	250	29	13	25	CN.. 0903..	0,550	⊗	⊗
212247100	212343200	S25T PCLN R/L 09	25	23	11,5	300	33	17	32	CN.. 0903..	0,700	⊗	⊗
212048400	212343300	S25T PCLN R/L 12	25	23	11,5	300	40	17	31	CN.. 1204..	0,700	⊗	⊗
212169900	212343400	S32U PCLN R/L 12	32	30	15,0	350	50	22	39	CN.. 1204..	2,050	○	○
212247200	212017300	S40V PCLN R/L 12	40	37	18,5	400	60	27	48	CN.. 1204..	3,750	○	○
212343500	212343600	S50W PCLN R/L 12	50	47	23,5	450	65	35	61	CN.. 1204..	6,500	○	○
212423300	212423400	S60Y PCLN R/L 12	60	57	28,5	600	75	43	80	CN.. 1204..	12,600	○	○
212423500	212423600	S40V PCLN R/L 16	40	37	18,5	400	50	27	48	CN.. 1606..	3,750	○	○
212017700	212343700	S50W PCLN R/L 16	50	47	23,5	450	65	35	61	CN.. 1606..	6,500	○	○
212423700	212423800	S60Y PCLN R/L 16	60	57	28,5	600	75	43	80	CN.. 1606..	12,600	○	○
212017800	212017600	S50W PCLN R/L 19	50	47	23,5	450	65	35	61	CN.. 1906..	6,500	○	○
212423900	212424000	S60Y PCLN R/L 19	60	57	28,5	600	75	43	80	CN.. 1906..	12,600	○	○











⊗ Stock Items | Itens de stock

○ Available under request | Disponível sob consulta | Disponible bajo consulta









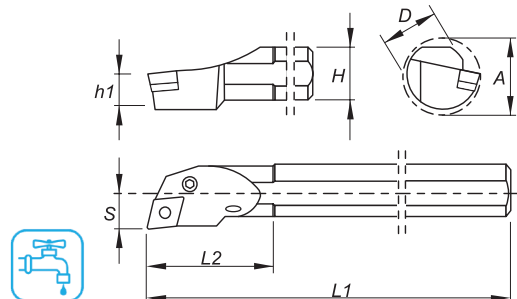
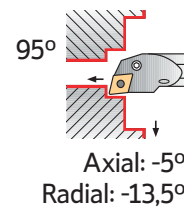

SPARE PARTS | Complementos | Repuestos

Cutter Reference	Order separately					
	Shim	Shim Pin	Shim Pin Punch	Lever	Lever Screw	Wrench
S16R PCLN R/L 09	-	-	-	AN07800	PA0501200	SS20
S20S PCLN R/L 09	-	-	-	AN07800	PA0501200	SS20
S25T PCLN R/L 09	CC090300	BE04400	BF40009	AN01200	PA0601300	SS25
S25T PCLN R/L 12	-	-	-	AN12100	PA0601300	SS25
S32U PCLN R/L 12	CC120301	BE05500	BF47509	AC13200	PA0801700	SS30
S40V PCLN R/L 12	CC120301	BE05500	BF47509	AN13100	PA0802100	SS30
S50W PCLN R/L 12	CC120301	BE05500	BF47509	AN13100	PA0802100	SS30
S60Y PCLN R/L 12	CC120301	BE05500	BF47509	AN13100	PA0802100	SS30
S40V PCLN R/L 16	CC160500	BE07000	BF65012	AN17100	PA0802300	SS30
S50W PCLN R/L 16	CC160500	BE07000	BF65012	AN17100	PA0802300	SS30
S60Y PCLN R/L 16	CC160500	BE07000	BF65012	AN17100	PA0802300	SS30
S50W PCLN R/L 19	CC190500	BE08300	BF80012	AN20200	PA1002700	SS40
S60Y PCLN R/L 19	CC190500	BE08300	BF80012	AN20200	PA1002700	SS40

(P) LEVER LOCK TOOLHOLDERS

Roughing	Finishing	Medium to Finishing	Medium to Finishing	Medium	Medium
Flat  (09-12)	MF  (09-12)	SF  (12)	LC  (12)	MS  (12)	MR  (09-12)
Medium	Medium	Medium Wiper	Roughing to Medium	Roughing	
PM  (12)	ST  (09-12)	MW  (12)	SS  (09-12)	HR  (12)	









Order Code		Reference	Dimensions (mm)							Insert	Kg	Stock	
R	L		D	H	h1	L1	L2	S	A			R	L
212343800	212343900	A16M PCLN R/L 09	16	15	7,5	150	26	11	20	CN.. 0903..	0,200		
212344000	212344100	A20Q PCLN R/L 09	20	18	9,0	180	29	13	25	CN.. 0903..	0,400		
212344200	212344300	A25R PCLN R/L 12	25	23	11,5	200	40	17	31	CN.. 1204..	0,700		
212344400	212344500	A32S PCLN R/L 12	32	30	15,0	250	50	22	39	CN.. 1204..	1,400		
212344600	212344700	A40T PCLN R/L 12	40	37	18,5	300	60	27	48	CN.. 1204..	2,650		















 Stock Items | Itens de stock

 Available under request | Disponível sob consulta | Disponible bajo consulta

SPARE PARTS | Complementos | Repuestos

Cutter Reference	Order separately					
	Shim	Shim Pin	Shim Pin Punch	Lever	Lever Screw	Wrench
A16M PCLN R/L 09						
A20Q PCLN R/L 09	-	-	-	AN07800	PA0501200	SS20
A25R PCLN R/L 12	-	-	-	AN12100	PA0601300	SS25
A32S PCLN R/L 12	CC120301	BE05500	BF47509	AC13200	PA0801700	SS30
A40T PCLN R/L 12	CC120301	BE05500	BF47509	AN13100	PA0802100	SS30





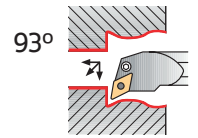



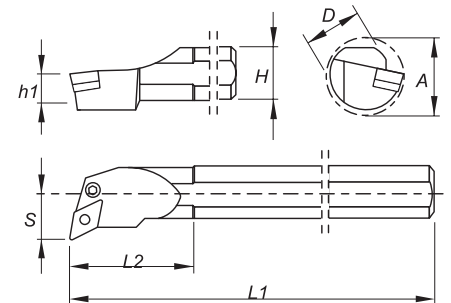

(P) LEVER LOCK TOOLHOLDERS

Roughing	Finishing	Medium to Finishing	Medium to Finishing	Medium	Medium	Medium	Medium
Flat	MF	SF	LC	MS	MR	PM	ST
 (11-15)	 (11-15)	 (11-15)	 (15)	 (15)	 (11-15)	 (15)	 (11-15)
Medium Wiper	Roughing to Medium	Roughing	Roughing	Roughing to Medium	Medium to Finishing	Medium to Finishing	
MW	SS	HR	RP	O1	O2	O3	
 (15)	 (11-15)	 (15)	 (15)	 (15)	 (15)	 (15)	



Axial: -6°
Radial: -14°

































Order Code		Reference	Dimensions (mm)							Insert	Kg	Stock	
R	L		D	H	h1	L1	L2	S	A			R	L
212079300	212344800	S25T PDUN R/L 11	25	23	11,5	300	35	17	32	DN.. 1104..	0,700		
212247300	212344900	S32U PDUN R/L 11	32	30	15,0	350	40	22	40	DN.. 1104..	2,050		
212079400	212079500	S32U PDUN R/L 15	32	30	15,0	350	50	22	39	DN.. 1506..	2,050		
212345000	212345100	S40V PDUN R/L 15	40	37	18,5	400	60	27	48	DN.. 1506..	3,750		
212018000	212017900	S50W PDUN R/L 15	50	47	23,5	450	65	35	61	DN.. 1506..	6,500		













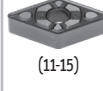

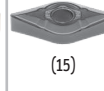
 Stock Items | Itens de stock

 Available under request | Disponível sob consulta | Disponible bajo consulta

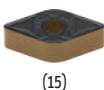

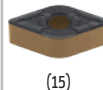

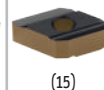

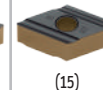
SPARE PARTS || Complementos | Repuestos

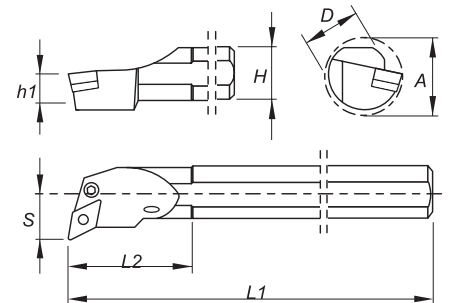
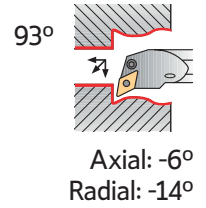
Cutter Reference	Order separately						for inserts DN.. 1504..	
	Shim	Shim Pin	Shim Pin Punch	Lever	Lever Screw	Wrench	Shim	Shim Pin
S25T PDUN R/L 11							-	-
S32U PDUN R/L 11							-	-
S32U PDUN R/L 15							CD150500	BE05401
S40V PDUN R/L 15							CD150500	BE05401
S50W PDUN R/L 15							CD150500	BE05401

(P) LEVER LOCK TOOLHOLDERS

Roughing	Finishing	Medium to Finishing	Medium to Finishing	Medium	Medium	Medium	Medium
Flat	MF	SF	LC	MS	MR	PM	ST
 (11-15)	 (11-15)	 (11-15)	 (15)	 (15)	 (11-15)	 (15)	 (11-15)
Medium Wiper	Roughing to Medium	Roughing	Roughing	Roughing to Medium	Medium to Finishing	Medium to Finishing	
MW	SS	HR	RP	O1	O2	O3	
 (15)	 (11-15)	 (15)	 (15)	 (15)	 (15)	 (15)	















Order Code		Reference	Dimensions (mm)							Insert	Kg	Stock	
R	L		D	H	h1	L1	L2	S	A			R	L
212345200	212345300	A25R PDUN R/L 11	25	23	11,5	200	40	17	31	DN.. 1104..	0,700		
212345400	212345500	A32S PDUN R/L 15	32	30	15,0	250	50	22	39	DN.. 1506..	1,400		
212345600	212345700	A40T PDUN R/L 15	40	37	18,5	300	60	27	48	DN.. 1506..	2,650		

 Stock Items | Itens de stock

 Available under request | Disponível sob consulta | Disponible bajo consulta

SPARE PARTS | Complementos | Repuestos







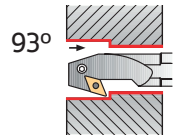

Cutter Reference	Order separately						for inserts DN.. 1504..	
	Shim	Shim Pin	Shim Pin Punch	Lever	Lever Screw	Wrench	Shim	Shim Pin
A25R PDUN R/L 11							-	-
A32S PDUN R/L 15							CD150500	BE05401
A40T PDUN R/L 15							CD150500	BE05401

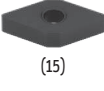
C
TURNING
Insert selection
Overview
Negative inserts
Positive inserts
PCBN & PCD inserts
Heavy turning
External Toolholders
Internal Toolholders
Automatic Lathes
Spare Parts
Technical Data

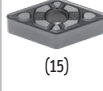
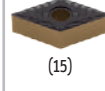
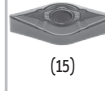
(P) LEVER LOCK TOOLHOLDERS

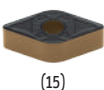
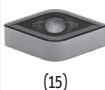
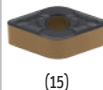

Axial: -6°
Radial: -14°

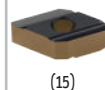
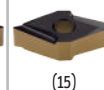
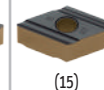
Roughing	Finishing	Medium to Finishing	Medium to Finishing	Medium	Medium	Medium	Medium
Flat	MF	SF	LC	MS	MR	PM	ST
 (15)	 (15)	 (15)	 (15)	 (15)	 (15)	 (15)	 (15)
Medium Wiper	Roughing to Medium	Roughing	Roughing	Roughing to Medium	Medium to Finishing	Medium to Finishing	
MW	SS	HR	RP	O1	O2	O3	
 (15)	 (15)	 (15)	 (15)	 (15)	 (15)	 (15)	

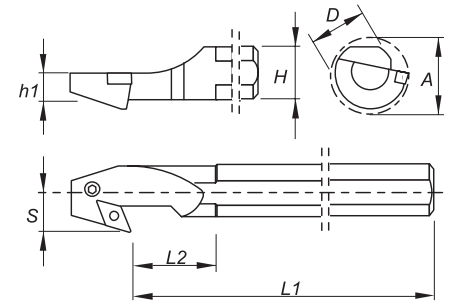

Order Code		Reference	Dimensions (mm)							Insert	Kg	Stock	
R	L		D	H	h1	L1	L2	S	A			R	L
212345800	212345900	S32U PDUN R/L 15-BT	32	30	15,0	350	50	22	39	DN.. 1506..	2,050	○	○
212346000	212346100	S40V PDUN R/L 15-BT	40	37	18,5	400	60	27	48	DN.. 1506..	3,750	○	○
212346200	212346300	S50W PDUN R/L 15-BT	50	47	23,5	450	65	35	61	DN.. 1506..	6,500	○	○











⊗ Stock Items | Itens de stock

○ Available under request | Disponível sob consulta | Disponible bajo consulta









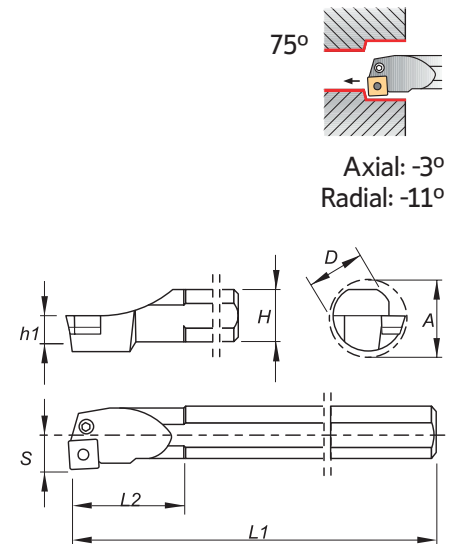





SPARE PARTS || Complementos | Repuestos

Cutter Reference	Order separately						for inserts DN.. 1504..	
	Shim	Shim Pin	Shim Pin Punch	Lever	Lever Screw	Wrench	Shim	Shim Pin
S32U PDUN R/L 15-BT	-	-	-	AN14700	PA0801700	SS30	-	-
S40V PDUN R/L 15-BT	CD150300	BE05500	BF47509	AN14700	PA0802101	SS30	CD150500	BE05401
S50W PDUN R/L 15-BT	CD150300	BE05500	BF47509	AN14700	PA0802101	SS30	CD150500	BE05401

(P) LEVER LOCK TOOLHOLDERS

Roughing	Finishing	Medium	Medium	Medium	Medium
Flat  (12-19)	MF  (12)	SF  (12)	MR  (12-19)	PM  (12)	ST  (12-19)
Roughing to Medium	Roughing	Roughing	Heavy to Roughing	Heavy to Roughing	
SS  (12-19)	HR  (12-19)	RP  (15-19)	HY  (19)	HZ  (19)	







Order Code		Reference	Dimensions (mm)							Insert	Kg	Stock	
R	L		D	H	h1	L1	L2	S	A			R	L
212050700	212346400	S25T PSKN R/L 12	25	23	11,5	300	40	17	31	SN.. 1204..	0,700		
212346500	212346600	S32U PSKN R/L 12	32	30	15,0	350	50	22	39	SN.. 1204..	2,050		
212346700	212346800	S40V PSKN R/L 12	40	37	18,5	400	60	27	48	SN.. 1204..	3,750		
212424100	212424200	S40V PSKN R/L 15	40	37	18,5	400	50	27	48	SN.. 1506..	3,750		
212424300	212424400	S50W PSKN R/L 15	50	47	23,5	450	60	35	61	SN.. 1506..	6,500		
212346900	212347000	S50W PSKN R/L 19	50	47	23,5	450	65	35	61	SN.. 1906..	6,500		
212424500	212424600	S60Y PSKN R/L 19	60	57	28,5	600	75	43	80	SN.. 1906..	12,600		

 Stock Items | Itens de stock









 Available under request | Disponível sob consulta | Disponible bajo consulta

SPARE PARTS | Complementos | Repuestos

Cutter Reference	Shim	Shim Pin	Order separately			Wrench
			Shim Pin Punch 	Lever 	Lever Screw 	
S25T PSKN R/L 12	-	-	-	AN12100	PA0601300	SS25
S32U PSKN R/L 12	CS120302	BE05500	BF47509	AC13200	PA0801700	SS30
S40V PSKN R/L 12	CS120302	BE05500	BF47509	AN13100	PA0802100	SS30
S40V PSKN R/L 15	CS150400	BE07000	BF65012	AN17100	PA0802300	SS30
S50W PSKN R/L 15	CS150400	BE07000	BF65012	AN17100	PA0802300	SS30
S50W PSKN R/L 19	CS190400	BE08300	BF80012	AN20200	PA1003000	SS40
S60Y PSKN R/L 19	CS150400	BE08300	BF80012	AN20200	PA1003000	SS40

C
TURNING
Insert selection
Overview
Negative inserts
Positive inserts
PCBN & PCD inserts
Heavy turning
External Toolholders
Internal Toolholders
Automatic Lathes
Spare Parts
Technical Data





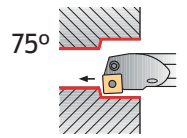

(P) LEVER LOCK TOOLHOLDERS

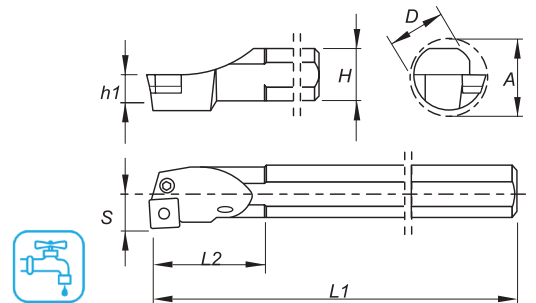
Roughing	Finishing	Medium	Medium
Flat	MF	SF	MR
 (12)	 (12)	 (12)	 (12)
Medium	Medium	Roughing to Medium	Roughing
PM	ST	SS	HR
 (12)	 (12)	 (12)	 (12)



Axial: -3°
Radial: -11°



Order Code		Reference	Dimensions (mm)							Insert	Kg	Stock	
R	L		D	H	h1	L1	L2	S	A			R	L
212347100	212347200	A25R PSKN R/L 12	25	23	11,5	200	40	17	31	SN.. 1204..	0,700		
212347300	212347400	A32S PSKN R/L 12	32	30	15,0	250	50	22	39	SN.. 1204..	1,400		
212347500	212347600	A40T PSKN R/L 12	40	37	18,5	300	60	27	48	SN.. 1204..	2,650		









 Stock Items | Itens de stock

Available under request | Disponível sob consulta | Disponible bajo consulta





SPARE PARTS || Complementos | Repuestos

Cutter Reference	Order separately					
	Shim	Shim Pin	Shim Pin Punch	Lever	Lever Screw	Wrench
A25R PSKN R/L 12	-	-	-	AN12100	PA0601300	SS25
A32S PSKN R/L 12	CS120302	BE05500	BF47509	AC13200	PA0801700	SS30
A40T PSKN R/L 12	CS120302	BE05500	BF47509	AN13100	PA0802100	SS30

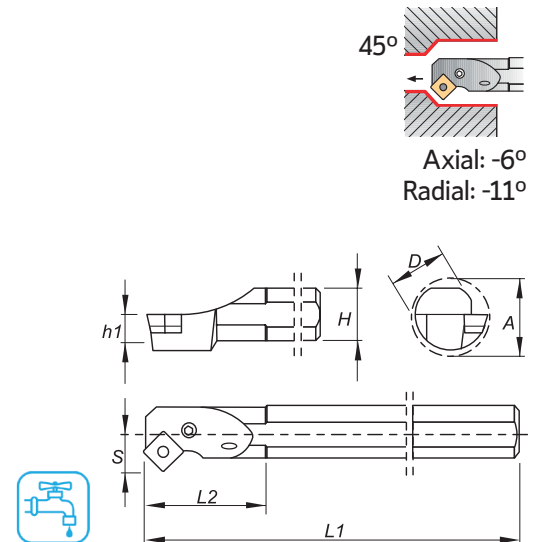
(P) LEVER LOCK TOOLHOLDERS

Roughing	Finishing	Medium	Medium
Flat  (12)	MF  (12)	SF  (12)	MR  (12)
Medium	Medium	Roughing to Medium	Roughing
PM  (12)	ST  (12)	SS  (12)	HR  (12)









Order Code		Reference	Dimensions (mm)							Insert	Kg	Stock	
R	L		D	H	h1	L1	L2	S	A			R	L
212347700	212347800	A25R PSSN R/L 12	25	23	11,5	200	40	17	31	SN.. 1204..	0,700		
212347900	212348000	A32S PSSN R/L 12	32	30	15,0	250	50	22	39	SN.. 1204..	2,050		











 Stock Items | Itens de stock

 Available under request | Disponível sob consulta | Disponible bajo consulta

SPARE PARTS || Complementos | Repuestos

Cutter Reference	Order separately					
	Shim	Shim Pin	Shim Pin Punch	Lever	Lever Screw	Wrench
A25R PSKN R/L 12						
A32S PSKN R/L 12	-	-	-	AN12100	PA0601300	SS25
A32S PSKN R/L 12	CS120302	BE05500	BF47509	AC13200	PA0801700	SS30

(P) LEVER LOCK TOOLHOLDERS

Roughing	Finishing	Medium to Finishing	Medium to Finishing	Medium	Medium
Flat  (16-22)	MF  (16-22)	SF  (16-22)	LC  (16-22)	MS  (16)	MR  (16-22)
Medium	Medium	Roughing to Medium	Roughing	Medium to Finishing	
PM  (16-22)	ST  (16-22)	SS  (16-22)	HR  (16-22)	O1  (16)	

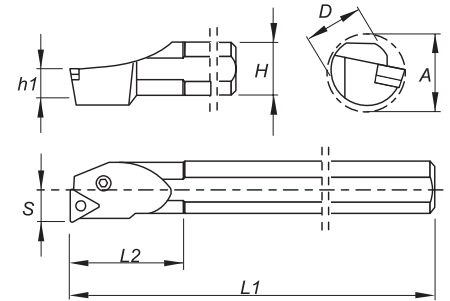
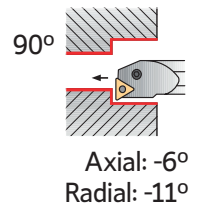

Order Code		Reference	Dimensions (mm)							Insert	Kg	Stock	
R	L		D	H	h1	L1	L2	S	A			R	L
212054300	212348100	S25T PTFN R/L 16	25	23	11,5	300	40	17	31	TN.. 1604..	0,700	⊗	⊗
212045000	212348200	S32U PTFN R/L 16	32	30	15,0	350	50	22	39	TN.. 1604..	2,050	○	○
212424700	212424800	S40V PTFN R/L 16	40	37	18,5	400	50	27	48	TN.. 1604..	3,750	○	○
212424900	212425000	S50W PTFN R/L 16	50	47	23,5	450	60	35	61	TN.. 1604..	6,500	○	○
212348300	212348400	S40V PTFN R/L 22	40	37	18,5	400	60	27	48	TN.. 2204..	3,750	○	○
212348500	212348600	S50W PTFN R/L 22	50	47	23,5	450	65	35	61	TN.. 2204..	6,500	○	○











⊗ Stock Items | Itens de stock

○ Available under request | Disponível sob consulta | Disponible bajo consulta





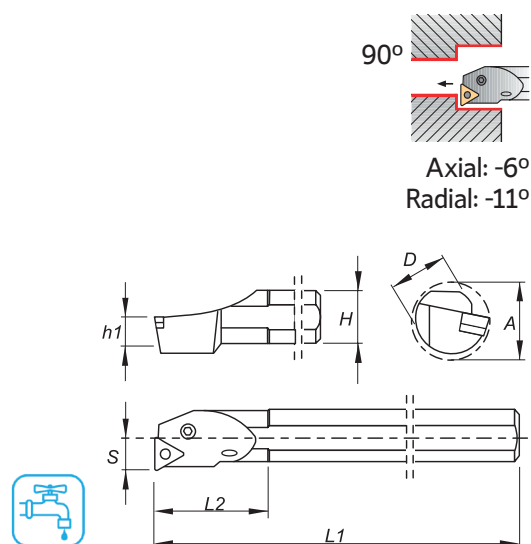

SPARE PARTS | Complementos | Repuestos

Cutter Reference	Order separately					
	Shim	Shim Pin	Shim Pin Punch	Lever	Lever Screw	Wrench
S25T PTFN R/L 16	-	-	-	AN09500	PA0501200	SS20
S32U PTFN R/L 16	CT160303	BE04400	BF40009	AN01200	PA0601700	SS25
S40V PTFN R/L 16	CT160303	BE04400	BF40009	AN01200	PA0601700	SS25
S50W PTFN R/L 16	CT160303	BE04400	BF40009	AN01200	PA0601700	SS25
S40V PTFN R/L 22	CT220302	BE05500	BF47509	AN13100	PA0802100	SS30
S50W PTFN R/L 22	CT220302	BE05500	BF47509	AN13100	PA0802100	SS30

(P) LEVER LOCK TOOLHOLDERS

Roughing	Finishing	Medium to Finishing	Medium to Finishing	Medium	Medium
Flat	MF	SF	LC	MS	MR
 (16-22)	 (16-22)	 (16-22)	 (16-22)	 (16)	 (16-22)
Medium	Medium	Roughing to Medium	Roughing	Medium to Finishing	
PM	ST	SS	HR	O1	
 (16-22)	 (16-22)	 (16-22)	 (16-22)	 (16)	









Order Code		Reference	Dimensions (mm)							Insert	Kg	Stock	
R	L		D	H	h1	L1	L2	S	A			R	L
212348700	212348800	A25R PTFN R/L 16	25	23	11,5	200	40	17	31	TN.. 1604..	0,700		
212348900	212349000	A32S PTFN R/L 16	32	30	15,0	250	50	22	39	TN.. 1604..	1,400		
212349100	212349200	A40T PTFN R/L 22	40	37	18,5	300	60	27	48	TN.. 2204..	2,650		











 Stock Items | Itens de stock

 Available under request | Disponível sob consulta | Disponible bajo consulta









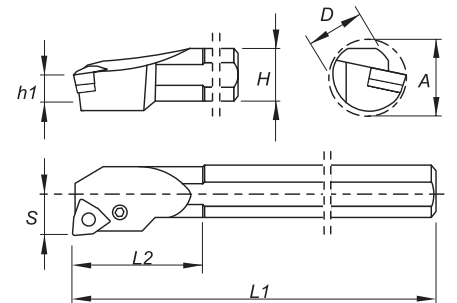
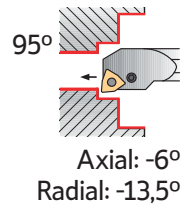



SPARE PARTS || Complementos | Repuestos

Cutter Reference	Order separately					
	Shim	Shim Pin	Shim Pin Punch	Lever	Lever Screw	Wrench
A25R PTFN R/L 16						
A25R PTFN R/L 16	-	-	-	AN09500	PA0501200	SS20
A32S PTFN R/L 16	CT160303	BE04400	BF40009	AN01200	PA0601700	SS25
A40T PTFN R/L 22	CT220302	BE05500	BF47509	AN13100	PA0802100	SS30

(P) LEVER LOCK TOOLHOLDERS

Roughing	Finishing	Medium to Finishing	Medium to Finishing	Medium	Medium
Flat  (06-08)	MF  (06-08)	SF  (06-08)	LC  (08)	MS  (06-08)	PM  (08)
Medium	Medium	Medium Wiper	Roughing to Medium	Roughing	
MR  (06-08)	ST  (08)	MW  (06-08)	SS  (06-08)	HR  (08)	









Order Code		Reference	Dimensions (mm)							Insert	Kg	Stock	
R	L		D	H	h1	L1	L2	S	A			R	L
212046300	212349300	S16R PWLN R/L 06	16	15	7,5	200	24	11	20	WN..0604..	0,300		
212219100	212349400	S20S PWLN R/L 06	20	18	9,0	250	36	13	27	WN..0604..	0,550		
212249900	212349500	S25T PWLN R/L 06	25	23	11,5	300	40	17	31	WN..0604..	0,700		
212046400	212349600	S25T PWLN R/L 08	25	23	11,5	300	40	17	31	WN..0804..	0,700		
212349700	212349800	S32U PWLN R/L 08	32	30	15,0	350	50	22	39	WN..0804..	2,050		
212349900	212350000	S40V PWLN R/L 08	40	37	18,5	400	60	27	48	WN..0804..	3,750		











 Stock Items | Itens de stock

 Available under request | Disponível sob consulta | Disponible bajo consulta









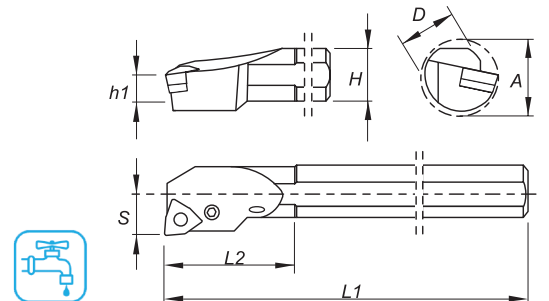
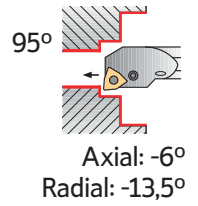





SPARE PARTS || Complementos | Repuestos

Cutter Reference	Order separately					
	Shim	Shim Pin	Shim Pin Punch	Lever	Lever Screw	Wrench
S16R PWLN R/L 06						
S20S PWLN R/L 06	-	-	-	AN09500	PA0501200	SS20
S25T PWLN R/L 06	CW060301	BE04400	BF40009	AN01200	PA0601700	SS25
S25T PWLN R/L 08	-	-	-	AC13200	PA0801700	SS30
S32U PWLN R/L 08	CW080300	BE05500	BF47509	AN13100	PA0802100	SS30
S40V PWLN R/L 08	CW080300	BE05500	BF47509	AN13100	PA0802100	SS30

(P) LEVER LOCK TOOLHOLDERS

Roughing	Finishing	Medium to Finishing	Medium to Finishing	Medium	Medium
Flat  (06-08)	MF  (06-08)	SF  (06-08)	LC  (08)	MS  (06-08)	PM  (08)
Medium	Medium	Medium Wiper	Roughing to Medium	Roughing	
MR  (06-08)	ST  (08)	MW  (06-08)	SS  (06-08)	HR  (08)	









Order Code		Reference	Dimensions (mm)							Insert	Kg	Stock	
R	L		D	H	h1	L1	L2	S	A			R	L
212350100	212350200	A16M PWLN R/L 06	16	15	7,5	150	24	11	20	WN..0604..	0,200		
212350300	212350400	A20Q PWLN R/L 06	20	18	9,0	180	36	13	27	WN..0604..	0,400		
212350500	212350600	A25R PWLN R/L 06	25	23	11,5	200	40	17	31	WN..0604..	0,700		
212350700	212350800	A32S PWLN R/L 06	32	30	15,0	250	50	22	39	WN..0604..	1,400		
212350900	212351000	A25R PWLN R/L 08	40	37	11,5	200	40	17	31	WN..0804..	0,700		
212351300	212351400	A32S PWLN R/L 08	32	30	15,0	250	50	22	39	WN..0804..	1,400		
212351100	212351200	A40T PWLN R/L 08	40	37	18,5	300	60	27	48	WN..0804..	2,650		

 Stock Items | Itens de stock

 Available under request | Disponivel sob consulta | Disponible bajo consulta

SPARE PARTS || Complementos | Repuestos

Cutter Reference	Order separately					
	Shim	Shim Pin	Shim Pin Punch	Lever	Lever Screw	Wrench
A16M PWLN R/L 06						
A20Q PWLN R/L 06	-	-	-	AN09500	PA0501200	SS20
A25R PWLN R/L 06	-	-	-	AN09500	PA0501200	SS20
A25R PWLN R/L 06	CW060301	BE04400	BF40009	AN01200	PA0601700	SS25
A32S PWLN R/L 06	CW060301	BE04400	BF40009	AN01200	PA0601700	SS25
A25R PWLN R/L 08	-	-	-	AC13200	PA0801700	SS30
A32S PWLN R/L 08	CW080300	BE05500	BF47509	AN13100	PA0802100	SS30
A40T PWLN R/L 08	CW080300	BE05500	BF47509	AN13100	PA0802100	SS30





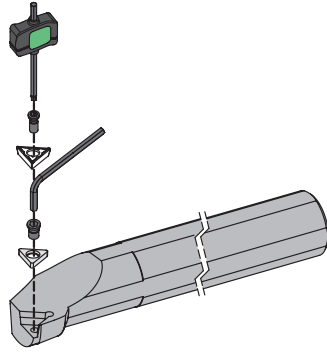







C
TURNING
Insert selection
Overview
Negative inserts
Positive inserts
PCBN & PCD inserts
Heavy turning
External Toolholders
Internal Toolholders
Spare Parts
Technical Data

(S) CENTER SCREW SYSTEM









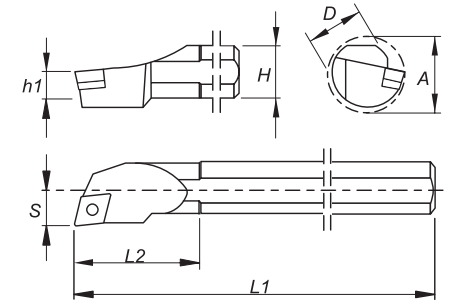
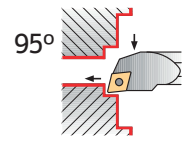



















SCLC 95° PAGE C - 645 CC.. 0602.. CC.. 09T3.. CC.. 1204..	A-SCLC 95° PAGE C - 646 CC.. 0602.. CC.. 09T3.. CC.. 1204..	E-SCLC 95° PAGE C - 647 CC.. 0602.. CC.. 09T3..	SCLCN 95° PAGE C - 648 CC.. 0602.. CC.. 09T3.. CC.. 1204..		
SDQC 107°30' PAGE C - 649 DC.. 0702.. DC.. 11T3..	A-SDQC 107°30' PAGE C - 650 DC.. 0702.. DC.. 11T3..				
SDUC 93° PAGE C - 651 DC.. 0702.. DC.. 11T3..	A-SDUC 93° PAGE C - 652 DC.. 0702.. DC.. 11T3..	E-SDUC 93° PAGE C - 653 DC.. 0702..	SDUC 93° - BT PAGE C - 654 DC.. 0702.. DC.. 11T3..	A-SDUC 93° - BT PAGE C - 655 DC.. 0702.. DC.. 11T3..	
SSKC 75° PAGE C - 656 SC..09T3.. SC.. 1204..	A-SSKC 45° PAGE C - 657 SC.. 09T3..	STFC 90° PAGE C - 658 TC.. 0902.. TC.. 1102.. TC.. 16T3..	A-STFC 90° PAGE C - 659 TC.. 0902.. TC.. 1102.. TC.. 16T3..	E-STFC 90° PAGE C - 660 TC.. 0902.. TC.. 1102..	
STUC 93° PAGE C - 661 TC.. 1102.. TC.. 16T3..	SVQC 107°30' PAGE C - 662 VC.. 1103.. VC.. 1604..	A-SVQC 107°30' PAGE C - 663 VC.. 1103.. VC.. 1604..	SVUB 93° PAGE C - 664 VB.. 1604..	SVUC 93° PAGE C - 665 VC.. 1103.. VC.. 1604..	A-SVUC 93° PAGE C - 666 VC.. 1103.. VC.. 1604..
A-SVJC 93° PAGE C - 667 VC.. 1103.. VC.. 1604..					

(S) CENTER SCREW TOOLHOLDERS

Finishing	Finishing	Finishing	Finishing	Finishing	Finishing wiper	Medium to Finishing
Flat  (06-09-12)	FP  (06-09-12)	BO  (06-09-12)	FM  (06-09-12)	FK  (06-09-12)	FW  (06-09)	LM  (06-09-12)
Medium	Medium	Medium	Medium to Finishing wiper	Finishing to Fine finishing	Medium to Finishing	
MP  (06-09-12)	MM  (06-09-12)	MK  (06-09-12)	MW  (06-09-12)	FS  (06-09)	LN  (06-09-12)	







Order Code		Reference	Dimensions (mm)							Insert	Kg	Stock	
R	L		D	H	h1	L1	L2	S	A			R	L
212046700	212141400	S08K SCLC R/L 06	8	7	3,5	125	16	5	11	CC.. 0602..	0,040		
212039800	212141500	S10M SCLC R/L 06	10	9	4,5	150	25	7	13	CC.. 0602..	0,060		
212047300	212141600	S12M SCLC R/L 06	12	11	5,5	150	25	9	16	CC.. 0602..	0,150		
212079200	212141700	S12M SCLC R/L 09	12	11	5,5	150	25	9	16	CC.. 09T3..	0,150		
212315200	212315300	S12Q SCLC R/L 09	12	11	5,5	180	25	9	16	CC.. 09T3..	0,150		
212041600	212044200	S16R SCLC R/L 09	16	15	7,5	200	30	11	20	CC.. 09T3..	0,300		
212141900	212141800	S20S SCLC R/L 09	20	18	9,0	250	35	13	24	CC.. 09T3..	0,550		
212142100	212142000	S25T SCLC R7L 09	25	23	11,5	300	40	17	31	CC.. 09T3..	0,550		
212047400	212142200	S20S SCLC R/L 12	20	18	9,0	250	35	13	24	CC.. 1204..	0,550		
212045500	212142300	S25T SCLC R/L 12	25	23	11,5	300	40	17	31	CC.. 1204..	0,700		
212142500	212142400	S32U SCLC R/L 12	32	30	15,0	350	50	22	39	CC.. 1204..	2,050		
212142700	212142600	S40V SCLC R/L 12	40	37	18,5	400	60	27	48	CC.. 1204..	3,750		
212142900	212142800	S50W SCLC R/L 12	50	47	23,5	450	65	35	61	CC.. 1204..	6,500		

 Stock Items | Itens de stock









 Available under request | Disponível sob consulta | Disponible bajo consulta

SPARE PARTS || Complementos | Repuestos

Cutter Reference	Shim	Shim S crew	Screw	Wrench
S08K SCLC R/L 06				
S08K SCLC R/L 06	-	-	P0200601	XT07
S10M SCLC R/L 06	-	-	P0200601	XT07
S12M SCLC R/L 06	-	-	P0200601	XT07
S12M SCLC R/L 09	-	-	P0400802	XT15-S35
S12Q SCLC R/L 09	-	-	P0400802	XT15-S35
S16R SCLC R/L 09	-	-	P0400802	XT15-S35
S20S SCLC R/L 09	-	-	P0400802	XT15-S35
S25T SCLC R7L 09	-	-	P0400802	XT15-S35
S20S SCLC R/L 12	-	-	P0501200	XT15-S40
S25T SCLC R/L 12	-	-	P0501200	XT15-S40
S32U SCLC R/L 12	CC120401	T06004000	P0401400	XT15-S40
S40V SCLC R/L 12	CC120401	T06004000	P0401400	XT15-S40
S50W SCLC R/L 12	CC120401	T06004000	P0401400	XT15-S40

TURNING
Insert selection
Overview
Negative inserts
Positive inserts
PCBN & PCD inserts
Heavy turning
External Toolholders
Internal Toolholders
Automatic Lathes
Spare Parts
Technical Data

(S) CENTER SCREW TOOLHOLDERS

Finishing	Finishing	Finishing	Finishing	Finishing	Finishing wiper	Medium to Finishing
Flat  (06-09-12)	FP  (06-09-12)	BO  (06-09-12)	FM  (06-09-12)	FK  (06-09-12)	FW  (06-09)	LM  (06-09-12)
Medium	Medium	Medium	Medium to Finishing wiper	Finishing to Fine finishing	Medium to Finishing	
MP  (06-09-12)	MM  (06-09-12)	MK  (06-09-12)	MW  (06-09-12)	FS  (06-09)	LN  (06-09-12)	

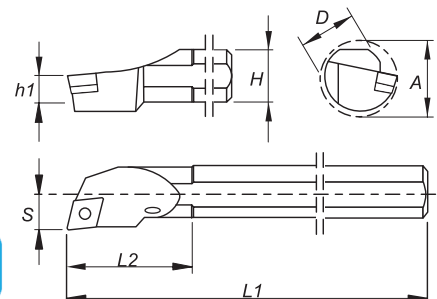
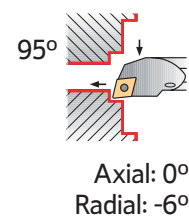

Order Code		Reference	Dimensions (mm)							Insert	Kg	Stock	
R	L		D	H	h1	L1	L2	S	A			R	L
212315400	212315500	A08F SCLC R/L 06	8	7	3,5	80	16	5	11	CC.. 0602..	0,030		
212315600	212315700	A10H SCLC R/L 06	10	9	4,5	100	25	7	13	CC.. 0602..	0,040		
212315800	212315900	A12K SCLC R/L 06	12	11	5,5	125	25	9	16	CC.. 0602..	0,100		
212316000	212316100	A16M SCLC R/L 09	16	15	7,5	150	30	11	20	CC.. 09T3..	0,200		
212316200	212316300	A20Q SCLC R/L 09	20	18	9,0	180	35	13	24	CC.. 09T3..	0,400		
212316400	212316500	A25R SCLC R/L 09	25	23	11,5	200	40	17	31	CC.. 09T3..	0,700		
212316600	212316700	A32S SCLC R/L 12	32	30	15,0	250	50	22	39	CC.. 1204..	1,400		
212316800	212316900	A40T SCLC R/L 12	40	37	18,5	300	60	27	48	CC.. 1204..	2,650		













Stock Itens | Itens de stock

Available under request | Disponível sob consulta | Disponible bajo consulta







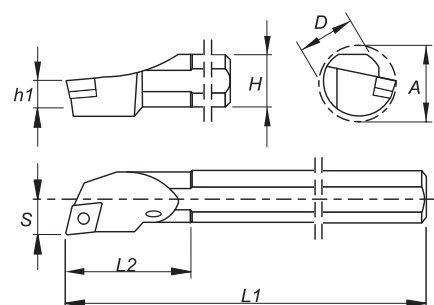
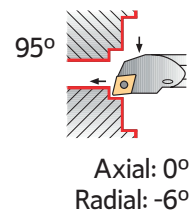

SPARE PARTS || Complementos | Repuestos

Cutter Reference	Shim	Shim S crew	Screw	Wrench
A08F SCLC R/L 06				
A10H SCLC R/L 06	-	-	P0200601	XT07
A12K SCLC R/L 06	-	-	P0200601	XT07
A16M SCLC R/L 09	-	-	P0400802	XT15-S35
A20Q SCLC R/L 09	-	-	P0400802	XT15-S35
A25R SCLC R/L 09	-	-	P0400802	XT15-S35
A32S SCLC R/L 12	CC120401	T06004000	P0401400	XT15-S40
A40T SCLC R/L 12	CC120401	T06004000	P0401400	XT15-S40

(S) CENTER SCREW TOOLHOLDERS

Finishing	Finishing	Finishing	Finishing	Finishing	Finishing wiper	Medium to Finishing
Flat  (06-09)	FP  (06-09)	BO  (06-09)	FM  (06-09)	FK  (06-09)	FW  (06-09)	LM  (06-09)
Medium	Medium	Medium	Medium to Finishing wiper	Finishing to Fine finishing	Medium to Finishing	
MP  (06-09)	MM  (06-09)	MK  (06-09)	MW  (06-09)	FS  (06-09)	LN  (06-09)	



Order Code		Reference	Dimensions (mm)							Insert	Kg	Stock	
R	L		D	H	h1	L1	L2	S	A			R	L
212317800	212317900	E08K SCLC R/L 06	8	7	3,5	125	16	5	11	CC.. 0602..	0,080		
212318000	212318100	E10M SCLC R/L 06	10	9	4,5	150	25	7	13	CC.. 0602..	0,150		
212317400	212318300	E12Q SCLC R/L 06	12	11	5,5	180	25	9	16	CC.. 0602..	0,250		
212318400	212317600	E16R SCLC R/L 09	16	15	7,5	200	30	11	20	CC.. 09T3..	0,600		







 Stock items | Itens de stock

 Available under request | Disponível sob consulta | Disponible bajo consulta

SPARE PARTS | Complementos | Repuestos

Cutter Reference	Screw	Wrench
		
E08K SCLC R/L 06	P0200601	XT07
E10M SCLC R/L 06	P0200601	XT07
E12M SCLC R/L 06	P0200601	XT07
E16R SCLC R/L 09	P0400802	XT15-S35

(S) CENTER SCREW TOOLHOLDERS

Finishing	Finishing	Finishing	Finishing	Finishing	Finishing wiper	Medium to Finishing
Flat  (06-09-12)	FP  (06-09-12)	BO  (06-09-12)	FM  (06-09-12)	FK  (06-09-12)	FW  (06-09)	LM  (06-09-12)
Medium	Medium	Medium	Medium to Finishing wiper	Finishing to Fine finishing	Medium to Finishing	
MP  (06-09-12)	MM  (06-09-12)	MK  (06-09-12)	MW  (06-09-12)	FS  (06-09)	LN  (06-09-12)	

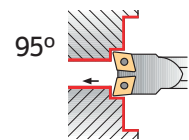

Axial: 0°
Radial: -9°

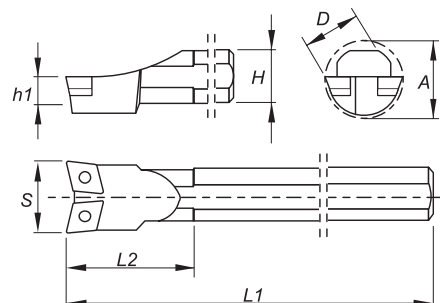





Order Code	Reference	Dimensions (mm)								Insert	Kg	Stock
		D	H	h1	L1	L2	S	A				
212143000	S12M SCLC N 06	12	11	5,5	150	25	18	20	CC.. 0602..	0,150	⊗	
212143100	S16R SCLC N 06	16	15	7,5	200	30	22	25	CC.. 0602..	0,300	⊗	
212143200	S20S SCLC N 06	20	18	9,0	250	35	26	30	CC.. 0602..	0,550	⊗	
212143300	S25T SCLC N 09	25	23	11,5	300	40	34	40	CC.. 09T3..	0,700	⊗	
212143400	S32U SCLC N 12	32	30	15,0	350	50	44	50	CC.. 1204..	2,050	○	
212143500	S40V SCLC N 12	40	37	18,5	400	60	54	60	CC.. 1204..	3,750	○	
212143600	S50W SCLC N 12	50	47	23,5	450	65	62	68	CC.. 1204..	6,500	○	





⊗ Stock Items | Itens de stock

○ Available under request | Disponível sob consulta | Disponible bajo consulta



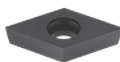
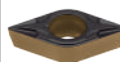

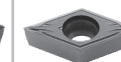
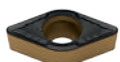

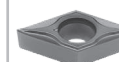
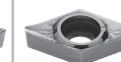

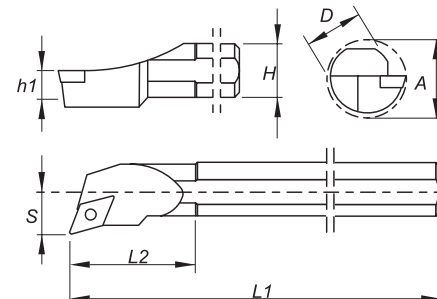
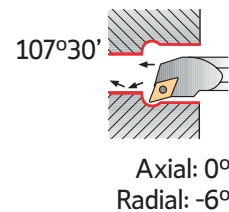







SPARE PARTS || Complementos | Repuestos

Cutter Reference	Shim 	Shim Screw 	Screw 	Wrench 
S12M SCLC N 06	-	-	P0200601	XT07
S16R SCLC N 06	-	-	P0200601	XT07
S20S SCLC N 06	-	-	P0200601	XT07
S25T SCLC N 09	-	-	P0400802	XT15-S35
S32U SCLC N 12	CC120401	T06004000	P0401400	XT15-S40
S40V SCLC N 12	CC120401	T06004000	P0401400	XT15-S40
S50W SCLC N 12	CC120401	T06004000	P0401400	XT15-S40

(S) CENTER SCREW TOOLHOLDERS

Finishing	Finishing	Finishing	Finishing	Medium to Finishing
Flat	FP	FM	FK	LM
 (07-11)	 (07-11)	 (07-11)	 (07-11)	 (07-11)
Medium	Medium	Medium	Finishing to Fine Finishing	Finishing to Fine Finishing
MP	MM	MK	FS	LN
 (07-11)	 (07-11)	 (07-11)	 (07-11)	 (07-11)







Order Code		Reference	Dimensions (mm)							Insert	Kg	Stock	
R	L		D	H	h1	L1	L2	S	A			R	L
212147000	212146900	S10M SDQC R/L 07	10	9	4,5	150	25	7	13	DC.. 0702..	0,060		
212147200	212147100	S12M SDQC R/L 07	12	11	5,5	150	25	9	16	DC.. 0702..	0,150		
212147400	212147300	S16R SDQC R/L 07	16	15	7,5	200	30	11	20	DC.. 0702..	0,300		
212147600	212147500	S20S SDQC R/L 07	20	18	9,0	250	35	13	24	DC.. 0702..	0,550		
212147800	212147700	S20S SDQC R/L 11	20	18	9,0	250	35	13	24	DC.. 11T3..	0,550		
212148000	212147900	S25T SDQC R/L 11	25	23	11,5	300	40	17	31	DC.. 11T3..	0,700		
212148100	212148200	S32U SDQC R/L 11	32	30	15,0	350	50	22	39	DC.. 11T3..	2,050		
212148300	212148400	S40V SDQC R/L 11	40	37	18,5	400	60	27	48	DC.. 11T3..	3,750		

 Stock Items | Itens de stock







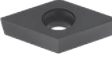

 Available under request | Disponível sob consulta | Disponible bajo consulta

SPARE PARTS | Complementos | Repuestos

Cutter Reference	Shim	Shim Screw	Screw	Wrench
S10M SDQC R/L 07				
S12M SDQC R/L 07	-	-	P0200601	XT07
S16R SDQC R/L 07	-	-	P0250700	XT07
S20S SDQC R/L 07	-	-	P0250700	XT07
S20S SDQC R/L 11	-	-	P0401100	XT15-S35
S25T SDQC R/L 11	-	-	P0401100	XT15-S35
S32U SDQC R/L 11	CD110301	T05003500	P0351500	XT15-S35
S40V SDQC R/L 11	CD110301	T05003500	P0351500	XT15-S35

TURNING
Insert selection
Overview
Negative inserts
Positive inserts
PCBN & PCD inserts
Heavy turning
External Toolholders
Internal Toolholders
Automatic Lathes
Spare Parts
Technical Data



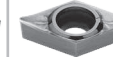

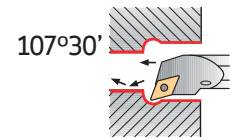



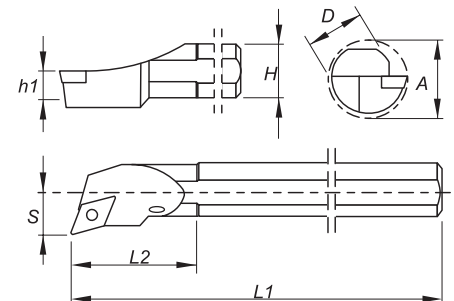



(S) CENTER SCREW TOOLHOLDERS

Finishing	Finishing	Finishing	Finishing	Medium to Finishing
Flat  (07-11)	FP  (07-11)	FM  (07-11)	FK  (07-11)	LM  (07-11)
Medium	Medium	Medium	Finishing to Fine Finishing	Finishing to Fine Finishing
MP  (07-11)	MM  (07-11)	MK  (07-11)	FS  (07-11)	LN  (07-11)



Axial: 0°
Radial: -6°







Order Code		Reference	Dimensions (mm)							Insert	Kg	Stock	
R	L		D	H	h1	L1	L2	S	A			R	L
212318600	212318700	A12K SDQC R/L 07	12	11	5,5	125	25	9	16	DC.. 0702..	0,100		
212318800	212318900	A16M SDQC R/L 07	16	15	7,5	150	30	11	20	DC.. 0702..	0,200		
212319000	212319100	A20Q SDQC R/L 11	20	18	9,0	180	35	13	24	DC.. 11T3..	0,400		
212319200	212319300	A25R SDQC R/L 11	25	23	11,5	200	40	17	31	DC.. 11T3..	0,700		
212319400	212319500	A32S SDQC R/L 11	32	30	15,0	250	50	22	39	DC.. 11T3..	1,400		
212319600	212319700	A40T SDQC R/L 11	40	37	18,5	300	60	27	48	DC.. 11T3..	2,650		







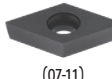

 Stock Items | Itens de stock

 Available under request | Disponível sob consulta | Disponible bajo consulta

SPARE PARTS | Complementos | Repuestos

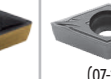
Cutter Reference	Shim	Shim Screw	Screw	Wrench
A12K SDQC R/L 07				
A16M SDQC R/L 07	-	-	P0250700	XT07
A20Q SDQC R/L 11	-	-	P0401100	XT15-S35
A25R SDQC R/L 11	-	-	P0401100	XT15-S35
A32S SDQC R/L 11	CD110301	T05003500	P0351500	XT15-S35
A40T SDQC R/L 11	CD110301	T05003500	P0351500	XT15-S35



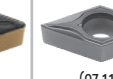
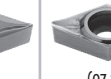

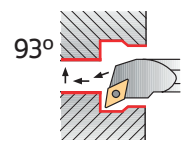



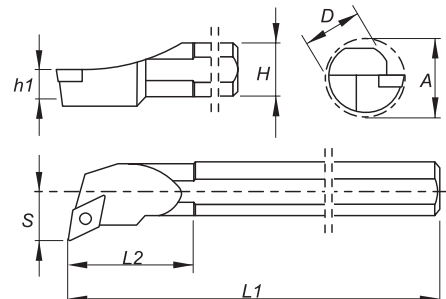









(S) CENTER SCREW TOOLHOLDERS

Finishing	Finishing	Finishing	Finishing	Finishing wiper	Medium to Finishing
Flat	FP	FM	FK	FW	LM
 (07-11)	 (07-11)	 (07-11)	 (07-11)	 (07-11)	 (07-11)
Medium	Medium	Medium	Medium to Finishing wiper	Finishing to Fine Finishing	Finishing to Fine Finishing
MP	MM	MK	MW	FS	LN
 (07-11)	 (07-11)	 (07-11)	 (11)	 (07-11)	 (07-11)



Axial: 0°
Radial: -6°







Order Code		Reference	Dimensions (mm)							Insert	Kg	Stock	
R	L		D	H	h1	L1	L2	S	A			R	L
212144700	212144600	S10M SDUC R/L 07	10	9	4,5	150	25	7	13	DC.. 0702..	0,060		
212028500	212028600	S12M SDUC R/L 07	12	11	5,5	150	25	9	16	DC.. 0702..	0,150		
212319800	212319900	S12Q SDUC R/L 07	12	11	5,5	180	25	9	16	DC.. 0702..	0,150		
212028700	212028800	S16R SDUC R/L 07	16	15	7,5	200	30	11	20	DC.. 0702..	0,300		
212144900	212144800	S20S SDUC R/L 07	20	18	9,0	250	35	13	24	DC.. 0702..	0,550		
212036800	212028900	S20S SDUC R/L 11	20	18	9,0	250	35	13	24	DC.. 11T3..	0,550		
212029000	212038400	S25T SDUC R/L 11	25	23	11,5	300	40	17	31	DC.. 11T3..	0,700		
212145200	212145100	S32U SDUC R/L 11	32	30	15,0	350	50	22	39	DC.. 11T3..	2,050		
212145400	212145300	S40V SDUC R/L 11	40	37	18,5	400	60	27	48	DC.. 11T3..	3,750		

 Stock items | Itens de stock











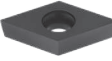

 Available under request | Disponível sob consulta | Disponible bajo consulta

SPARE PARTS | Complementos | Repuestos

Cutter Reference	Shim	Shim Screw	Screw	Wrench
S10M SDUC R/L 07				
S12M SDUC R/L 07	-	-	P0200601	XT07
S12Q SDUC R/L 07	-	-	P0250700	XT07
S16R SDUC R/L 07	-	-	P0250700	XT07
S20S SDUC R/L 07	-	-	P0250700	XT07
S20S SDUC R/L 11	-	-	P0401100	XT15-S35
S25T SDUC R/L 11	-	-	P0401100	XT15-S35
S32U SDUC R/L 11	CD110301	T05003500	P0351500	XT15-S40
S40V SDUC R/L 11	CD110301	T05003500	P0351500	XT15-S40

C
TURNING
Insert selection
Overview
Negative inserts
Positive inserts
PCBN & PCD inserts
Heavy turning
External Toolholders
Internal Toolholders
Automatic Lathes
Spare Parts
Technical Data





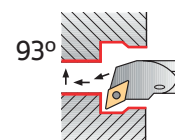



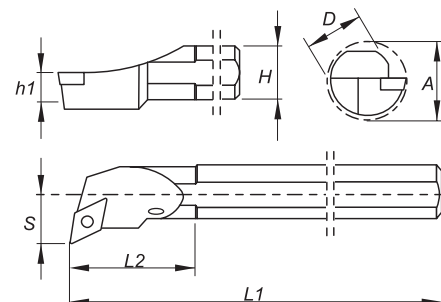



(S) CENTER SCREW TOOLHOLDERS

Finishing	Finishing	Finishing	Finishing	Finishing wiper	Medium to Finishing
Flat  (07-11)	FP  (07-11)	FM  (07-11)	FK  (07-11)	FW  (07-11)	LM  (07-11)
Medium	Medium	Medium	Medium to Finishing wiper	Finishing to Fine Finishing	Finishing to Fine Finishing
MP  (07-11)	MM  (07-11)	MK  (07-11)	MW  (11)	FS  (07-11)	LN  (07-11)



Axial: 0°
Radial: -6°







Order Code		Reference	Dimensions (mm)							Insert	Kg	Stock	
R	L		D	H	h1	L1	L2	S	A			R	L
212320000	212320100	A12K SDUC R/L 07	12	11	5,5	125	25	9	16	DC.. 0702..	0,100		
212320200	212320300	A16M SDUC R/L 07	16	15	7,5	150	30	11	20	DC.. 0702..	0,200		
212320400	212320500	A20Q SDUC R/L 11	20	18	9,0	180	35	13	24	DC.. 11T3..	0,400		
212320600	212320700	A25R SDUC R/L 11	25	23	11,5	200	40	17	31	DC.. 11T3..	0,700		
212320800	212320900	A32S SDUC R/L 11	32	30	15,0	250	50	22	39	DC.. 11T3..	1,400		
212321000	212321100	A40T SDUC R/L 11	40	37	18,5	300	60	27	48	DC.. 11T3..	2,650		







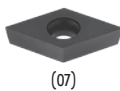
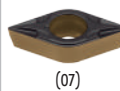

 Stock Items | Itens de stock

 Available under request | Disponível sob consulta | Disponible bajo consulta

SPARE PARTS | Complementos | Repuestos

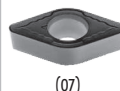
Cutter Reference	Shim	Shim Screw	Screw	Wrench
A12K SDUC R/L 07				
A16M SDUC R/L 07	-	-	P0250700	XT07
A20Q SDUC R/L 11	-	-	P0401100	XT15-S35
A25R SDUC R/L 11	-	-	P0401100	XT15-S35
A32S SDUC R/L 11	CD110301	T05003500	P0351500	XT15-S35
A40T SDUC R/L 11	CD110301	T05003500	P0351500	XT15-S35

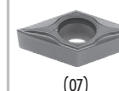
(S) CENTER SCREW TOOLHOLDERS

Finishing	Finishing	Finishing	Finishing	Finishing wiper
Flat	FP	FM	FK	FW
 (07)	 (07)	 (07)	 (07)	 (07)
Medium	Medium	Medium	Finishing to Fine Finishing	Finishing to Fine Finishing
MP	MM	MK	FS	LN
 (07)	 (07)	 (07)	 (07)	 (07)

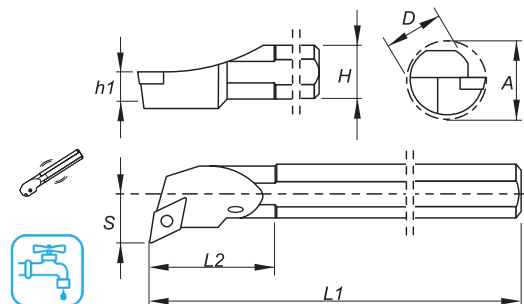
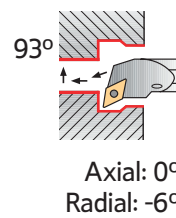

Order Code		Reference	Dimensions (mm)							Insert	Kg	Stock	
R	L		D	H	h1	L1	L2	S	A			R	L
212321800	212321300	E10M SDUC R/L 07	10	9	4,5	150	25	7	13	DC.. 0702..	0,150	⊗	⊗
212322000	212322100	E12Q SDUC R/L 07	12	11	5,5	180	25	9	16	DC.. 0702..	0,250	⊗	⊗
212322200	212321700	E16R SDUC R/L 07	16	15	7,5	200	30	11	20	DC.. 0702..	0,600	⊗	⊗









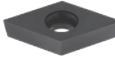
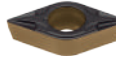

⊗ Stock Items | Itens de stock

○ Available under request | Disponível sob consulta | Disponible bajo consulta

SPARE PARTS || Complementos | Repuestos

Cutter Reference	Screw	Wrench
		
E10M SDUC R/L 07	P0200601	XT07
E12M SDUC R/L 07	P0250700	XT07
E16R SDUC R/L 07	P0250700	XT07





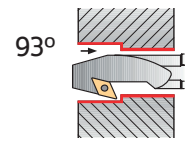



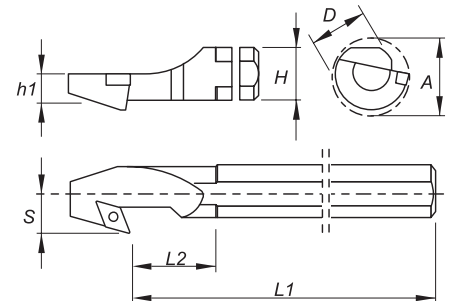





(S) CENTER SCREW TOOLHOLDERS

Finishing	Finishing	Finishing	Finishing	Finishing wiper	Medium to Finishing
Flat	FP	FM	FK	FW	LM
 (07-11)	 (07-11)	 (07-11)	 (07-11)	 (07-11)	 (07-11)
Medium	Medium	Medium	Medium to Finishing wiper	Finishing to Fine Finishing	Finishing to Fine Finishing
MP	MM	MK	MW	FS	LN
 (07-11)	 (07-11)	 (07-11)	 (11)	 (07-11)	 (07-11)



Axial: 0°
Radial: -6°







Order Code		Reference	Dimensions (mm)							Insert	Kg	Stock	
R	L		D	H	h1	L1	L2	S	A			R	L
212145600	212145500	S12M SDUC R/L 07-BT	12	11	5,5	150	25	9	16	DC.. 0702..	0,150		
212145800	212145700	S16R SDUC R/L 07-BT	16	15	7,5	200	30	11	20	DC.. 0702..	0,300		
212146000	212145900	S20S SDUC R/L 07-BT	20	18	9,0	250	35	13	24	DC.. 0702..	0,550		
212146200	212146100	S20S SDUC R/L 11-BT	20	18	9,0	250	35	13	24	DC.. 11T3..	0,550		
212146400	212146300	S25T SDUC R/L 11-BT	25	23	11,5	300	40	17	31	DC.. 11T3..	0,700		
212146600	212146500	S32U SDUC R/L 11-BT	32	30	15,0	350	50	22	39	DC.. 11T3..	2,050		
212146800	212146700	S40V SDUC R/L 11-BT	40	37	18,5	400	60	27	48	DC.. 11T3..	3,750		











 Stock Items | Itens de stock

 Available under request | Disponível sob consulta | Disponible bajo consulta

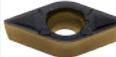
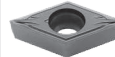



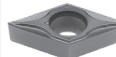

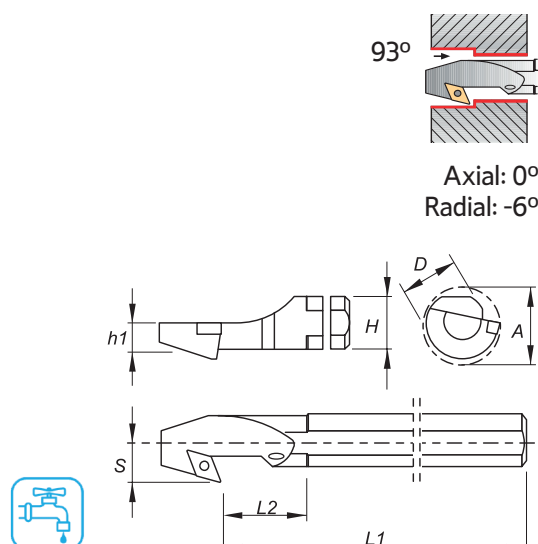

SPARE PARTS || Complementos | Repuestos

Cutter Reference	Shim	Shim Screw	Screw	Wrench
S12M SDUC R/L 07-BT				
S16R SDUC R/L 07-BT	-	-	P0250700	XT07
S20S SDUC R/L 07-BT	-	-	P0250700	XT07
S20S SDUC R/L 11-BT	-	-	P0400802	XT15-S35
S25T SDUC R/L 11-BT	-	-	P0401100	XT15-S35
S32U SDUC R/L 11-BT	CD110301	T05003500	P0351500	XT15-S35
S40V SDUC R/L 11-BT	CD110301	T05003500	P0351500	XT15-S35

(S) CENTER SCREW TOOLHOLDERS

Finishing	Finishing	Finishing	Finishing	Finishing wiper	Medium to Finishing
Flat	FP	FM	FK	FW	LM
 (07-11)	 (07-11)	 (07-11)	 (07-11)	 (07-11)	 (07-11)
Medium	Medium	Medium	Medium to Finishing wiper	Finishing to Fine Finishing	Finishing to Fine Finishing
MP	MM	MK	MW	FS	LN
 (07-11)	 (07-11)	 (07-11)	 (11)	 (07-11)	 (07-11)



Order Code		Reference	Dimensions (mm)							Insert	Kg	Stock	
R	L		D	H	h1	L1	L2	S	A			R	L
212322400	212322500	A12K SDUC R/L 07-BT	12	11	5,5	125	25	9	16	DC.. 0702..	0,100		
212322600	212322700	A16M SDUC R/L 07-BT	16	15	7,5	150	30	11	20	DC.. 0702..	0,200		
212322800	212322900	A20Q SDUC R7L 11-BT	20	18	9,0	180	35	13	24	DC.. 11T3..	0,400		
212323000	212323100	A25R SDUC R/L 11-BT	25	23	11,5	200	40	17	31	DC.. 11T3..	0,700		

 Stock Items | Itens de stock

 Available under request | Disponível sob consulta | Disponible bajo consulta

SPARE PARTS || Complementos | Repuestos





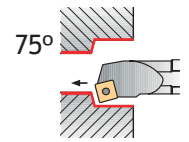

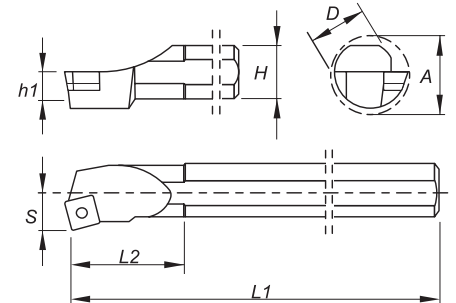

Cutter Reference	Screw	Wrench
		
A12K SDUC R/L 07-BT	P0250700	XT07
A16M SDUC R/L 07-BT	P0250700	XT07
A20Q SDUC R7L 11-BT	P0400802	XT15-S35
A25R SDUC R/L 11-BT	P0401100	XT15-S35













(S) CENTER SCREW TOOLHOLDERS



Axial: 0°
Radial: -8°







Finishing	Finishing	Finishing	Finishing
Flat  (09-12)	FP  (09)	FM  (09)	FK  (09)
Medium	Medium	Medium	Medium to Finishing
MP  (09-12)	MM  (09-12)	MK  (09-12)	LN  (09-12)

Order Code		Reference	Dimensions (mm)							Insert	Kg	Stock	
R	L		D	H	h1	L1	L2	S	A			R	L
212150400	212150300	S16R SSKC R/L 09	16	15	7,5	200	30	11	20	SC.. 09T3..	0,300		
212150600	212150500	S20S SSKC R/L 09	20	18	9,0	250	35	13	24	SC.. 09T3..	0,550		
212045800	212150700	S25T SSKC R/L 09	25	23	11,5	300	40	17	31	SC.. 09T3..	0,700		
212045900	212150800	S32U SSKC R/L 12	32	30	15,0	350	50	22	39	SC.. 1204..	2,050		
212151000	212150900	S40V SSKC R/L 12	40	37	18,5	400	60	27	48	SC.. 1204..	3,750		
212151200	212151100	S50W SSKC R/L 12	50	47	23,5	450	65	35	61	SC.. 1204..	6,500		









 Stock Items | Itens de stock

 Available under request | Disponível sob consulta | Disponible bajo consulta

SPARE PARTS | Complementos | Repuestos

Cutter Reference	Shim 	Shim Screw 	Screw 	Wrench 
S16R SSKC R/L 09	-	-	P0400802	XT15-S35
S20S SSKC R/L 09	-	-	P0400802	XT15-S35
S25T SSKC R/L 09	-	-	P0400802	XT15-S35
S32U SSKC R/L 12	CC120400	T06004000	P0401400	XT15-S40
S40V SSKC R/L 12	CC120400	T06004000	P0401400	XT15-S40
S50W SSKC R/L 12	CC120400	T06004000	P0401400	XT15-S40





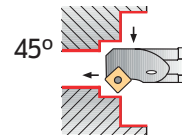

(S) CENTER SCREW TOOLHOLDERS

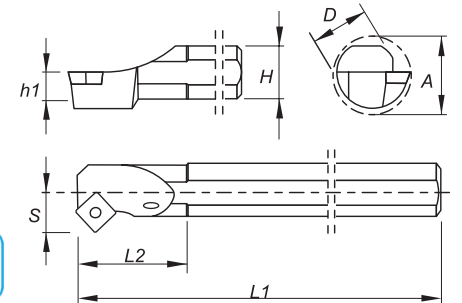
Finishing	Finishing	Finishing	Finishing
Flat	FP	FM	FK
 (09)	 (09)	 (09)	 (09)
Medium	Medium	Medium	Medium to Finishing
MP	MM	MK	LN
 (09)	 (09)	 (09)	 (09)



Axial: 0°
Radial: -8°



Order Code		Reference	Dimensions (mm)							Insert	Kg	Stock	
R	L		D	H	h1	L1	L2	S	A			R	L
212323200	212323300	A16M SSSC R/L 09	16	15	7,5	150	30	11	20	SC.. 09T3..	0,300		
212323400	212323500	A20Q SSSC R/L 09	20	18	9,0	180	35	13	24	SC.. 09T3..	0,550		
212323600	212323700	A25R SSSC R/L 09	25	23	11,5	200	40	17	31	SC.. 09T3..	0,700		









 Stock Items | Itens de stock

 Available under request | Disponível sob consulta | Disponible bajo consulta

SPARE PARTS | Complementos | Repuestos

Cutter Reference	Screw	Wrench
		
A16M SSSC R/L 09	P0400802	XT15-S35
A20Q SSSC R/L 09	P0400802	XT15-S35
A25R SSSC R/L 09	P0400802	XT15-S35





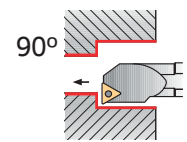



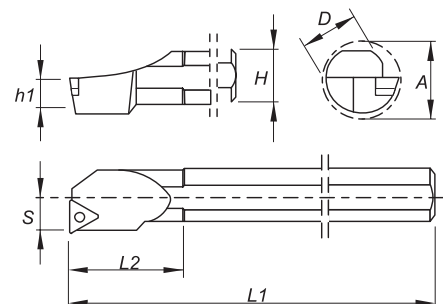











(S) CENTER SCREW TOOLHOLDERS

Finishing	Finishing	Finishing	Finishing
Flat  (09-11-16)	FP  (09-11-16)	FM  (09-11-16)	FK  (09-11-16)
Medium	Medium	Medium	Medium to Finishing
MP  (09-11-16)	MM  (09-11-16)	MK  (09-11-16)	LN  (11-16)



Axial: 0°
Radial: -6°







Order Code		Reference	Dimensions (mm)							Insert	Kg	Stock	
R	L		D	H	h1	L1	L2	S	A			R	L
212159500	212159400	S10M STFC R/L 09	10	9	4,5	150	25	7	13	TC.. 0902..	0,060		
212159700	212159600	S12M STFC R/L 09	12	11	5,5	150	25	9	16	TC.. 0902..	0,150		
212039500	212159800	S12M STFC R/L 11	12	11	5,5	150	25	9	16	TC.. 1102..	0,150		
212323800	212323900	S12Q STFC R/L 11	12	11	5,5	180	25	9	16	TC.. 1102..	0,050		
212160000	212159900	S16R STFC R/L 11	16	15	7,5	200	30	11	20	TC.. 1102..	0,300		
212021000	212160100	S20S STFC R/L 11	20	18	9,0	250	35	13	24	TC.. 1102..	0,550		
212250700	212324000	S20S STFC R/L 16	20	18	9,0	250	35	13	24	TC.. 16T3..	0,550		
212160300	212160200	S25T STFC R/L 16	25	23	11,5	300	40	17	31	TC.. 16T3..	0,700		
212160500	212160400	S32U STFC R/L 16	32	30	15,0	350	50	22	39	TC.. 16T3..	2,050		
212160700	212160600	S40V STFC R/L 16	40	37	18,5	400	60	27	48	TC.. 16T3..	3,750		









 Stock Items | Itens de stock

 Available under request | Disponível sob consulta | Disponible bajo consulta









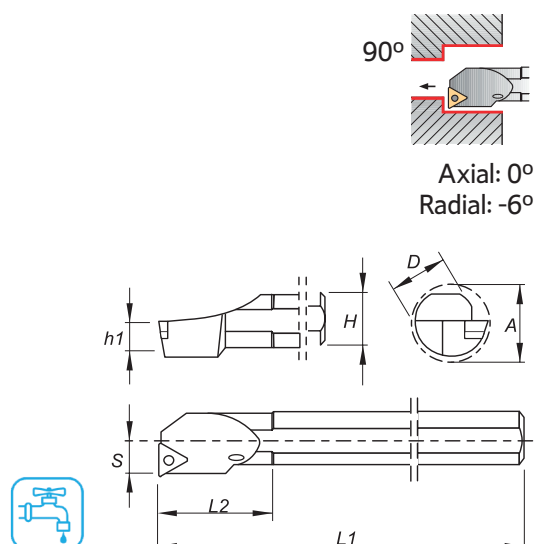





SPARE PARTS || Complementos | Repuestos

Cutter Reference	Shim	Shim Screw	Screw	Wrench
S10M STFC R/L 09				
S12M STFC R/L 09	-	-	P0220600	XT06
S12M STFC R/L 11	-	-	P0250700	XT07
S12Q STFC R/L 11	-	-	P0250700	XT07
S16R STFC R/L 11	-	-	P0250700	XT07
S20S STFC R/L 11	-	-	P0250700	XT07
S20S STFC R/L 16	-	-	P0401100	XT15-S35
S25T STFC R/L 16	-	-	P0401100	XT15-S35
S32U STFC R/L 16	CT160302	T05003500	P0351500	XT15-S35
S40V STFC R/L 16	CT160302	T05003500	P0351500	XT15-S35

(S) CENTER SCREW TOOLHOLDERS

Finishing	Finishing	Finishing	Finishing
Flat	FP	FM	FK
 (09-11-16)	 (09-11-16)	 (09-11-16)	 (09-11-16)
Medium	Medium	Medium	Medium to Finishing
MP	MM	MK	LN
 (09-11-16)	 (09-11-16)	 (09-11-16)	 (11-16)







Order Code		Reference	Dimensions (mm)							Insert	Kg	Stock	
R	L		D	H	h1	L1	L2	S	A			R	L
212324100	212324200	A10H STFC R/L 09	10	9	4,5	100	25	7	13	TC.. 0902..	0,040		
212324300	212324400	A12K STFC R/L 11	12	11	5,5	125	25	9	16	TC.. 1102..	0,100		
212324500	212324600	A16M STFC R/L 11	16	15	7,5	150	30	11	20	TC.. 1102..	0,200		
212324700	212324800	A20Q STFC R/L 11	20	18	9,0	180	35	13	24	TC.. 1102..	0,400		
212324900	212325000	A25R STFC R/L 16	25	23	11,5	200	40	17	31	TC.. 16T3..	0,700		
212325100	212325200	A32S STFC R/L 16	32	30	15,0	250	50	22	39	TC.. 16T3..	1,400		
212325300	212325400	A40T STFC R/L 16	40	37	18,5	300	60	27	48	TC.. 16T3..	2,650		

 Stock Items | Itens de stock

 Available under request | Disponível sob consulta | Disponible bajo consulta

SPARE PARTS | Complementos | Repuestos





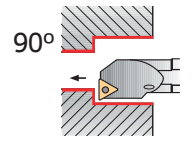

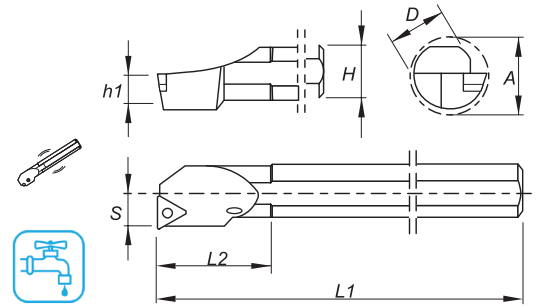

Cutter Reference	Shim	Shim Screw	Screw	Wrench
A10H STFC R/L 09				
A12K STFC R/L 11	-	-	P0220600	XT06
A16M STFC R/L 11	-	-	P0250700	XT07
A20Q STFC R/L 11	-	-	P0250700	XT07
A25R STFC R/L 16	-	-	P0401100	XT15-S35
A32S STFC R/L 16	CT160302	T05003500	P0351500	XT15-S35
A40T STFC R/L 16	CT160302	T05003500	P0351500	XT15-S35





(S) CENTER SCREW TOOLHOLDERS



Axial: 0°
Radial: -6°





Finishing	Finishing	Finishing	Finishing
Flat	FP	FM	FK
 (09-11)	 (09-11)	 (09-11)	 (09-11)
Medium	Medium	Medium	Medium to Finishing
MP	MM	MK	LN
 (09-11)	 (09-11)	 (09-11)	 (11)

Order Code		Reference	Dimensions (mm)							Insert	Kg	Stock	
R	L		D	H	h1	L1	L2	S	A			R	L
212326200	212326300	E12Q STFC R/L 11	12	11	5,5	180	25	9	16	TC.. 1102..	0,250		
212326400	212326500	E16R STFC R/L 11	16	15	7,5	200	30	11	20	TC.. 1102..	0,600		











 Stock Items | Itens de stock

 Available under request | Disponível sob consulta | Disponible bajo consulta









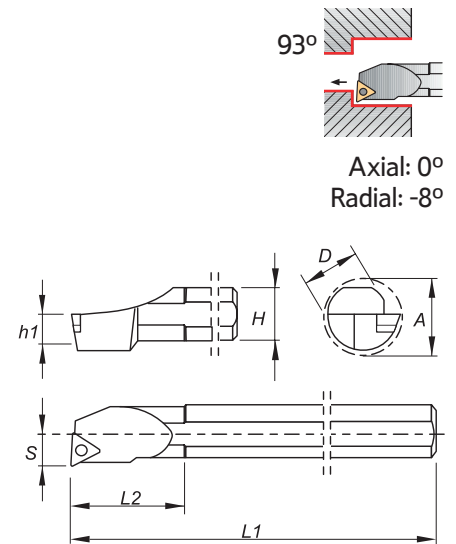

SPARE PARTS || Complementos | Repuestos

Cutter Reference	Screw	Wrench
E12M STFC R/L 11	 P0250700	 XT07
E16R STFC R/L 11	P0400802	XT15-S35

(S) CENTER SCREW TOOLHOLDERS

Finishing	Finishing	Finishing	Finishing	Finishing wiper
Flat  (11-16)	FP  (11-16)	FM  (11-16)	FK  (11-16)	FW  (11-16)
Medium	Medium	Medium	Medium to Finishing wiper	Medium to Finishing
MP  (11-16)	MM  (11-16)	MK  (11-16)	MW  (11-16)	LN  (11-16)







Order Code		Reference	Dimensions (mm)							Insert	Kg	Stock	
R	L		D	H	h1	L1	L2	S	A			R	L
212029100	212029200	S12M STUC R/L 11	12	11	5,5	150	25	9	16	TC.. 1102..	0,150		
212029300	212029400	S16R STUC R/L 16	16	15	7,5	200	30	11	20	TC.. 16T3..	0,300		
212036900	212029500	S20S STUC R/L 16	20	18	9,0	250	35	13	24	TC.. 16T3..	0,550		
212029600	212029700	S25T STUC R/L 16	25	23	11,5	300	40	17	31	TC.. 16T3..	0,700		
212160800	212044600	S32U STUC R/L 16	32	30	15,0	350	50	22	39	TC.. 16T3..	2,050		

 Stock Items | Itens de stock

 Available under request | Disponível sob consulta | Disponible bajo consulta

SPARE PARTS | Complementos | Repuestos







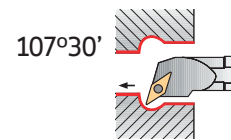

Cutter Reference	Shim	Shim Screw	Screw	Wrench
S12M STUC R/L 11				
S16R STUC R/L 16	-	-	P0401100	XT15-S35
S20S STUC R/L 16	-	-	P0401100	XT15-S35
S25T STUC R/L 16	-	-	P0401100	XT15-S35
S32U STUC R/L 16	CT160302	T05003500	P0351500	XT15-S35

C
TURNING
Insert selection
Overview
Negative inserts
Positive inserts
PCBN & PCD inserts
Heavy turning
External Toolholders
Internal Toolholders
Automatic Lathes
Spare Parts
Technical Data









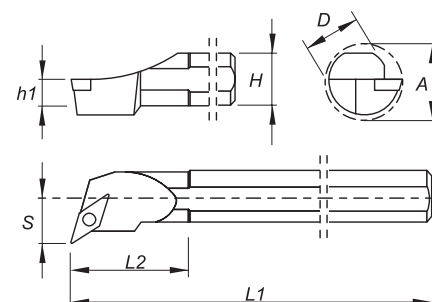

(S) CENTER SCREW TOOLHOLDERS



Axial: 0°
Radial: -6°

Finishing	Finishing	Finishing	Finishing
Flat	FP	FM	FK
			
(11-16)	(11-16)	(11-16)	(11-16)
Medium	Medium	Medium	Medium to Finishing
MP	MM	MK	LN
			
(11-16)	(11-16)	(11-16)	(11-16)







Order Code		Reference	Dimensions (mm)							Insert	Kg	Stock	
R	L		D	H	h1	L1	L2	S	A			R	L
212165000	212165100	S16R SVQC R/L 11	16	15	7,5	200	30	11	20	VC.. 1103..	0,300		
212165200	212165300	S20S SVQC R/L 11	20	18	9,0	250	35	13	24	VC.. 1103..	0,550		
212165500	212165400	S16R SVQC R/L 13	16	15	7,5	200	30	13	22	VC.. 1103..	0,300		
212165700	212165600	S20S SVQC R/L 13	20	18	9,0	250	35	13	24	VC.. 1103..	0,550		
212165900	212165800	S25T SVQC R/L 16	25	23	11,5	300	40	17	31	VC.. 1604..	0,700		







 Stock Items | Itens de stock

 Available under request | Disponível sob consulta | Disponible bajo consulta

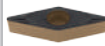
SPARE PARTS || Complementos | Repuestos

Cutter Reference	Shim	Shim Screw	Screw	Wrench
S16R SVQC R/L 11				
S20S SVQC R/L 11	-	-	P0250700	XT07
S16R SVQC R/L 13	-	-	P0300900	XT08
S20S SVQC R/L 13	-	-	P0300900	XT08
S25T SVQC R/L 16	CV160300	T05003500	P0351500	XT15-S35





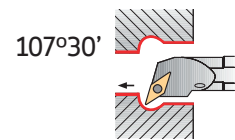



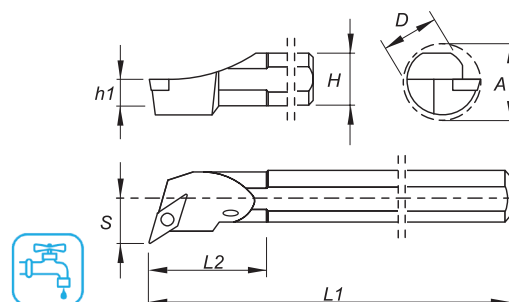

(S) CENTER SCREW TOOLHOLDERS

Finishing	Finishing	Finishing	Finishing
Flat	FP	FM	FK
			
(11-16)	(11-16)	(11-16)	(11-16)
Medium	Medium	Medium	Medium to Finishing
MP	MM	MK	LN
			
(11-16)	(11-16)	(11-16)	(11-16)



Axial: 0°
Radial: -6°







Order Code		Reference	Dimensions (mm)							Insert	Kg	Stock	
R	L		D	H	h1	L1	L2	S	A			R	L
212326600	212326700	A16M SVQC R/L 11	16	15	7,5	150	30	11	20	VC.. 1103..	0,200		
212326800	212326900	A20Q SVQC R/L 11	20	18	9,0	180	35	13	24	VC.. 1103..	0,400		
212327000	212327100	A25R SVQC R/L 16	25	23	11,5	200	40	17	31	VC.. 1604..	0,700		
212327200	212327300	A32S SVQC R/L 16	32	30	15,0	250	50	22	39	VC.. 1604..	1,400		
212327400	212327500	A40T SVQC R/L 16	40	37	18,5	300	60	27	48	VC.. 1604..	2,650		

 Stock Items | Itens de stock





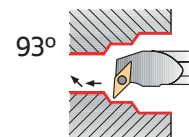

 Available under request | Disponível sob consulta | Disponible bajo consulta

SPARE PARTS || Complementos | Repuestos





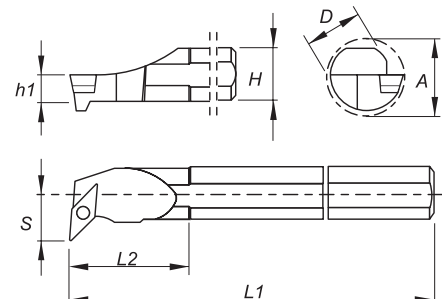

Cutter Reference	Shim	Shim Screw	Screw	Wrench
A16M SVQC R/L 11				
A20Q SVQC R/L 11	-	-	P0250700	XT07
A25R SVQC R/L 16	CV160300	T05003500	P0351500	XT15-S35
A32S SVQC R/L 16	CV160300	T05003500	P0351500	XT15-S35
A40T SVQC R/L 16	CV160300	T05003500	P0351500	XT15-S35

(S) CENTER SCREW TOOLHOLDERS



Finishing	Finishing	Finishing	Finishing
Flat	FP	FM	FK
			
(16)	(16)	(16)	(16)
Medium	Medium	Medium	
MP	MM	MK	
			
(16)	(16)	(16)	







Order Code		Reference	Dimensions (mm)							Insert	Kg	Stock	
R	L		D	H	h1	L1	L2	S	A			R	L
212056200	212327600	S25T SVUB R/L 16	25	23	11,5	300	40	17	31	VB.. 1604..	0,700		
212327700	212327800	S32U SVUB R/L 16	32	30	15,0	350	50	22	39	VB.. 1604..	2,050		
212327900	212328000	S40V SVUB R/L 16	40	37	18,5	400	60	27	48	VB.. 1604..	3,750		







 Stock Items | Itens de stock

 Available under request | Disponivel sob consulta | Disponible bajo consulta

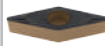







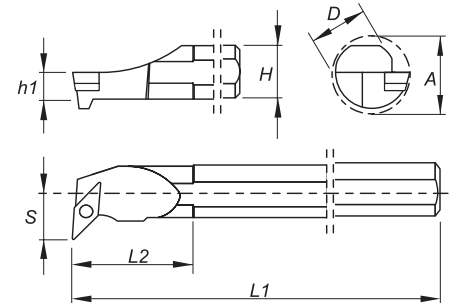
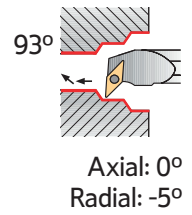

SPARE PARTS | Complementos | Repuestos

Cutter Reference	Shim	Shim Screw	Screw	Wrench
S25T SVUB R/L 16				
S32U SVUB R/L 16	CV160300	T05003500	P0351500	XT15-S35
S40V SVUB R/L 16	CV160300	T05003500	P0351500	XT15-S35

(S) CENTER SCREW TOOLHOLDERS

Finishing	Finishing	Finishing	Finishing
Flat	FP	FM	FK
			
(11-16)	(11-16)	(11-16)	(11-16)
Medium	Medium	Medium	Medium to Finishing
MP	MM	MK	LN
			
(11-16)	(11-16)	(11-16)	(11-16)







Order Code		Reference	Dimensions (mm)							Insert	Kg	Stock	
R	L		D	H	h1	L1	L2	S	A			R	L
212166000	212166100	S16R SVUC R/L 11	16	15	7,5	200	30	11	20	VC.. 1103..	0,300		
212166200	212166300	S20S SVUC R/L 11	20	18	9,0	250	35	13	24	VC.. 1103..	0,550		
212328100	212166400	S25T SVUC R/L 16	25	23	11,5	300	40	17	31	VC.. 1604..	0,700		
212328200	212166500	S32U SVUC R/L 16	32	30	15,0	350	50	22	39	VC.. 1604..	2,050		
212166700	212166600	S40V SVUC R/L 16	40	37	18,5	400	60	27	48	VC.. 1604..	3,750		









 Stock Items | Itens de stock

 Available under request | Disponível sob consulta | Disponible bajo consulta

SPARE PARTS || Complementos | Repuestos

Cutter Reference	Shim	Shim Screw	Screw	Wrench
S16R SVUC R/L 11				
S20S SVUC R/L 11	-	-	P0250700	XT07
S25T SVUC R/L 16	CV160300	T05003500	P0351500	XT15-S35
S32U SVUC R/L 16	CV160300	T05003500	P0351500	XT15-S35
S40V SVUC R/L 16	CV160300	T05003500	P0351500	XT15-S35





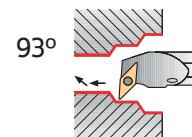



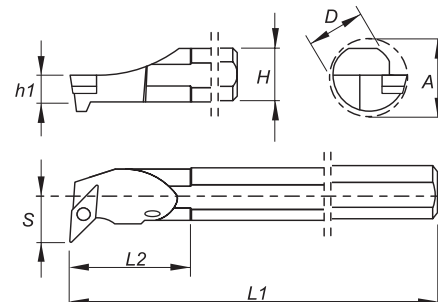

(S) CENTER SCREW TOOLHOLDERS

Finishing	Finishing	Finishing	Finishing
Flat	FP	FM	FK
			
(11-16)	(11-16)	(11-16)	(11-16)
Medium	Medium	Medium	Medium to Finishing
MP	MM	MK	LN
			
(11-16)	(11-16)	(11-16)	(11-16)



Axial: 0°
Radial: -5°







Order Code		Reference	Dimensions (mm)							Insert	Kg	Stock	
R	L		D	H	h1	L1	L2	S	A			R	L
212328300	212328400	A16M SVUC R/L 11	16	15	7,5	150	30	11	20	VC.. 1103..	0,200		
212328500	212328600	A20Q SVUC R/L 11	20	18	9,0	180	35	13	24	VC.. 1103..	0,400		
212328700	212328800	A25R SVUC R/L 16	25	23	11,5	200	40	17	31	VC.. 1604..	0,700		
212328900	212329000	A32S SVUC R/L 16	32	30	15,0	250	50	22	39	VC.. 1604..	1,400		
212329100	212329200	A40T SVUC R/L 16	40	37	18,5	300	60	27	48	VC.. 1604..	2,650		









 Stock items | Itens de stock

 Available under request | Disponível sob consulta | Disponible bajo consulta





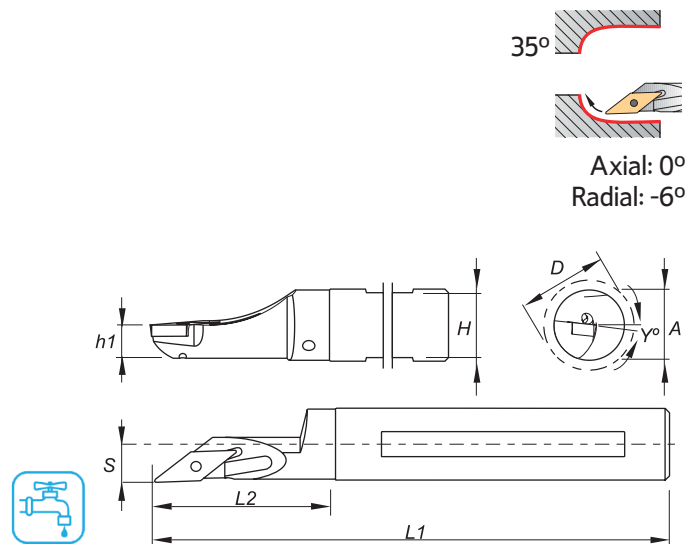

SPARE PARTS | Complementos | Repuestos

Cutter Reference	Shim	Shim Screw	Screw	Wrench
A16M SVUC R/L 11				
A20Q SVUC R/L 11	-	-	P0250700	XT07
A25R SVUC R/L 16	CV160300	T05003500	P0351500	XT15-S35
A32S SVUC R/L 16	CV160300	T05003500	P0351500	XT15-S35
A40T SVUC R/L 16	CV160300	T05003500	P0351500	XT15-S35

(S) CENTER SCREW TOOLHOLDERS

Finishing	Finishing	Finishing	Finishing
Flat	FP	FM	FK
			
(11-16)	(11-16)	(11-16)	(11-16)
Medium	Medium	Medium	Medium to Finishing
MP	MM	MK	LN
			
(11-16)	(11-16)	(11-16)	(11-16)





Order Code		Reference	Dimensions (mm)								Insert	Kg	Stock	
R	L		D	H	h1	L1	L2	S	Y°	A			R	L
212362400	212362500	A16M SVJC R/L 11	16	15	7,5	150	22	2	6	22	VC.. 1103..	0,200		
212362600	212362700	A20Q SVJC R/L 11	20	18	9,0	180	25	2	5	25	VC.. 1103..	0,300		
212362800	212362900	A25R SVJC R/L 16	25	23	11,5	200	28	2	4	28	VC.. 1604..	0,650		

 Stock Items | Itens de stock

 Available under request | Disponível sob consulta | Disponible bajo consulta

SPARE PARTS || Complementos | Repuestos

Cutter Reference	Screw	Wrench
		
A16M SVJC R/L 11	P0250700	XT07
A20Q SVJC R/L 11	P0250700	XT07
A25R SVJC R/L 16	P0401100	XT15-S35

TURNING
Insert selection
Overview
Negative inserts
Positive inserts
PCBN & PCD inserts
Heavy turning
External Toolholders
Internal Toolholders
Automatic Lathes
Spare Parts
Technical Data

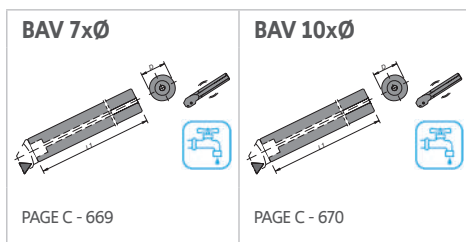

(D) DIMPLE LOCK ANTI VIBRATION FOR INTERNAL TURNING

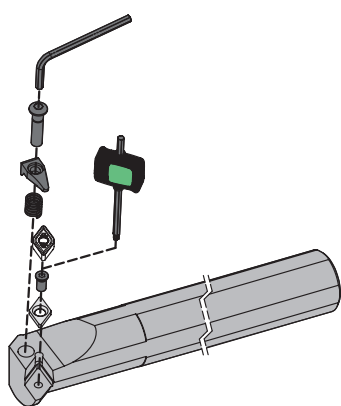

(S) CENTER SCREW ANTI VIBRATION FOR INTERNAL TURNING

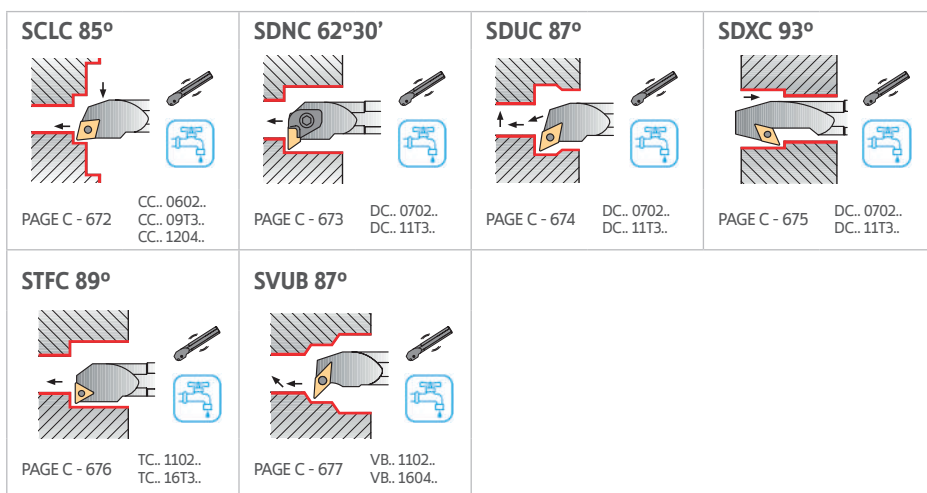
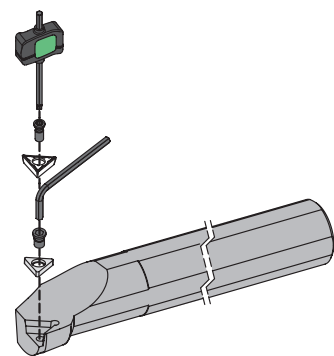

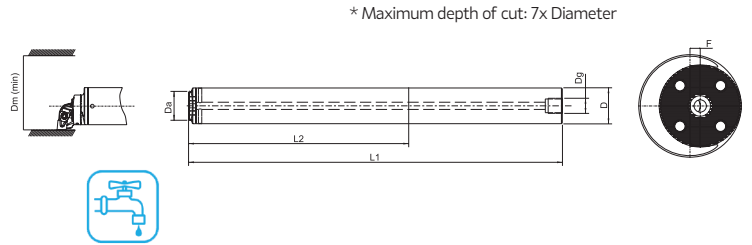

Order Code	Reference	Dimensions (mm)							Stock
		ØD	ØDa	Dm(min)	F	L1	L2	ØDg	
212454800	AVB16-16-7D	16	16	20	-	156	100	G1/8"	⊗
212454900	AVB20-20-7D	20	20	25	-	200	125	G1/4"	⊗
212455000	AVB25-25-7D	25	25	32	-	255	155	G1/4"	⊗
212455100	AVB32-32-7D	32	32	40	-	320	190	G3/8"	⊗
212455200	AVB40-40-7D	40	40	50	-	408	240	G1/2"	○
212455300	AVB50-40-7D	50	40	60	5	518	305	G1/2"	○
212455400	AVB60-40-7D	60	40	72	10	628	380	G3/4"	○

⊗ Stock Items | Itens de stock

○ Available under request | Disponível sob consulta | Disponible bajo consulta

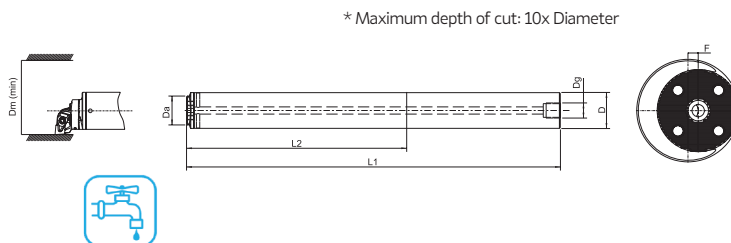

Order Code	Reference	Dimensions (mm)							Stock
		ØD	ØDa	ØDm(min)	F	L1	L2	ØDg	
212455500	AVB25-25-10D	25	25	32	-	330	255	G1/4"	⊗
212455600	AVB32-32-10D	32	32	40	-	416	320	G3/8"	⊗
212455700	AVB40-40-10D	40	40	50	-	528	410	G1/2"	○
212455800	AVB50-40-10D	50	40	60	5	668	520	G1/2"	○
212455900	AVB60-40-10D	60	40	72	10	808	630	G3/4"	○

⊗ Stock Items | Itens de stock

○ Available under request | Disponível sob consulta | Disponible bajo consulta

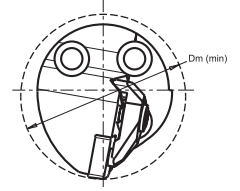
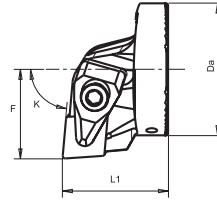

L	R	Reference	Dimensions (mm)						Stock	
			ØDa	ØDm	F	L1	L2	Insert	L	R
212459100	212456000	AVH32 DCLN R/L-12	32	40	22	38	-	CN.. 1204	○	⊗
212459200	212456100	AVH40 DCLN R/L-12	40	50	27	38	-	CN.. 1204	○	○

⊗ Stock Items | Itens de stock

○ Available under request | Disponível sob consulta | Disponible bajo consulta

SPARE PARTS || Complementos | Repuestos

Spring	Clamp	Clamp Screw	Wrench
			
M09513	GA07002	D0602900	XT15-S35
M09513	GA07002	D0602900	XT15-S35

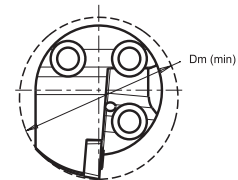
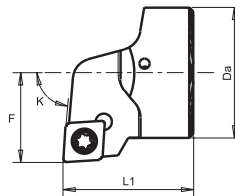





L	R	Reference	Dimensions (mm)						Stock	
			ØDa	ØDm	F	L1	L2	Insert	L	R
212459300	212456100	AVH16 SCLC R/L-06	16	20	11	20	-	CC.. 0602	⊗	⊗
212459400	212456200	AVH20 SCLC R/L-09	20	25	13	20	-	CC.. 09T3	⊗	⊗
212459500	212456300	AVH25 SCLC R/L-09	25	32	17	20	-	CC.. 09T3	⊗	⊗
212459600	212456400	AVH32 SCLC R/L-09	32	40	22	32	-	CC.. 09T3	⊗	⊗
212459700	212456500	AVH40 SCLC R/L-12	40	50	27	38	-	CC.. 1204	○	○

⊗ Stock items | Itens de stock

○ Available under request | Disponível sob consulta | Disponible bajo consulta

SPARE PARTS || Complementos | Repuestos

Reference	Shim	Shim Screw	Screw	Wrench
AVH16 SCLC R/L-06				
AVH16 SCLC R/L-06	-	-	P0250700	XT07
AVH20 SCLC R/L-09	-	-	P0401100	XT15-S35
AVH25 SCLC R/L-09	-	-	P0401100	XT15-S35
AVH32 SCLC R/L-09	-	-	P0401100	XT15-S35
AVH40 SCLC R/L-12	CC120401	T06004000	P0401400	XT15-S40

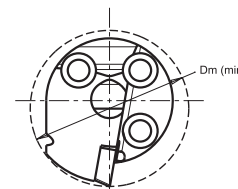
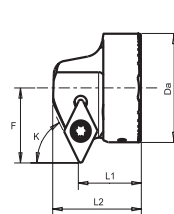





L	R	Reference	Dimensions (mm)						Stock	
			ØDa	ØDm	F	L1	L2	Insert	L	R
212460800	212457700	AVH16 SDNC R/L-07	16	22	13	15	19,5	DC.. 0702	⊗	○
212460900	212457800	AVH20 SDNC R/L-07	20	27	15	15	19,5	DC.. 0702	⊗	○
212461000	212457900	AVH25 SDNC R/L-07	25	33	18	15	19,5	DC.. 0702	⊗	○
212461100	212458000	AVH32 SDNC R/L-11	32	40	22	20	28	DC.. 11T3	○	○
212461200	212458100	AVH40 SDNC R/L-11	40	50	27	20	28	DC.. 11T3	○	○

⊗ Stock Items | Itens de stock

○ Available under request | Disponível sob consulta | Disponible bajo consulta

SPARE PARTS || Complementos | Repuestos

Reference	Shim	Shim Screw	Screw	Wrench
AVH16 SDNC R/L-07				
AVH16 SDNC R/L-07	-	-	P0250700	XT07
AVH20 SDNC R/L-07	-	-	P0250700	XT07
AVH25 SDNC R/L-11	-	-	P0401100	XT15-S35
AVH32 SDNC R/L-11	CD110301	T05003500	P0351500	XT15-S35
AVH40 SDNC R/L-11	CD110301	T05003500	P0351500	XT15-S35

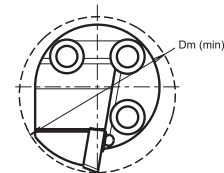
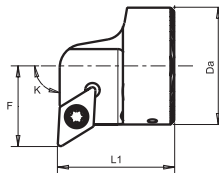

L	R	Reference	Dimensions (mm)						Stock	
			ØDa	ØDm	F	L1	L2	Insert	L	R
212459800	212456700	AVH16 SDUC R/L-07	16	20	11	20	-	DC.. 0702		
212459900	212456800	AVH20 SDUC R/L-07	20	25	13	20	-	DC.. 0702		
212460000	212456900	AVH25 SDUC R/L-11	25	32	17	20	-	DC.. 11T3		
212460100	212457000	AVH32 SDUC R/L-11	32	40	22	32	-	DC.. 11T3		
212460200	212457100	AVH40 SDUC R/L-11	40	50	27	32	-	DC.. 11T3		

Stock Items | Itens de stock

Available under request | Disponível sob consulta | Disponible bajo consulta

SPARE PARTS || Complementos | Repuestos

Reference	Shim	Shim Screw	Screw	Wrench
AVH16 SDUC R/L-07				
AVH16 SDUC R/L-07	-	-	P0250700	XT07
AVH20 SDUC R/L-07	-	-	P0250700	XT07
AVH25 SDUC R/L-11	-	-	P0401100	XT15-S35
AVH32 SDUC R/L-11	CD110301	T05003500	P0351500	XT15-S35
AVH40 SDUC R/L-11	CD110301	T05003500	P0351500	XT15-S35

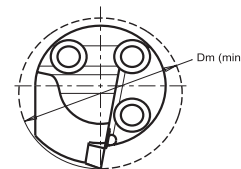
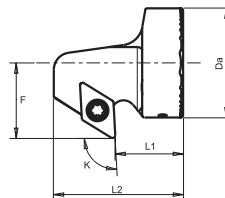

L	R	Reference	Dimensions (mm)						Stock	
			ØDa	ØDm	F	L1	L2	Insert	L	R
212460300	212457200	AVH16 SDXC R/L-07	16	22	13	15	26,5	DC.. 0702		
212460400	212457300	AVH20 SDXC R/L-07	20	27	15	15	26,5	DC.. 0702		
212460500	212457400	AVH25 SDXC R/L-07	25	33	18	15	26,5	DC.. 0702		
212460600	212457500	AVH32 SDXC R/L-11	32	40	22	20	38	DC.. 11T3		
212460700	212457600	AVH40 SDXC R/L-11	40	50	27	20	38	DC.. 11T3		

Stock items | Itens de stock

Available under request | Disponível sob consulta | Disponible bajo consulta

SPARE PARTS || Complementos | Repuestos

Reference	Shim	Shim Screw	Screw	Wrench
AVH16 SDXC R/L-07				
AVH16 SDXC R/L-07	-	-	P0250700	XT07
AVH20 SDXC R/L-07	-	-	P0250700	XT07
AVH25 SDXC R/L-11	-	-	P0401100	XT15-S35
AVH32 SDXC R/L-11	CD110301	T05003500	P0351500	XT15-S35
AVH40 SDXC R/L-11	CD110301	T05003500	P0351500	XT15-S35

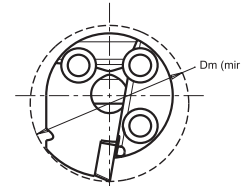
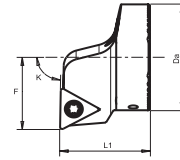

L	R	Reference	Dimensions (mm)						Stock	
			ØDa	ØDm	F	L1	L2	Insert	L	R
212461700	212458600	AVH16 STFC R/L-11	16	20	11	20	-	TC.. 1102	○	⊗
212461800	212458700	AVH20 STFC R/L-11	20	25	13	20	-	TC.. 1102	○	⊗
212461900	212458800	AVH25 STFC R/L-11	25	32	17	20	-	TC.. 1102	○	⊗
212462000	212458900	AVH32 STFC R/L-16	32	40	22	32	-	TC.. 16T3	○	○
212462100	212459000	AVH40 STFC R/L-16	40	50	27	32	-	TC.. 16T3	○	○

⊗ Stock Items | Itens de stock

○ Available under request | Disponível sob consulta | Disponible bajo consulta

SPARE PARTS || Complementos | Repuestos

Reference	Shim	Shim Screw	Screw	Wrench
AVH16 STFC R/L-11	-	-	-	XT07
AVH20 STFC R/L-11	-	-	-	XT07
AVH25 STFC R/L-16	-	-	P0401100	XT15-S35
AVH32 STFC R/L-16	CT160302	T05003500	P0351500	XT15-S35
AVH40 STFC R/L-16	CT160302	T05003500	P0351500	XT15-S35

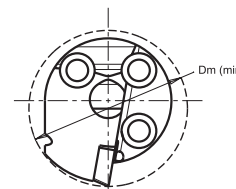
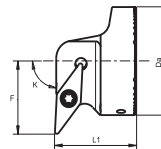

L	R	Reference	Dimensions (mm)						Stock	
			ØDa	ØDm	F	L1	L2	Insert	L	R
212461300	212458200	AVH20 SVUB R/L-11	20	27	16	20	-	VB.. 1102	○	⊗
212461400	212458300	AVH25 SVUB R/L-11	25	31	17	25	-	VB.. 1102	○	⊗
212461500	212458400	AVH32 SVUB R/L-16	32	40	22	32	-	VB.. 1604	○	⊗
212461600	212458500	AVH40 SVUB R/L-16	40	50	27	32	-	VB.. 1604	○	○

⊗ Stock Items | Itens de stock

○ Available under request | Disponível sob consulta | Disponible bajo consulta

SPARE PARTS || Complementos | Repuestos

Reference	Shim	Shim Screw	Screw	Wrench
AVH20 SVUB R/L-11	-	-	P0250700	XT07
AVH25 SVUB R/L-11	-	-	P0250700	XT07
AVH32 SVUB R/L-16	CV160300	T05003500	P0351500	XT15-S35
AVH40 SVUB R/L-16	CV160300	T05003500	P0351500	XT15-S35

Tooling solutions for Wind Energy Industry



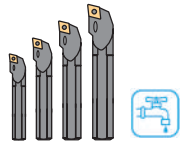
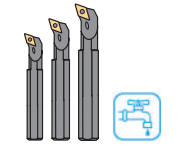
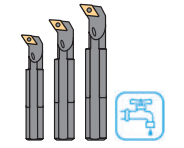
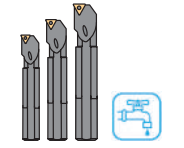











<p>PK SCLC 95°</p>  <p>PAGE C - 680 CC.. 0602..</p>	<p>PK SDQC 107°30'</p>  <p>PAGE C - 681 DC.. 0702..</p>	<p>PK SDUC 93°</p>  <p>PAGE C - 682 DC.. 0702..</p>	<p>PK STFC 90°</p>  <p>PAGE C - 683 TC.. 1102..</p>
---	---	---	--









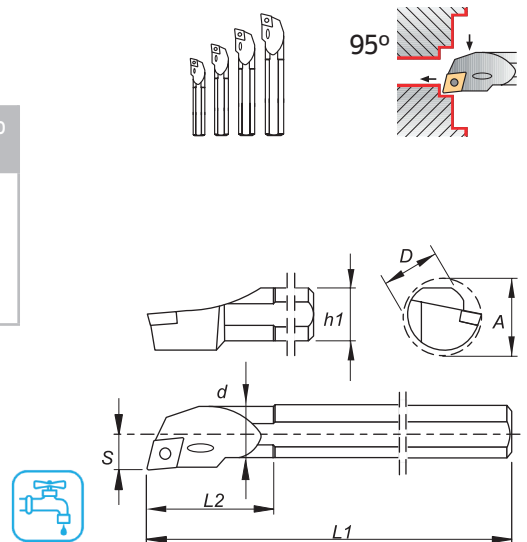



INTERNAL TOOLHOLDERS SET

Conjuntos de ferramentas de torneamento interno | Grupos de herramientas de torneado interno

Finishing	Finishing	Finishing	Finishing	Finishing	Finishing wiper	Medium to Finishing
Flat  (06)	FP  (06)	BO  (06)	FM  (06)	FK  (06)	FW  (06)	LM  (06)
Medium	Medium	Medium	Medium to Finishing wiper	Finishing to Fine finishing	Medium to Finishing	
MP  (06)	MM  (06)	MK  (06)	MW  (06)	FS  (06)	LN  (06)	





Order Code		Reference	Dimensions (mm)							Insert	Kg	Stock	
R Pack	R		D	d	L1	L2	S	A	h1			Pack	R
212359300	212250500	A0608H SCLC R 06	8	6	100	25	4	10	7	CC.. 0602..	0,400		
	212359400	A0810J SCLC R 06	10	8	110	32	6	12	9	CC.. 0602..			
	212250600	A1012K SCLC R 06	12	10	125	38	7	14	11	CC.. 0602..			
	212167900	A1216M SCLC R 06	16	12	150	50	9	18	15	CC.. 0602..			

Order Code		Reference	Dimensions (mm)							Insert	Kg	Stock	
L Pack	L		D	d	L1	L2	S	A	L1			Pack	L
212359500	212359600	A0608H SCLC L 06	8	6	100	25	4	10	7	CC.. 0602..	0,400		
	212359700	A0810J SCLC L 06	10	8	110	32	6	12	9	CC.. 0602..			
	212359800	A1012K SCLC L 06	12	10	125	38	7	14	11	CC.. 0602..			
	212359900	A1216M SCLC L 06	16	12	150	50	9	18	15	CC.. 0602..			

 Stock Items | Itens de stock

 Available under request | Disponível sob consulta | Disponible bajo consulta







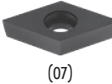
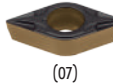

SPARE PARTS || Complementos | Repuestos

Cutter Reference	Screw	Wrench
A0608H SCLC R/L 06	 P0200601	 XT07
A0810J SCLC R/L 06	P0200601	XT07
A1012K SCLC R/L 06	P0250700	XT07
A1216M SCLC R/L 06	P0250700	XT07

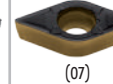
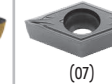



PK SDQC 107°30' || TOOLHOLDERS | Ferros de torno | Herramientas de torneado



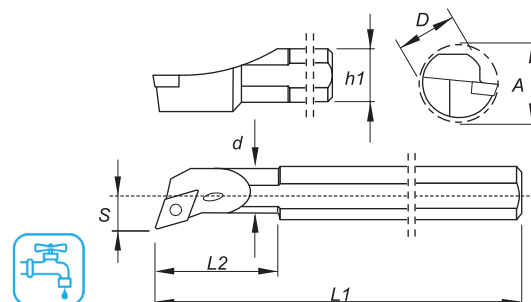
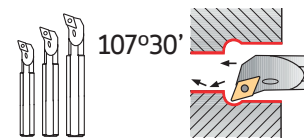

INTERNAL TOOLHOLDERS SET

Conjuntos de ferramentas de torneamento interno | Grupos de herramientas de torneado interno

Finishing	Finishing	Finishing	Finishing	Finishing wiper	Medium to Finishing
Flat	FP	FM	FK	FW	LM
 (07)	 (07)	 (07)	 (07)	 (07)	 (07)
Medium	Medium	Medium	Finishing to Fine Finishing	Finishing to Fine Finishing	
MP	MM	MK	FS	LN	
 (07)	 (07)	 (07)	 (07)	 (07)	



Order Code		Reference	Dimensions (mm)							Insert	Kg	Stock	
R Pack	R		D	d	L1	L2	S	A	h1			Pack	R
212360000	212360100	A0810J SDQC R 07	10	8	110	32	7	12,5	9	DC.. 0702..	0,350		
	212360200	A1012K SDQC R 07	12	10	125	38	9	15,5	11	DC.. 0702..			
	212360300	A1216M SDQC R 07	16	12	150	50	11	19,5	15	DC.. 0702..			

Order Code		Reference	Dimensions (mm)							Insert	Kg	Stock	
L Pack	L		D	d	L1	L2	S	A	L1			Pack	L
212360400	212360500	A0810J SDQC L 07	10	8	110	32	7	12,5	9	DC.. 0702..	0,350		
	212360600	A1012K SDQC L 07	12	10	125	38	9	15,5	11	DC.. 0702..			
	212360700	A1216M SDQC L 07	16	12	150	50	11	19,5	15	DC.. 0702..			

 Stock Items | Itens de stock

 Available under request | Disponível sob consulta | Disponible bajo consulta







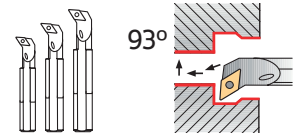

SPARE PARTS || Complementos | Repuestos

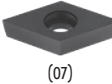
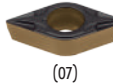
Cutter Reference	Screw	Wrench
		
A0810J SDQC R/L 07	P0200601	XT07
A1012K SDQC R/L 07	P0250700	XT07
A1216M SDQC R/L 07	P0250700	XT07

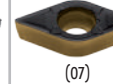
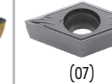



INTERNAL TOOLHOLDERS SET



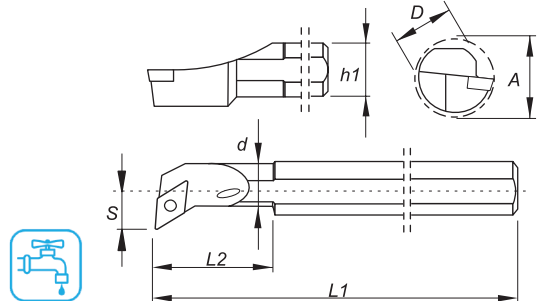

Conjuntos de ferramentas de torneamento interno | Grupos de herramientas de torneado interno



Finishing	Finishing	Finishing	Finishing	Finishing wiper	Medium to Finishing
Flat	FP	FM	FK	FW	LM
 (07)	 (07)	 (07)	 (07)	 (07)	 (07)
Medium	Medium	Medium	Finishing to Fine Finishing	Finishing to Fine Finishing	
MP	MM	MK	FS	LN	
 (07)	 (07)	 (07)	 (07)	 (07)	



Order Code		Reference	Dimensions (mm)							Insert	Kg	Stock	
R Pack	R		D	d	L1	L2	S	A	h1			Pack	R
212360800	212360900	A0810J SDUC R 07	10	8	110	32	7	12,5	9	DC.. 0702..	0,350		
	212361000	A1012K SDUC R 07	12	10	125	38	9	15,5	11	DC.. 0702..			
	212361100	A1216M SDUC R 07	16	12	150	50	11	19,5	15	DC.. 0702..			

Order Code		Reference	Dimensions (mm)							Insert	Kg	Stock	
L Pack	L		D	d	L1	L2	S	A	L1			Pack	L
212361200	212361300	A0810J SDUC L 07	10	8	110	32	7	12,5	9	DC.. 0702..	0,350		
	212361400	A1012K SDUC L 07	12	10	125	38	9	15,5	11	DC.. 0702..			
	212361500	A1216M SDUC L 07	16	12	150	50	11	19,5	15	DC.. 0702..			

 Stock Items | Itens de stock







 Available under request | Disponível sob consulta | Disponible bajo consulta

SPARE PARTS || Complementos | Repuestos





Cutter Reference	Screw	Wrench
		
A0810J SDUC R/L 07	P0200601	XT07
A1012K SDUC R/L 07	P0250700	XT07
A1216M SDUC R/L 07	P0250700	XT07



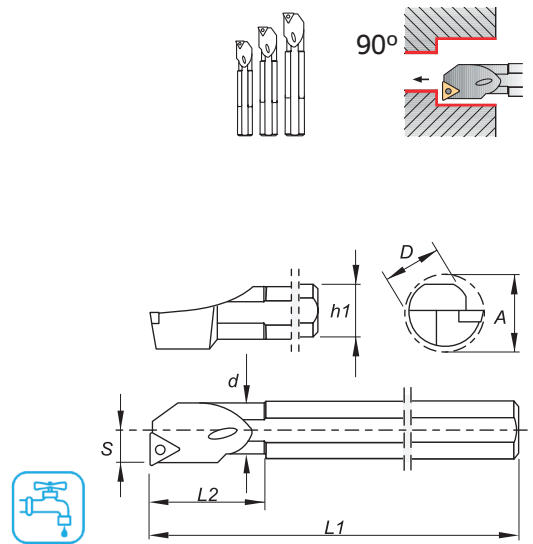

INTERNAL TOOLHOLDERS SET

Conjuntos de herramientas de torneamento interno | Grupos de herramientas de torneado interno

Finishing	Finishing	Finishing	Finishing
Flat	FP	FM	FK
 (11)	 (11)	 (11)	 (11)
Medium	Medium	Medium	Medium to Finishing
MP	MM	MK	LN
 (11)	 (11)	 (11)	 (11)





Order Code		Reference	Dimensions (mm)							Insert	Kg	Stock	
R Pack	R		D	d	L1	L2	S	A	h1			Pack	R
212361600	212361700	A0810J STFC R 11	10	8	110	32	7	12,5	9	TC.. 1102..	0,350		
	212361800	A1012K STFC R 11	12	10	125	38	9	15,5	11	TC.. 1102..			
	212361900	A1216M STFC R 11	16	12	150	50	11	19,5	15	TC.. 1102..			

Order Code		Reference	Dimensions (mm)							Insert	Kg	Stock	
L Pack	L		D	d	L1	L2	S	A	L1			Pack	L
212362000	212362100	A0810J STFC L 11	10	8	110	32	7	12,5	9	TC.. 1102..	0,350		
	212362200	A1012K STFC L 11	12	10	125	38	9	15,5	11	TC.. 1102..			
	212362300	A1216M STFC L 11	16	12	150	50	11	19,5	15	TC.. 1102..			

 Stock Items | Itens de stock

 Available under request | Disponível sob consulta | Disponible bajo consulta

SPARE PARTS || Complementos | Repuestos

Cutter Reference	Screw	Wrench
		
A0810J STFC R/L 11	P0200601	XT07
A1012K STFC R/L 11	P0250700	XT07
A1216M STFC R/L 11	P0250700	XT07

CODE KEY FOR AUTOMATIC LATHES (ISO)

Sistema De Codificação Para Tornos Automáticos (Iso) | Codificación De Herramientas De Tornos Automáticos (Iso)

S	C	A	C	R	12	12	M	09
1	2	3	4	5	6	7	8	9

1 - Inserts Clamping System

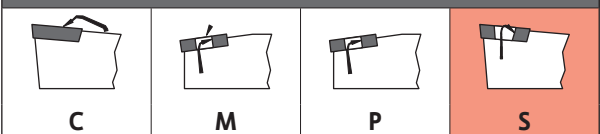

2 - Insert Shape

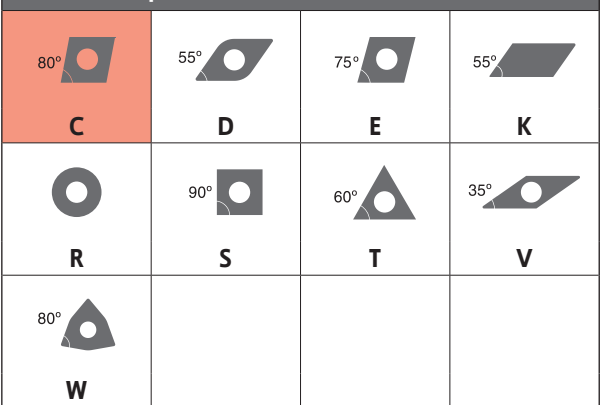

4 - Inserts Clearance Angle

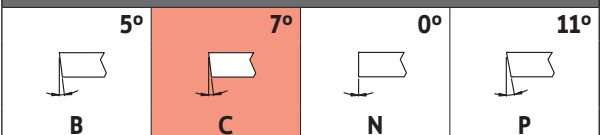

5 - Tool Hand

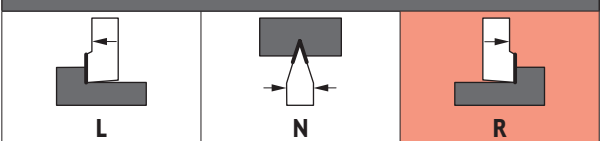

8 - Length of Holder (mm)

	D	60	P	170
	E	70	R	200
	F	80	S	250
	H	100	T	300
	K	125	U	350
	L	140	V	400
	M	150	X	Special

3 - Toolholder Leading Angle

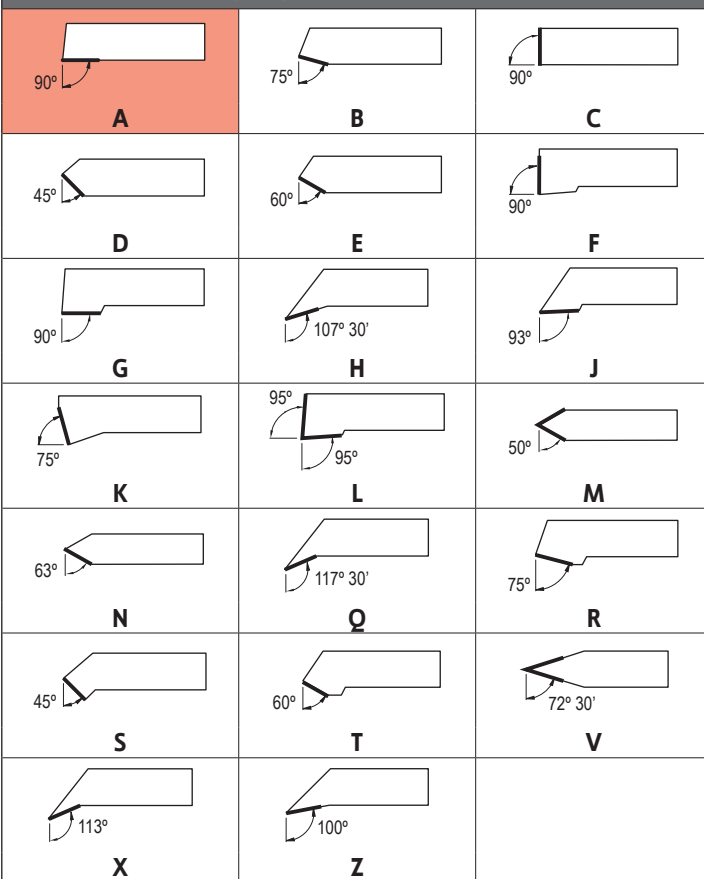

6 - Height of Shank (mm)

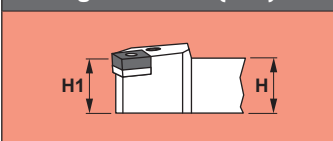

7 - Width of Shank (mm)

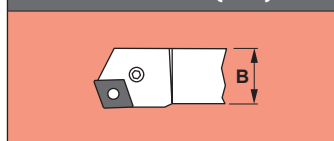

9 - Length of Inserts Cutting Edge (mm)

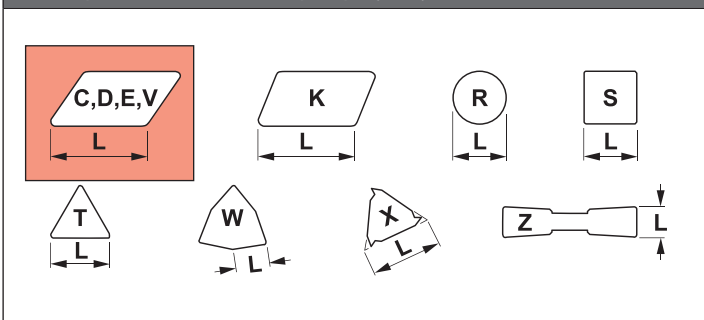



C - 608 | Code Key

C - 610 | Overview

C - 611 | Center Screw Toolholders (S)

AUTOMATIC LATHES



TURNING

Insert selection

Overview

Negative inserts

Positive inserts

PCBN & PCD inserts

Heavy turning

External Toolholders

Internal Toolholders

Automatic Lathes

Spare Parts

Technical Data

CENTER SCREW TOOLHOLDERS

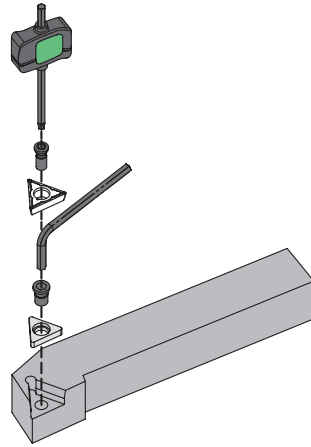

<p>SCAC 90°</p> <p>PAGE C - 687 CC.. 0602.. CC.. 09T3..</p>	<p>SCLC 95°</p> <p>PAGE C - 688 CC.. 0602.. CC.. 09T3..</p>	<p>SDAC 90°</p> <p>PAGE C - 689 DC.. 0702.. DC.. 11T3..</p>	<p>SDJC 93°</p> <p>PAGE C - 690 DC.. 0702.. DC.. 11T3..</p>	<p>SDNC 62°30'</p> <p>PAGE C - 691 DC.. 0702.. DC.. 11T3..</p>	<p>STJC 93°</p> <p>PAGE C - 692 TC.. 1102..</p>
<p>SVAC 90°</p> <p>PAGE C - 693 VC.. 1103.. VC.. 1604..</p>	<p>SVJC 93°</p> <p>PAGE C - 694 VC.. 1103.. VC.. 1604..</p>	<p>SVVC 72°30'</p> <p>PAGE C - 695 VC.. 1103..</p>			

CENTER SCREW TOOLHOLDERS

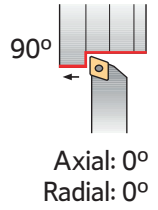

Finishing	Finishing	Finishing	Finishing	Finishing	Medium to Finishing
Flat	FP	BO	FM	FK	LM
(06-09)	(06-09)	(06-09)	(06-09)	(06-09)	(06-09)
Medium	Medium	Medium	Medium to Finishing wiper	Finishing to Fine finishing	Medium to Finishing
MP	MM	MK	MW	FS	LN
(06-09)	(06-09)	(06-09)	(06-09)	(06-09)	(06-09)

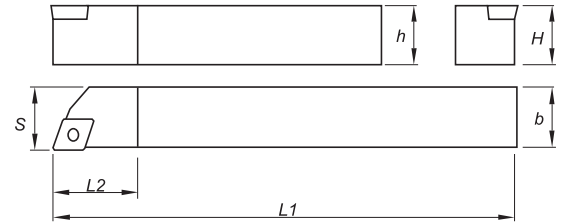

Order Code		Reference	Dimensions (mm)					Insert	Kg	Stock	
R	L		H=h	b	L1	L2	S			R	L
212251300	212251400	SCAC R/L 0808 M06	8	8	150	8	8	CC.. 0602..	0,070		
212251500	212251600	SCAC R/L 1010 M06	10	10	150	10	10	CC.. 0602..	0,110		
212251700	212251800	SCAC R/L 1212 M06	12	12	150	12	12	CC.. 0602..	0,150		
212251900	212252000	SCAC R/L 1616 M06	16	16	150	16	16	CC.. 0602..	0,280		
212252100	212252200	SCAC R/L 1212 M09	12	12	150	12	12	CC.. 09T3..	0,150		
212252300	212252400	SCAC R/L 1616 M09	16	16	150	16	16	CC.. 09T3..	0,280		

Stock Items | Itens de stock

Available under request | Disponível sob consulta | Disponible bajo consulta

SPARE PARTS || Complementos | Repuestos

Cutter Reference	Screw	Wrench
SCAC R/L 0808 M06	P0250700	XT07
SCAC R/L 1010 M06	P0250700	XT07
SCAC R/L 1212 M06	P0250700	XT07
SCAC R/L 1616 M06	P0250700	XT07
SCAC R/L 1212 M09	P0401100	XT15-S35
SCAC R/L 1616 M09	P0401100	XT15-S35

C
TURNING
Insert selection
Overview
Negative inserts
Positive inserts
PCBN & PCD inserts
Heavy turning
External Toolholders
Internal Toolholders
Automatic Lathes
Spare Parts
Technical Data

CENTER SCREW TOOLHOLDERS

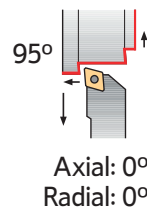

Finishing	Finishing	Finishing	Finishing	Finishing	Medium to Finishing
Flat	FP	BO	FM	FK	LM
(06-09)	(06-09)	(06-09)	(06-09)	(06-09)	(06-09)
Medium	Medium	Medium	Medium to Finishing wiper	Finishing to Fine finishing	Medium to Finishing
MP	MM	MK	MW	FS	LN
(06-09)	(06-09)	(06-09)	(06-09)	(06-09)	(06-09)

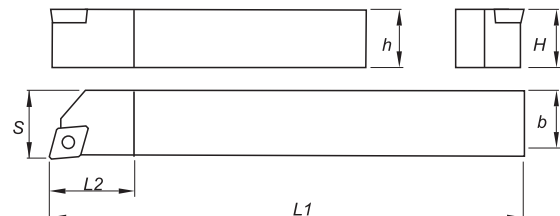

Order Code		Reference	Dimensions (mm)					Insert	Kg	Stock	
R	L		H=h	b	L1	L2	S			R	L
212252500	212252600	SCLC R/L 0808 M06	8	8	150	8	8	CC.. 0602..	0,070		
212252700	212252800	SCLC R/L 1010 M06	10	10	150	10	10	CC.. 0602..	0,110		
212252900	212253000	SCLC R/L 1212 M06	12	12	150	12	12	CC.. 0602..	0,150		
212253100	212253200	SCLC R/L 1616 M06	16	16	150	16	16	CC.. 0602..	0,280		
212253300	212253400	SCLC R/L 1212 M09	12	12	150	12	12	CC.. 09T3..	0,150		
212253500	212250400	SCLC R/L 1616 M09	16	16	150	16	16	CC.. 09T3..	0,280		

Stock Items | Itens de stock







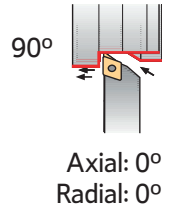

Available under request | Disponível sob consulta | Disponible bajo consulta

SPARE PARTS | Complementos | Repuestos



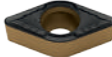

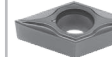



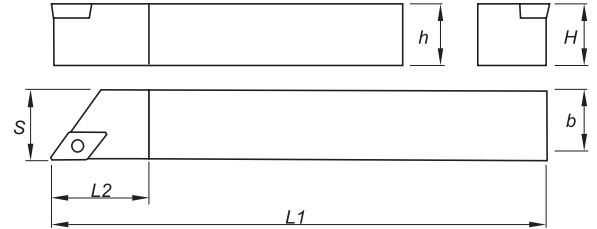



Cutter Reference	Screw	Wrench
SCLC R/L 0808 M06	P0250700	XT07
SCLC R/L 1010 M06	P0250700	XT07
SCLC R/L 1212 M06	P0250700	XT07
SCLC R/L 1616 M06	P0250700	XT07
SCLC R/L 1212 M09	P0401100	XT15-S35
SCLC R/L 1616 M09	P0401100	XT15-S35

CENTER SCREW TOOLHOLDERS



Finishing	Finishing	Finishing	Finishing	Medium to Finishing
Flat	FP	FM	FK	LM
 (07-11)	 (07-11)	 (07-11)	 (07-11)	 (07-11)
Medium	Medium	Medium	Finishing to Fine Finishing	Finishing to Fine Finishing
MP	MM	MK	FS	LN
 (07-11)	 (07-11)	 (07-11)	 (07-11)	 (07-11)





Order Code		Reference	Dimensions (mm)					Insert	Kg	Stock	
R	L		H=h	b	L1	L2	S			R	L
212253600	212253700	SDAC R/L 0808 M07	8	8	150	12,7	8	DC.. 0702..	0,070		
212253800	212253900	SDAC R/L 1010 M07	10	10	150	15,0	10	DC.. 0702..	0,110		
212254000	212254100	SDAC R/L 1212 M07	12	12	150	15,0	12	DC.. 0702..	0,150		
212254200	212254300	SDAC R/L 1616 M07	16	16	150	16,0	16	DC.. 0702..	0,280		
212254400	212254500	SDAC R/L 1212 M11	12	12	150	18,0	12	DC.. 11T3..	0,150		
212254600	212254700	SDAC R/L 1616 M11	16	16	150	20,0	16	DC.. 11T3..	0,280		

 Stock Items | Itens de stock

 Available under request | Disponível sob consulta | Disponible bajo consulta

SPARE PARTS || Complementos | Repuestos







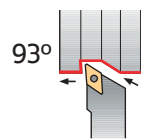

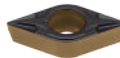

Cutter Reference	Screw	Wrench
		
SDAC R/L 0808 M07	P0250700	XT07
SDAC R/L 1010 M07	P0250700	XT07
SDAC R/L 1212 M07	P0250700	XT07
SDAC R/L 1616 M07	P0250700	XT07
SDAC R/L 1212 M11	P0401100	XT15-S35
SDAC R/L 1616 M11	P0401100	XT15-S35

C
TURNING
Insert selection
Overview
Negative inserts
Positive inserts
PCBN & PCD inserts
Heavy turning
External Toolholders
Internal Toolholders
Automatic Lathes
Spare Parts
Technical Data

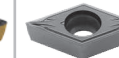



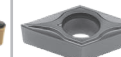



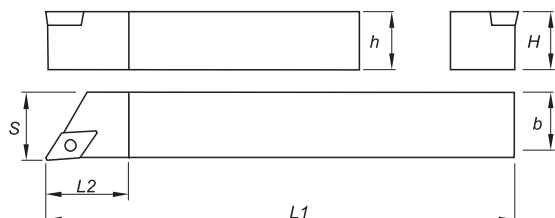



CENTER SCREW TOOLHOLDERS



Axial: 0°
Radial: 0°

Finishing	Finishing	Finishing	Finishing	Finishing wiper	Medium to Finishing
Flat	FP	FM	FK	FW	LM
 (07-11)	 (07-11)	 (07-11)	 (07-11)	 (07-11)	 (07-11)
Medium	Medium	Medium	Medium to Finishing wiper	Finishing to Fine Finishing	Finishing to Fine Finishing
MP	MM	MK	MW	FS	LN
 (07-11)	 (07-11)	 (07-11)	 (11)	 (07-11)	 (07-11)



Order Code		Reference	Dimensions (mm)					Insert	Kg	Stock	
R	L		H=h	b	L1	L2	S			R	L
212254800	212254900	SDJC R/L 0808 M07	8	8	150	8	8	DC.. 0702..	0,070		
212255000	212255100	SDJC R/L 1010 M07	10	10	150	10	10	DC.. 0702..	0,110		
212255200	212255300	SDJC R/L 1212 M07	12	12	150	12	12	DC.. 0702..	0,150		
212255400	212255500	SDJC R/L 1616 M07	16	16	150	16	16	DC.. 0702..	0,280		
212255600	212255700	SDJC R/L 1212 M11	12	12	150	12	12	DC.. 11T3..	0,150		
212255800	212255900	SDJC R/L 1616 M11	16	16	150	16	16	DC.. 11T3..	0,280		

 Stock Items | Itens de stock

 Available under request | Disponível sob consulta | Disponible bajo consulta

SPARE PARTS | Complementos | Repuestos

Cutter Reference	Screw	Wrench
		
SDJC R/L 0808 M07	P0250700	XT07
SDJC R/L 1010 M07	P0250700	XT07
SDJC R/L 1212 M07	P0250700	XT07
SDJC R/L 1616 M07	P0250700	XT07
SDJC R/L 1212 M11	P0401100	XT15-S35
SDJC R/L 1616 M11	P0401100	XT15-S35

CENTER SCREW TOOLHOLDERS

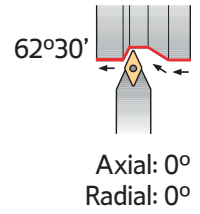

Finishing	Finishing	Finishing	Finishing	Medium to Finishing
Flat	FP	FM	FK	LM
(07-11)	(07-11)	(07-11)	(07-11)	(07-11)
Medium	Medium	Medium	Finishing to Fine Finishing	Finishing to Fine Finishing
MP	MM	MK	FS	LN
(07-11)	(07-11)	(07-11)	(07-11)	(07-11)

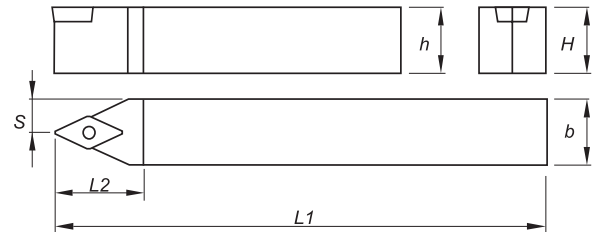

Order Code	Reference	Dimensions (mm)					Insert	Kg	Stock
		H=h	b	L1	L2	S			
212256000	SDNC N 1010 M07	10	10	150	15	5,2	DC.. 0702..	0,100	
212256100	SDNC N 1212 M11	12	12	150	21	6,2	DC.. 11T3..	0,140	
212256200	SDNC N 1616 M11	16	16	150	21	8,6	DC.. 11T3..	0,270	

Stock Items | Itens de stock

Available under request | Disponível sob consulta | Disponible bajo consulta







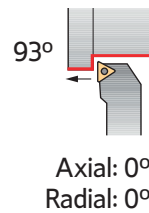

SPARE PARTS | Complementos | Repuestos

Cutter Reference	Screw	Wrench
SDNC N 1010 M07	P0250700	XT07
SDNC N 1212 M11	P0401100	XT15-S35
SDNC N 1616 M11	P0401100	XT15-S35





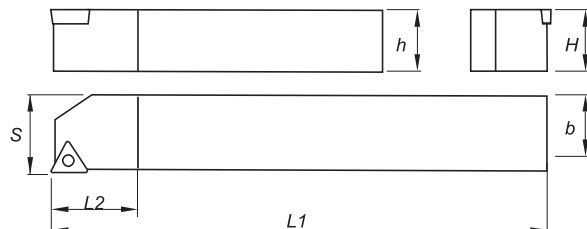

C
TURNING
Insert selection
Overview
Negative inserts
Positive inserts
PCBN & PCD inserts
Heavy turning
External Toolholders
Internal Toolholders
Automatic Lathes
Spare Parts
Technical Data

CENTER SCREW TOOLHOLDERS



Finishing	Finishing	Finishing	Finishing	Finishing wiper
Flat  (09-11-16)	FP  (09-11-16)	FM  (09-11-16)	FK  (09-11-16)	FW  (09-11-16)
Medium	Medium	Medium	Medium to Finishing	
MP  (09-11-16)	MM  (09-11-16)	MK  (09-11-16)	LN  (11-16)	





Order Code		Reference	Dimensions (mm)					Insert	Kg	Stock	
R	L		H=h	b	L1	L2	S			R	L
212256300	212256400	STJC R/L 1010 M11	10	10	150	16	10	TC.. 1102..	0,110		
212256500	212256600	STJC R/L 1212 M11	12	12	150	16	12	TC.. 1102..	0,150		
212256700	212256800	STJC R/L 1616 M11	16	16	150	16	16	TC.. 1102..	0,280		

 Stock Items | Itens de stock







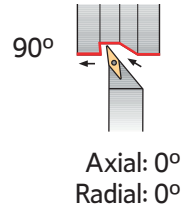

 Available under request | Disponível sob consulta | Disponible bajo consulta

SPARE PARTS | Complementos | Repuestos









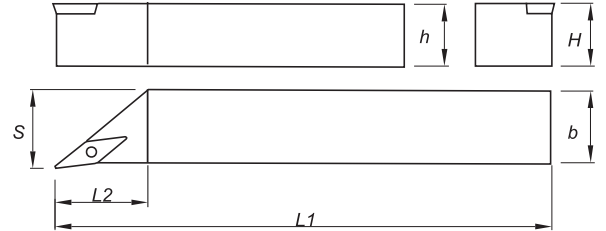



Cutter Reference	Screw 	Wrench 
STJC R/L 1010 M11	P0250700	XT07
STJC R/L 1212 M11	P0250700	XT07
STJC R/L 1616 M11	P0250700	XT07

CENTER SCREW TOOLHOLDERS



Finishing	Finishing	Finishing	Finishing
Flat  (11-16)	FP  (11-16)	FM  (11-16)	FK  (11-16)
Medium	Medium	Medium	Medium to Finishing
MP  (11-16)	MM  (11-16)	MK  (11-16)	LN  (11-16)



Order Code		Reference	Dimensions (mm)					Insert	Kg	Stock	
R	L		H=h	b	L1	L2	S			R	L
212256900	212257000	SVAC R/L 0808 M11	8	8	150	26	8	VC.. 1103..	0,070		
212257100	212257200	SVAC R/L 1010 M11	10	10	150	26	10	VC.. 1103..	0,100		
212257300	212257400	SVAC R/L 1212 M11	12	12	150	26	12	VC.. 1103..	0,140		
212257500	212257600	SVAC R/L 1616 M11	16	16	150	26	16	VC.. 1103..	0,270		
212257700	212257800	SVAC R/L 1212 M16	12	12	150	40	12	VC.. 1604..	0,140		
212257900	212258000	SVAC R/L 1616 M16	16	16	150	40	16	VC.. 1604..	0,270		

 Stock Items | Itens de stock

 Available under request | Disponível sob consulta | Disponible bajo consulta

SPARE PARTS | Complementos | Repuestos





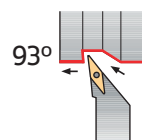

Cutter Reference	Screw	Wrench
		
SVAC R/L 0808 M11	P0250700	XT07
SVAC R/L 1010 M11	P0250700	XT07
SVAC R/L 1212 M11	P0250700	XT07
SVAC R/L 1616 M11	P0250700	XT07
SVAC R/L 1212 M16	P0401100	XT15-S35
SVAC R/L 1616 M16	P0401100	XT15-S35

C
TURNING
Insert selection
Overview
Negative inserts
Positive inserts
PCBN & PCD inserts
Heavy turning
External Toolholders
Internal Toolholders
Automatic Lathes
Spare Parts
Technical Data

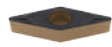







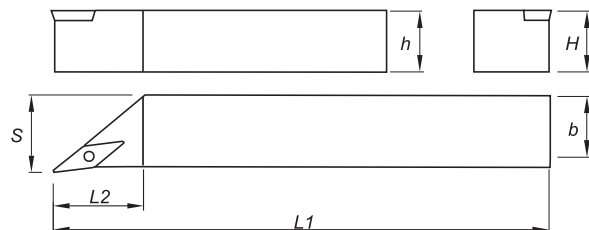



CENTER SCREW TOOLHOLDERS



Axial: 0°
Radial: 0°

Finishing	Finishing	Finishing	Finishing
Flat  (11-16)	FP  (11-16)	FM  (11-16)	FK  (11-16)
Medium	Medium	Medium	Medium to Finishing
MP  (11-16)	MM  (11-16)	MK  (11-16)	LN  (11-16)



Order Code		Reference	Dimensions (mm)					Insert	Kg	Stock	
R	L		H=h	b	L1	L2	S			R	L
212258100	212258200	SVJC R/L 0808 M11	8	8	150	26	8	VC.. 1103..	0,070		
212258300	212258400	SVJC R/L 1010 M11	10	10	150	26	10	VC.. 1103..	0,100		
212258500	212258600	SVJC R/L 1212 M11	12	12	150	26	12	VC.. 1103..	0,140		
212258700	212258800	SVJC R/L 1616 M11	16	16	150	26	16	VC.. 1103..	0,270		
212258900	212259000	SVJC R/L 1212 M16	12	12	150	40	12	VC.. 1604..	0,140		
212259100	212259200	SVJC R/L 1616 M16	16	16	150	40	16	VC.. 1604..	0,270		









 Stock Items | Itens de stock

Available under request | Disponível sob consulta | Disponible bajo consulta





SPARE PARTS | Complementos | Repuestos

Cutter Reference	Screw	Wrench
		
SVJC R/L 0808 M11	P0250700	XT07
SVJC R/L 1010 M11	P0250700	XT07
SVJC R/L 1212 M11	P0250700	XT07
SVJC R/L 1616 M11	P0250700	XT07
SVJC R/L 1212 M16	P0401100	XT15-S35
SVJC R/L 1616 M16	P0401100	XT15-S35

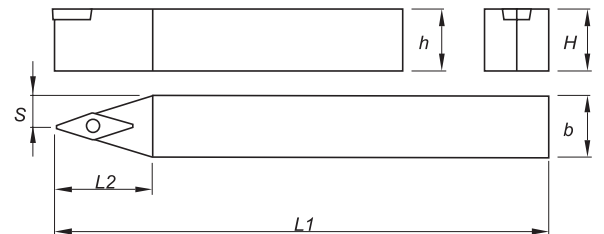
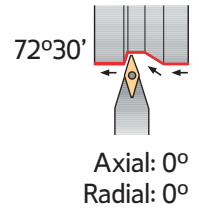
CENTER SCREW TOOLHOLDERS

Finishing	Finishing	Finishing	Finishing
Flat	FP	FM	FK
 (11)	 (11)	 (11)	 (11)
Medium	Medium	Medium	Medium to Finishing
MP	MM	MK	LN
 (11)	 (11)	 (11)	 (11)



Order Code	Reference	Dimensions (mm)					Insert	Kg	Stock
		H=h	b	L1	L2	S			
212259300	SVVC N 0808 M11	8	8	150	21	4,3	VC.. 1103..	0,070	
212259400	SVVC N 1010 M11	10	10	150	21	5,3	VC.. 1103..	0,100	
212259500	SVVC N 1212 M11	12	12	150	21	6,3	VC.. 1103..	0,140	
212259600	SVVC N 1616 M11	16	16	150	21	8,3	VC.. 1103..	0,260	

 Stock Items | Itens de stock

 Available under request | Disponível sob consulta | Disponible bajo consulta

SPARE PARTS | Complementos | Repuestos

Cutter Reference	Screw	Wrench
		
SVVC N 0808 M11	P0250700	XT07
SVVC N 1010 M11	P0250700	XT07
SVVC N 1212 M11	P0250700	XT07
SVVC N 1616 M11	P0250700	XT07

SPARE PARTS

CHIP BREAKERS | Quebra Aparas | Rompevirutas

QCS0900 290071500 	QCS1200 290071700 	QCS1201 290072200 	QCS1900 290071900 	QCS1901 290072400 	QCS0901 290072600
QCS0902 290072900 	QCS1202 290072700 	QCT1100 290071600 	QCT1101 290072100 	QCT1600 290071800 	QCT1601 290072300
QCT2200 290072000 	QCT2201 290072500 				

CLAMPS (C HOLDERS) | Grampos (Suportes C) | Tornillos Para Brida (Soportes C)

GS03000 290065100 	GS04000 290009700 	GS05002 290065900 	GS05000 290055800 	GS05004 290066500 	GS05001 290065800
GS05003 290066000 	GS06001 290047700 	GS06002 290046300 	GS06003 290066200 	GS06000 290010500 	GS05005 290005900
GS08001 290066600 	GS08000 290030100 				

CLAMPS (D HOLDERS) | Grampos (Suportes D) | Bidas (Soportes D)

<p>GA05001 290082000</p>	<p>GA07002 290082100</p>	<p>GA07001 290066300</p>	<p>GA07003 290082200</p>	<p>GAW1400 290031800</p>	<p>GAW1401 290066400</p>
-------------------------------------	-------------------------------------	-------------------------------------	-------------------------------------	-------------------------------------	-------------------------------------

DIFFERENTIALS SCREWS | Parafusos Diferenciales | Tornillos Diferenciales

<p>F0602100 290062700 Allen 3</p>	<p>F0802900 290062300 Allen 4</p>	<p>F0602100 290062700 Allen 3</p>
--	--	--

LEVERS | Alavanca | Palanca

<p>AN07800 290048700</p>	<p>AN01200 290031200</p>	<p>AN13100 290009000</p>	<p>AN17100 290047200</p>	<p>AN17200 290070500</p>	<p>AN20800 290047300</p>
<p>AN25200 290070600</p>	<p>AN14700 290071400</p>	<p>AN09500 290052800</p>	<p>AC11700 290019200</p>	<p>AC13300 290019300</p>	<p>AC18700 290070800</p>
<p>AC23000 290070900</p>	<p>AC26700 290071000</p>	<p>AC13200 290071300</p>	<p>AC18000 290070700</p>	<p>AN12100 290071100</p>	<p>AN20200 290071200</p>

SPARE PARTS

LEVER SCREWS | Parafusos Para Alavanca | Tornillos De Palanca

PA0501000 290048800 Allen 2 	PA0501200 290063000 Allen 2 	PA0501400 290019000 Allen 2 	PA0601300 290063200 Allen 2,5 	PA0601700 290018900 Allen 2,5 	PA0602100 290064400 Allen 2,5
PA0801700 290063800 Allen 3 	PA0802100 290011900 Allen 3 	PA0802101 290063300 Allen 3 	PA0802300 290047100 Allen 3 	PA0802400 290064500 Allen 3 	PA1002700 290048600 Allen 4
PA1003000 290064600 Allen 4 	PA1203600 290063100 Allen 5 				

LOCK PINS | Cavilhas De Bloqueio | Pines De Bloqueo

BC04502 290063500 	BC04501 290063600 	BC04500 290063400 	BC06001 290063700 	BC06000 290053500 	BC08000 290064200
BS05000 290054400 Allen 2 	BS1-402 290064300 Allen 2,5 	BS1-400 290063900 Allen 2,5 	BS1-401 290064000 Allen 2,5 	BS3-800 290064100 Allen 4 	

SCREWS (ALLEN) | Parafusos (Allen) | Tornillos (Allen)

<p>D0300691 290064800 Allen 2</p>	<p>D0400691 290064900 Allen 2.5</p>	<p>T05003500 290020100 Allen 3.5</p>	<p>T05008000 290082300 Allen 2</p>	<p>T06004000 290008700 Allen 4</p>	<p>T06010000 290082400 Allen 2.5</p>
<p>T06015000 290082500 Allen 3</p>	<p>D0300700 290012000 Allen 5</p>	<p>D0400900 290053700 Allen 5</p>	<p>D0401200 290082600 Allen 5</p>	<p>D0500801 290082700 Allen 5</p>	<p>D0501200 290082800 Allen 5</p>
<p>D0601400 290062800 Allen 5</p>	<p>D0602200 290062900 Allen 5</p>	<p>D0602900 290082900 Allen 4</p>	<p>D0601200 290083000 Allen 4</p>	<p>D0801600 290083100 Allen 4</p>	<p>DW142600 290018200 Allen 4</p>
<p>D0702800 290048100 Allen 4</p>					

SCREWS (TORX) | Parafusos (torx) | Tornillos (torx)

<p>P0220600 290026000 TorxT-6</p>	<p>P0250700 290013400 TorxT-7</p>	<p>P0200601 290010700 TorxT-7</p>	<p>P0300900 290007500 TorxT-8</p>	<p>P0351500 290020000 TorxT-15</p>	<p>P0401400 290031100 TorxT-15</p>
<p>P0400802 290006500 TorxT-15</p>	<p>P0401100 290007000 TorxT-15</p>	<p>P0501200 290026200 TorxT-20</p>	<p>P0801411 290062600 TorxT-25</p>		

SPARE PARTS

SHIM PINS | Pino calço | Pino cuña

BE02100 290020500 	BE03000 290038900 	BE04400 290007300 	BE05500 290069200 	BE03800 290019100 	BE05401 290069900
BE08300 290069700 	BE07000 290069300 	BE05400 290069400 	BE08301 290069800 	BE08500 290069500 	BE10500 290069600
BF04806 290070000 	BF04808 290070100 	BF04813 290018100 	BF04815 290070200 		

SHIM PIN PUNCHES | Calço | Cuña

BF40009 290033200 	BF47509 290020600 	BF65012 290061900 	BF80012 290062000 	BF12520 290062100
---------------------------------	---------------------------------	---------------------------------	---------------------------------	---------------------------------

SHIMS (C SHAPES) | Colchões (Pastilhas C) | Placas Base (Plaquetas C)

CC090300 290067800 	CC120301 212127000 	CC160500 290046400 	CC190500 212169300 	CC250700 290067900 	CC120401 212166800
CC120600 290083200 	CC120500 290055200 	CC120300 290083300 	CC190502 290073200 		

SHIMS (D SHAPES) | Colchões (Pastilhas D) | Placas Base (Plaquitas D)

<p>CD110300 290068000</p>	<p>CD110301 212166900</p>	<p>CD110302 290083400</p>	<p>CD150300 290068100</p>	<p>CD150500 290068200</p>	<p>CD150501 290073300</p>
--------------------------------------	--------------------------------------	--------------------------------------	--------------------------------------	--------------------------------------	--------------------------------------

SHIMS (R SHAPES) | Colchões (Pastilhas R) | Placas Base (Plaquitas R)

<p>CR090300 290068700</p>	<p>CR100300 212054600</p>	<p>CR100301 212167100</p>	<p>CR120300 212054700</p>	<p>CR120301 212167200</p>	<p>CR120302 290068800</p>
<p>CR150500 290068900</p>	<p>CR160500 290068300</p>	<p>CR190500 290069000</p>	<p>CR200500 290068400</p>	<p>CR250600 290068500</p>	<p>CR250601 290069100</p>
<p>CR320600 290068600</p>					

SHIMS (S SHAPES) | Colchões (Pastilhas S) | Placas Base (Plaquitas S)

<p>CS090300 290067100</p>	<p>CS090301 290067500</p>	<p>CS120300 212056100</p>	<p>CS120400 212044300</p>	<p>CS120302 290067600</p>	<p>CS120500 290053800</p>
<p>CS120600 290083500</p>	<p>CS150400 290083900</p>	<p>CS190501 290083600</p>	<p>CS190300 290067200</p>	<p>CS190400 290084000</p>	<p>CS250600 290053000</p>

SPARE PARTS

SHIMS (T SHAPES) | Colchões (Pastilhas T) | Placas Base (Plaquetas T)

CT160301 212026000 	CT160303 212039600 	CT160302 212039900 	CT160304 290073400 	CT160600 290083700 	CT220301 212127500
CT220302 290061700 	CT220500 290052700 	CT220600 290083800 	CT270500 290061500 	CT330500 290067400 	

SHIMS (V SHAPES) | Colchões (Pastilhas V) | Placas Base (Plaquetas V)

CV160301 290054300 	CV160300 212044400 	CV220400 212167000
----------------------------------	----------------------------------	----------------------------------

SHIMS (W SHAPES) | Colchões (Pastilhas W) | Placas Base (Plaquetas W)

CW060301 212169100 	CW060300 290067000 	CW080300 212169200 	CW080500 290053400
----------------------------------	----------------------------------	----------------------------------	----------------------------------

SHIMS (KNUX SHAPES) | Colchões (Pastilhas Knux) | Placas Base (Plaquetas Knux)

CK160500 212127100 	CK160501 290067300
----------------------------------	----------------------------------

SPRINGS | Mola | Muelle

M06511 290070300 	M09513 290054100
--------------------------------	--------------------------------

WEDGE CLAMPS (M HOLDERS) | Grampos Cunhas (Suportes M) | Tornillos Para Cuñas (Soportes M)

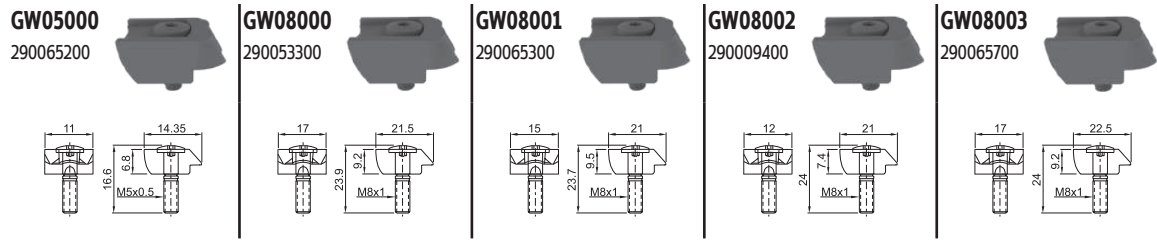

WEDGE CLAMPS (M-K HOLDERS) | Grampos Cunhas (Suportes M-K) | Tornillos Para Cuñas (Soportes M-K)

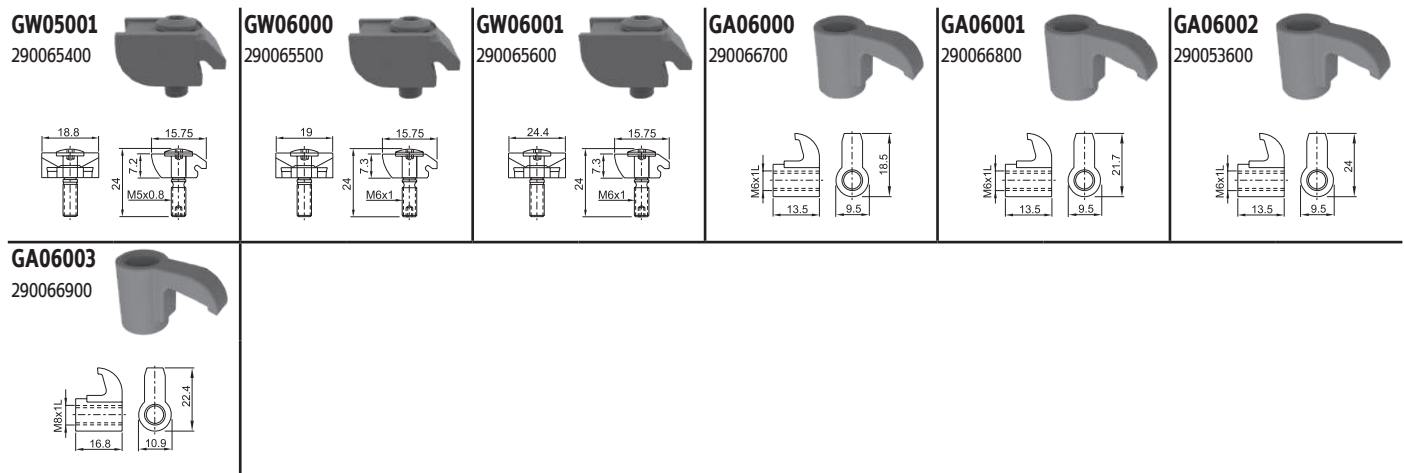

WRENCHES (ALLEN) | Chaves (Allen) | Llaves (Allen)

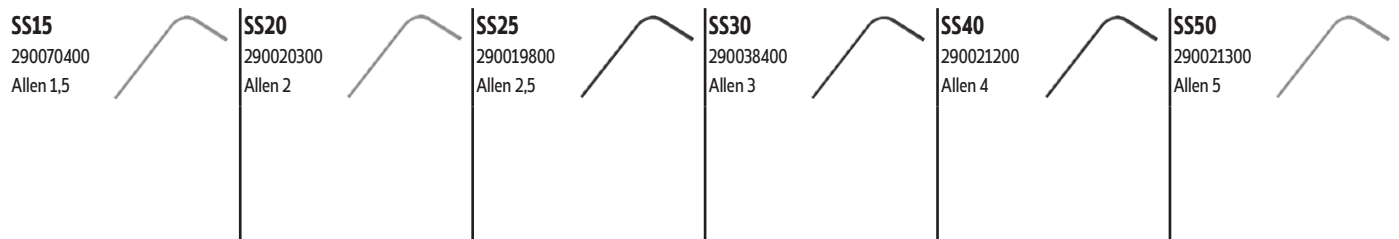

WRENCHES (TORX) | Chaves (Torx) | Llaves (Torx)

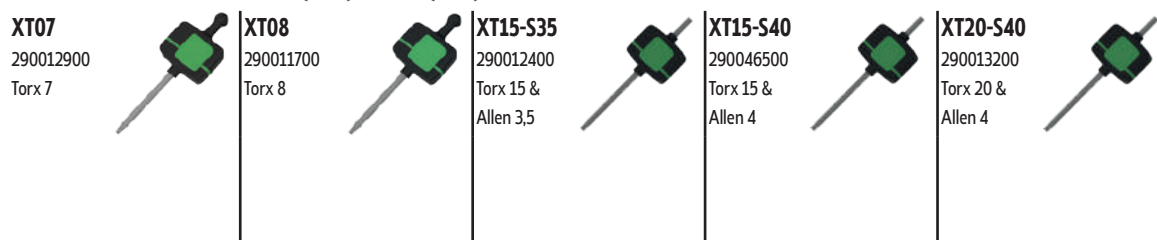

TURNING GRADES | Graus de torneamento | Calidades para torneado

	1	5	10	15	20	25	30	35	40	45	50		
TURNING	P STEEL		PH7910									PVD	
				PH7920									
			PHG105										CVD
				PHG115									
				PH5115									
						PHG125							
						PH5125							
							PHG135						
							PHG140						
							PH5740						
M STAINLESS SEEL		PHH910 ^{NEW}										PVD	
		PH7910											
				PHH920 ^{NEW}								CVD	
			PH7920										
			PHS215										
				PHS225									
						PHS240							
									PHS228				
K CAST IRON			PH5705									CVD	
			PH5320										
					PH5740								
			PBH920									PCBN	
				PBY930 ^{NEW}									
				PBY940 ^{NEW}									

TURNING GRADES | Graus de torneamento | Calidades para torneado

	1	5	10	15	20	25	30	35	40	45	50		
N ALUMINIUM & NON FERROUS		PH0910											UNCOTED
		PDP410											PCD
		PDP403											
S HEAT RESISTANT / TITANIUM ALLOYS			PHH910									PVD	
			PH7910										
			PHH920									PCBN	
			PH7920										
						PBH920							
			PBY603										
H HARDENED MATERIALS		PBY603										PCBN	
			PBY620										
					PBY920								
					PBY930								
					PBY940								

- TURNING
- Insert selection
- Overview
- Negative inserts
- Positive inserts
- PCBN & PCD inserts
- Heavy turning
- External Toolholders
- Internal Toolholders
- Automatic Lathes
- Spare Parts
- Technical Data

TURNING GRADES DESCRIPTION

PVD GRADES

PHH...

A thin PVD coating. 1st choice for finishing operations stainless steels and HRSA.



PHH910 NEW
M05-M10
S05-S15

An hard micro grain substrate combined with a thin optimized nanostructure PVD coating with excellent heat dissipation

The solution for Stainless steel and HRSA from medium turning to finishing.
For continuous to semi-interrupted turning.
First choice for HRSA.

PHH920 NEW
M10-M25
S15-S30

A micro grain substrate combined with a thin optimized nanostructure PVD coating with excellent heat dissipation

Solution for general turning of stainless steels and HRSA.



PH7...

A thin PVD coating recommended for finishing operations on steels and suitable for stainless steels and HRSA. Work well on "gummy" materials.



PH7910
P05-P10
M05-M10
S05-S15

PH7920
P10-P35
M05-M10
S05-S15

CVD GRADES

PHS...

A medium temperature CVD coating with great adhesion and great heat dissipation properties. 1st choice for machining stainless steels.



PHS215
M10-M25

Suitable for high to medium cutting speeds in stainless steel. Ideal for turning on good condition of cut (continuous cut).

PHS225
M15-M30

First choice for general application on turning of stainless steel.

PHS240
M25-M45

First choice for roughing to heavy roughing operations with interrupted cut at medium to low cutting speeds on stainless steel.

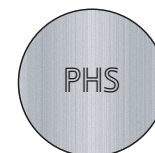

PH0910

Uncoated carbide micro-grain grade combining a good abrasive wear resistance and toughness. Suitable for rough to finish operations of aluminum alloys.

PH0910
N01-N20

PHG...

A medium temperature CVD coating with great adhesion and great wear protection. 1st choice for machining steels.

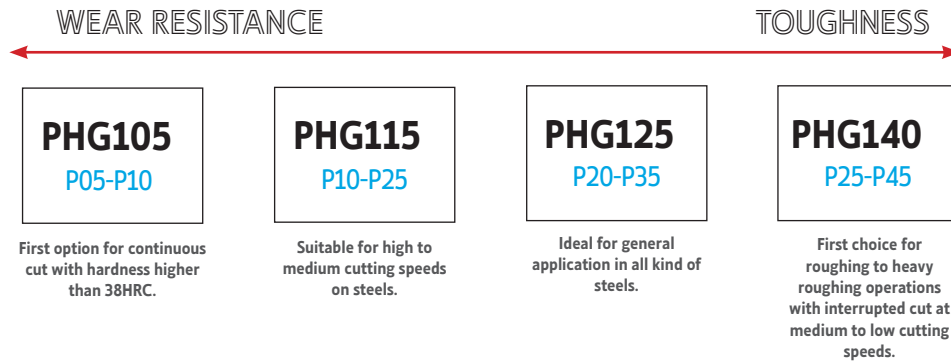

PH5...

A thick CVD coating with smooth surface. 1st choice for machining cast irons.

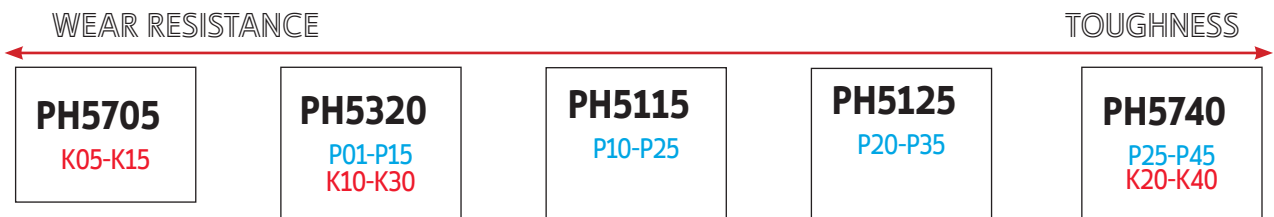

PCBN

PCBN insert excel in the finishing and semi-finishing process of hardened steels as well as hard cast iron and HRSA.

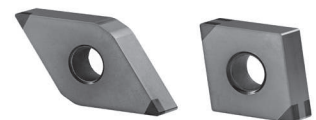

PCD

PCD insert are an achievement of extreme significance for the machining of Non-Ferrous Materials, such as high-silicon aluminium, metal matrix composites (MMC) and carbon fiber reinforced plastics (CFRP).

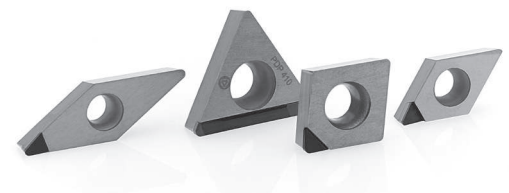

General purpose Fine surface finishing. <14% silicon aluminium alloy

Highest abrasion resistance Bimodal grain structure for increased diamond percentage content. >14% silicon aluminium alloy

GRADES COMPARATIVE CHART

PVD COATED GRADES | GRAUS REVESTIDOS A PVD | CALIDADES CON RECUBRIMIENTO PVD

ISO	Palbit	Sandvik	Kennametal	Iscar	Seco	Mitsubishi	Sumitomo	Tungaloy	Walter	Kyocera	Taegutec	Korloy	Ceratizit
Material													
P	P01	PH7910								PR915 PR1005	PV3030	PC8110	
	P10	PH7910	GC1525 GC1025	KC5010 KC5510 KU10T	IC250 IC350 IC507 IC570 IC807 IC907 IC908	CP200 TS2001	VP10MF	AH710		PR915 PR1005 PR930 PR1025 PR1115 PR1225 PR1425	PV3010 PV3030 TT7080 TT1040	PC230	
	P20	PH7920	GC1525 GC1025 GC1125	KC5025 KC5525 KC7215 KC7315 KU25T	IC228 IC250 IC308 IC328 IC350 IC354 IC507 IC528 IC570 IC807 IC808 IC907 IC908 IC928 IC1008 IC1028 IC3028	CP250 TS2500	VP10RT VP20RT VP15TF VP20MF	AC520U	AH710 AH725 AH120 SH730 GH730 GH130	PR930 PR1025 PR1115 PR1225	TT7220 TT9020 TT7080 TT9080 TT7070	PC5300 PC8115	SR226 GM127
	P30	PH7920	GC1025 GC1125	KC7015 KC7020 KU25T KC7235	IC228 IC250 IC328 IC330 IC354 IC528 IC1008 IC1028 IC3028	CP500	VP10RT VP20RT VP20MF	AC530U	AH725 AH120 SH730 GH730 GH130 AH740 J740		TT9030 TT7030 TT7080 TT9030 TT9080	PC8115	GM40 CTP1235 CTP2235 SR226 GM127
M	M01	PH7910	GC1005		IC520	TS2000 CP200	VP10MF		WSM10	PR915	TT5080		
	M10	PH7910	GC1005 GC1025 GC1125 GC1105	KC5010 KC5510 KC6005 KC6015	IC330 IC354 IC507 IC520 IC570 IC807 IC907 IC3028	CP200 TS2000	VP10MF	AH710	WSM20	PR915 PR1025 PR1225 PR1425	TT5030 PV3010 PV3030 TT9030	PC8110 PC9030	
	M20	PH7920	GC1005 GC1025 GC1125 GC1105	KC5025 KC5525 KC7020 KC7025	IC250 IC330 IC354 IC808 IC908 IC1008 IC1028 IC3028	CP250 TS2500 CP500	VP10RT VP20RT VP15TF VP20MF	AC520U	WSM30	PR1025 PR1125 PR1225 PR915 PR930	TT5030 PV3030 TT9020 TT9030	PC9030 PC8110 PC8115	CTP2120 CTP1235 SR226 GM127
	M30	PH7920	GC1125 GC2035	KC7030 KC7225	IC228 IC250 IC328 IC330 IC1008 IC1028 IC3028	CP500	VP10RT VP20RT VP15TF VP20MF MP7035	AC520U AC530U	GH330 AH725 AH120 AH730 GH730 GH130 J740 AH645	PR1125	TT9030 TT9080 TT8030	PC9030	CTP2240 CTP1235 CTP2235 SR226 GM127
STEEL													

PH7910 = Best available choice

ISO		Palbit	Sandvik	Kennametal	Iscar	Seco	Mitsubishi	Sumitomo	Tungaloy	Walter	Kyocera	Taegutec	Korloy	Ceratizit
Material														
S HEAT RESISTENT / TITANIUM ALLOYS	S01	PH7910 PHH910			IC507 IC907		MP9005 VP05RT		AH905 AH905 SH730	WDSM10	PR915		PC8110	
	S10	PH7910 PHH910	GC1105 GC1005 GC1025	KC5010 KC5410 KC5510	IC507 IC903 IC300 IC808	CP200 CP250 TS2000 TS2500 CP250	MP9015 VP10RT MP9015	AC510U	AH110 AH120	WSM20	PR915	TT5030 TT5030	PC8110 PC8115 PC8105	CM40 SR226 CM45
	S20	PH7920 PHH920	GC1025 GC1125	KC5025 KC5525	IC908 IC928 IC3028 IC806	TS2500 CP500	MT9015 VP20RT	AC510U AC520U	AH120 AH720	WSM30	PR1125	TT8020 TT8030	PC8815 PC5300	CTP2440 GM127
	S30	PH7920 PHH920	GC1125				VP15TF	AC520U	AH725		PR1125	TT8020	PC5400	CTP2135

PHH910 = Best available choice



TURNING

Insert selection

Overview

Negative inserts

Positive inserts

PCBN & PCD inserts

Heavy turning

External Toolholders

Internal Toolholders

Automatic Lathes

Spare Parts

Technical Data

GRADES COMPARATIVE CHART

CVD COATED GRADES | GRAUS REVESTIDOS A CVD | CALIDADES CON RECUBRIMIENTO CVD

ISO	Palbit	Sandvik	Kennametal	Iscar	Seco	Mitsubishi	Sumitomo	Tungaloy	Walter	Kyocera	Taegutec	Korloy	Ceratizit	
Material														
P	P05	PHG105	GC4205 GC4005	KCP05 KC9105	IC9150 IC8150 IC428	TP0500 TP1500	UE6105	AC810P AC700G	T9105 T9005	WPP01	CA510 CA5505	TT1300	NC3010	
	P10	PHG105 PH5115 PHG115	GC4315 GC4215 GC4015 GC4325	KCP10B KCP10 KCP25 KCP110	IC9150 IC9015 IC8150 IC8250	TP1500 TP2500	UE6105 MC6015 UE6110 MY5015	AC810P AC700G AC820P AC2000	T9105 T9005 T9115	WPP01 WPP05	CAS510 CA5505 CA515 CA5515	TT1300 TT7310 TT7400	NC3215	CTC1110 CTC1115 CTC3110 TCC410
	P20	PH5115 PHG115 PH5125 PHG125	GC4315 GC4215 GC4015 GC4325 GC4225 GC4025	KCP25B KCP25 KCP125	IC9015 IC8250 IC9050 IC9250 IC8350	TP2500	MC6015 UE6110 MC6025 UE6020 MY5015	AC820P AC2000 AC830P	T9115 T9125	WPP10S WPP20S	CA515 CA5515 CA525 CA5525 CR9025	TT3500 TT5100 TT7400 KT7300 TT7800	NC3220 NC3120	CTC1110 CTC1115 CTC1125 CTC1130 CTC1425
	P30	PH5125 PHG125	GC4325 GC4225 GC4025 GC4235 GC4035	KCP30 KCP40 KCP8050	IC8350 IC9250 IC9350	TP3500 TP3000	MC025 UE6020 UE6035 UH6400	AC830P AC630M	T9125 T9135 T9035	WPP30S	CA525 CA5525 CA530 CA5335 CR9025	TT3500 TT5100 TT7400 KT7300	NC3215 NC3225 NC3120	CTC1125 CTC1130 CTC1135 CTC1425
	P40	PHG140 PH5740	GC4235 GC4035	KCP30 KCP40 KC9040 KC9240 KC9245	IC9350	TP3500 TP3000	UE6035 UH6400	AC630M	T9135 T9035		CA530 CA5535	TT5100 TT7100 KT7300 TT7800	NC500H NC5330	CTC1135 CTC1435 CTC2135
	M	M10	PHS215	GC2015	KCM15	IC9250 IC6015 IC8250	TM2000	MC7015 US7020	AC610M	T9115	WAM20	CA6515		NC9020
M20		PHS215 PHS225	GC2015	KCM15 KC9225	IC9250 IC6015 IC9025 IC656	TM2000	MC7015 US7020 MC7025	AC610M AC6030M AC630M	T6020 T9125		CA6515 CA6525	TT5100	NC9020	CTC1115 CTC1125 CTC1130 CTC1135
M30		PHS225 PHS240	GC2025	KCM25 KC9230	IC9350 IC6025 IC635	TM4000	MC7025 US735	AC6030M AC630M	T6030		CA6525	TT5100 TT7100	NC9025	CTC1125 CTC1135 CTC1425 CTC1435 CTC2135
M40		PHS240	GC2025	KCM35 KC9240 KC9245	IC6025 IC9350	TM4000	US735	AC6030M AC630M				TT7100	NC9025	CTC2135
M50		PHS228	GC2035	KC9245	IC9350								NC9035	
K	K05	PH5705	GC3205 GC3210	KCK05	IC5005 IC9007	TH1500 TK1001 TK1000	MC5005 UC5105	AC405K AC410K	T5105	WAK10	CA4505 CA4010			
	K10	PH5705 PH5320	GC3205 GC3210 GC3215	KCK15B KCK15B KC920 KC9315	IC5005 IC5010 IC9150 IC428 IC4028	TK1001 TK1000 TK2000 TK2001	MC5015 UC5115 MY5015	AC405K AC410K AC415K AC420K AC700G	T5115	WAK20	CA4515 CA4110 CA4115	TT3100 TT7310 TT8115	NC6205 NC6210 NC6215	CTC1110 CTC1115 CTC3110 TCC410 CTC3215
	K20	PH5320	GC3215	KCK20 KC9110 KC9325	IC5010 IC8150 IC9150 IC9015 IC418	TK2001 TK2000	MC5015 UC5115 UE6110 MY5015	AC415K AC420K AC700G AC820P	T5115 T5125	WAK30	CA4515 CA4115 CA4120	TT7310 TT8115	NC6215	CTC1115 CTC1125 CTC1130 CTC1425 CTC3215
	K30	PH5740		KC9125 KC9325	IC9015 IC418		UE6110	AC820P	T5125					TSC30

UNCOATED GRADES | GRAUS NÃO REVESTIDOS | CALIDADES SIN RECUBRIMIENTO

ISO		Palbit	Sandvik	Kennametal	Iscar	Seco	Mitsubishi	Sumitomo	Tungaloy	Walter	Kyocera	Taegutec	Korloy	Ceratzit
Material														
ALUMINIUM	N01	PH0910	H10		IC20				KS05F	WK1	KW10	K10		
	N10		H10 H13A	KU10 K313 K68	IC20 IC08 IC28	890 HX KX	HTi10		TH10	WK1	KW10 KWK15	K10	H01	
	N20		H10 H13A	KU10 K313 K68	IC08 IC28	HX KX 883		H1	KS15F	WK1	KW10 KWK15		H01	

PH7910 = Best available choice



TURNING

Insert selection

Overview

Negative inserts

Positive inserts

PCBN & PCD inserts

Heavy turning

External Toolholders

Internal Toolholders

Automatic Lathes

Spare Parts

Technical Data

CHIP BREAKER COMPARATIVE CHART | Tabela de equivalências de quebra-apanas | Tabla de comparación de rompevirutas
 NEGATIVES | NEGATIVAS | NEGATIVAS

Application		Palbit	Sandvik	Kennametal	Iscar	Seco	Tungaloy	Mitsubishi	Sumitomo	Walter	Kyocera	Taegutec	Korloy	Ceratizit
Mat.	Operations													
STEEL	Finishing	MF	QF	FS, LF	SF, PP TF		O1 TF	PK FH	FA		DP	FA	VF, HU	
	Medium to Finishing	MF, LC	PF, QF, LC MF, R/L-K	FF, FN	F3P, NF, SF	FF2, FF1	TS, TSF, ZF 11, NS, AS, TQ, NM, CB, C	SA, FY, C, SH, MP	SU, FL, SE, SX	NF3, NS6	PQ, VFCJ PQ, GP, PP, HQ, GS, CQ	FG, VF, EA FC, MC, ML, MP	VL	CF, TF
	Medium Wiper	MW*	WL, WF, WMX WM, WR	FW, MW, RW	WF, WG	W-MF2, W-MF3	AFW, FW, ASW, SW	SW	LW, SEW, GUW	NF, NM	WP, WQ	WS, WT		TFQ, TMQ
	Medium to Roughing	PM, MR, GR, MA	PM, QM, XM, XRM	P, MN	M3P, M3M, PP, TF, GN	MR7, MR6, M5, M6	TM, AM, DM, ZM All-round	MA, MH, MP	GU GE, UX	NMT, NM4	HS, PT, GT, CS, PS	PC, MT MC, MG-	VM	TMF, TMM M50
	Roughing	HR, RP", GR, MA	HM, PR MR	RN, RP MR	NR MR	MR6, R5	TH, THS	RP, GH HZ, HL	MU, ME HG	NM5, NM6 NM9	PH All-round	RT	GR, HR	TM, TRM
	Heavy Roughing	RP", HY", HZ"	PR, MR, HR, QR	RM RH	R3P, NM	R4, RR6	TU, TRS, TUS	HM, HX HV	HG, HP HU, HW HF	NR6, NRF NRR	PX	HT, HD RX, RH HY, HZ	GH, VT	TRR, TR, R28, R58 R88
STAINLESS STEEL	Finishing	SF, GS	MF, SM, XF, LC, R/L-K	FP	TF, VL	FF2, FF1, MF1	SF, SA, SS	GM, MS, SH, LM	EX, EG, SU, EF	NF4 NMS	GU, MQ	EA, SF, SU, FG	VP2	CF, F30 M34 F32, TF
	Medium	MS, SF, GS	MM, QM, SM XM, XRM	MP, P	M3M, PP	MF2, FF2, MF5	SM S	MM, MA ES	GU HM	NM4	TK MU	EM, ET	VP3, HS	TMF, M42 M30, M52
	Roughing	SS, RP, HZ"	MR HM, PR	UP, RP	MR, MH	M5, M6, R8, RS, R6	TH, SH, TU	GH, RM, HZ	EM, MU	NR4, NRT, NRS	MS	"GR, VM, VH, GH"	TM, M60, TRM, TMR, TRR R80	
CAST IRON	Medium to Finishing	ST	KF, XF	FN	GN	M4, M5	CF	LK, MA	UZ		C	FG	B25	CF
	Medium	ST, HR, FLAT	KM, QM, XM, XRM	RP, UN		FLAT	CM All-round	MK GK	GZ	NM5	ZS All-round	MT MG	FLAT	M50
	Roughing to Heavy Roughing	HR, FLAT, HZ"	KR Without chipbreaker	Without chipbreaker		MR7, M5	CH Without chip-breaker	RK Without chip-breaker	Without chip-breaker	Without chip-breaker	GC Without chip-breaker	RT	GR	TMR, TR R28, R58, R88
ALUMINIUM	Medium	MS	MF, QM	MS, MP MG	PP	-	P		AX		AH, A3	ML	HA	F32
INTERNAL TOOLHOLDERS	Finishing	GS, SF, MS	SF, SM O1	FS, LS MS		MF1, M1	HRF	FJ, LS	EF EX	NFT NF4	MQ	SF	VP1	
	Medium	SF, SS, DOMX	MM, QM SMR	UP, P, NGP RP	PP	MR3, MR4	HRM, HMM, SA	MS RS GJ	EG MU	NMS NM4, NRS, NR4	TK MS MU	SU	VP2, VP3	M34, M52

MS = Best available choice

*=Wiper

"= Single face insert

CHIP BREAKER COMPARATIVE CHART | Tabela de equivalências de quebra-apanas | Tabla de comparación de rompevirutas
 POSITIVES | POSITIVAS | POSITIVAS - CLEARANCE ANGLE 5°, 7° AND 11° *

Application		Palbit	Sandvik	Kennametal	Iscar	Seco	Tungaloy	Mitsubishi	Sumitomo	Walter	Kyocera	Taegutec	Korloy	Ceratizit
Mat.	Operations													
STEEL	Fine Finishing	FS	UM	UF	SF	F1, MF2	01	FV, SMG	FC, FW	PF2	CF, CK	FA	HFP	F32
	Finishing	FS, FP	R/L-K, PF, XF, UF	11, GM, LF	PF, SM, 14, 17, 19, XL	FF1, F2, M3, MF2	PSF, PF, SS, PS, PSS, TS	FP, FV, SV, LP	FP, FZ, LU, FK, SS, SC, SU, SK, SF	PF5, PF4, PS5	CQ, GK, GP, HQ, XP, XQ	FG, GF	VF, VL, F	SF, SMF, SMQ
	Finishing Wiper	FW*	WF	FW	WF	W-F1	TSW, W08	SW	LUW, SDW	PF				
	Finishing to Medium	MP	PM	MF, MP, GM, MR	DT, HQ	MF2	PM, 23, 24, RS	MP, MV	SU, UM, UJ	PM5	VF, MF	MT, PC	HMP, C25, M, CMX	SM
	Finishing to Medium Wiper	MW*	WM	MW	WG			MW		PM		WT		
STAINLESS STEEL	Fine Finishing	FS	UM	LF, GM	SM	F1, MF2, FF1	PSF	FJ	FC	PF2	GQ, GF	FG	HFP	
	Finishing	FS, FM, LM	MF, UF, R/L-K	MF	PF, 14	F2, M3	SS, PSS	FM, FV, SV	SU	PF4	MQ	FA	VF, F	SF, SMF, SMQ
	Finishing Wiper	FW*	WF	FW	WF	W-F1		SW		PF				
	Finishing to Medium	MM, LM	MM, XM	MF, MP	SM	MF2, M5	PM	MM, MV	UM	PM5	XQ, VF	MT, PC	HMP, C25, M	F23, F43, SM
	Finishing to Medium Wiper	MW*	WM	MW	WG			MW		PM		WT		
CAST IRON	Finishing	FK	KF	11	PF	M3		FV	SK		GK	FA	HMP	SF
	Finishing Wiper	FW*	WF	FW	PF	W-F1		SW	LUW	PF		MT, PC		
	Finishing to Medium	MK, FLAT	KM, KR	MF, MP, FLAT	PM5, 19, FLAT	M5	CM, FLAT	MV, MK, FLAT	UM, FLAT	PM5, PS5	FLAT	FALT	C25, HMP, FLAT	25P, 27, 29
	Finishing to Medium Wiper	MW*	WM	MW		W-F2		MW		PM		WT		
ALUMINIUM	Medium	LN	AL	HP, GT	AF, AS	AL	AL, PP	AZ, R/L-F	AG, AX, AY	PF2, PM2	AH, A3	FL	AK, AR	23P, 25P, 27
HRSA	Fine Finishing	FS	UM	LF	SM	F1, MF2	PSF, PF, SS, PS, PSS, TS	FJ	FC	PF2	GQ		HFP	SF
	Finishing	FM, LM	MF, UF, R/L-K	GM	PF, 14	F1	PSS, PS	FV	FX, FY	PF4	MQ	FA	HFP	F23, F43, SM
	Finishing Wiper	FW*	WF	FW	WF					PF				
	Finishing to Medium	MM, LM	MM, XM	MF	SM		PM	MV	SI	PM5	MQ	FG	HMP	SM, 25P, 29
	Finishing to Medium Wiper	MW*	WM	MW	WG					PM				
Medium to Roughing	GS													

CHIP BREAKER SPECIFICATIONS

NEGATIVES | NEGATIVAS | NEGATIVAS

Insert Type	Application	Tolerance Class	Major field of Application	Geometry	Cutting Edge*		Cutting Conditions**		Available Shapes								
					at the nose radius	at the flank	Feed Fn (mm/rev)	Depth of cut DOC (mm)	KN __	CN __	DN __	RN __	SN __	TN __	VN __	WN __	
									55°	80°	55°		90°	60°	35°	80°	
Knux's	Finishing	U	P M K	01			0,20 to 0,35	1,00 to 6,00									
	Medium	U	P M K	02			0,40 to 0,70	1,50 to 6,00									
NEGATIVES - double side	Medium Finishing	M	P M	01			0,12 to 0,50	1,00 to 6,50									
	Roughing to Medium	M	P M	02			0,14 to 0,50	0,70 to 5,00									
	Medium Finishing	M	P M	03			0,15 to 0,50	0,80 to 6,00									
		M	P M	MF			0,05 to 0,60	0,10 to 2,50									
	Medium Finishing	M	M N S	MS			0,10 to 0,80	0,20 to 4,50									
	Medium Finishing		M S	NEW GS			0,10 to 0,60	0,40 to 2,00									
	Medium Finishing	M	M S	SF			0,10 to 0,55	0,60 to 3,00									
	Medium Finishing	M	P	LC			0,07 to 0,50	0,60 to 3,00									
	Medium Finishing	M	K	ST			0,10 to 0,50	0,15 to 10,50									
	Medium Finishing	M	P	MR			0,10 to 0,70	0,30 to 9,00									

* T-Land varies according to the IC (IC reference used: 12,7mm)
 ** Cutting Conditions varies according to the Insert shape, IC and Nose Radius

NEGATIVES | NEGATIVAS | NEGATIVAS

Insert Type	Application	Tolerance Class	Major field of Application	Geometry	Cutting Edge*		Cutting Conditions**		Available Shapes							
					at the nose radius	at the flank	Feed Fn (mm/rev)	Depth of cut DOC (mm)	KN __	CN __	DN __	RN __	SN __	TN __	VN __	WN __
NEGATIVES - double side	Medium Finishing	M	P	PM			0,10 to 0,60	0,30 to 9,00								
	Medium Finishing	M	K	Flat			0,08 to 2,50	0,10 to 15,00								
	Medium Wiper	M	P M K	MW			0,15 to 0,90	0,30 to 6,00								
	Roughing to Medium roughing	M	M S	SS			0,10 to 1,00	0,30 to 8,50								
	Roughing to Medium roughing	M	P NEW	MA			0,30 to 0,70	1,20 to 8,00								
	Roughing	M	P M K	HR			0,20 to 1,20	0,80 to 15,00								
NEGATIVES - Single side	Roughing to Medium roughing	M	P NEW	GR			0,20 to 1,50	0,80 to 8,00								
	Roughing	M	P M	RP			0,30 to 1,50	2,00 to 12,00								
	Heavy Roughing to Roughing	M	P M	HY			0,35 to 1,60	2,00 to 15,00								
	Heavy Roughing	M	P K	HZ			0,35 to 1,60	2,40 to 17,00								

* T-Land varies according to the IC (IC reference used: 12,7mm)

** Cutting Conditions varies according to the Insert shape, IC and Nose Radius

CHIP BREAKER SPECIFICATIONS

POSITIVES | POSITIVAS | POSITIVAS

Insert Type	Application	Tolerance Class	Major field of Application	Geometry	Cutting Edge*		Cutting Conditions**		Available Shapes							
					at the nose radius	at the flank	Feed F _n (mm/rev)	Depth of cut DOC (mm)	CC __	DC __	RC __	SC __	TC __	VC __	VB __	
									80°	55°		90°	60°	35°	35°	
POSITIVES - Clearance angle 5° and 7°	Fine Finishing	M	P	FP			0,03 to 0,45	0,06 to 2,40								
		M	P M	BO			0,05 to 0,30	0,30 to 1,50								
		M	M S	FM			0,03 to 0,45	0,06 to 2,40								
		M	K	FK			0,03 to 0,30	0,06 to 2,40								
	Fine Finishing wiper	M	P M K S	FW			0,05 to 0,50	0,30 to 3,50								
		M	M S	LM			0,08 to 0,35	0,20 to 3,00								
	Finishing	Finishing to fine finishing	G	P M S	FS			0,01 to 0,25	0,10 to 3,00							
			G	N	LN			0,05 to 1,60	0,05 to 7,00							
	Medium	Medium	M	K	Flat			0,04 to 0,80	0,05 to 6,30							
			M	P	MP			0,06 to 0,60	0,19 to 3,60							
			M	M S	MM			0,06 to 0,60	0,19 to 3,60							
			M	K	MK			0,06 to 0,60	0,19 to 3,60							

* T-Land varies according to the IC (IC reference used: 12,7mm)
 ** Cutting Conditions varies according to the Insert shape, IC and Nose Radius

POSITIVES | POSITIVAS | POSITIVAS

Insert Type	Application	Tolerance Class	Major field of Application	Geometry	Cutting Edge*		Cutting Conditions**		Available Shapes							
					at the nose radius	at the flank	Feed F _n (mm/rev)	Depth of cut DOC (mm)	CC __	DC __	RC __	SC __	TC __	VC __	VB __	
									80°	55°		90°	60°	35°	35°	
POSITIVES - Clearance angle 5° and 7°	Finishing Wiper	M	P M K S	MW			0,10 to 0,50	0,50 to 4,00								
	Medium	M	P M S	CP			0,04 to 0,17	0,50 to 2,40								
	Medium to finishing		P M	RF			0,25 to 2,50	2,50 to 10,00								
	Roughing to Medium		M	P M K	ST			0,05 to 3,20	0,80 to 12,80							
				P M K	RM			0,80 to 2,50	3,20 to 13,00							
				P M	RR			0,80 to 2,50	3,20 to 13,00							
Medium to Roughing	M	M S	GS			0,05 to 4,00	0,40 to 5,00									

* T-Land varies according to the IC (IC reference used: 12,7mm)
 ** Cutting Conditions varies according to the Insert shape, IC and Nose Radius

Insert Type	Application	Tolerance Class	Major field of Application	Geometry	Cutting Edge*		Cutting Conditions**		Available Shapes	
					at the nose radius	at the flank	Feed F _n (mm/rev)	Depth of cut DOC (mm)	CC __	DC __
									80°	55°
POSITIVES - Clearance angle 11°	Medium to Finishing	U	P M K S	Flat			0,05 to 2,20	1,00 to 10,00		
	Finishing to Fine Finishing	M	P M K	12			0,03 to 0,55	0,10 to 3,00		
	Medium	M	P M	13			0,03 to 0,55	0,20 to 7,00		

* T-Land varies according to the IC (IC reference used: 12,7mm)
 ** Cutting Conditions varies according to the Insert shape, IC and Nose Radius

ISO	Material	Grade fn (mm/r) HB (brinell)	CVD Coating														
			← Wear Resistance												Toughness →		
			PHG105			PH5115			PHG115			PH5125			PHG125		
			0.2	0.4	0.8	0.2	0.4	0.8	0.2	0.4	0.8	0.2	0.4	0.8	0.2	0.4	0.8
P	Unalloyed steel	125-170	280-380	210-300	200-250	240-340	170-260	160-210	250-350	180-270	170-220	190-285	160-230	140-205	200-295	170-240	150-215
	Low-alloy steel	180-350	220-280	200-260	170-210	180-240	160-220	130-170	190-250	170-230	140-180	160-220	130-200	110-180	170-230	140-210	120-190
	High-alloy stel	200-325	165-250	150-235	140-230	125-210	110-195	100-190	135-220	120-205	110-200	115-205	100-175	90-160	125-215	110-185	100-170
P	Material	Grade fn (mm/r) HB (brinell)	CVD Coating						PVD Coating								
			← Wear Resistance						Toughness →			← Wear Resistance			Toughness →		
			PHG140			PH5740			PH7910			PH7920					
			0.2	0.4	0.8	0.2	0.4	0.8	0.2	0.4	0.8	0.2	0.4	0.8			
P	Unalloyed steel	125-170	135-230	120-210	115-200	125-220	110-200	105-190	140-245	130-225	115-220	130-230	120-220	110-210			
	Low-alloy steel	180-350	125-205	105-185	95-185	115-195	95-175	85-175	130-230	125-225	125-215	125-220	115-210	100-200			
	High-alloy stel	200-325	105-205	75-175	50-135	95-195	65-165	40-125	-	-	-	-	-	-			

ISO	Material	Grade fn (mm/r) HB (brinell)	CVD Coating											
			← Wear Resistance							Toughness →				
			PHS215			PHS225			PHS240					
			0.2	0.4	0.6	0.2	0.4	0.6	0.2	0.4	0.6			
M	SS - Ferritic/martensitic	200-330	125-260	100-220	80-200	115-230	90-180	70-160	110-230	85-175	70-140			
	SS - Austenitic	180-330	120-255	95-215	75-195	110-225	85-175	65-155	105-225	80-170	65-135			
	SS - Austenitic-ferritic (Duplex)	230-260	110-245	85-205	65-185	100-215	75-165	55-145	95-215	70-160	55-125			
M	Material	Grade fn (mm/r) HB (brinell)	PVD Coating											
			← Wear Resistance									Toughness →		
			PH7910			PHH910			PH7920			PHH920		
			0.2	0.4	0.6	0.2	0.4	0.6	0.2	0.4	0.6	0.2	0.4	0.6
M	SS - Ferritic/martensitic	200-330	120-220	110-210	105-205	130-230	120-220	115-215	110-210	100-200	95-195	120-220	110-210	105-205
	SS - Austenitic	180-330	115-215	105-205	95-195	125-225	115-215	105-205	105-205	95-195	85-185	115-215	105-205	95-195
	SS - Austenitic-ferritic (Duplex)	230-260	105-202	100-195	90-185	115-212	110-205	100-195	95-192	90-185	80-175	105-202	100-195	90-185

ISO	Material	Grade fn (mm/r) HB (brinell)	CVD Coating								
			← Wear Resistance						Toughness →		
			PH5705			PH5320			PH5740		
			0.2	0.4	0.6	0.2	0.4	0.6	0.2	0.4	0.6
K	Marble cast iron	130-230	160-360	140-280	120-235	150-330	130-240	110-220	110-230	100-215	100-190
	Grey cast iron	180-220	220-380	190-330	150-290	200-330	170-280	150-230	150-230	140-220	110-210
	Nodular cast iron	160-380	150-280	135-265	120-220	140-250	125-230	110-220	125-220	115-205	105-185

ISO	Material	Grade fn (mm/r) HB (brinell)	Uncoated	
			PH0910	
			0.15	0.8
N	Aluminium alloys	60-130	375-2400	40-240
	Cooper and cooper alloys	90-110	375-630	35-65

ISO	Material	Grade fn (mm/r) HB (brinell)	PVD Coating											
			← Wear Resistance									Toughness →		
			PH7910			PHH910			PH7920			PHH920		
			0.1	0.3	0.5	0.2	0.4	0.6	0.1	0.3	0.5	0.2	0.4	0.6
S	Heat resistant super alloys (Iron base)	200-280	65-140	60-130	50-110	75-150	70-140	60-120	60-135	55-125	45-105	70-145	65-135	55-115
	Heat resistant super alloys (Nickel base)	250-320	45-120	40-110	30-100	55-130	50-120	40-110	40-115	35-105	25-95	50-125	45-115	35-105
	Heat resistant super alloys (Cobalt base)	200-320	45-115	40-105	30-90	55-125	50-115	40-100	40-110	35-100	25-85	50-120	45-110	35-95
	Titanium alloys (400<-or<-1050[MPa])	-	50-130	45-120	40-100	60-140	55-130	50-110	45-125	40-115	35-95	55-135	50-125	45-105

SELECTION GUIDE (GRADES AND CHIP-BREAKERS) FOR NEGATIVE INSERTS

Guia De Seleção (Graus E Quebra-Aparas) para pastilhas negativas | Guía De Selección (Calidades Y Rompevirutas) para plaquitas negativas

SELECTION GUIDE FOR NEGATIVE INSERTS - SINGLE SIDE ...NMM'S

ISO	Material workplace	Stability	Medium		Roughing		Medium roughing		Insert			Holders
			Chip-breaker	Grade	Chip-breaker	Grade	Chip-breaker	Grade	Type		Type	
P	Unalloy steel HB 110 DIN C15 C45		RP	PH5125 PHG125	RP	PH5125 PHG125	HZ	PH5125 PHG125	 0°	Conventional Nose Radius	#NMM	D##N M##N M##N-K
			RP	PH5125 PHG125	HY	PH5125 PHG125	HZ	PH5125 PHG125				
			RP	PH5125 PHG125	HY	PH5740 PHG140	HZ	PH5740 PHG140				
	Low Alloyed Steel HB180 DIN 21NiCrM02 36CrNiM04		RP	PH5125 PHG125	RP	PH5125 PHG125	HZ	PH5125 PHG125	 0°	Conventional Nose Radius	#NMM	D##N M##N M##N-K
			RP	PH5125 PHG125	HY	PH5125 PHG125	HZ	PH5125 PHG125				
			RP	PH5125 PHG125	HY	PH5125 PHG125	HZ	PH5125 PHG125				
	High alloyed steel HB 200 DIN 34CrNiMo6 42CrMo4		RP	PH5125 PHG125	RP	PH5125 PHG125	HZ	PH5125 PHG125	 0°	Conventional Nose Radius	#NMM	D##N M##N M##N-K
			RP	PH5125 PHG125	HY	PH5125 PHG125	HZ	PH5125 PHG125				
			RP	PH5125 PHG125	HZ	PH5740 PHG140	HZ	PH5740 PHG140				
	High alloyed steel HB 400 DIN X40CrMoV5 X45GrSi93		RP	PH5125 PHG125	RP	PH5125 PHG125	HZ	PH5125 PHG125	 0°	Conventional Nose Radius	#NMM	D##N M##N M##N-K
			RP	PH5125 PHG125	HY	PH5125 PHG125	HZ	PH5125 PHG125				
			RP	PH5125 PHG125	HZ	PH5125 PHG125	HZ	PH5125 PHG125				
M	Ferritic/ martensitic stainless steel DIN X12CrMoS17 X6CrMo17		RP	PHS225	RP	PHS225	HY	PHS225	 0°	Conventional Nose Radius	#NMM	D##N M##N M##N-K
			RP	PHS225	HY	PHS225	HY	PHS225				
			RP	PHS225	HY	PHS240	HY	PHS240				
	Austenitic stainless steel DIN X5CrNi189 X5CrNiMo18		RP	PHS225	RP	PHS225	HS	PHS225	 0°	Conventional Nose Radius	#NMM	D##N M##N M##N-K
			RP	PHS225	RP	PHS225	HY	PHS225				
			RP	PHS225	HY	PHS240	HY	PHS240				
	Duplex stainless steel DIN X2CrNiMoSi19 X8CrNiMo27		RP	PHS225	RP	PHS225	HY	PHS225	 0°	Conventional Nose Radius	#NMM	D##N M##N M##N-K
			RP	PHS225	RP	PHS225	HY	PHS240				
			RP	PHS225	HY	PHS240	HY	PHS240				
K	Grey cast iron HB 220 DIN GG15 GG25 GG35		HZ	PH5320	HZ	PH5320	HY	PH5125	 0°	Conventional Nose Radius	#NMM	D##N M##N M##N-K
			HZ	PH5320	HZ	PH5320	HY	PH5125				
			HZ	PH5740	HZ	PH5740	HY	PH5740				
	Nodular cast iron HB 180 DIN GGG40 GGG50 GGG70		HZ	PH5320	HZ	PH5320	HY	PH5125	 0°	Conventional Nose Radius	#NMM	D##N M##N M##N-K
			HZ	PH5740	HZ	PH5740	HY	PH5125				
			HZ	PH5740	HZ	PH5740	HY	PH5740				

Stable cutting

General cutting

Unstable cutting

TURNING
Insert selection
Overview
Negative inserts
Positive inserts
PCBN & PCD inserts
Heavy turning
External Toolholders
Internal Toolholders
Automatic Lathes
Spare Parts
Technical Data

SELECTION GUIDE (GRADES AND CHIP-BREAKERS) FOR NEGATIVE INSERTS

SELECTION GUIDE FOR NEGATIVE INSERTS - DOUBLE SIDE ...NMG'S

ISO	Material workplace	Stability	Medium		Roughing		Medium roughing		Insert			Holders
			Chip-breaker	Grade	Chip-breaker	Grade	Chip-breaker	Grade	Type		Type	
P	Unalloyed steel HB 110 DIN C15 C45 C60		MF	PH5115 PHG115	LC	PH5115 PHG115	MR PM	PH5115 PHG115	Negative double side 	Conventional Nose Radius 	#NMG	D##N M##N M##N-K P##N
			MF	PH5115 PHG115	LC	PH5125 PHG125	MR PM	PH5125 PHG125				
			MF	PH5125 PHG125	LC	PH5125 PHG125	MR	PH5125 PHG125	0° 			
			MW	PH5115 PHG115	MW	PH5115 PHG115	MW	PH5115 PHG115				
			MW	PH5115 PHG115	MW	PH5115 PHG115	MW	PH5115 PHG115	0° 	Wiper Nose Radius 	CNMG WNMG	D##N 95° M##N 95° M##N-K 95° P##N 95°
			MW	PH5125 PHG125	MW	PH5125 PHG125	MW	PH5125 PHG125				
	Low alloyed Steel HB 180 DIN 21NiCrMo2 36CrNiMo4 34CrMo4		MF	PH7910	MR PM	PH5115 PHG115	HR	PH5115 PHG115	Negative double side 	Conventional Nose Radius 	#NMG	D##N M##N M##N-K P##N
			MF	PH5115 PHG115	MR PM	PH5125 PHG125	HR	PH5125 PHG125				
			MF	PH5125 PHG125	MR / PM	PH5125 PHG125	HR	PH5125 PHG125	0° 			
			MW	PH5115 PHG115	MW	PH5115 PHG115	MW	PH5115 PHG115				
			MW	PH5115 PHG115	MW	PH5115 PHG115	MW	PH5115 PHG115	0° 	Wiper Nose Radius 	CNMG WNMG	D##N 95° M##N 95° M##N-K 95° P##N 95°
			MW	PH5125 PHG125	MW	PH5125 PHG125	MW	PH5125 PHG125				
	High alloyed steel HB 200 DIN 34CrNiMo6 42CrMo4		MF	PH7910	MR / PM	PH5115 PHG115	HR	PH5115 PHG115	Negative double side 	Conventional Nose Radius 	#NMG	D##N M##N M##N-K P##N
			MF	PH5115 PHG115	MR / PM	PH5125 PHG125	HR	PH5125 PHG125				
			MF	PH5125 PHG125	MR / PM	PH5125 PHG125	HR	PH5125 PHG125	0° 			
			MW	PH5115 PHG115	MW	PH5115 PHG115	MW	PH5115 PHG115				
			MW	PH5115 PHG115	MW	PH5115 PHG115	MW	PH5115 PHG115	0° 	Wiper Nose Radius 	CNMG WNMG	D##N 95° M##N 95° M##N-K 95° P##N 95°
			MW	PH5125 PHG125	MW	PH5125 PHG125	MW	PH5125 PHG125				
	High alloyed steel HB 400 DIN X40CrMoV5 X45GrS193		MF ST	PH7910 PH5705	MR PM	PH5115 PHG115	HR	PH5115 PHG115	Negative double side 	Conventional Nose Radius 	#NMG	D##N M##N M##N-K P##N
			MF ST	PH5115 PHG115 PH5320 PHG105	MR PM	PH5115 PHG115	HR	PH5115 PHG115				
			MF	PH5115 PHG115	MR PM	PH5125 PHG125	HR	PH5125 PHG125	0° 			
			MW	PH5115 PHG115	MW	PH5115 PHG115	MW	PH5115 PHG115				
			MW	PH5115 PHG115	MW	PH5115 PHG115	MW	PH5115 PHG115	0° 	Wiper Nose Radius 	CNMG WNMG	D##N 95° M##N 95° M##N-K 95° P##N 95°
			MW	PH5115 PHG115	MW	PH5115 PHG115	MW	PH5125 PHG125				
M	Ferritic/ martensitic stainless steel DIN X12CrMoS17 X6CrMo17		SF, GS	PH7920 PHH920	SS	PH7920	HR	PHS225	Negative double side 	Conventional Nose Radius 	#NMG	D##N M##N M##N-K
			SF, GS	PH7920 PHH920	SS	PH7920	HR	PHS225				
			SF, GS	PH7920 PHH920	SS	PH7920	HR	PHS240	0° 			
			MW	PHS215	MW	PHS215	-	-				
			MW	PHS215	MW	PHS215	-	-	0° 	Wiper Nose Radius 	CNMG WNMG	D##N 95° M##N 95° M##N-K 95° P##N 95°
			MW	PHS225	MW	PHS240	-	-				

Stable cutting

General cutting

Unstable cutting

DOUBLE SIDE ...NMG'S

ISO	Material workplace	Stability	Medium		Roughing		Medium roughing		Insert			Holders
			Chip-breaker	Grade	Chip-breaker	Grade	Chip-breaker	Grade	Type			Type
M	Austenitic stainless steel		GS, SF	PH7920 PHH910	SS	PH7920	HR	PHS225	Negative double side	Conventional Nose Radius	#NMG	D##N M##N M##N-K P##N
			GS, GS	PH7910 PHH7920	SS	PH7920	HR	PHS225				
			GS, SF	PH7920 PHH920	SS	PH7920	HR	PHS240				
			MW	PHS215	MW	PHS215	-	-	Negative double side	Wiper Nose Radius	CNMG WNMG	D##N 95° M##N 95° M##N-K 95° P##N 95°
			MW	PHS215	MW	PHS225	-	-				
			MW	PHS225	MW	PHS240	-	-			0°	
	Duplex stainless steel		GS, SF	PH7920 PHH920	SS	PH7910	HR	PHS225	Negative double side	Conventional Nose Radius	#NMG	D##N M##N M##N-K P##N
			GS, SF	PH7920 PHH920	SS	PH7920	HR	PHS225				
			GS, SF	PH7920 PHH920	SS HR	PHS240	HR	PHS240				
			MW	PHS215	-	-	-	-	Negative double side	Wiper Nose Radius	CNMG WNMG	D##N 95° M##N 95° M##N-K 95° P##N 95°
			-	-	-	-	-	-				
			-	-	-	-	-	-			0°	
K	Grey cast iron		Flat	PH5705	Flat	PH5320	HR	PH5705	Negative double side	Conventional Nose Radius	#NMG	D##N M##N M##N-K P##N
			ST	PH5320	ST	PH5705	HR	PH5705				
			ST	PH5320	ST	PH5320	HR	PH5320				
			MW	PH5320	MW	PH5320	-	-	Negative double side	Wiper Nose Radius	CNMG WNMG	D##N 95° M##N 95° M##N-K 95° P##N 95°
			MW	PH5320	MW	PH5320	-	-				
			MW	PH5320	MW	PH5320	-	-			0°	
	Nodular cast iron		Flat	PH5705	ST	PH5705	HR	PH5705	Negative double side	Conventional Nose Radius	#NMG	D##N M##N M##N-K P##N
			ST	PH5320	ST	PH5320	HR	PH5320				
			ST	PH5320	ST	PH5320	HR	PH5320				
			MW	PH5320	MW	PH5320	-	-	Negative double side	Wiper Nose Radius	CNMG WNMG	D##N 95° M##N 95° M##N-K 95° P##N 95°
			MW	PH5320	MW	PH5320	-	-				
			MW	PH5320	MW	PH5320	-	-			0°	
S	Titanium Alloys		GS, SF	PH7910 PHH910	MS	PH7910 PHH910	SS	PH7920	Negative double side	Conventional Nose Radius	#NMG	D##N M##N M##N-K P##N
			GS, SF	PH7910 PHH910	MS	PH7910 PHH910	SS	PH7920				
			GS, SF	PH7910 PHH910	MS	PH7910 PHH910	SS	PH7920				

Stable cutting

General cutting

Unstable cutting

SELECTION GUIDE (GRADES AND CHIP-BREAKERS) FOR NEGATIVE INSERTS

Guia De Seleção (Graus E Quebra-Aparas) para pastilhas negativas | Guía De Selección (Calidades Y Rompevirutas) para plaquitas negativas

DOUBLE SIDE ...NMG'S

ISO	Material Workplace	Stability	Medium		Roughing		Medium roughing		Insert			Holders
			Chip-breaker	Grade	Chip-breaker	Grade	Chip-breaker	Grade	Type			Type
S	Super Alloys DIN NiCr19Co11MoTi NiFe35Cr14MoTi CoCr20W15Ni		GS, SF	PH7910 PHH910	MS	PH7910 PHH910	SS	PH7920	 0°	Conventional Nose Radius	#NMG	D##N M##N M##N-K P##N
			GS, SF	PH7910 PHH910	MS SS	PH7910 PHH910	SS	PH7920				
			GS, SF	PH7910 PHH910	MS SS	PH7910 PHH910	SS	PH7920				
N	Aluminium Alloys DIN AW7075 AlSi12 CuZn37		MS	PH0910	MS	PH0910	-	-	 0°	Conventional Nose Radius	#NMG	D##N M##N M##N-K P##N
			MS	PH0910	MS	PH0910	-	-				
			MS	PH0910	MS	PH0910	-	-				

Stable cutting General cutting Unstable cutting

SINGLE SIDE...CMT'S, BMT'S, CGT'S, RCMX'S, RCMT'S

ISO	Material Workplace	Stability	Medium		Roughing		Medium roughing		Insert			Holders			
			Chip-breaker	Grade	Chip-breaker	Grade	Chip-breaker	Grade	Type			Type			
P	Unalloyed steel HB 110 DIN C15 C45 C60		FP	PH5115 PHG115	MP	PH5115 PHG115	MP	PH5115 PHG115		Conventional nose radius	#CMT #BMT	S##C S##B			
			FP	PH5115 PHG115	MP	PH5125 PHG125	MP	PH5125 PHG125							
			FP	PH5125 PHG125	MP	PH5125 PHG125	MP	PH5125 PHG125		Wiper nose radius	CCMT	S##C 95°			
			FW	PH5115 PHG115	MW	PH5115 PHG115	-	-							
			FW	PH5115 PHG115	MW	PH5115 PHG115	-	-							
			FW	PH5115 PHG115	MW	PH5115 PHG115	-	-							
		FP	PH5115 PHG115	MP	PH5115 PHG115	MP	PH5115 PHG115						Conventional nose radius	#CMT #BMT	S##C S##B
		FP	PH5115 PHG115	MP	PH5125 PHG125	MP	PH5125 PHG125								
		FP	PH5125 PHG125	MP	PH5125 PHG125	MP	PH5125 PHG125								
		FW	PH5115 PHG115	MW	PH5115 PHG115	-	-								
		FW	PH5115 PHG115	MW	PH5115 PHG115	-	-								
		FW	PH5115 PHG115	MW	PH5115 PHG115	-	-								
	High alloyed Steel HB 200 DIN 34CrNiMo6 42CrMo4		FP	PH5115 PHG115	MP	PH5115 PHG115	MP	PH5115 PHG115		Conventional nose radius	#CMT #BMT	S##C S##B			
			FP	PH5115 PHG115	MP	PH5125 PHG125	MP	PH5125 PHG125							
			FP	PH5125 PHG125	MP	PH5125 PHG125	MP	PH5125 PHG125							
			FW	PH5115 PHG115	MW	PH5115 PHG115	-	-							
			FW	PH5115 PHG115	MW	PH5115 PHG115	-	-							
			FW	PH5115 PHG115	MW	PH5115 PHG115	-	-							

Stable cutting General cutting Unstable cutting

SELECTION GUIDE (GRADES AND CHIP-BREAKERS) FOR POSITIVE INSERTS

Guia De Seleção (Graus E Quebra-Aparas) para pastilhas positivas | Guía De Selección (Calidades Y Rompevirutas) para plaquitas positivas

SINGLE SIDE...CMT'S, BMT'S, CGT'S, RCMX'S, RCMT'S

ISO	Material Workplace	Stability	Medium		Roughing		Medium roughing		Insert			Holders	
			Chip-breaker	Grade	Chip-breaker	Grade	Chip-breaker	Grade	Type			Type	
M	High alloyed Steel HB 400 DIN X40CrMoV5 X45GrSi93		FP FK	PH5115 PHG115 PH5705	MP MK	PH5115 PHG115 PH5320 PHG105	MP	PH5115 PHG115		Positive single side	Conventional nose radius	#CMT #BMT	S##C S##B
			FP FK	PH5115 PHG115 PH5320 PHG105	MP MK	PH5115 PHG115 PH5320 PHG105	MP	PH5115 PHG115					
			FP	PH5115 PHG115	MP	PH5125 PHG125	MP	PH5125 PHG125		Positive single side	Wiper nose radius	CCMT	S##C 95°
			FW	PH5115 PHG115	MW	PH5115 PHG115	-	-					
			FW	PH5115 PHG115	MW	PH5115 PHG115	-	-				DCMT TCMT	S##C 93°
			FW	PH5115 PHG115	MW	PH5115 PHG115	-	-					
M	Duplex stainless steel DIN X2CrNiMoSi19 X8CrNiMo27 X2CrNiMoN22		FM	PH7910	LM MM	PH7910	MM	PHS215		Positive single side	Conventional nose radius	#CMT #BMT	S##C S##B
			FM LM	PH7910	MM	PH7910	MM	PHS215					
			FM LM	PH7920	MM	PH7920	MM	PHS215					
			FW	PH7920	MW	PHS215	-	-		Positive single side	Wiper nose radius	CCMT	S##C 95°
			FW	PH7920	MW	PHS225	-	-					
			-	-	-	-	-	-				DCMT TCMT	S##C 93°
	Austenitic stainless steel DIN X2CrNiMoSi19 X8CrNiMo27 X2CrNiMoN22		FM LM	PH7910 PHH910	LM MM	PH7910 PHH910	MM	PHS215		Positive single side	Conventional nose radius	#CMT #BMT	S##C S##B
			FM LM	PH7920 PHH920	MM	PH7920 PHH920	MM	PHS215					
			FM LM	PHS225	MM	PHS215	MM	PHS215					
			MW	PH7920	MW	PH7920	-	-		Positive single side	Wiper nose radius	CCMT	S##C 95°
			MW	PHS215	MW	PHS215	-	-					
			MW	PHS215	MW	PHS215	-	-				DCMT TCMT	S##C 93°
	Duplex stainless steel DIN X2CrNiMoSi19 X8CrNiMo27 X2CrNiMoN22		FM LM	PH7910 PHH910	LM MM	PH7910 PHH910	MM	PHS215		Positive single side	Conventional nose radius	#CMT #BMT	S##C S##B
			FM LM	PH7910	MM	PH7910	MM	PHS215					
			FM LM	PHS225	MM	PHS215	MM	PHS215					
			-	-	-	-	-	-		Positive single side	Wiper nose radius	CCMT	S##C 95°
			-	-	-	-	-	-					
			-	-	-	-	-	-				DCMT TCMT	S##C 93°

Stable cutting

General cutting

Unstable cutting

SELECTION GUIDE (GRADES AND CHIP-BREAKERS) FOR POSITIVE INSERTS

Guia De Seleção (Graus E Quebra-Aparas) para pastilhas positivas | Guía De Selección (Calidades Y Rompevirutas) para plaquitas positivas

SINGLE SIDE ...CMT'S, BMT'S, CGT'S, RCMX'S, RCMT'S

ISO	Material Workplace	Stability	Medium		Roughing		Medium roughing		Insert			Holders
			Chip-breaker	Grade	Chip-breaker	Grade	Chip-breaker	Grade	Type		Type	
K	Grey cast iron HB 220 DIN GG15 GG25 GG35	●	FK	PH5705	MK	PH5705	MK	PH5705	Positive single side 	Conventional nose radius 	#CMT #BMT	S##C S##B
			FK	PH5705	MK	PH5705	MK	PH5320				
		✖	MK	PH5320	MK	PH5320	MK	PH5320	Positive single side 	Wiper nose radius 	CCMT	S##C 95°
			FW	PH5705	MW	PH5320	-	-				
		●	FW	PH5705	MW	PH5320	-	-	Positive single side 	Wiper nose radius 	DCMT TCMT	S##C 93°
			MW	PH5320	MW	PH5320	-	-				
	Nodular Cast Iron HB 220 DIN GG15 GG25 GG35	●	FK	PH5705	MK	PH5320	MK	PH5320	Positive single side 	Conventional nose radius 	#CMT #BMT	S##C S##B
			FK	PH5705	MK	PH5320	MK	PH5320				
		✖	MK	PH5320	MK	PH5320	MK	PH5320	Positive single side 	Wiper nose radius 	CCMT	S##C 95°
			FW	PH5705	MW	PH5320	-	-				
		●	FW	PH5705	MW	PH5320	-	-	Positive single side 	Wiper nose radius 	DCMT TCMT	S##C 93°
			MW	PH5320	MW	PH5320	-	-				
S	Titanium Alloys DIN TiAl5Sn2.5 TiAl6V4 TiAl6V4ELI	●	FS	PHH910	FM	PHH910	MM	PH7920	Positive single side 	Conventional nose radius 	#CMT #BMT	S##C S##B
			FM	PH7920	MM	PH7920	MM	PH7920				
		✖	MM	PH7920	MM	PH7920	MM	PH7920	Positive single side 	Wiper nose radius 	CCMT	S##C 95°
			FW	PH7920	FW	PH7920	-	-				
		●	FW	PH7920	MW	PH7920	-	-	Positive single side 	Wiper nose radius 	DCMT TCMT	S##C 93°
			MW	PH7920	MW	PH7920	-	-				
	Super alloys DIN NiCr19Co11MoTi NiFe35Cr14MoTi CoCr20W15Ni	●	FS	PHH910	FM	PHH910	MM	PHH920	Positive single side 	Conventional nose radius 	#CMT #BMT	S##C S##B
			FM	PHH920	FM	PHH920	FM	PHH920				
		✖	MM	PHH920	MM	PHH920	MM	PHH920	Positive single side 	Wiper nose radius 	CCMT	S##C 95°
			FW	PH7920	FW	PH7920	-	-				
		●	FW	PH7920	MW	PH7920	-	-	Positive single side 	Wiper nose radius 	DCMT TCMT	S##C 93°
			MW	PH7920	MW	PH7920	-	-				
N	Aluminium Alloys DIN AW7075 AISI12 CuZn37	●	LN	PH0910	LN	PH0910	-	-	Positive single side 	Conventional nose radius 	#CMT #BMT	S##C S##B
		●	LN	PH0910	LN	PH0910	-	-				
		✖	LN	PH0910	LN	PH0910	-	-				

● Stable cutting

● General cutting

✖ Unstable cutting

TOOL LIFE PROBLEMS | Problemas na vida útil da ferramenta | Problemas con la vida útil de la herramienta

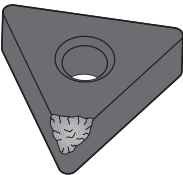
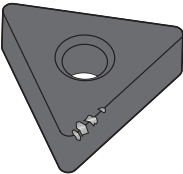
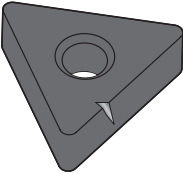
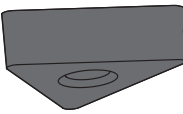
Problem Problema	Possible Solution Solução Solución		
<ul style="list-style-type: none"> • Breakage or too short tool life • Ruptura ou vida útil muito curta • Ruptura o vida de la herramienta demasiado corto 	<ul style="list-style-type: none"> • Step 1. Reduce the cutting conditions (first feed rate, then cutting depth). • Step 2. Look at the wear pattern on the insert and use the table below as a guideline for improvement. • Passo 1. Reduza as condições de corte (primeiro o avanço / rotação depois a profundidade de corte). • Passo 2. Verique o desgaste da pastilha e use as recomendações abaixo para otimizar a operação. • Paso 1. Reducir las condiciones de corte (primero el avance, después la profundidad de corte). • Paso 2. Comprobar el patrón de desgaste en la plaquita y usar la siguiente tabla como guía para la mejora. 		
<ul style="list-style-type: none"> • Insert fracture • Fratura da Pastilha • Fractura de la Plaquita 	<ul style="list-style-type: none"> • Reduce the feed rate (Fn). • Reduce the depth of cut (Ap). • Select a tougher grade (ex: P10 -> ... -> P40). • Use a more rigid toolholder. • Increase nose radius (Re). • Select a stronger chipbreaker. • Reduce the toolholder length. • Select larger shank size. • Reduza o avanço/rotação (Fn). • Reduza a profundidade de corte (Ap). • Selecione uma classe mais tenaz (ex: P10 -> ... -> P40). • Use um suporte mais rígido. • Aumente o raio de canto (Re). • Selecione um quebra- aparas mais resistente. • Reduza o comprimento do suporte. • Escolha uma largura de haste superior. • Reducir el avance (Fn). • Reducir la profundidad de corte (Ap). • Seleccionar una calidad más tenaz (ex: P10 -> ... -> P40). • Utilice un portaherramientas más rígido. • Aumente el radio de punta (Re). • Seleccionar un rompevirutas más robusto. • Reducir la longitud del portaherramientas. • Elija un ancho de vara superior. 		
<ul style="list-style-type: none"> • Edge chipping • Fragmentação da aresta • Fragmentación de la arista 	<ul style="list-style-type: none"> • Increase the cutting speed (Vc). • Reduce the feed rate (Fn). • Select a stronger chipbreaker. • Select a tougher grade (ex: P10 -> ... -> P40). • Reduce the rake angle. • Increase honing edges. • Reduce the toolholder length. • Select larger shank size. • Aumente a velocidade de corte (Vc). • Reduza o avanço/rotação (Fn). • Selecione um quebra- aparas mais resistente. • Selecione uma classe mais tenaz (ex: P10 -> ... -> P40). • Diminua o ângulo de ataque. • Aumente arestas boleadas. • Reduza o comprimento do suporte. • Escolha uma largura de haste superior. • Reducir el ángulo de ataque. • Aumentar aristas redondeadas. • Reducir la longitud del portaherramientas. • Elija un ancho de vara superior. • Aumentar la velocidad de corte (Vc). • Reducir el avance (Fn). • Seleccionar un rompevirutas más robusto. • Seleccionar una calidad más tenaz (ex: P10 -> ... -> P40). 		
<ul style="list-style-type: none"> • Notch wear • Desgaste de entalhe • Mellado 	<ul style="list-style-type: none"> • Reduce the cutting speed (Vc). • Reduce the feed rate (Fn). • Select a tool with a smaller setting angle (Kr°). • Select a more wear-resistant grade (ex: P40 -> ... -> P10). • Reduza a velocidade de corte (Vc). • Reduza o avanço/rotação (Fn). • Selecione uma ferramenta com um ângulo de posição menor (Kr°). • Selecione uma classe mais resistente ao desgaste (ex: P40 -> ... -> P10). • Reducir la velocidad de corte (Vc). • Reducir el avance (Fn). • Seleccionar una herramienta con un ángulo de posición menor (Kr°). • Seleccionar una calidad más resistente al desgaste (ex: P40 -> ... -> P10). 		
<ul style="list-style-type: none"> • Plastic deformation • Deformação plástica • Deformación plástica 	<ul style="list-style-type: none"> • Reduce the cutting speed (Vc). • Reduce the feed rate (Fn). • Select a more wear-resistant grade (ex: P40 -> ... -> P10). • Use more coolant and correct it volume/accuracy. • Choose grade with better heat conductivity. • Increase the rake angle. • Increase nose radius (Re). • Increase relief angle. • Reduza a velocidade de corte (Vc). • Reduza o avanço/rotação (Fn). • Selecione uma classe mais resistente ao desgaste (ex: P40 -> ... -> P10). • Utilize refrigeração em abundância e corrija o seu volume/precisão. • Escolha um grau com melhor condutividade térmica. • Aumente o ângulo de ataque. • Aumente o raio de canto (Re). • Aumente o ângulo de alívio superior. • Reducir la velocidad de corte (Vc). • Reducir el avance (Fn). • Seleccionar una calidad más resistente al desgaste (ex: P40 -> ... -> P10). • Usar abundante caudal de refrigerante y corregir el volumen / precisión. • Elija un grado con una mejor conductividad térmica. • Aumente el ángulo de ataque. • Aumente el radio de punta (Re). • Aumente el ángulo de alívio superior. 		

TOOL LIFE PROBLEMS | Problemas na vida útil da ferramenta | Problemas con la vida útil de la herramienta

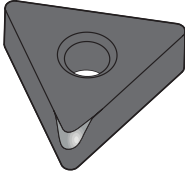
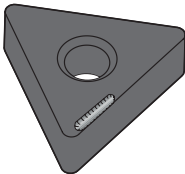
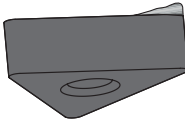
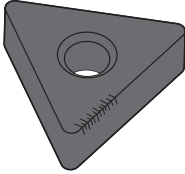
Problem Problema	Possible Solution Solução Solución		
<ul style="list-style-type: none"> • Flank wear • Desgaste do flanco • Desgaste de la superficie 	<ul style="list-style-type: none"> • Reduce the cutting speed (Vc). • Select a more wear-resistant grade (ex: P40 -> ... -> P10). • Select a toolholder or chipbreaker which allow a bigger relief angle. • Increase the rake angle. • Increase nose radius (Re). • Reduce honing edges. 	<ul style="list-style-type: none"> • Reduza a velocidade de corte (Vc). • Selecione uma classe mais resistente ao desgaste (ex: P40 -> ... -> P10). • Selecione um suporte ou quebra-apanas que permita um ângulo de alívio superior. • Aumente o ângulo de ataque. • Aumente o raio de canto (Re). • Reduza arestas boleadas. 	<ul style="list-style-type: none"> • Reducir la velocidad de corte (Vc). • Seleccionar una calidad más resistente al desgaste (ex: P40 -> ... -> P10). • Seleccionar un portaherramientas o rompevirutas que permiten un ángulo de alivio superior. • Aumente el ángulo de ataque. • Aumente el radio de punta (Re). • Reducir aristas redondeadas.
<ul style="list-style-type: none"> • Crater wear • Craterização • Craterización 	<ul style="list-style-type: none"> • Reduce the cutting speed (Vc). • Reduce the feed rate (Fn). • Select a more wear-resistant grade (ex: P40 -> ... -> P10). • Use coolant. • Increase the rake angle. • Increase nose radius (Re). 	<ul style="list-style-type: none"> • Reduza a velocidade de corte (Vc). • Reduza o avanço/rotação (Fn). • Selecione uma classe mais resistente ao desgaste (ex: P40 -> ... -> P10). • Utilize refrigeração. • Aumente o ângulo de ataque. • Aumente o raio de canto (Re). 	<ul style="list-style-type: none"> • Reducir la velocidad de corte (Vc). • Reducir el avance (Fn). • Seleccionar una calidad más resistente al desgaste (ex: P40 -> ... -> P10). • Usar refrigerante. • Aumente el ángulo de ataque. • Aumente el radio de punta (Re).
<ul style="list-style-type: none"> • Built-up edge • Aresta postiça • Recrecimiento del filo 	<ul style="list-style-type: none"> • Increase the cutting speed (Vc). • Reduce the feed rate (Fn). • Use water-insoluble coolant fluid. • Select a more easy-cutting chipbreaker. • Increase the rake angle. • Reduce honing edges. • Select grade with low tendency to adhesion. 	<ul style="list-style-type: none"> • Aumente a velocidade de corte (Vc). • Reduza o avanço/rotação (Fn). • Utilize fluido refrigerante insolúvel em água. • Selecione um quebra-apanas mais positivo. • Aumente o ângulo de ataque. • Reduza arestas boleadas. • Selecione um grau com baixa tendência a aderência. 	<ul style="list-style-type: none"> • Aumentar la velocidad de corte (Vc). • Reducir el avance (Fn). • Utilice fluido refrigerante insoluble en agua. • Seleccionar un rompevirutas de corte más suave. • Aumente el ángulo de ataque. • Reducir aristas redondeadas. • Seleccionar un grado con baja tendencia a la adhesión.
<ul style="list-style-type: none"> • Thermal cracks • Trincas térmicas • Grietas en el filo 	<ul style="list-style-type: none"> • Reduce the cutting speed (Vc). • Increase the feed rate (Fn). • Use more coolant and correct it volume/accuracy. • Reduce honing edges. • Select a tougher grade (ex: P10 -> ... -> P40). • Increase the rake angle. 	<ul style="list-style-type: none"> • Reduza a velocidade de corte (Vc). • Aumente o avanço/rotação (Fn). • Utilize refrigeração em abundância e corrija o seu volume/precisão. • Reduza arestas boleadas. • Selecione uma classe mais tenaz (ex: P10 -> ... -> P40). • Aumente o ângulo de ataque. 	<ul style="list-style-type: none"> • Reducir la velocidad de corte (Vc). • Aumentar el avance (Fn). • Usar abundante caudal de refrigerante y corregir el volumen / precisión. • Reducir aristas redondeadas. • Seleccionar una calidad más tenaz (ex: P10 -> ... -> P40). • Aumente el ángulo de ataque.

THE ANGLE POSITION (KR°)

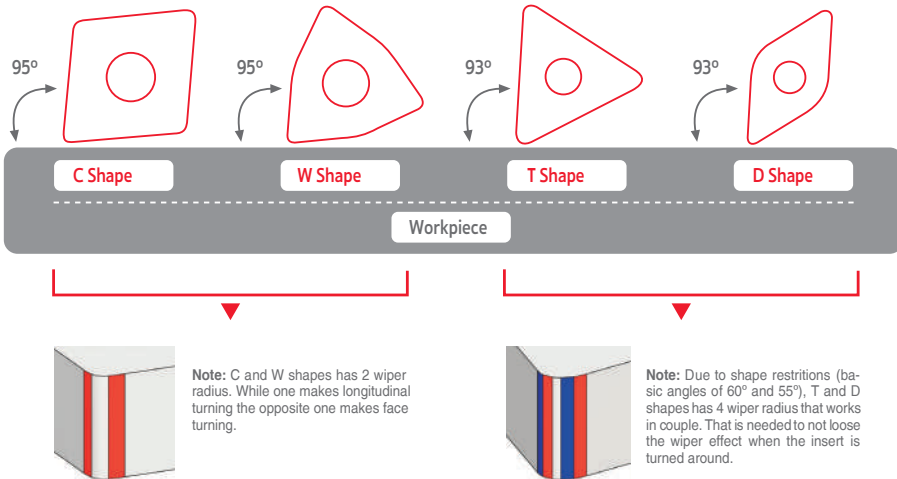

THE WIPER PURPOSE IS BASED ON PRODUCTIVITY:

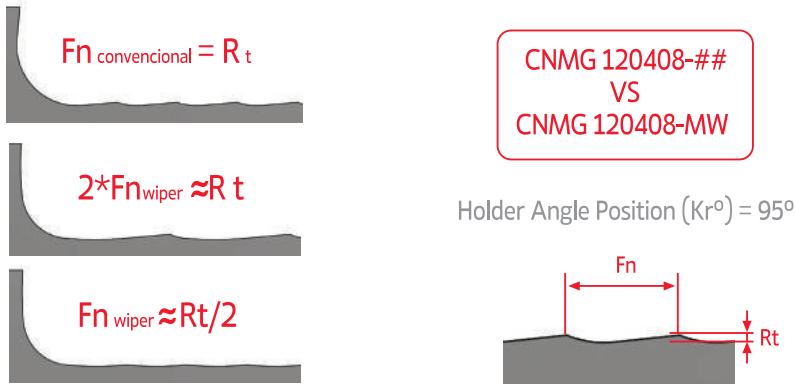

EXAMPLE CNMG 120404-MW WITH ANGLE POSITION OF 95°

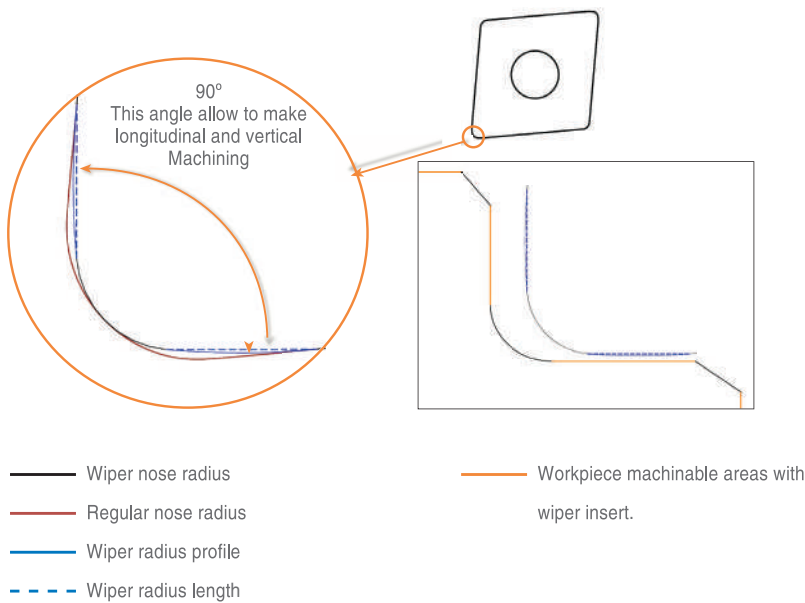

Note: wiper radius length must be parallel to machinable workpiece areas.

TURNING

Insert selection

Overview

Negative inserts

Positive inserts

PCBN & PCD inserts

Heavy turning

External Toolholders

Internal Toolholders

Automatic Lathes

Spare Parts

Technical Data



D

D - GROOVING & PARTING OFF

D - 730 | Inserts overview

D - 732 | GROOVING PLUS

D - 732 | Inserts code key

D - 733 | GP Inserts

D - 736 | Blades & Toolholders code key

D - 742 | GROOVING & PARTING OFF

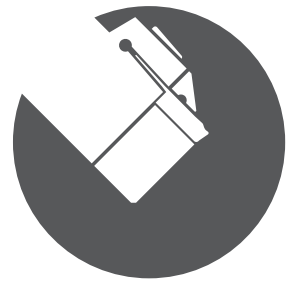

GROOVING & PARTING OFF

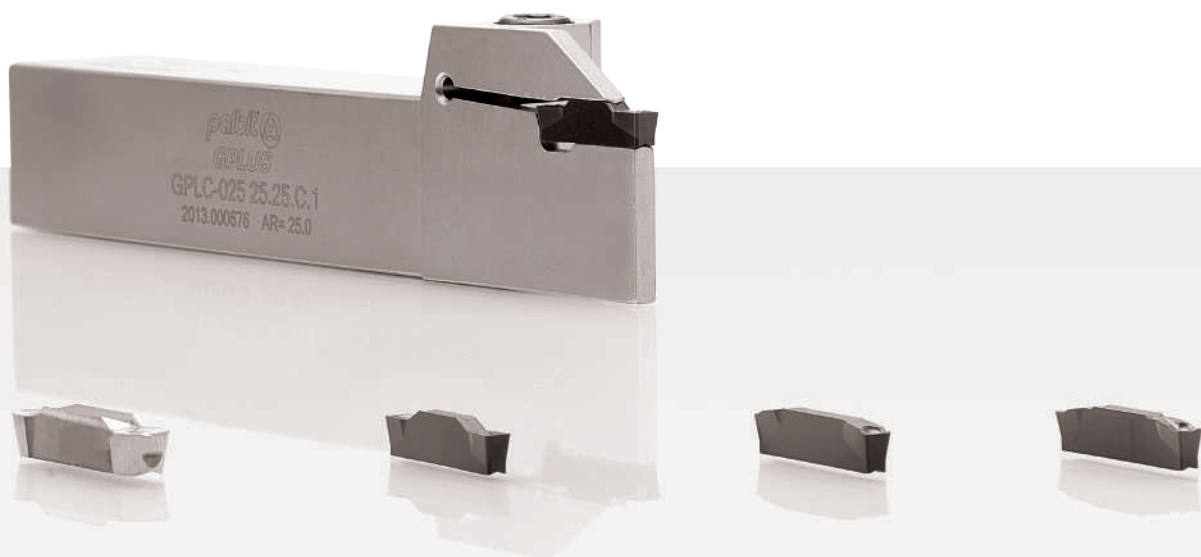

D - 742 | Inserts code key & Overview

D - 743 | Inserts

D - 747 | Blades code key

D - 751 | Trigon Inserts

D - 754 | Trigon Toolholders

D - 758 | SAL (Swiss Automatic Lathes)

D - 760 | Inserts & toolholders code key

D - 762 | Toolholders

D - 763 | Inserts

D - 766 | Technical data

D - 768 | LIGHT GROOVING











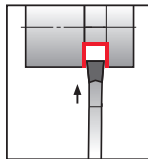
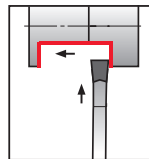
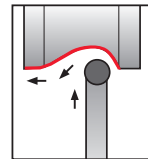

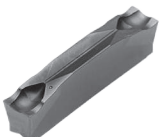
D - 772 | FORMING GROOVING

D - 776 | SPARE PARTS

D - 777 | TECHNICAL DATA











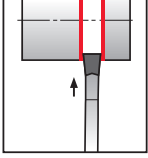
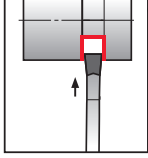
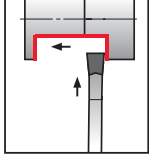
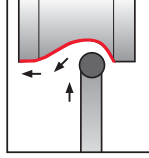
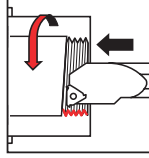





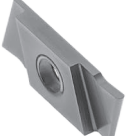

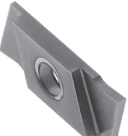
GENERAL INSERTS OVERVIEW

D
 GROOVING & PARTING OFF
 Grooving Plus
 Grooving & Parting Off
 SAL - Swiss Automatic Lathes
 Light Grooving
 Forming Grooving
 Technical Data

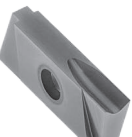
Operation Insert Type + Chipbreaker		Parting Off	General Grooving	Turning	Profiling	Threading
						
	GP...-N01-MC GP...-R01-MC GP...-L01-MC					
	GP...-N02-MC GP...-R02-MC GP...-L02-MC					
	GP...-N02-MG					
	GP...-N02-MM					
	GP...-N02-MP					
	GP...-N02-NP					
	GCMX...					
	SANCAR...					

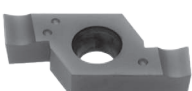
 First choice | Primeira opção | Primera opción

 Alternative | Alternativa

Insert Type + Chipbreaker		Operation		Parting Off	General Grooving	Turning	Profiling	Threading
								
	TRIGON							
	SAL GS							
	SAL GR							
	SAL P							
	SAL PT							
	SAL TP							
	LG							
	FG							

 First choice | Primeira opção | Primera opción

 Alternative | Alternativa

GP INSERTS CODE KEY

Chave de codificação para pastilhas GP | Llave de codificación para plaquitas GP

For R or L Insert type

GP	0300	B	020	-	050	R	02	-	MC
1	2	3	4		5	6	7		8

For N Insert type

GP	0300	B	020	-	N	02	-	MC
1	2	3	4		6	7		8

1 - Product Line

GP - Grooving Plus

2 - Cutting Width

0200 - 2,00mm | 0300 - 3,00mm | 0400 - 4,00mm | 0500 - 5,00mm | 0600 - 6,00mm

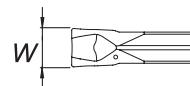

3 - Seat Size

A - GP0200 | B - GP0300 | C - GP0400 | D - GP0500 | E - GP0600

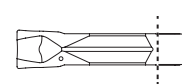

4 - Cutting Radius

020 - 0,20mm | 025 - 0,25mm | 040 - 0,40mm | 600 - 6,00mm

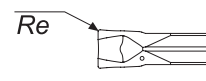

5 - Relief Angle

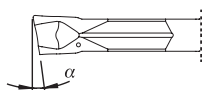

6 - Insert Type

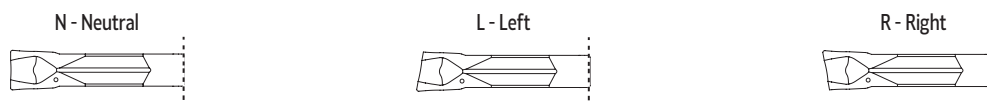

7 - Nº of Cutting Edges



8 - Chipbreaker

MC - Medium Cut Off | MG - Medium Grooving | MM - Medium Multi Function | MP - Medium Profiling | NP - Non-Ferrous Profiling

GP...02-MG | Medium Grooving

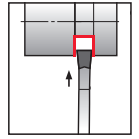
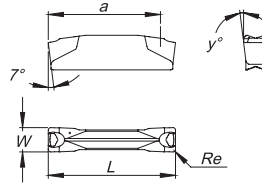

(1) Geometry code	(2) Grade code	P				M			K		S		Dimensions (mm)						Cutting Conditions			
		CVD		PVD		CVD		PVD	CVD		PVD		W	Re	L	x°	a	y°	Seat ² Size	fn (mm/r)	Min	Max
		L8	U6	G4	T1	U6	G4	T1	L6	U6	G4	T1										
1130398	GP0300B020-N02-MG	⊗	⊗	⊗	⊗	⊗	⊗	⊗	⊗	⊗	⊗	⊗	3,0	0,2	21,0	-	18,5	6,5	B	0,06	0,05	0,10
1130399	GP0400C040-N02-MG	⊗	⊗	⊗	⊗	⊗	⊗	⊗	⊗	⊗	⊗	⊗	4,0	0,4	21,0	-	18,5	6,5	C	0,08	0,05	0,15
1130400	GP0500D040-N02-MG	⊗	⊗	⊗	⊗	⊗	⊗	⊗	⊗	⊗	⊗	⊗	5,0	0,4	21,0	-	18,5	6,0	D	0,13	0,05	0,25

⊗ First choice | Primeira opção | 1ª opción
 ⊗ Stock item | Produto de stock | Itens de stock
 ○ Available under request | Disponível sobre consulta
 ⊗ Stock available until sold out | Stock disponível até acabar o stock | Stock disponible hasta acabar el stock
 2 - Correspond to a Specific Holder
 Insert order code = (1) Geometry Code + (2) Grade Code

GP...02-MM | Medium Multi Function

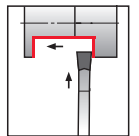
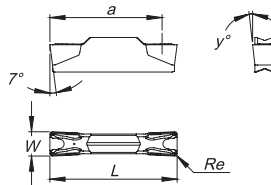

(1) Geometry code	(2) Grade code	P				M				K			S			Dimensions (mm)						Cutting Conditions					
		CVD		PVD		CVD		PVD		CVD			PVD			W	Re	L	a ¹	y°	Seat ² Size	Ap (mm)	Min	Max	fn (mm/r)	Min	Max
		U6	G4	T1	P4	U6	G4	T1	P4	L6	U6	25	G4	T1	P4												
1130401	GP0300B040-N02-MM	⊗	⊗	⊗	⊗	⊗	⊗	⊗	⊗	⊗	⊗	⊗	⊗	⊗	⊗	3,0	0,4	21,0	18,5	6,0	B	0,8	0,4	1,5	0,09	0,05	0,12
1130402	GP0400C040-N02-MM	⊗	⊗	⊗	⊗	⊗	⊗	⊗	⊗	⊗	⊗	⊗	⊗	⊗	⊗	4,0	0,4	21,0	18,5	6,0	C	1,1	0,6	2,0	0,12	0,07	0,15
1130403	GP0500D040-N02-MM	⊗	⊗	⊗	⊗	⊗	⊗	⊗	⊗	⊗	⊗	⊗	⊗	⊗	⊗	5,0	0,4	21,0	18,5	5,5	D	1,5	0,8	2,5	0,14	0,10	0,18

⊗ First choice | Primeira opção | 1ª opción
 ⊗ Stock item | Produto de stock | Itens de stock
 ○ Available under request | Disponível sobre consulta
 ⊗ Stock available until sold out | Stock disponível até acabar o stock | Stock disponible hasta acabar el stock
 1 - When using inserts with 1 Cutting edge, the "a" measure is given by the Toolholder | 2 - Correspond to a Specific Holder
 Insert order code = (1) Geometry Code + (2) Grade Code

GP...02-MP | Medium Profiling

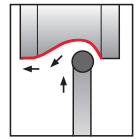
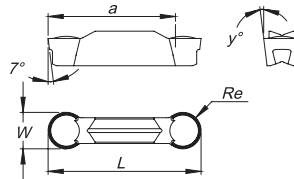

(1) Geometry code	(2) Grade code	P		M		K	S		Dimensions (mm)					Cutting Conditions						
		PVD		PVD		CVD	PVD													
		G4	T1	G4	T1	L6	G4	T1	W	Re	L	a	y°	Seat ² Size	Ap (mm)	Min	Max	fn (mm/r)	Min	Max
1130607	GP0300B150-N02-MP	⊗	⊗	⊗	⊗	⊗	⊗	⊗	3,0	1,5	21,1	18,5	7,0	B	0,7	0,04	1,1	0,09	0,04	0,12
1130404	GP0600E300-N02-MP	⊗	⊗	⊗	⊗	⊗	⊗	⊗	6,0	3,0	25,2	21,0	7,0	E	1,50	0,04	2,20	0,18	0,15	0,22

⊗ First choice | Primeira opção | 1ª opción ⊗ Stock item | Produto de stock | Itens de stock ○ Available under request | Disponível sobre consulta Insert order code = (1) Geometry Code + (2) Grade Code
 ⊕ Stock available until sold out | Stock disponível até acabar o stock | Stock disponible hasta acabar el stock Disponible bajo consulta

2 - Correspond to a Specific Holder

GP...02-NP | Non-Ferrous Profiling

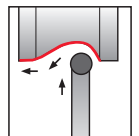
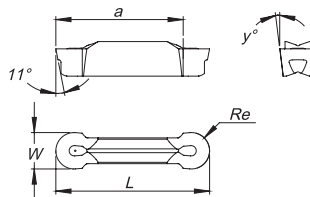

(1) Geometry code	(2) Grade code	N		Dimensions (mm)							Cutting Conditions				
		UNC	10												
		PH0910	W	Re	L	x°	a	y°	Seat ² Size	Ap (mm)	Min	Max	fn (mm/r)	Min	Max
1130405	GP0600E300-N02-NP	⊗	6,0	3,0	25,4	-	18,5	7,0	E	1,30	0,50	2,50	0,20	0,15	0,25

⊗ First choice | Primeira opção | 1ª opción ⊗ Stock item | Produto de stock | Itens de stock ○ Available under request | Disponível sobre consulta Insert order code = (1) Geometry Code + (2) Grade Code
 ⊕ Stock available until sold out | Stock disponível até acabar o stock | Stock disponible hasta acabar el stock Disponible bajo consulta

2 - Correspond to a Specific Holder

BLADES & TOOLHOLDERS CODE KEY

Chave de codificação para lâminas | Llave de codificación de lamas

For Blades

GP	N	C	-	080	25	.A	.0
1	2	3		5	6	7	8

For Toolholders

GP	R	C	-	100	010	25.25	.A	.1
1	2	3		4	5	6	7	8

1 - Product Line

GP - Grooving Plus

2 - Work Side



3 - Tool Type

C - Frontal

4 - Total toolholder length

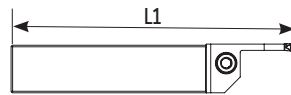

5 - Maximum Depth of Cut

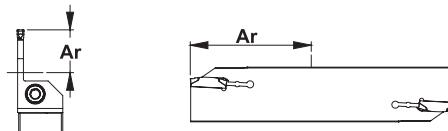

6 - Shaft | Cutting Unit Dimension

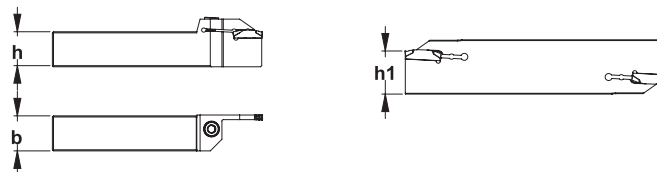

7 - Seat Size

A - 1,60mm | B - 2,30mm | C - 3,30mm | D - 4,30mm | E - 4,00mm | F - 6,60mm

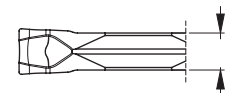

8 - Clamping System

0 - Spring

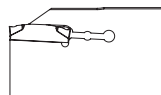

1 - Screw

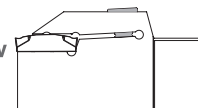

GPNC

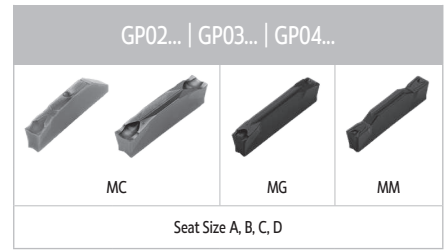

Order separately

Order code Código	Reference Referência Referencia	Dimensions Dimensões Dimensiones (mm)							Insert	Toolholder		Wrench*	Stock
		ar	L1	h	h1	b	W	Seat Size		CPTS	DPTS		
213010000	GPNC-020 25.A.0	20	150	32	25,0	1,5	2	A	GP02...	CPTS 32...	DPTS 32...	LE25-30	☉
213009900	GPNC-055 25.B.0	55	150	32	25,0	2,3	3	B	GP03...	CPTS 32...	DPTS 32...	LE25-30	☉
213009700	GPNC-055 25.C.0	55	150	32	25,0	2,3	4	C	GP04...	CPTS 32...	DPTS 32...	LE25-30	☉

☉ Stock item | Produto de stock | Itens de stock ○ Available under request | Disponível sobre consulta | Disponible bajo consulta

*Note: Wrench must be ordered separately

Note: For inserts with 2 cutting edges, the ar is defined by the insert

CPTS

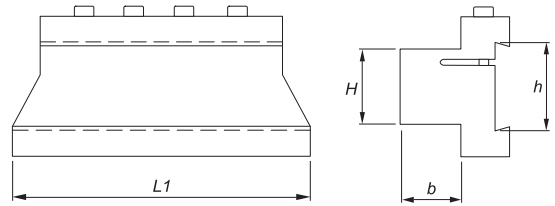

Order code Código	Reference Referência Referencia	Dimensions Dimensões Dimensiones (mm)				Kg	Screw	Wrench	Stock
		h	L1	H	b				
290006200	CPTS 3220	32	100	20	20	0,700	D0603600	SS50	☉
290005000	CPTS 3225	32	110	25	25	0,950	D0603600	SS50	☉
290006300	CPTS 3232	32	120	32	32	1,400	D0603600	SS50	☉

☉ Stock item | Produto de stock | Itens de stock ○ Available under request | Disponível sobre consulta | Disponible bajo consulta

DPTS

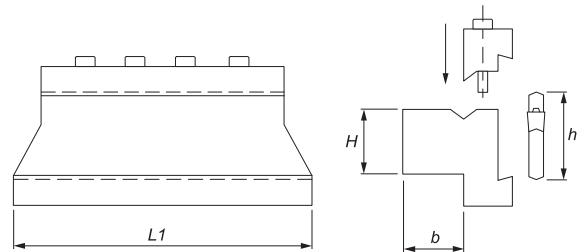

Order code Código	Reference Referência Referencia	Dimensions Dimensões Dimensiones (mm)				Kg	Screw	Wrench	Stock
		h	L1	H	b				
290073600	DPTS 3220	32	100	20	20	0,750	D0603600	SS50	☉
290073700	DPTS 3225	32	110	25	25	1,00	D0603600	SS50	☉
290073800	DPTS 3232	32	120	32	32	1,450	D0603600	SS50	☉

☉ Stock item | Produto de stock | Itens de stock ○ Available under request | Disponível sobre consulta | Disponible bajo consulta

GPLC

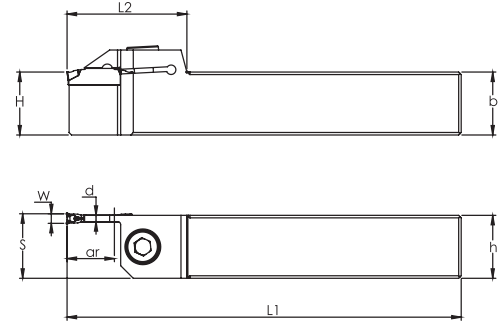
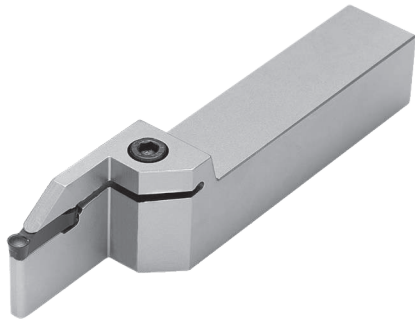

Order code Código	Reference Referência Referencia	Dimensions Dimensões Dimensiones (mm)								Seat Size	Insert	Screw	Wrench	Nm	Stock
		ar	L1	h	b	H	L2	S	W						
183020800	GPLC-100 010 16.16.A.1	10	100	16	16	16	30	16,25	2	A	GP02...	D0602200	SS50	3,0	○
183020900	GPLC-100 015 16.16.A.1	15	100	16	16	16	38	16,25	2		GP02...	D0602200	SS50	4,0	⊗
183021000	GPLC-125 010 20.20.A.1	10	125	20	20	20	32	20,25	2		GP02...	D0602600	SS50	3,0	○
183021100	GPLC-125 015 20.20.A.1	15	125	20	20	20	38	20,25	2		GP02...	D0602600	SS50	4,0	⊗
183021200	GPLC-150 010 25.25.A.1	10	150	25	25	25	34	25,25	2		GP02...	D0603100	SS50	3,0	⊗
183021300	GPLC-150 020 25.25.A.1	20	150	25	25	25	42	25,25	2		GP02...	D0603100	SS50	4,0	⊗
183021400	GPLC-100 010 16.16.B.1	10	100	16	16	16	30	16,5	3	B	GP03...	D0602200	SS50	3,5	○
183021500	GPLC-100 015 16.16.B.1	15	100	16	16	16	38	16,5	3		GP03...	D0602200	SS50	4,5	⊗
183021600	GPLC-125 010 20.20.B.1	10	125	20	20	20	32	20,5	3		GP03...	D0602600	SS50	3,5	○
183021700	GPLC-125 015 20.20.B.1	15	125	20	20	20	38	20,5	3		GP03...	D0602600	SS50	4,5	⊗
183021800	GPLC-150 010 25.25.B.1	10	150	25	25	25	34	25,5	3		GP03...	D0603100	SS50	3,5	⊗
183021900	GPLC-150 020 25.25.B.1	20	150	25	25	25	42	25,5	3		GP03...	D0603100	SS50	5,0	⊗
183022000	GPLC-125 013 20.20.C.1	13	125	20	20	20	32	20,5	4	C	GP04...	D0602600	SS50	5,0	○
183022100	GPLC-125 019 20.20.C.1	19	125	20	20	20	38	20,5	4		GP04...	D0602600	SS50	6,0	⊗
183022200	GPLC-150 013 25.25.C.1	13	150	25	25	25	34	25,5	4		GP04...	D0603100	SS50	5,0	⊗
183022300	GPLC-150 023 25.25.C.1	23	150	25	25	25	42	25,5	4		GP04...	D0603100	SS50	7,0	⊗
183022400	GPLC-125 013 20.20.D.1	13	125	20	20	20	32	20,5	5	D	GP05...	D0602600	SS50	5,0	○
183022500	GPLC-125 019 20.20.D.1	19	125	20	20	20	38	20,5	5		GP05...	D0602600	SS50	6,0	⊗
183022600	GPLC-150 013 25.25.D.1	13	150	25	25	25	34	25,5	5		GP05...	D0603100	SS50	5,0	⊗
183022700	GPLC-150 023 25.25.D.1	23	150	25	25	25	42	25,5	5		GP05...	D0603100	SS50	6,5	⊗
183022800	GPLC-150 015 25.25.E.1	15	150	25	25	25	34	26	6	E	GP06...	D0603100	SS50	5,5	⊗
183022900	GPLC-150 023 25.25.E.1	23	150	25	25	25	42	26	6		GP06...	D0603100	SS50	7,0	⊗

⊗ Stock item | Produto de stock | Itens de stock ○ Available under request | Disponível sobre consulta | Disponible bajo consulta

Note: For inserts with 2 cutting edges, the ar is defined by the insert

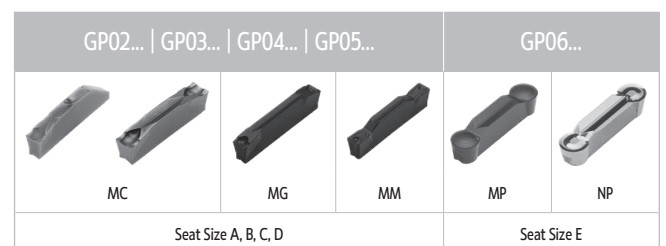

GPRC

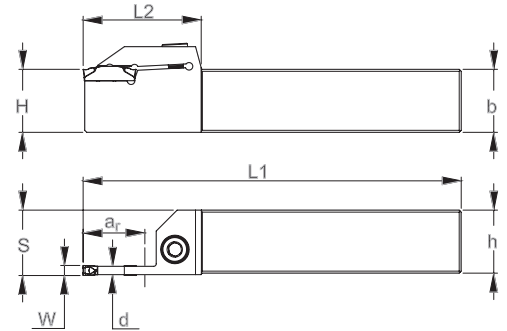
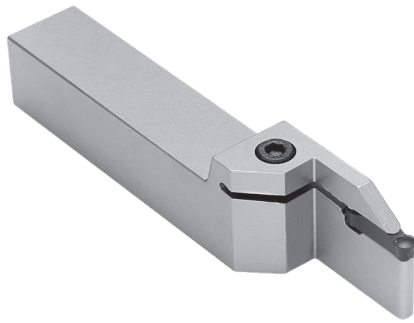

Order code Código	Reference Referência Referencia	Dimensions Dimensões Dimensiones (mm)								Seat Size	Insert	Screw	Wrench	Nm	Stock
		ar	L1	h	b	H	L2	S	W						
183018400	GPRC-100 010 16.16.A.1	10	100	16	16	16	30	16,25	2	A	GP02...	D0602200	SS50	3,0	○
183018500	GPRC-100 015 16.16.A.1	15	100	16	16	16	38	16,25	2		GP02...	D0602200	SS50	4,0	⊗
183018600	GPRC-125 010 20.20.A.1	10	125	20	20	20	32	20,25	2		GP02...	D0602600	SS50	3,0	○
183018700	GPRC-125 015 20.20.A.1	15	125	20	20	20	38	20,25	2		GP02...	D0602600	SS50	4,0	⊗
183018800	GPRC-150 010 25.25.A.1	10	150	25	25	25	34	25,25	2		GP02...	D0603100	SS50	3,0	⊗
183018900	GPRC-150 020 25.25.A.1	20	150	25	25	25	42	25,25	2		GP02...	D0603100	SS50	4,0	⊗
183019000	GPRC-100 010 16.16.B.1	10	100	16	16	16	30	16,5	3	B	GP03...	D0602200	SS50	3,5	○
183019100	GPRC-100 015 16.16.B.1	15	100	16	16	16	38	16,5	3		GP03...	D0602200	SS50	4,5	⊗
183019200	GPRC-125 010 20.20.B.1	10	125	20	20	20	32	20,5	3		GP03...	D0602600	SS50	3,5	○
183019300	GPRC-125 015 20.20.B.1	15	125	20	20	20	38	20,5	3		GP03...	D0602600	SS50	4,5	⊗
183019400	GPRC-150 010 25.25.B.1	10	150	25	25	25	34	25,5	3		GP03...	D0603100	SS50	3,5	⊗
183019500	GPRC-150 020 25.25.B.1	20	150	25	25	25	42	25,5	3		GP03...	D0603100	SS50	5,0	⊗
183018300	GPRC-125 013 20.20.C.1	13	125	20	20	20	32	20,5	4	C	GP04...	D0602600	SS50	5,0	○
183018200	GPRC-125 019 20.20.C.1	19	125	20	20	20	38	20,5	4		GP04...	D0602600	SS50	6,0	⊗
183018100	GPRC-150 013 25.25.C.1	13	150	25	25	25	34	25,5	4		GP04...	D0603100	SS50	5,0	⊗
183018000	GPRC-150 023 25.25.C.1	23	150	25	25	25	42	25,5	4		GP04...	D0603100	SS50	7,0	⊗
183017900	GPRC-125 013 20.20.D.1	13	125	20	20	20	32	20,5	5	D	GP05...	D0602600	SS50	5,0	○
183017800	GPRC-125 019 20.20.D.1	19	125	20	20	20	38	20,5	5		GP05...	D0602600	SS50	6,0	⊗
183017700	GPRC-150 013 25.25.D.1	13	150	25	25	25	34	25,5	5		GP05...	D0603100	SS50	5,0	⊗
183017600	GPRC-150 023 25.25.D.1	23	150	25	25	25	42	25,5	5		GP05...	D0603100	SS50	6,5	⊗
183017500	GPRC-150 015 25.25.E.1	15	150	25	25	25	34	26	6	E	GP06...	D0603100	SS50	5,5	⊗
183020500	GPRC-150 023 25.25.E.1	23	150	25	25	25	42	26	6		GP06...	D0603100	SS50	7,0	⊗

⊗ Stock item | Produto de stock | Itens de stock ○ Available under request | Disponível sobre consulta | Disponible bajo consulta

Note: For inserts with 2 cutting edges, the ar is defined by the insert

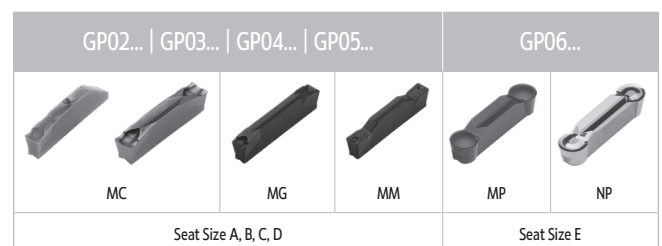

Feed recommendations and geometry descriptions

Grooving & Parting Off

GP...02-MC

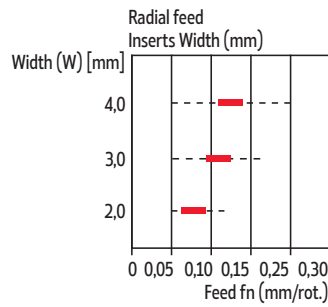
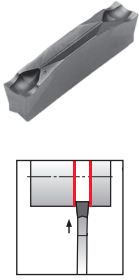

Medium Parting Off

Recommended for parting off, thin walled tubes and small diameter components in all materials.

The positive geometry eliminates the risk of built-up edge.

Low cutting forces resulting in reduced vibration.

GP...02-MG

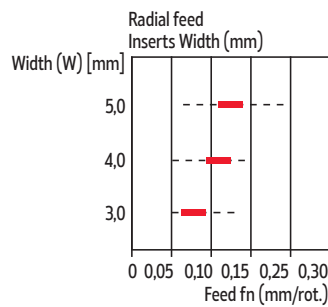
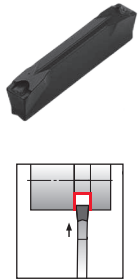

Medium Grooving

Outstanding chip control.

Reduces chip width giving good surfaces.

For all materials.

GP...02-MM

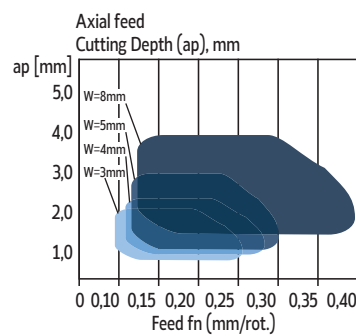
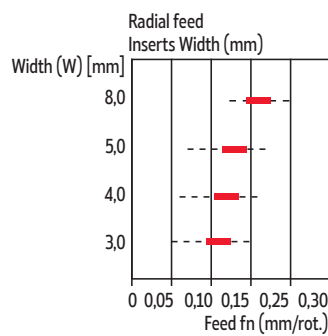
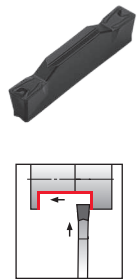

Medium Multi Function (Grooving & Turning)

For grooving and turning in all materials.

Good chip control.

D

GROOVING & PARTING OFF

Grooving Plus



Grooving & Parting Off

SAL - Swiss Automatic Lathes

Light Grooving

Forming Grooving

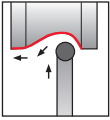
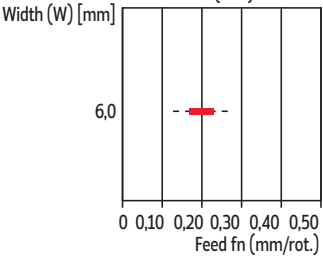
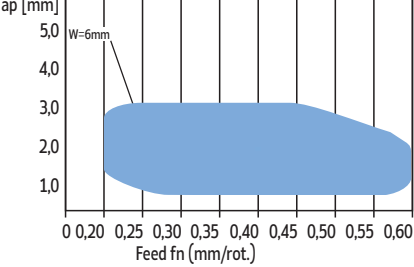
Technical Data

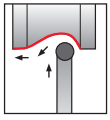
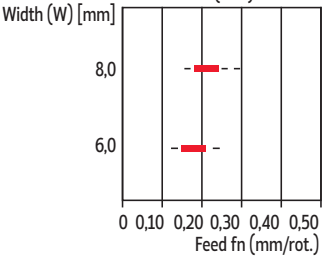
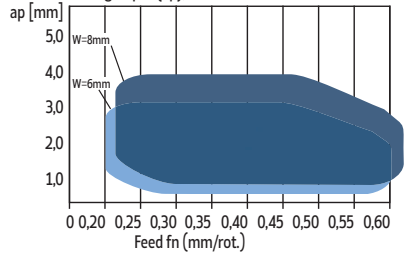
Feed recommendations and geometry descriptions		Grooving & Parting Off	
<p>GP...02-MP</p>  	<p>Radial feed Inserts Width (mm)</p> 	<p>Axial feed Cutting Depth (ap), mm</p> 	<p>Medium Profiling</p> <p>For profiling all materials.</p> <p>Outstanding chip control even at low feeds and small depths of cut.</p> <p>Good surface finish.</p>
<p>GP...02-NP</p>  	<p>Radial feed Inserts Width (mm)</p> 	<p>Axial feed Cutting Depth (ap), mm</p> 	<p>Medium Aluminium profiling</p> <p>First choice for profiling in non-ferrous materials.</p> <p>Good chip flow provides a better surface finishing.</p> <p>Sharp cutting edge.</p>

GCMX & SANCAR INSERTS CODE KEY

Chave de codificação para pastilhas | Llave de codificación para plaquitas

For GCMX Inserts



For SANCAR Inserts

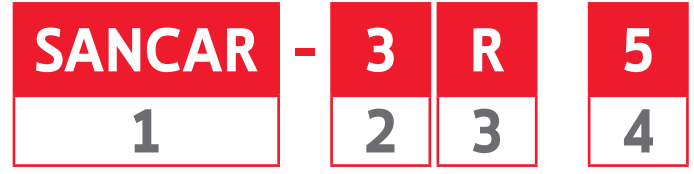

1 - Product Line



GCMX



SANCAR

2 - Cutting Width

2mm | 2,4mm | 3mm | 4mm | 4,8mm | 5mm | 6mm

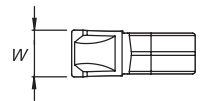

3 - Inserts Type

N - Neutral | R - Right | L - Left

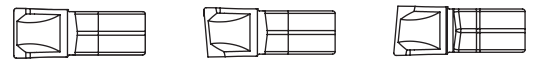

4 - Relief Angle

4 - 4° | 5 - 5° | 8 - 8° | 15 - 15°

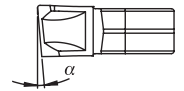

INSERTS OVERVIEW | Visão geral | Visión general

Operation		Parting Off	General Grooving	Turning	Profiling
Insert Type + Chipbreaker		GCMX-...			
		SANCAR-...			

First choice | Primeira opção | Primera opción

Alternative | Alternativa

GCMX-N

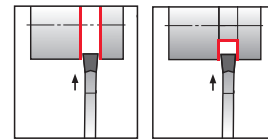
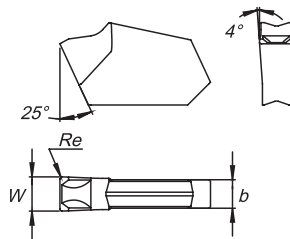

(1) Geometry code	ISO Reference	ANSI Reference	P		M		K		Dimensions (mm)				Cutting Conditions		
			(2) Grade code		CVD-MT	CVD-MT	CVD-MT	L7							N2
			PH5115	PH5135	PH5135	PH5320	PH5135	W	b	Re	α	fn (mm/r)	Min	Max	
1130165	GCMX-2N	GTN-2N	⊗	⊗	⊗	⊗	⊗	⊗	2,2	1,8	0,16	-	0,08	0,05	0,16
1130228	GCMX-2.4N	GTN-2.4N	○	○	○	○	○	○	2,4	2,0	0,16	-	0,10	0,06	0,18
1130169	GCMX-3N	GTN-3N	⊗	⊗	⊗	⊗	⊗	⊗	3,1	2,6	0,20	-	0,15	0,10	0,25
1130174	GCMX-4N	GTN-4N	⊗	⊗	⊗	⊗	⊗	⊗	4,1	3,5	0,25	-	0,18	0,10	0,30
1130229	GCMX-4.8N	GTN-4.8N	○	○	○	○	○	○	4,8	4,2	0,28	-	0,20	0,12	0,35
1130175	GCMX-5N	GTN-5N	⊗	⊗	⊗	⊗	⊗	⊗	5,1	4,5	0,28	-	0,20	0,12	0,35
1130176	GCMX-6N	GTN-6N	⊗	⊗	⊗	⊗	⊗	⊗	6,4	5,5	0,35	-	0,25	0,15	0,40
1130449	GCMX-8N	GTN-8N	○	○	○	○	○	○	8,0	7,1	0,40	-	0,28	0,17	0,45

⊗ First choice | Primeira opção | 1ª opção

⊗ Stock item | Produto de stock | Itens de stock

○ Available under request | Disponível sobre consulta
Disponibile bajo consulta

Insert order code = (1) Geometry Code + (2) Grade Code



INSERTS

GCMX-R

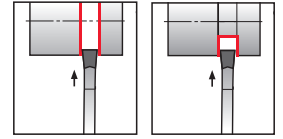
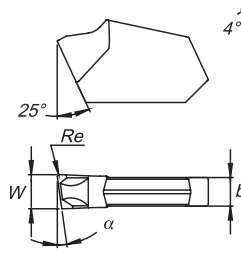

(1) Geometry code	ISO Reference	ANSI Reference	P		M		K		Dimensions (mm)				Cutting Conditions		
			CVD-MT		CVD-MT		CVD-MT								
			L7	N2	N2	L6	N2	W	b	Re	α	fn (mm/r)	Min	Max	
1130166	GCMX-2R 4	GTN-2R 4	○	○	○	○	○	○	2,2	1,8	0,16	4	0,07	0,04	0,13
1130167	GCMX-2R 8	GTN-2R 8	○	○	○	○	○	○	2,2	1,8	0,16	8	0,06	0,04	0,11
1130255	GCMX-2R 15	GTN-2R 15	○	○	○	○	○	○	2,2	1,8	0,16	15	0,06	0,04	0,09
1130257	GCMX-2.4R 4	GTN-2.4R 4	○	○	○	○	○	○	2,4	2,0	0,16	4	0,08	0,04	0,14
1130233	GCMX-2.4R 8	GTN-2.4R 8	○	○	○	○	○	○	2,4	2,0	0,16	8	0,07	0,04	0,12
1130258	GCMX-2.4R 15	GTN-2.4R 15	○	○	○	○	○	○	2,4	2,0	0,16	15	0,06	0,04	0,10
1130170	GCMX-3R 4	GTN-3R 4	○	○	○	○	○	○	3,1	2,6	0,20	4	0,08	0,05	0,15
1130171	GCMX-3R 8	GTN-3R 8	○	○	○	○	○	○	3,1	2,6	0,20	8	0,07	0,05	0,12
1130253	GCMX-3R 15	GTN-3R 15	○	○	○	○	○	○	3,1	2,6	0,20	15	0,06	0,05	0,10
1130261	GCMX-4R 4	GTN-4R 4	○	○	○	○	○	○	4,1	3,5	0,25	4	0,12	0,08	0,20
1130222	GCMX-4R 8	GTN-4R 8	○	○	○	○	○	○	4,1	3,5	0,25	8	0,10	0,08	0,12
1130262	GCMX-4R 15	GTN-4R 15	○	○	○	○	○	○	4,1	3,5	0,25	15	0,10	0,08	0,12
1130264	GCMX-4.8R 4	GTN-4.8R 4	○	○	○	○	○	○	4,8	4,2	0,28	4	0,18	0,10	0,25
1130230	GCMX-4.8R 8	GTN-4.8R 8	○	○	○	○	○	○	4,8	4,2	0,28	8	0,13	0,10	0,18
1130265	GCMX-4.8R 15	GTN-4.8R 15	○	○	○	○	○	○	4,8	4,2	0,28	15	0,12	0,09	0,15
1130268	GCMX-5R 4	GTN-5R 4	○	○	○	○	○	○	5,1	4,5	0,28	4	0,18	0,10	0,25
1130224	GCMX-5R 8	GTN-5R 8	○	○	○	○	○	○	5,1	4,5	0,28	8	0,13	0,10	0,18
1130269	GCMX-5R 15	GTN-5R 15	○	○	○	○	○	○	5,1	4,5	0,28	15	0,12	0,09	0,15
1130272	GCMX-6R 4	GTN-6R 4	○	○	○	○	○	○	6,4	5,5	0,35	4	0,20	0,10	0,30
1130227	GCMX-6R 8	GTN-6R 8	○	○	○	○	○	○	6,4	5,5	0,35	8	0,17	0,12	0,20
1130276	GCMX-6R 15	GTN-6R 15	○	○	○	○	○	○	6,4	5,5	0,35	15	0,14	0,10	0,18

🟢 First choice | Primeira opção | 1ª opción

📦 Stock item | Produto de stock | Itens de stock

○ Available under request | Disponível sobre consulta
Disponível bajo consulta

Insert order code = (1) Geometry Code + (2) Grade Code

GCMX=L

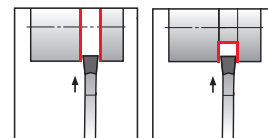
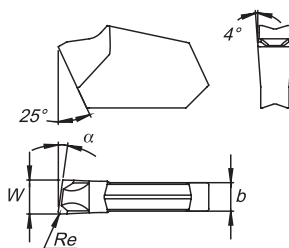

(1) Geometry code	ISO Reference	ANSI Reference	P		M		K		Dimensions (mm)				Cutting Conditions		
			(2) Grade code		CVD-MT	CVD-MT	CVD-MT	L7							N2
			PH5115	PH5135	PH5135	PH5320	PH5135	W	b	Re	α	fn (mm/r)	Min	Max	
1130164	GCMX-2L 4	GTN-2L 4	○	○	○	○	○	○	2,2	1,8	0,16	4	0,07	0,04	0,13
1130220	GCMX-2L 8	GTN-2L 8	○	○	○	○	○	○	2,2	1,8	0,16	8	0,06	0,04	0,11
1130256	GCMX-2L 15	GTN-2L 15	○	○	○	○	○	○	2,2	1,8	0,16	15	0,06	0,04	0,09
1130259	GCMX-2.4L 4	GTN-2.4L 4	○	○	○	○	○	○	2,4	2,0	0,16	4	0,08	0,04	0,14
1130232	GCMX-2.4L 8	GTN-2.4L 8	○	○	○	○	○	○	2,4	2,0	0,16	8	0,07	0,04	0,12
1130260	GCMX-2.4L 15	GTN-2.4L 15	○	○	○	○	○	○	2,4	2,0	0,16	15	0,06	0,04	0,10
1130221	GCMX-3L 4	GTN-3L 4	○	○	○	○	○	○	3,1	2,6	0,20	4	0,08	0,05	0,15
1130168	GCMX-3L 8	GTN-3L 8	○	○	○	○	○	○	3,1	2,6	0,20	8	0,07	0,05	0,12
1130254	GCMX-3L 15	GTN-3L 15	○	○	○	○	○	○	3,1	2,6	0,20	15	0,06	0,05	0,10
1130173	GCMX-4L 4	GTN-4L 4	○	○	○	○	○	○	4,1	3,5	0,25	4	0,12	0,08	0,20
1130223	GCMX-4L 8	GTN-4L 8	○	○	○	○	○	○	4,1	3,5	0,25	8	0,10	0,08	0,12
1130263	GCMX-4L 15	GTN-4L 15	○	○	○	○	○	○	4,1	3,5	0,25	15	0,10	0,08	0,12
1130266	GCMX-4.8L 4	GTN-4.8L 4	○	○	○	○	○	○	4,8	4,2	0,28	4	0,18	0,10	0,25
1130231	GCMX-4.8L 8	GTN-4.8L 8	○	○	○	○	○	○	4,8	4,2	0,28	8	0,13	0,10	0,18
1130267	GCMX-4.8L 15	GTN-4.8L 15	○	○	○	○	○	○	4,8	4,2	0,28	15	0,12	0,09	0,15
1130270	GCMX-5L 4	GTN-5L 4	○	○	○	○	○	○	5,1	4,5	0,28	4	0,18	0,10	0,25
1130225	GCMX-5L 8	GTN-5L 8	○	○	○	○	○	○	5,1	4,5	0,28	8	0,13	0,10	0,18
1130271	GCMX-5L 15	GTN-5L 15	○	○	○	○	○	○	5,1	4,5	0,28	15	0,12	0,09	0,15
1130274	GCMX-6L 4	GTN-6L 4	○	○	○	○	○	○	6,4	5,5	0,35	4	0,20	0,10	0,30
1130226	GCMX-6L 8	GTN-6L 8	○	○	○	○	○	○	6,4	5,5	0,35	8	0,17	0,12	0,20
1130275	GCMX-6L 15	GTN-6L 15	○	○	○	○	○	○	6,4	5,5	0,35	15	0,14	0,10	0,18

🏆 First choice | Primeira opção | 1ª opción

📦 Stock item | Produto de stock | Itens de stock

○ Available under request | Disponível sobre consulta
Disponibile bajo consulta

Insert order code = (1) Geometry Code + (2) Grade Code

SANCAR

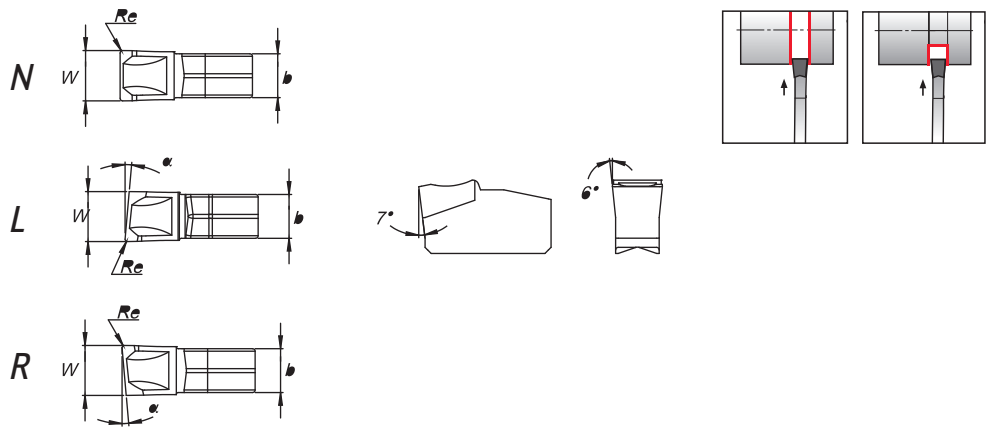

			P		M	K		Dimensions (mm)				Cutting Conditions		
			CVD-MT		CVD-MT	CVD-MT								
	⁽²⁾ Grade code		L7	N2	N2	L6	N2	W	b	Re	α	fn (mm/r)	Min	Max
⁽¹⁾ Geometry code	ISO Reference	ANSI Reference	PH5115	PH5135	PH5135	PH5320	PH5135							
1130186	SANCAR-3N	SANCAR-3N	⊗	⊗	⊗	⊗	⊗	3,0	2,5	0,25	-	0,13	0,05	0,25
1130187	SANCAR-4N	SANCAR-4N	⊗	⊗	⊗	⊗	⊗	4,0	3,3	0,25	-	0,18	0,10	0,30
1130189	SANCAR-5N	SANCAR-5N	⊗	⊗	⊗	⊗	⊗	5,0	4,3	0,25	-	0,22	0,10	0,35
1130185	SANCAR-3L 5	SANCAR-3L 5	○	○	○	○	○	3,0	2,5	0,25	5	0,10	0,05	0,15
1130390	SANCAR-4L 5	SANCAR-4L 5	○	○	○	○	○	4,0	3,3	0,25	5	0,12	0,08	0,20
1130389	SANCAR-5L 5	SANCAL-5L 5	○	○	○	○	○	5,0	4,3	0,25	5	0,15	0,08	0,25
1130288	SANCAR-3R 5	SANCAR-3R 5	○	○	○	○	○	3,0	2,5	0,25	5	0,10	0,05	0,15
1130188	SANCAR-4R 5	SANCAR-4R 5	○	○	○	○	○	4,0	3,3	0,25	5	0,12	0,08	0,20
1130388	SANCAR-5R 5	SANCAR-5R 5	○	○	○	○	○	5,0	4,3	0,25	5	0,15	0,08	0,25

⊗ First choice | Primeira opção | 1ª opción

⊗ Stock item | Produto de stock | Itens de stock

○ Available under request | Disponível sobre consulta
Disponível bajo consulta

Insert order code = (1) Geometry Code + (2) Grade Code



1 - Product Line

BL - Blade

2 - Blade Type

ST - Standard
Blade

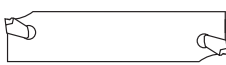

S - SANCAR
Blade



3 - Cutting Width

2mm | 3mm | 4mm | 5mm | 6mm



4 - Maximum Depth of Cut

19 - 19mm | 26 - 26mm | 32 - 32mm

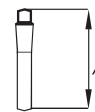

D

GROOVING & PARTING OFF

Grooving Plus

Grooving & Parting Off

SAL - Swiss Automatic Lathes

Light Grooving

Forming Grooving

Technical Data

BLST (GCMX)

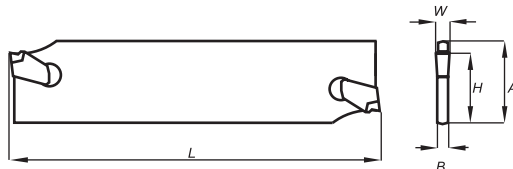

GCMX...



Hand Type
N, R, L

Order code Código	Reference Referência Referencia	Dimensions Dimensões Dimensiones (mm)					Inserts	Toolholder		Wrench	Stock
		A	W	H	B	L		CPTS	DPTS		
213008000	BLST 2-19	19	2	16	1,6	85	GCMX-2...	CPTS 19...	DPTS 19...	LE05	☉
213008100	BLST 2-26	26	2	21,4	1,6	110	GCMX-2...	CPTS 26...	DPTS 26...	LE05	☉
213008200	BLST 3-26	26	3	21,4	2,4	110	GCMX-3...	CPTS 26...	DPTS 26...	LE05	☉
213008300	BLST 4-26	26	4	21,4	3,2	110	GCMX-4...	CPTS 26...	DPTS 26...	LE05	☉
213008400	BLST 5-26	26	5	21,4	4	110	GCMX-5...	CPTS 26...	DPTS 26...	LE05	☉
213008500	BLST 6-26	26	6	21,4	5,2	110	GCMX-6...	CPTS 26...	DPTS 26...	LE05	☉
213008600	BLST 2-32	32	2	25	1,6	150	GCMX-2...	CPTS 32...	DPTS 32...	LE05	☉
213008700	BLST 3-32	32	3	25	2,4	150	GCMX-3...	CPTS 32...	DPTS 32...	LE05	☉
213008800	BLST 4-32	32	4	25	3,2	150	GCMX-4...	CPTS 32...	DPTS 32...	LE05	☉
213008900	BLST 5-32	32	5	25	4	150	GCMX-5...	CPTS 32...	DPTS 32...	LE05	☉
213009000	BLST 6-32	32	6	25	5,2	150	GCMX-6...	CPTS 32...	DPTS 32...	LE05	☉

☉ Stock item | Produto de stock | Itens de stock ○ Available under request | Disponível sobre consulta | Disponible bajo consulta

BLS (SANCAR)

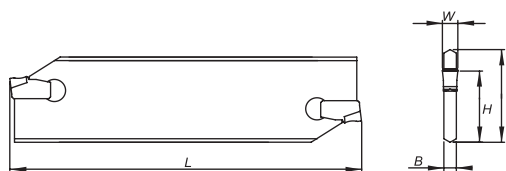

SANCAR...



Hand Type
N, R, L

Order code Código	Reference Referência Referencia	Dimensions Dimensões Dimensiones (mm)					Inserts	Toolholder		Wrench	Stock
		A	W	H	B	L		CPTS	DPTS		
213004600	BLS 3-32	32	3	25	2,4	150	SANCAR 3...	CPTS 32...	DPTS 32...	LE05	☉
213004700	BLS 4-32	32	4	25	3,2	150	SANCAR 4...	CPTS 32...	DPTS 32...	LE05	☉
213005500	BLS 5-32	32	5	25	4	150	SANCAR 5...	CPTS 32...	DPTS 32...	LE05	☉

☉ Stock item | Produto de stock | Itens de stock ○ Available under request | Disponível sobre consulta | Disponible bajo consulta

CUTTING PARAMETERS || Parâmetros de corte | Parámetros de corte

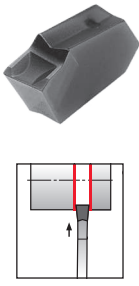
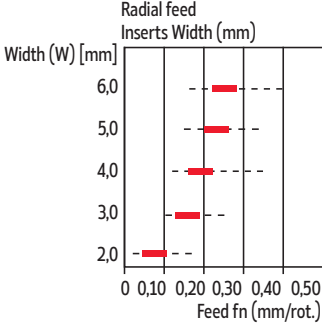
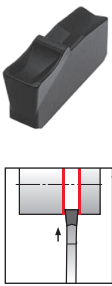
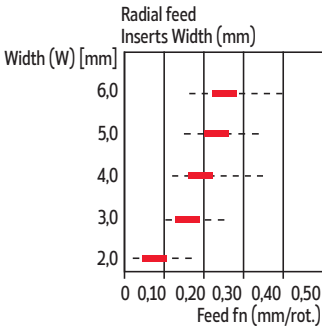
Feed recommendations and geometry descriptions		Grooving & Parting Off												
<p>GCMX-...</p> 	<p>Radial feed Inserts Width (mm)</p>  <table border="1"> <caption>Radial feed recommendations for GCMX-...</caption> <thead> <tr> <th>Inserts Width (mm)</th> <th>Feed fn (mm/rot.)</th> </tr> </thead> <tbody> <tr> <td>2.0</td> <td>0.10</td> </tr> <tr> <td>3.0</td> <td>0.20</td> </tr> <tr> <td>4.0</td> <td>0.25</td> </tr> <tr> <td>5.0</td> <td>0.30</td> </tr> <tr> <td>6.0</td> <td>0.35</td> </tr> </tbody> </table> <p>Width (W) [mm]</p> <p>Feed fn (mm/rot.)</p>	Inserts Width (mm)	Feed fn (mm/rot.)	2.0	0.10	3.0	0.20	4.0	0.25	5.0	0.30	6.0	0.35	<p>Medium Parting Off</p> <p>Most efficient on stainless steel and most types of steel at moderate feed rates. Superior straightness of cut</p>
Inserts Width (mm)	Feed fn (mm/rot.)													
2.0	0.10													
3.0	0.20													
4.0	0.25													
5.0	0.30													
6.0	0.35													
<p>SANCAR-...</p> 	<p>Radial feed Inserts Width (mm)</p>  <table border="1"> <caption>Radial feed recommendations for SANCAR-...</caption> <thead> <tr> <th>Inserts Width (mm)</th> <th>Feed fn (mm/rot.)</th> </tr> </thead> <tbody> <tr> <td>2.0</td> <td>0.10</td> </tr> <tr> <td>3.0</td> <td>0.20</td> </tr> <tr> <td>4.0</td> <td>0.25</td> </tr> <tr> <td>5.0</td> <td>0.30</td> </tr> <tr> <td>6.0</td> <td>0.35</td> </tr> </tbody> </table> <p>Width (W) [mm]</p> <p>Feed fn (mm/rot.)</p>	Inserts Width (mm)	Feed fn (mm/rot.)	2.0	0.10	3.0	0.20	4.0	0.25	5.0	0.30	6.0	0.35	<p>Medium Parting Off</p> <p>Optimizer to minimize pips and burrs on components. Recommended for steel, stainless steel and cast iron.</p>
Inserts Width (mm)	Feed fn (mm/rot.)													
2.0	0.10													
3.0	0.20													
4.0	0.25													
5.0	0.30													
6.0	0.35													

 Recommended starting value.
 For cutting speed recommendations, see page D-693

CPTS

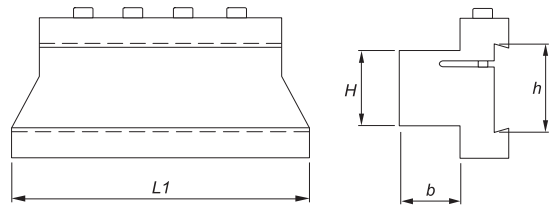

Order code Código	Reference Referência Referencia	Dimensions Dimensões Dimensiones (mm)				Kg	Screw	Wrench	Stock
		h	L1	H	b				
290009300	CPTS 1916	19	76	16	16	0,300	D0503000	SS40	☉
290008200	CPTS 2616	26	76	16	16	0,450	D0603600	SS50	☉
290006000	CPTS 2620	26	87	20	20	0,500	D0603600	SS50	☉
290006100	CPTS 2625	26	87	25	25	0,650	D0603600	SS50	☉
290006200	CPTS 3220	32	100	20	20	0,700	D0603600	SS50	☉
290005000	CPTS 3225	32	110	25	25	0,950	D0603600	SS50	☉
290006300	CPTS 3232	32	120	32	32	1,400	D0603600	SS50	☉

☉ Stock item | Produto de stock | Itens de stock

○ Available under request | Disponível sobre consulta | Disponible bajo consulta

DPTS

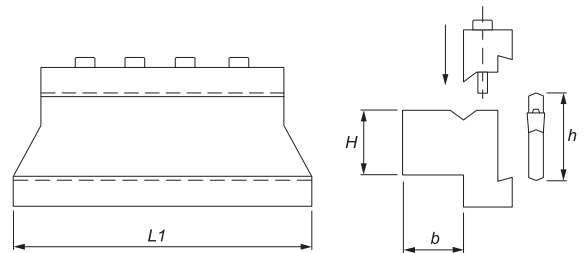

Order code Código	Reference Referência Referencia	Dimensions Dimensões Dimensiones (mm)				Kg	Screw	Wrench	Stock
		h	L1	H	b				
290045400	DPTS 1916	19	76	16	16	0,250	D0503000	SS40	☉
290045500	DPTS 2620	26	87	20	20	0,550	D0603600	SS50	☉
290046600	DPTS 2625	26	87	25	25	0,700	D0603600	SS50	☉
290073600	DPTS 3220	32	100	20	20	0,750	D0603600	SS50	☉
290073700	DPTS 3225	32	110	25	25	1,00	D0603600	SS50	☉
290073800	DPTS 3232	32	120	32	32	1,450	D0603600	SS50	☉

☉ Stock item | Produto de stock | Itens de stock

○ Available under request | Disponível sobre consulta | Disponible bajo consulta

TRIGON INSERTS CODE KEY

Chave de codificação para pastilhas | Llave de codificación para plaquitas

For Trigon 60° Inserts



1 - Inscribed Circle

16 - 9,525mm



2 - Insert Type

ER - External Right | IR - Internal Right

3 - Cutting Edge Type

W - Rectangular



R - Rounded



4 - Cutting Edge Length

0,50 - 0,5mm | 2,25 - 2,25mm

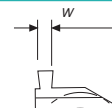

D

GROOVING & PARTING OFF

Grooving Plus

Grooving & Parting Off

SAL - Swiss Automatic Lathes

Light Grooving

Forming Grooving

Technical Data

TRIGON INSERTS

FLAT GROOVING

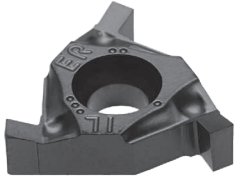

External

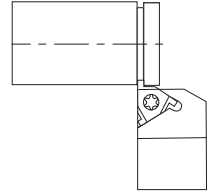
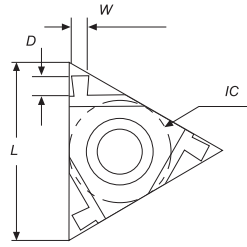

Inserts ER = IL

Order code Código	Reference Referência Referencia	Anvil	Dimensions Dimensões Dimensiones (mm)				Stock - Grade Code (2)	
			IC	L	W	D	(68) PH6920	(D0) PH8920
1883721	11 ER W 0.50	-	6,35	11,00	0,50	1,40	○	○
1883722	11 ER W 0.60	-	6,35	11,00	0,60	1,40	○	○
1883723	11 ER W 0.70	-	6,35	11,00	0,70	1,40	○	○
1883724	11 ER W 0.80	-	6,35	11,00	0,80	1,40	○	○
1883725	11 ER W 1.00	-	6,35	11,00	1,00	1,30	○	○
1883726	16 ER W 0.50	EA 16	9,525	16,00	0,50	1,40	○	○
1881125	16 ER W 1.00	EA 16	9,525	16,00	1,00	1,40	⊗	○
1883707	16 ER W 1.20	EA 16	9,525	16,00	1,20	1,60	⊗	○
1883720	16 ER W 1.40	EA 16	9,525	16,00	1,40	1,80	⊗	○
1881129	16 ER W 1.70	EA 16	9,525	16,00	1,70	2,00	⊗	⊗
1883711	16 ER W 1.95	EA 16	9,525	16,00	1,95	2,00	⊗	⊗
1883714	16 ER W 2.25	EA 16	9,525	16,00	2,25	2,25	⊗	⊗

⊗ Stock item | Produto de stock | Itens de stock ○ Available under request | Disponível sobre consulta | Disponible bajo consulta

Note: Select the toolholder "SXAN"

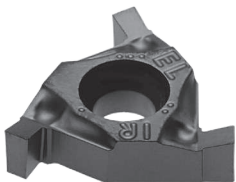

Internal

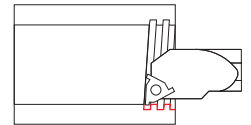
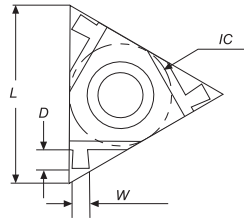

Inserts IR = EL

Order code Código	Reference Referência Referencia	Anvil	Dimensions Dimensões Dimensiones (mm)				Stock - Grade Code (2)	
			IC	L	W	D	(68) PH6920	(D0) PH8920
1881142	11 IR W 0.50	-	6,35	11,00	0,50	1,40	⊗	○
1883727	11 IR W 0.60	-	6,35	11,00	0,60	1,40	○	○
1883728	11 IR W 0.70	-	6,35	11,00	0,70	1,40	○	○
1883729	11 IR W 0.80	-	6,35	11,00	0,80	1,40	○	○
1881144	11 IR W 1.00	-	6,35	11,00	1,00	1,30	⊗	○
1883730	16 IR W 0.50	EA 16	9,525	16,00	0,50	1,40	○	○
1881134	16 IR W 1.00	EA 16	9,525	16,00	1,00	1,40	⊗	○
1883731	16 IR W 1.20	EA 16	9,525	16,00	1,20	1,60	⊗	○
1883712	16 IR W 1.40	EA 16	9,525	16,00	1,40	1,80	⊗	○
1881138	16 IR W 1.70	EA 16	9,525	16,00	1,70	2,00	⊗	○
1883710	16 IR W 1.95	EA 16	9,525	16,00	1,95	2,00	⊗	○
1883713	16 IR W 2.25	EA 16	9,525	16,00	2,25	2,25	⊗	○

⊗ Stock item | Produto de stock | Itens de stock ○ Available under request | Disponível sobre consulta | Disponible bajo consulta

Note: Select the toolholder "SXFN"

FULL RADIUS GROOVING

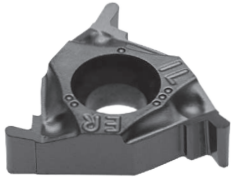

External

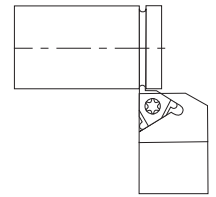
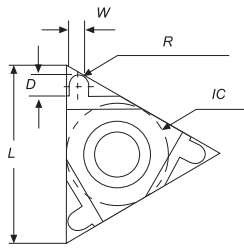

Inserts ER = IL

Order code Código	Reference Referência Referencia	Anvil	Dimensions Dimensões Dimensiones (mm)					Stock - Grade Code (2)	
			IC	L	W	R	D	(68) PH6920	(D0) PH8920
1881149	16 ER R 0.50	EA 16	9,525	16	1,00	0,50	1,40	☉	○
1883732	16 ER R 0.60	EA 16	9,525	16	1,20	0,60	1,60	○	○
1883733	16 ER R 0.90	EA 16	9,525	16	1,80	0,90	2,00	○	○
1881151	16 ER R 1.00	EA 16	9,525	16	2,00	1,00	2,00	○	○
1883734	16 ER R 1.10	EA 16	9,525	16	2,20	1,10	2,15	○	○
1883735	16 ER R 1.20	EA 16	9,525	16	2,40	1,20	2,15	○	○

☉ Stock item | Produto de stock | Itens de stock ○ Available under request | Disponível sobre consulta | Disponible bajo consulta

Note: Select the toolholder "SXAN"



Internal

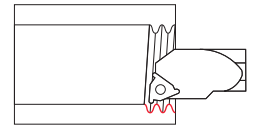
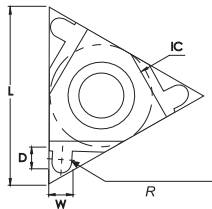

Inserts IR = EL

Order code Código	Reference Referência Referencia	Anvil	Dimensions Dimensões Dimensiones (mm)					Stock - Grade Code (2)	
			IC	L	W	R	D	(68) PH6920	(D0) PH8920
1881145	16 IR R 0.50	EA 16	9,525	16	1,00	0,50	1,40	○	○
1883736	16 IR R 0.60	EA 16	9,525	16	2,00	1,00	1,40	○	○
1883737	16 IR R 0.90	EA 16	9,525	16	2,40	1,20	1,60	○	○
1881147	16 IR R 1.00	EA 16	9,525	16	2,80	1,40	1,80	○	○
1883738	16 IR R 1.10	EA 16	9,525	16	3,40	1,70	2,00	○	○
1883739	16 IR R 1.20	EA 16	9,525	16	3,90	1,95	2,00	○	○

☉ Stock item | Produto de stock | Itens de stock ○ Available under request | Disponível sobre consulta | Disponible bajo consulta

Note: Select the toolholder "SXFN"

EXTERNAL TOOLHOLDERS CODE KEY

Chave de codificação para suporte externos | Llave de codificación para herramienta exterior

S	X	A	N
1	2	3	4

R
5

25
6

25
7

M
8

16
9

1 - Inserts Clamping System

C	D	M	P	S

2 - Insert Shape

C	D	E	K
R	S	T	V
X	W		

4 - Inserts Clearance Angle

B	C	N	P

5 - Tool Hand

R	L	N

3 - Toolholder Leading Angle

A	B	C
D	E	F
G	H	J
K	L	M
N	Q	R
S	T	V
X	Z	

6 - Height of Shank (mm)

H1	H

7 - Width of Shank (mm)

B

8 - Length of Holder (mm)

	D	60	P	170
	E	70	R	200
	F	80	S	250
	H	100	T	300
	K	125	U	350
	L	140	V	400
	M	150	X	Special

9 - Length of Inserts Cutting Edge (mm)

C,D,E,V	K	R	S
T	W	X	Z

SXAN



External Left

Order Code Código	Reference Referência Referencia	Insert Geometry	Dimensions Dimensões Dimensiones (mm)				Anvil	Anvil Screw	Insert Screw	Torx Key	Stock
			H=h1	b	S	L					
212244300	SXAN L 0808 H11	11 EL	8	8	11	100	-	-	P0260700	XT08	○
212244400	SXAN L 1010 H11	11 EL	10	10	11	100	-	-	P0260700	XT08	⊗
212384500	SXAN L 1212 K11	11 EL	12	12	12	125	-	-	P0260700	XT08	○
212384600	SXAN L 1212 F16	16 EL	12	12	16	80	IA16	P5000790	P5401390	XT10	○
212123400	SXAN L 1616 H16	16 EL	16	16	16	100	IA16	P5000790	P5401390	XT10	○
212123500	SXAN L 2020 K16	16 EL	20	20	20	125	IA16	P5000790	P5401390	XT10	⊗
212123800	SXAN L 2525 M16	16 EL	25	25	25	150	IA16	P5000790	P5401390	XT10	⊗
212124400	SXAN L 3232 P16	16 EL	32	32	32	170	IA16	P5000790	P5401390	XT10	○

⊗ Stock item | Produto de stock | Itens de stock

○ Available under request | Disponível sobre consulta | Disponible bajo consulta

External Right

Order Code Código	Reference Referência Referencia	Insert Geometry	Dimensions Dimensões Dimensiones (mm)				Anvil	Anvil Screw	Insert Screw	Torx Key	Stock
			H=h1	b	S	L					
212244700	SXAN R 0808 H11	11 ER	8	8	10	100	-	-	P0260700	XT08	○
212244800	SXAN R 1010 H11	11 ER	10	10	10	100	-	-	P0260700	XT08	⊗
212384900	SXAN R 1212 K11	11 ER	12	12	12	125	-	-	P0260700	XT08	○
212383800	SXAN R 1212 F16	16 ER	12	12	16	80	EA16	P5000790	P5401390	XT10	⊗
212053800	SXAN R 1616 H16	16 ER	16	16	16	100	EA16	P5000790	P5401390	XT10	⊗
212053100	SXAN R 2020 K16	16 ER	20	20	20	125	EA16	P5000790	P5401390	XT10	⊗
212053200	SXAN R 2525 M16	16 ER	25	25	25	150	EA16	P5000790	P5401390	XT10	⊗
212124300	SXAN R 3232 P16	16 ER	32	32	32	170	EA16	P5000790	P5401390	XT10	⊗

⊗ Stock item | Produto de stock | Itens de stock

○ Available under request | Disponível sobre consulta | Disponible bajo consulta

INTERNAL TOOLHOLDERS CODE KEY

Chave de codificação para suporte internos | Llave de codificación para herramienta interior

S	32	S	S	X	F	N	R	16
1	2	3	4	5	6	7	8	9

1 - Bar Type

S	Steel shank
----------	-------------

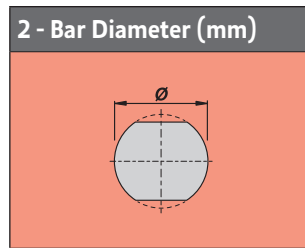

3 - Bar Length (mm)

H	100	T	300
J	110	U	350
K	125	V	400
L	140	W	450
M	150	Y	500
Q	180	X	Special
R	200		
S	250		

4 - Inserts Clamping System

C	M	P	S

5 - Insert Shape

C	D	E	K
S	T	V	W
X			

6 - Bar Leading Angle

F	K	L
Q	U	U-BT
G		

7 - Inserts Clearance Angle

B	C	N	P

8 - Bar Hand

L	R	N

9 - Length of Inserts Cutting Edge (mm)

C,D,E,V	K	S	T	W

D
GROOVING & PARTING OFF
Grooving Plus
Grooving & Parting Off
SAL - Swiss Automatic Lathes
Light Grooving
Forming Grooving
Technical Data

SXFN

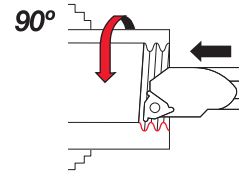
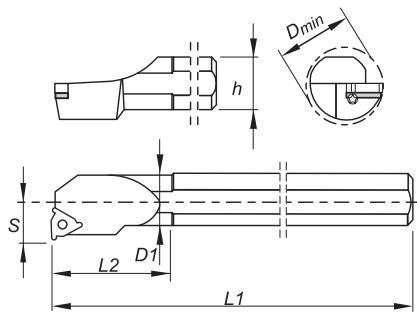

Internal Left

Order Code Código	Reference Referência Referencia	Insert Type	Dimensions Dimensões Dimensiones (mm)						Anvil	Anvil Screw	Insert Screw	Torx Key	Stock
			h	D1	Dmin	L1	L2	S					
212137600	S10H SXFN L 11	11 IL	10	10	12	100	-	7,4	-	-	P0260700	XT08	⊗
212137800	S10K SXFN L 11	11 IL	16	10	12	125	25	7,4	-	-	P0260700	XT08	○
212385300	S13L SXFN L 11	11 IL	16	13	15	140	32	8,9	-	-	P0260700	XT08	○
212138000	S13M SXFN L 16	16 IL	16	13	16	150	32	10,2	-	-	P5401391	XT10	○
212127400	S16P SXFN L 16	16 IL	20	16	19	170	40	11,7	-	-	P5401391	XT10	⊗
212138200	S20P SXFN L 16	16 IL	20	20	24	170	-	13,7	EA16	P5000790	P5401390	XT10	⊗
212125500	S25R SXFN L 16	16 IL	25	25	29	200	-	16,2	EA16	P5000790	P5401390	XT10	⊗
212125700	S32S SXFN L 16	16 IL	32	32	36	250	-	19,7	EA16	P5000790	P5401390	XT10	○
212125900	S40T SXFN L 16	16 IL	40	40	44	300	-	23,7	EA16	P5000790	P5401390	XT10	○

⊗ Stock item | Produto de stock
Itens de stock

○ Available under request | Disponível sobre consulta
Disponível bajo consulta

Note: All the toolholders SXFN are made with 1.5° helix angle. | Todos os ferros de torno são fornecidos com um ângulo de hélice de 1,5° | Todos los soportes se hacen con un ángulo de hélice de 1,5°.

Internal Right

Order Code Código	Reference Referência Referencia	Insert Type	Dimensions Dimensões Dimensiones (mm)						Anvil	Anvil Screw	Insert Screw	Torx Key	Stock
			h	D1	Dmin	L1	L2	S					
212137700	S10H SXFN R 11	11 IR	10	10	12,5	100	-	7,3	-	-	P0260700	XT08	⊗
212137900	S10K SXFN R 11	11 IR	16	10	12,5	125	25	7,3	-	-	P0260700	XT08	○
212385400	S10L SXFN R 11	11 IR	16	13	15	140	32	8,9	-	-	P0260700	XT08	○
212138100	S13M SXFN R 16	16 IR	16	13	16,5	150	32	10,4	-	-	P5401391	XT10	○
212127300	S16P SXFN R 16	16 IR	20	16	19,5	170	40	11,6	-	-	P5401391	XT10	⊗
212138400	S20P SXFN R 16	16 IR	20	20	23,5	170	-	13,6	IA16	P5000790	P5401390	XT10	⊗
212125400	S25R SXFN R 16	16 IR	25	25	28,5	200	-	16,3	IA16	P5000790	P5401390	XT10	⊗
212125600	S32S SXFN R 16	16 IR	32	32	35,5	250	-	19,6	IA16	P5000790	P5401390	XT10	○
212125800	S40T SXFN R 16	16 IR	40	40	43,5	300	-	23,6	IA16	P5000790	P5401390	XT10	○

⊗ Stock item | Produto de stock
Itens de stock

○ Available under request | Disponível sobre consulta
Disponível bajo consulta

Note: All the toolholders SXFN are made with 1.5° helix angle. | Todos os ferros de torno são fornecidos com um ângulo de hélice de 1,5° | Todos los soportes se hacen con un ángulo de hélice de 1,5°.

MAIN APPLICATIONS | Aplicações principais | Aplicaciones principales

GROOVING & PARTING OFF

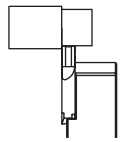

Turning

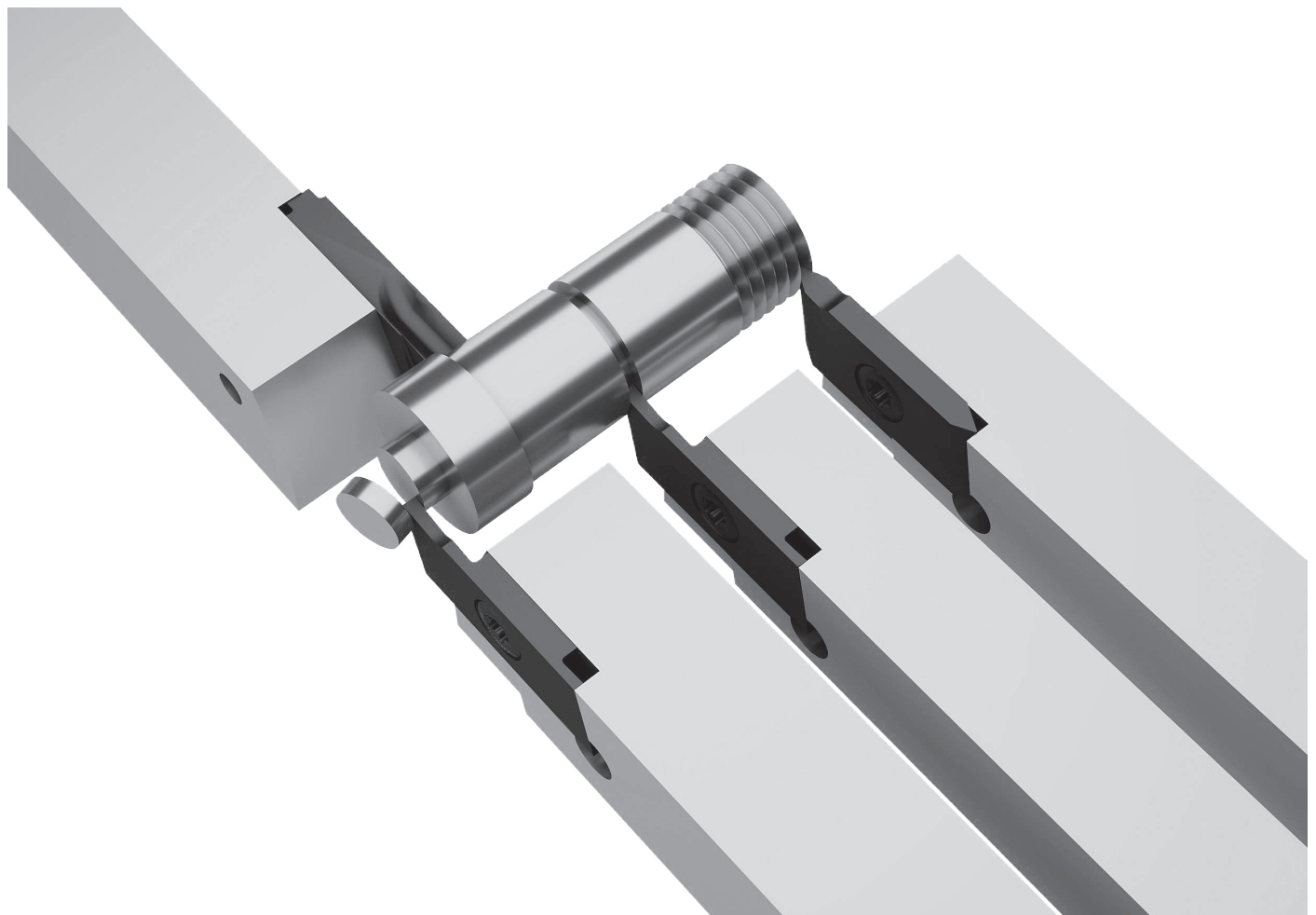

INSERTS

4 Different operations:

- Turning
- Parting off
- Grooving
- Threading

TOOLHOLDERS

Dimensions:

- 08x08mm
- 10x10mm
- 12x12mm
- 16x16mm

Grooving Plus

Grooving & Parting Off

SAL - Swiss Automatic Lathes

Light Grooving

Forming Grooving

Technical Data

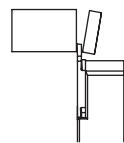

Parting off

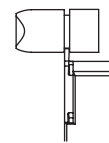

Grooving

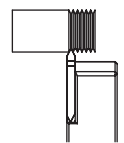

Threading



Technical Data

Forming Grooving

Light Grooving

SAL - Swiss Automatic Lathes

Grooving & Parting Off

Grooving Plus

GROOVING & PARTING OFF



SAL - SWISS AUTOMATIC LATHES

INSERTS CODE KEY - Chave de codificação para pastilhas | Llave de codificación de plaquitas

Grooving Inserts

SAL	25	G	050	R			GS
1	2	5	6	8	-		11

Parting Off Inserts

SAL	11	P	100	R	N		P07
1	3	5	6	8	9	-	11

Threading Inserts

SAL	100	H	010	R	60		PT
1	4	5	7	8	10	-	11

Turning Inserts

SAL	60	T	300	R			TP
1	2	5	6	8	-		11

1 - Product line

SAL - Swiss Automatic Lathes Line

2 - Maximum depth of cut (Turning and Grooving inserts)

25 - 2,5mm | 60 - 6,0mm

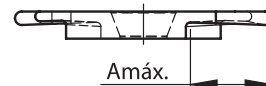

3 - Maximum Cutting Diameter (Parting Off Inserts)

11 - 11,0mm | 13 - 13,0mm

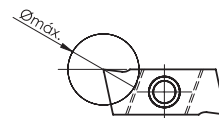

4 - Center distance (Threading Inserts)

050 - 0,5mm | 100 - 1,00mm

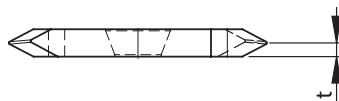

5 - Operations type

G - Grooving

P - Parting off

H - Threading

T - Turning

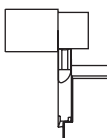
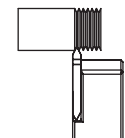
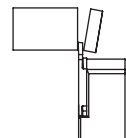
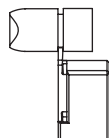

6 - Cut thickness (Grooving, Parting Off and Turning Inserts)

050 - 0,50mm | 070 - 0,70mm | 080 - 0,80mm
090 - 0,90mm | 100 - 1,00mm | 110 - 1,10mm
130 - 1,30mm | 150 - 1,50mm | 160 - 1,60mm
185 - 1,85mm | 200 - 2,00 mm | 300 - 3,00 mm

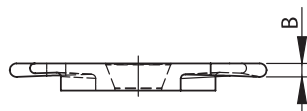

7 - Corner radius (Threading Inserts)

005 - 0,05mm | 010 - 0,10mm
012 - 0,12mm

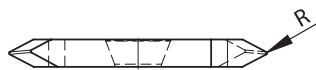

8 - Insert / toolholder side

L - Left hand

R - Right hand



9 - Front angle (Parting off)

N - Neutral

R - Right

L - Left



10 - Angle (Threading Inserts)

55 - 55° | 60 - 60°

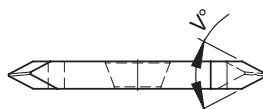

11 - Chip Breaker (Turning, Grooving, Parting Off and Threading Inserts)

Turning

TP - Turning steel

Grooving

GS - Square Grooving
GR - Round Grooving

Parting Off

P00 - Front angle 0°
P07 - Front angle 7°

Threading

PT - Partial Profile

TOOLHOLDERS CODE KEY - Chave de codificação para suportes | Llave de codificación de herramienta

SAL	H	E	R	-	08	08	-	M	07
1	2	3	4		5	6		7	8

1 - Product line
SAL - Swiss Automatic Lathes Line

2 - Tool type
H - Holder

3 - Internal or External
E - External

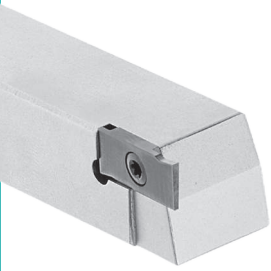
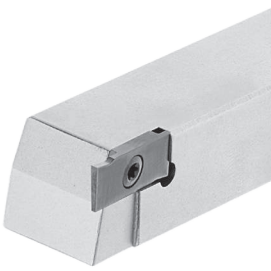
4 - Insert / toolholder side	
L - Left hand	R - Right hand
	

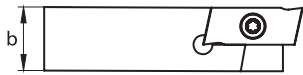
5 - Shank height
08 - 8 mm
10 - 10 mm
12 - 12 mm
16 - 16 mm

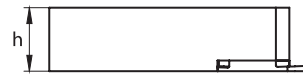
6 - Shank width
08 - 8 mm
10 - 10 mm
12 - 12 mm
16 - 16 mm

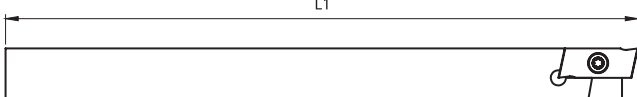
7 - Shank height
L - 140 mm
M - 150 mm

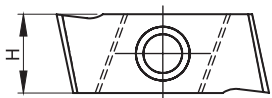
8 - Insert cutting edge length (mm)
07 - 7,0 mm

SAL - SWISS AUTOMATIC LATHES

EXTERNAL TOOLHOLDERS | Suportes exteriores | herramientas de tronzado exterior



Left hand style show

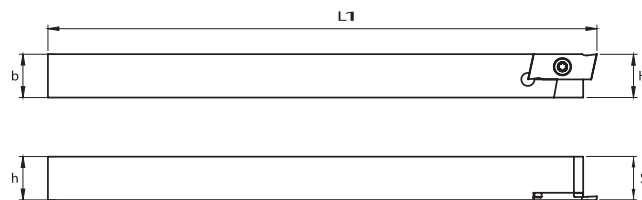

Order code Código	Reference Referência Referencia	Dimensions Dimensões Dimensiones (mm)					* Insert	Screw	Wrench	Stock
		h	b	H	L1	S				
213023600	SALHEL 0808 M07	8,00	8,00	8,00	150,00	8,00	SAL...L	P0300900	XT 08	☺
213023700	SALHEL 1010 M07	10,00	10,00	10,00	150,00	10,00	SAL...L	P0300900	XT 08	☺
213023800	SALHEL 1212 M07	12,00	12,00	12,00	150,00	12,00	SAL...L	P0300900	XT 08	☺
213023900	SALHEL 1616 M07	16,00	16,00	16,00	150,00	16,00	SAL...L	P0300900	XT 08	☺
213029700	SALHEL 2020 M07	20,00	20,00	20,00	150,00	20,00	SAL...L	P0300900	XT 08	☺
213029900	SALHEL 2525 M07	25,00	25,00	25,00	150,00	25,00	SAL...L	P0300900	XT 08	☺

☺ Stock item | Produto de stock | Itens de stock

○ Available under request | Disponível sobre consulta | Disponible bajo consulta

* Left insert only fits on left toolholder



Right hand style show

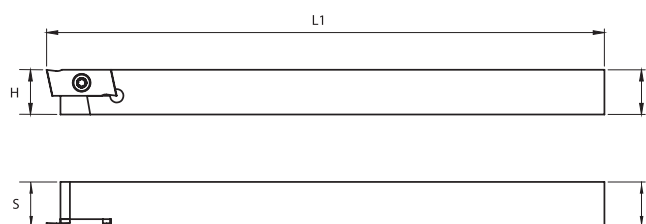

Order code Código	Reference Referência Referencia	Dimensions Dimensões Dimensiones (mm)					* Insert	Screw	Wrench	Stock
		h	b	H	L1	S				
213023200	SALHER 0808 M07	8,00	8,00	8,00	150,00	8,00	SAL...R	P0300900	XT 08	☺
213023300	SALHER 1010 M07	10,00	10,00	10,00	150,00	10,00	SAL...R	P0300900	XT 08	☺
213023400	SALHER 1212 M07	12,00	12,00	12,00	150,00	12,00	SAL...R	P0300900	XT 08	☺
213023500	SALHER 1616 M07	16,00	16,00	16,00	150,00	16,00	SAL...R	P0300900	XT 08	☺
213025300	SALHER 2020 M07	20,00	20,00	20,00	150,00	20,00	SAL...R	P0300900	XT 08	☺
213029800	SALHER 2525 M07	25,00	25,00	25,00	150,00	25,00	SAL...R	P0300900	XT 08	☺

☺ Stock item | Produto de stock | Itens de stock

○ Available under request | Disponível sobre consulta | Disponible bajo consulta

* Right insert only fits on right toolholder

GS SERIES | Inserts | Pastilhas | Plaquetas



Right hand style show

For square grooving
Para grooveing quadrado
Para ranurado quadrado

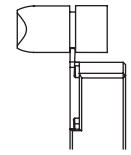
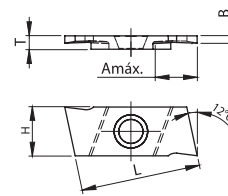

Grooving

(1) Geometry code	(2) Grade code		PVD								Dimensions (mm) Dimensões (mm) Dimensiones (mm)						Cutting conditions Condições de corte Condiciones de corte			
			P		M		K		S		B	L	T	H	Amáx.	V°	Ømáx.	fn (mm/r)	Min.	Max.
			G1	G4	G4	P8	G4	P8	G4	P8										
1130441	SAL25G050R-GS	SAL25G050R-GS	○	⊗	⊗	○	⊗	○	⊗	○	0,50	17,00	2,00	7,00	2,50	-	-	0,04	0,02	0,06
1130475	SAL25G070R-GS	SAL25G070R-GS	○	⊗	⊗	○	⊗	○	⊗	○	0,70	17,00	2,00	7,00	2,50	-	-	0,05	0,02	0,08
1130477	SAL25G080R-GS	SAL25G080R-GS	○	⊗	⊗	○	⊗	○	⊗	○	0,80	17,00	2,00	7,00	2,50	-	-	0,05	0,02	0,09
1130479	SAL25G090R-GS	SAL25G090R-GS	○	⊗	⊗	○	⊗	○	⊗	○	0,90	17,00	2,00	7,00	2,50	-	-	0,06	0,02	0,10
1130488	SAL60G110R-GS	SAL60G110R-GS	○	⊗	⊗	○	⊗	○	⊗	○	1,10	17,00	2,00	7,00	6,00	-	-	0,06	0,02	0,11
1130490	SAL60G130R-GS	SAL60G130R-GS	○	⊗	⊗	○	⊗	○	⊗	○	1,30	17,00	2,00	7,00	6,00	-	-	0,07	0,02	0,12
1130442	SAL60G160R-GS	SAL60G160R-GS	○	⊗	⊗	○	⊗	○	⊗	○	1,60	17,00	2,00	7,00	6,00	-	-	0,07	0,02	0,13
1130495	SAL60G185R-GS	SAL60G185R-GS	○	⊗	⊗	○	⊗	○	⊗	○	1,85	17,00	2,00	7,00	6,00	-	-	0,08	0,02	0,14
1130473	SAL25G050L-GS	SAL25G050L-GS	○	⊗	⊗	○	⊗	○	⊗	○	0,50	17,00	2,00	7,00	2,50	-	-	0,04	0,02	0,06
1130474	SAL25G070L-GS	SAL25G070L-GS	○	⊗	⊗	○	⊗	○	⊗	○	0,70	17,00	2,00	7,00	2,50	-	-	0,05	0,02	0,08
1130476	SAL25G080L-GS	SAL25G080L-GS	○	⊗	⊗	○	⊗	○	⊗	○	0,80	17,00	2,00	7,00	2,50	-	-	0,05	0,02	0,09
1130478	SAL25G090L-GS	SAL25G090L-GS	○	⊗	⊗	○	⊗	○	⊗	○	0,90	17,00	2,00	7,00	2,50	-	-	0,06	0,02	0,10
1130487	SAL60G110L-GS	SAL60G110L-GS	○	⊗	⊗	○	⊗	○	⊗	○	1,10	17,00	2,00	7,00	6,00	-	-	0,06	0,02	0,11
1130489	SAL60G130L-GS	SAL60G130L-GS	○	⊗	⊗	○	⊗	○	⊗	○	1,30	17,00	2,00	7,00	6,00	-	-	0,07	0,02	0,12
1130493	SAL60G160L-GS	SAL60G160L-GS	○	⊗	⊗	○	⊗	○	⊗	○	1,60	17,00	2,00	7,00	6,00	-	-	0,07	0,02	0,13
1130494	SAL60G185L-GS	SAL60G185L-GS	○	⊗	⊗	○	⊗	○	⊗	○	1,85	17,00	2,00	7,00	6,00	-	-	0,08	0,02	0,14

⊗ Stock item | Produto de stock | Itens de stock

○ Available under request with delivery time 4 weeks
Disponível sobre consulta com prazo de entrega de 4 semanas
Disponible bajo consulta, con fecha de entrega en 4 semanas

Order code = (1) Geometry code + (2) Grade code

GR SERIES | Inserts | Pastilhas | Plaquetas

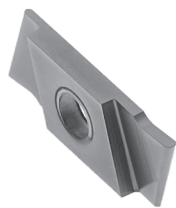

Right hand style show

For round grooving
Para grooveing redondo
Para ranurado redondo

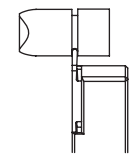
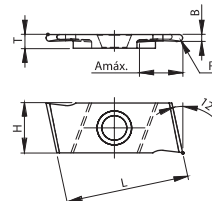

Grooving

(1) Geometry code	(2) Grade code		PVD								Dimensions (mm) Dimensões (mm) Dimensiones (mm)						Cutting conditions Condições de corte Condiciones de corte			
			P		M		K		S		B	L	T	H	Amáx.	V°	Ømáx.	fn (mm/r)	Min.	Max.
			G1	G4	G4	P8	G4	P8	G4	P8										
1130443	SAL60G100R-GR	SAL60G100R-GR	○	⊗	⊗	○	⊗	○	⊗	○	1,00	17,00	2,00	7,00	6,00	-	-	0,06	0,02	0,10
1130492	SAL60G150R-GR	SAL60G150R-GR	○	⊗	⊗	○	⊗	○	⊗	○	1,50	17,00	2,00	7,00	6,00	-	-	0,08	0,02	0,12
1130497	SAL60G200R-GR	SAL60G200R-GR	○	⊗	⊗	○	⊗	○	⊗	○	2,00	17,00	2,00	7,00	6,00	-	-	0,08	0,03	0,14
1130486	SAL60G100L-GR	SAL60G100L-GR	○	⊗	⊗	○	⊗	○	⊗	○	1,00	17,00	2,00	7,00	6,00	-	-	0,06	0,02	0,10
1130491	SAL60G150L-GR	SAL60G150L-GR	○	⊗	⊗	○	⊗	○	⊗	○	1,50	17,00	2,00	7,00	6,00	-	-	0,08	0,02	0,12
1130496	SAL60G200L-GR	SAL60G200L-GR	○	⊗	⊗	○	⊗	○	⊗	○	2,00	17,00	2,00	7,00	6,00	-	-	0,08	0,03	0,14

SAL - SWISS AUTOMATIC LATHES

P(P00) SERIES | Inserts | Pastilhas | Plaquetas

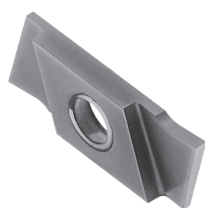

Right hand style show

Without front angle
Sem ângulo frontal
Sin ángulo frontal

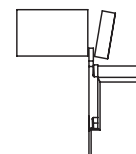
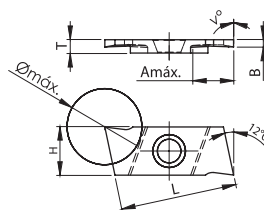

Parting off

(1) Geometry code	ISO Reference	ANSI Reference	PVD								Dimensions (mm) Dimensões (mm) Dimensiones (mm)					Cutting conditions Condições de corte Condiciones de corte				
			(2) Grade code								B	L	T	H	Amáx.	V°	Ømáx.	fn (mm/r)	Min.	Max.
			G1	G4	G4	P8	G4	P8	G4	P8										
			PH7910	PH7920	PH7920	PH7135	PH7920	PH7135	PH7920	PH7135										
1130444	SAL11P100RN-P00	SAL11P100RN-P00	○	⊗	⊗	○	⊗	○	⊗	○	1,00	17,00	2,00	7,00	6,00	0	11,00	0,06	0,02	0,10
1130462	SAL11P150RN-P00	SAL11P150RN-P00	○	⊗	⊗	○	⊗	○	⊗	○	1,50	17,00	2,00	7,00	6,00	0	11,00	0,08	0,02	0,12
1130468	SAL13P200RN-P00	SAL13P200RN-P00	○	⊗	⊗	○	⊗	○	⊗	○	2,00	17,00	2,00	7,00	6,00	0	7,00	0,08	0,03	0,14
1130456	SAL11P100LN-P00	SAL11P100LN-P00	○	⊗	⊗	○	⊗	○	⊗	○	1,00	17,00	2,00	7,00	6,00	0	11,00	0,06	0,02	0,10
1130459	SAL11P150LN-P00	SAL11P150LN-P00	○	⊗	⊗	○	⊗	○	⊗	○	1,50	17,00	2,00	7,00	6,00	0	11,00	0,08	0,02	0,12
1130465	SAL13P200LN-P00	SAL13P200LN-P00	○	⊗	⊗	○	⊗	○	⊗	○	2,00	17,00	2,00	7,00	6,00	0	7,00	0,08	0,03	0,14

⊗ Stock item | Produto de stock | Itens de stock

○ Available under request with delivery time 4 weeks
Disponível sobre consulta com prazo de entrega de 4 semanas
Disponibile bajo consulta, con fecha de entrega en 4 semanas

Order code = (1) Geometry code + (2) Grade code

P(P07) SERIES | Inserts | Pastilhas | Plaquetas

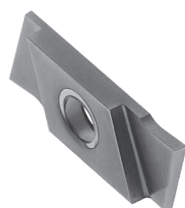

Right hand style show

Front angle 7°
Ângulo frontal de 7°
Angulo frontal de 7°

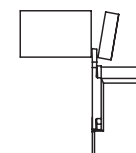
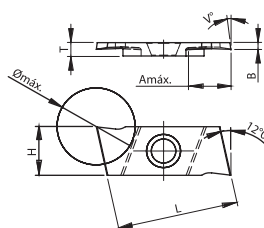

Parting off

(1) Geometry code	ISO Reference	ANSI Reference	PVD								Dimensions (mm) Dimensões (mm) Dimensiones (mm)					Cutting conditions Condições de corte Condiciones de corte				
			(2) Grade code								B	L	T	H	Amáx.	V°	Ømáx.	fn (mm/r)	Min.	Max.
			G1	G4	G4	P8	G4	P8	G4	P8										
			PH7910	PH7920	PH7920	PH7135	PH7920	PH7135	PH7920	PH7135										
1130445	SAL11P100RR-P07	SAL11P100RR-P07	○	⊗	⊗	○	⊗	○	⊗	○	1,00	17,00	2,00	7,00	6,00	7	11,00	0,05	0,02	0,08
1130446	SAL11P100RL-P07	SAL11P100RL-P07	○	⊗	⊗	○	⊗	○	⊗	○	1,00	17,00	2,00	7,00	6,00	7	11,00	0,05	0,02	0,08
1130463	SAL11P150RR-P07	SAL11P150RR-P07	○	⊗	⊗	○	⊗	○	⊗	○	1,50	17,00	2,00	7,00	6,00	7	11,00	0,06	0,02	0,10
1130461	SAL11P150RL-P07	SAL11P150RL-P07	○	⊗	⊗	○	⊗	○	⊗	○	1,50	17,00	2,00	7,00	6,00	7	11,00	0,06	0,02	0,10
1130469	SAL13P200RR-P07	SAL13P200RR-P07	○	⊗	⊗	○	⊗	○	⊗	○	2,00	17,00	2,00	7,00	6,00	7	7,00	0,06	0,03	0,12
1130467	SAL13P200RL-P07	SAL13P200RL-P07	○	⊗	⊗	○	⊗	○	⊗	○	2,00	17,00	2,00	7,00	6,00	7	7,00	0,06	0,03	0,12
1130457	SAL11P100LR-P07	SAL11P100LR-P07	○	⊗	⊗	○	⊗	○	⊗	○	1,00	17,00	2,00	7,00	6,00	7	11,00	0,05	0,02	0,08
1130455	SAL11P100LL-P07	SAL11P100LL-P07	○	⊗	⊗	○	⊗	○	⊗	○	1,00	17,00	2,00	7,00	6,00	7	11,00	0,05	0,02	0,08
1130460	SAL11P150LR-P07	SAL11P150LR-P07	○	⊗	⊗	○	⊗	○	⊗	○	1,50	17,00	2,00	7,00	6,00	7	11,00	0,06	0,02	0,10
1130458	SAL11P150LL-P07	SAL11P150LL-P07	○	⊗	⊗	○	⊗	○	⊗	○	1,50	17,00	2,00	7,00	6,00	7	11,00	0,06	0,02	0,10
1130466	SAL13P200LR-P07	SAL13P200LR-P07	○	⊗	⊗	○	⊗	○	⊗	○	2,00	17,00	2,00	7,00	6,00	7	7,00	0,06	0,03	0,12
1130464	SAL13P200LL-P07	SAL13P200LL-P07	○	⊗	⊗	○	⊗	○	⊗	○	2,00	17,00	2,00	7,00	6,00	7	7,00	0,06	0,03	0,12

⊗ Stock item | Produto de stock | Itens de stock

○ Available under request with delivery time 4 weeks
Disponível sobre consulta com prazo de entrega de 4 semanas
Disponibile bajo consulta, con fecha de entrega en 4 semanas

Order code = (1) Geometry code + (2) Grade code

PT SERIES | Inserts | Pastilhas | Plaquetas

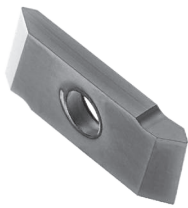

Right hand style show

For partial profile threading
Para perfil parcial de roscagem
Para perfil parcial de roscado

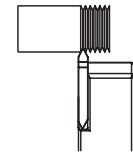
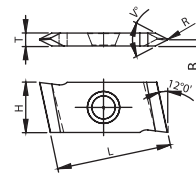

Threading

(1) Geometry code	(2) Grade code		PVD								Dimensions (mm) Dimensões (mm) Dimensiones (mm)						Cutting conditions Condições de corte Condiciones de corte			
			P M K S								B	L	T	H	Amáx.	V°	Ømáx.	fn (mm/r)	Min.	Max.
			G1	G4	G4	P8	G4	P8	G4	P8										
1130472	SAL100H012R55-PT	SAL100H012R55-PT	○	⊗	⊗	○	⊗	○	⊗	○	1,09	1700	2,00	7,00	0,12	55	-	0,80	0,20	2,00
1130447	SAL100H012R60-PT	SAL100H012R60-PT	○	⊗	⊗	○	⊗	○	⊗	○	1,09	1700	2,00	7,00	0,12	60	-	0,80	0,20	2,00
1130470	SAL100H012L55-PT	SAL100H012L55-PT	○	⊗	⊗	○	⊗	○	⊗	○	1,09	1700	2,00	7,00	0,12	55	-	0,80	0,20	2,00
1130471	SAL100H012L60-PT	SAL100H012L60-PT	○	⊗	⊗	○	⊗	○	⊗	○	1,09	1700	2,00	7,00	0,12	60	-	0,80	0,20	2,00

⊗ Stock item | Produto de stock | Itens de stock

○ Available under request with delivery time 4 weeks
Disponível sobre consulta com prazo de entrega de 4 semanas
Disponible bajo consulta, con fecha de entrega en 4 semanas

Order code = (1) Geometry code + (2) Grade code

TP SERIES | Inserts | Pastilhas | Plaquetas

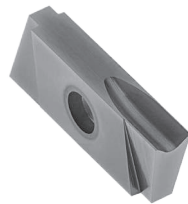

Right hand style show

For turning
Para torneamento
Para torneado

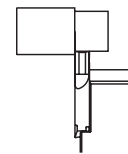
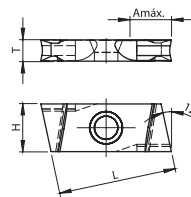

Turning

(1) Geometry code	(2) Grade code		PVD								Dimensions (mm) Dimensões (mm) Dimensiones (mm)						Cutting conditions Condições de corte Condiciones de corte			
			P M K S								B	L	T	H	Amáx.	V°	Ømáx.	fn (mm/r)	Min.	Max.
			G1	G4	G4	P8	G4	P8	G4	P8										
1130501	SAL60T300R-TP	SAL60T300R-TP	○	⊗	⊗	○	⊗	○	⊗	○	-	1700	3,17	7,00	6,00	-	-	0,08	0,02	0,12
1130499	SAL60T300L-TP	SAL60T300L-TP	○	⊗	⊗	○	⊗	○	⊗	○	-	1700	3,17	7,00	6,00	-	-	0,08	0,02	0,12

⊗ Stock item | Produto de stock | Itens de stock

○ Available under request with delivery time 4 weeks
Disponível sobre consulta com prazo de entrega de 4 semanas
Disponible bajo consulta, con fecha de entrega en 4 semanas

Order code = (1) Geometry code + (2) Grade code

BLANKS FOR GRINDING | Blanks para personalizar | Blanks para personalizar



Right hand style show

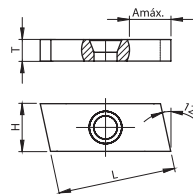

Inserts blanks “do it yourself” grinding are available allowing modifications of the insert for any machining operation.

As pastilhas de blank “faça você mesmo” permitem a personalização da pastilha para qualquer operação de maquinação.

Las plaquetas de blank “haga usted mismo” permiten la personalización de la plaqueta para cualquiera operación de maquinación.

(1) Geometry code	(2) Grade code		Uncoated			Dimensions (mm) Dimensões (mm) Dimensiones (mm)						
			10	12	14	B	L	T	H	Amáx.	V°	Ømáx.
			PH0910	PH0920	PH0135							
1130440	BLANK SALR 17x7x2	BLANK SALR 17x7x2	⊗	⊗	⊗	-	1750	2,00	750	-	-	-
1130504	BLANK SALR 17x7x3,17	BLANK SALR 17x7x3,17	⊗	⊗	⊗	-	1750	3,17	750	-	-	-
1130453	BLANK SALL 17x7x2	BLANK SALL 17x7x2	⊗	⊗	⊗	-	1750	2,00	750	-	-	-
1130505	BLANK SALL 17x7x3,17	BLANK SALL 17x7x3,17	⊗	⊗	⊗	-	1750	3,17	750	-	-	-

⊗ Stock item | Produto de stock | Itens de stock

○ Available under request | Disponível sobre consulta | Disponible bajo consulta

Order code = (1) Geometry code + (2) Grade code

SAL - SWISS AUTOMATIC LATHES

GROOVING | Canais | Ranurado

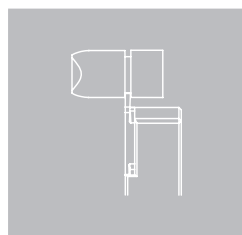

- High precision
- Close tolerances
- Wide variety of insert widths

GS

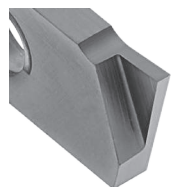

Square grooving

GR

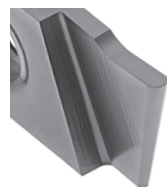

Round grooving

Recommended cutting conditions

P	M	K	S
60-200	60-180	60-150	20-50

Recommended grade PH7920, (Vc) m/min.

Grade PH7910 and PH7135

Available under request (4 weeks delivery time)

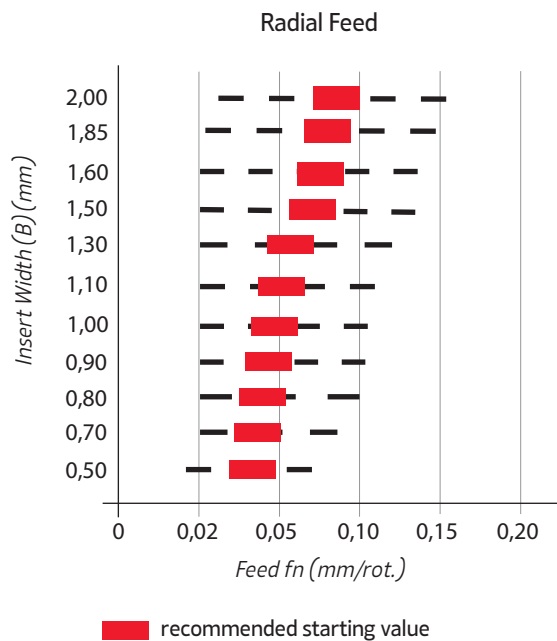

PARTING OFF | Corte | Tronzado

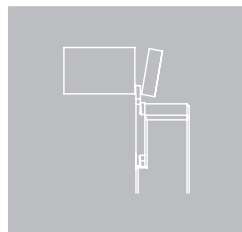

- When parting off with a sub-spindle, it is more productive to use a straight cutting edge. This is a more stable parting method and will generate the best surface finish.
- When parting off without a sub-spindle, we recommend you use an insert with a maximum 7° front angle to minimize the risk of burr and pips on the component.
- When parting off with 7° front angled inserts, we recommend reducing the feed rate by approximately 30%.

P00



0° Relief angle

P07

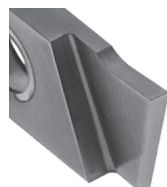

7° Relief angle

Recommended cutting conditions

P	M	K	S
60-200	60-180	60-150	20-50

Recommended grade PH7920, (Vc) m/min.

Grade PH7910 and PH7135

Available under request (4 weeks delivery time)

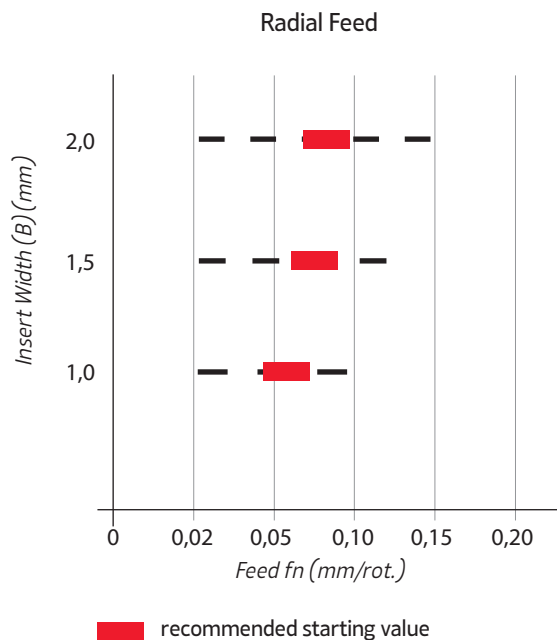

THREADING || Roscagem | Roscado

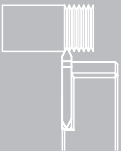

Two types of threading:

- Partial profile 55°
- Partial profile 60°

Pitch from 12 - 94 TPI / 0,25 - 2,0 mm

PT



Partial profile

Recommended cutting conditions

P	M	K	S
60-200	60-180	60-150	20-50

Recommended grade PH7920, (Vc) m/min.

Grade PH7910 and PH7135

Available under request (4 weeks delivery time)

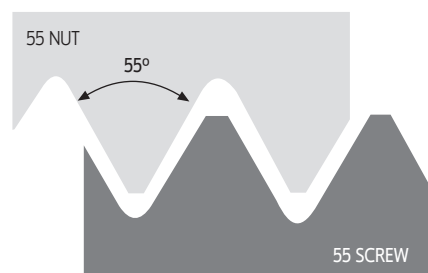
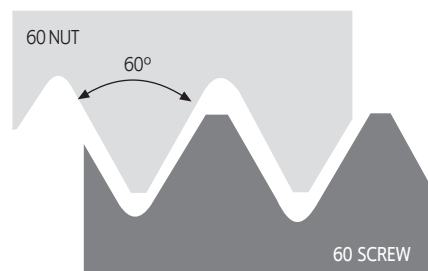

TURNING || Torneamento | Torneado

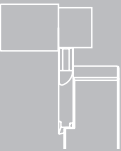

- Insert for turning
- Maximum deep of cut is 2,50 mm
- Too low cutting speed will result in inadequate tool life and it is advisable to follow cutting speed recommendations.

TP

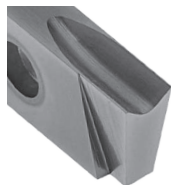

Turning steel

Recommended cutting conditions

P	M	K	S
60-200	60-180	60-150	20-50

Recommended grade PH7920, (Vc) m/min.

Grade PH7910 and PH7135

Available under request (4 weeks delivery time)

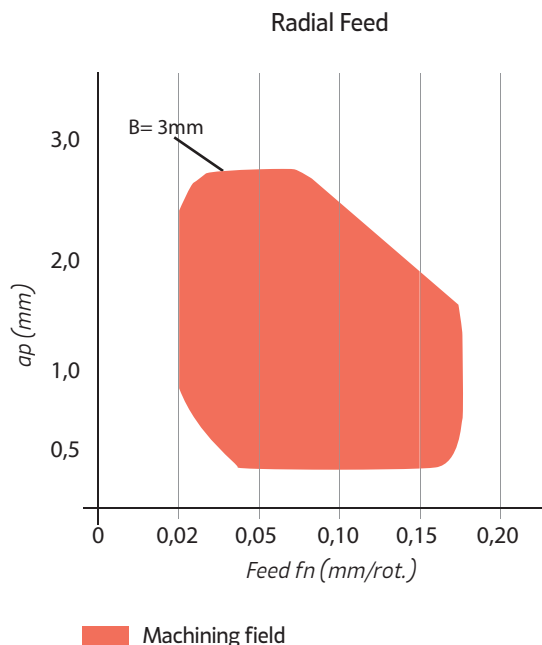

LIGHT GROOVING NEW



GROOVING & PARTING OFF

Grooving Plus

Grooving & Parting Off

SAL - Swiss Automatic Lathes

Light Grooving

Forming Grooving

Technical Data



INSERTS | Pastilhas | Plaquetas

LG	06	02	R	110
1	2	3	4	5

1 - Product Line Ligne de produits Produktlinie
LG - Light Grooving
2 - Insert size
06 - IC=6,35mm
3 - Cutting edges
02 - 2 cutting edges
4 - Work side
R - Right L - Left
5 - Edge width
110=1,1mm

TOOLHOLDERS | Suportes | Herramientas

LG	H	06	02	I	R	150	16
1	2	3	4	5	6	7	8

1 - Product Line
LG - Light Grooving
2 - Product type
H - Holder
3 - Insert size
06 - IC=6,35mm
4 - Cutting edges
02 - 2 Cutting edges
5 - Internal / External
I - Internal E - External
6 - Work side
R - Right L - Left
7 - Tool length
150 - 150mm
8 - Shank dimension
Internal: 16 - Ø16mm External: 2020 - 20mm x 20mm

LGH-ER/L



R	L	Reference Referência Referencia	Dimensions Dimensões Dimensiones (mm)					Insert
			h	b1	L1	L2	f	
113063500	113062700	LGH 0602-ER/L 100 1616	16	16	100	21	20	LG 0602
113063600	113062800	LGH 0602-ER/L 125 2020	20	20	125	25	25	LG 0602
113063700	113062900	LGH 0602-ER/L 150 2525	25	25	150	32	32	LG 0602

LGH-IR/L

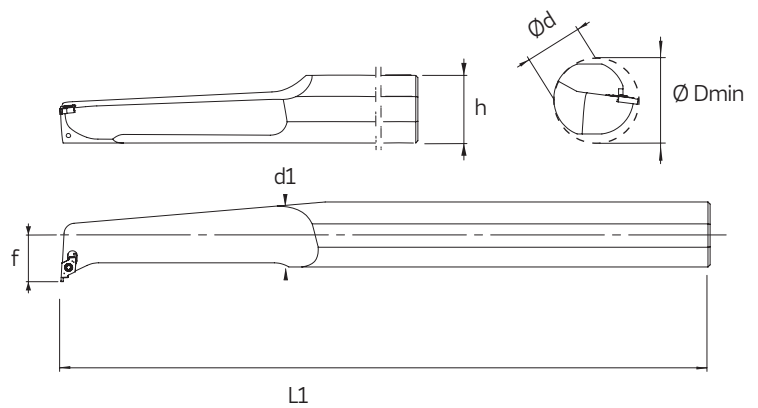

R	L	Reference Referência Referencia	Dimensions Dimensões Dimensiones (mm)					Insert	ØDmin
			Ød	h	d1	L1	f		
113063800	113063000	LGH 0602-IR/L 150 12	12	11	11,5	150	9	LG 0602	16
113063900	113063100	LGH 0602-IR/L 150 16	16	15	15	150	11	LG 0602	20
113064000	113063200	LGH 0602-IR/L 170 20	20	18	19	170	13	LG 0602	25
113064100	113063300	LGH 0602-IR/L 200 25	25	23	24	200	17	LG 0602	32
113064200	113063400	LGH 0602-IR/L 300 32	32	30	31	300	22	LG 0602	40

LG-R

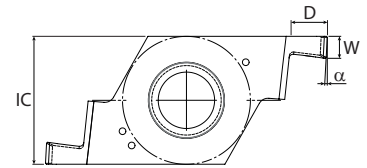
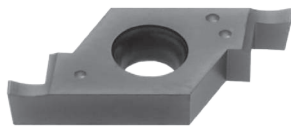

Code	Reference Referência Referencia	Dimensions Dimensões Dimensiones (mm)				For circlip widht	Stock
		IC	α	W	D		PH7920
1130597G4	LG 0602R110	6,35	3	1,10	0,8	1,0	☉
1130598G4	LG 0602R130	6,35	3	1,30	1,4	1,2	☉
1130599G4	LG 0602R160	6,35	3	1,60	1,7	1,5	☉
1130600G4	LG 0602R185	6,35	3	1,85	2,0	1,75	☉
1130601G4	LG 0602R215	6,35	3	2,15	2,4	2,0	☉
1130602G4	LG 0602R265	6,35	3	2,65	2,7	2,5	☉
1130603G4	LG 0602R300	6,35	3	3,00	3,0	-	☉
1130604G4	LG 0602R315	6,35	3	3,15	3,0	3,0	☉

☉ Stock item | Article en stock | Lagerware

○ Available under request | Disponible sur demande | Verfügbar auf Anfrage

LG-L

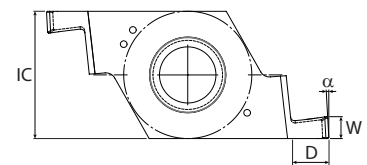
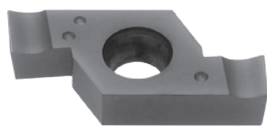

Code	Reference Referência Referencia	Dimensions Dimensões Dimensiones (mm)				For circlip widht	Stock
		IC	α	W	D		PH7920
1130589G4	LG 0602L110	6,35	3	1,10	0,8	1,0	☉
1130590G4	LG 0602L130	6,35	3	1,30	1,4	1,2	☉
1130591G4	LG 0602L160	6,35	3	1,60	1,7	1,5	☉
1130592G4	LG 0602L185	6,35	3	1,85	2	1,75	☉
1130593G4	LG 0602L215	6,35	3	2,15	2,4	2,0	☉
1130594G4	LG 0602L265	6,35	3	2,65	2,7	2,5	☉
1130595G4	LG 0602L300	6,35	3	3,00	3	-	☉
1130596G4	LG 0602L315	6,35	3	3,15	3	3,0	☉

☉ Stock item | Article en stock | Lagerware

○ Available under request | Disponible sur demande | Verfügbar auf Anfrage

BLANKS



1 - Product Line

FG - Forming Grooving

2 - Product type

I - Insert

3 - Edge width (W)

13 - 13mm

16 - 16mm

20 - 20mm

32 - 32mm





1 - Product Line		2 - Cutting Width	
FG - Forming Grooving		H - Holder	
3 - Edge Width (Forming)			
		13 - 13 mm	
		16 - 16 mm	
		20 - 20 mm	
		32 - 32 mm (2 holes)	
4 - Toolholder Type (Forming)			
Type A	Type B	Type C	Type C
5 - Toolholder total length			
		125 - 125 mm	
		150 - 150 mm	
6 - Toolholder depth			
		10 - 10 mm	
		12 - 12 mm	
		14 - 14 mm	
		16 - 16 mm	
		20 - 20 mm	
7 - Insert height			
		10 - 10 mm	
		12 - 12 mm	
		14 - 14 mm	
		16 - 16 mm	
		25 - 25 mm	
8 - Insert relief angle			
		0°	
		5°	

FORMING GROOVING

BLANKS & TOOLHOLDERS

FGI

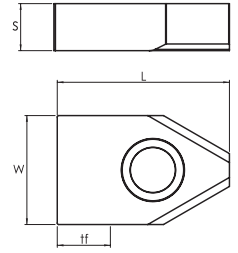

(1) Geometry code	(2) Grade code	UNC PH0930	Dimensions			
			W	S	L	tf
1130550	BLANK FGI 13	☉	13	5,35	20,70	6,00
1130551	BLANK FGI 16	☉	16	5,35	25,00	10,00
1130552	BLANK FGI 20	☉	20	6,35	20,70	7,00
1130615	BLANK FGI 20 L	☉	20	6,35	25	11,00

☉ Stock item

○ Available under request

Insert order code = (1) Geometry Code + (2) Grade Code

Type A

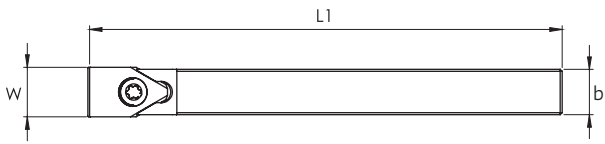

Type B

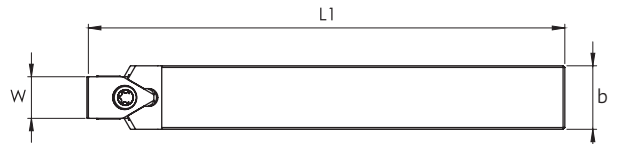

Type C

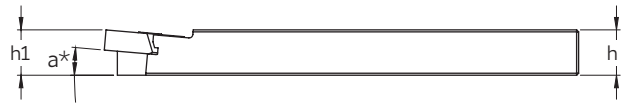

Order code		ISO Reference	Dimensions					Insert	Toolholder Type	Stock	
*a 0°	*a 5°		h	h1	b	L1	W			0°	5°
113056500	113055400	FGH 13-A 125 12.12 - 0°/5°	12	12	12	125	13	FGI 13	A	☉	☉
113056600	113055500	FGH 13-B 125 14.14 - 0°/5°	14	14	14	125	13	FGI 13	B	☉	☉
113058000	113058100	FGH 13-B 125 16.16-0°/5°	16	16	16	125	13	FGI 13	B	○	☉
113056700	113055600	FGH 13-C 125 10.10 - 0°/5°	10	10	10	125	13	FGI 13	C	○	☉
113056800	113055700	FGH 16-A 125 16.16 - 0°/5°	16	16	16	125	16	FGI 16	A	☉	☉
113056900	113055800	FGH 16-B 150 20.20 - 0°/5°	20	20	20	150	16	FGI 16	B	☉	☉
113057000	113055900	FGH 16-C 125 14.14 - 0°/5°	14	14	14	125	16	FGI 16	C	☉	☉
113057100	113056000	FGH 20-A 150 20.20 - 0°/5°	20	20	20	150	20	FGI 20	A	○	☉
113057200	113056100	FGH 20-C 125 16.16 - 0°/5°	16	16	16	125	20	FGI 20	C	○	☉
113061600	113061700	FGH 20L-A 150 20.20-0°/5°	20	20	20	150	20	FGI 20 L	A	☉	☉
113061800	113061900	FGH 20L-C 125 16.16-0°/5°	16	16	16	125	20	FGI 20 L	C	☉	☉

☉ Stock item

○ Available under request

FGI

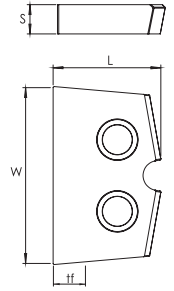

(1) Geometry code	(2) Grade code	UNC	Dimensions (mm)			
			W	S	L	tf
1130553	BLANK FGI 32	PH0930	32	5,00	19,80	7,00

Stock item

Available under request

Insert order code = (1) Geometry Code + (2) Grade Code

Type C

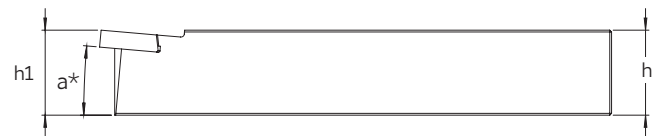
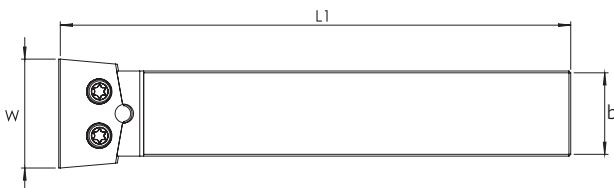

Order code		ISO Reference	Dimensions (mm)					Insert	Toolholder Type	Stock	
*a 0°	*a 5°		h	h1	b	L1	W			0°	5°
113057300	113056200	FGH 32-C 150 25.25 - 0°/5°	25	25	25	150	32	FGI 32	C	<input type="checkbox"/>	<input checked="" type="checkbox"/>

Stock item

Available under request

SCREWS & KEYS



Screws

Order code Código	Reference Referência Referencia	Stock
290074100	D0503000	<input checked="" type="checkbox"/>
290020700	D0603600	<input checked="" type="checkbox"/>
290062900	D0602200	<input checked="" type="checkbox"/>
290087400	D0602600	<input checked="" type="checkbox"/>
290087500	D0603100	<input checked="" type="checkbox"/>
290044800	P0260700	<input checked="" type="checkbox"/>
290044600	P5401390	<input checked="" type="checkbox"/>
290044900	P5401391	<input checked="" type="checkbox"/>

Keys

Order Code Código	Reference Referência Referencia	Stock
290011700	XT08	<input checked="" type="checkbox"/>
290013100	XT10	<input checked="" type="checkbox"/>

Stock item | Produto de stock | Itens de stock

Available under request | Disponível sobre consulta | Disponible bajo consulta

WRENCHES



Order code Código	Reference Referência Referencia	Stock
290021200	SS40	<input checked="" type="checkbox"/>
290021300	SS50	<input checked="" type="checkbox"/>

Order code Código	Reference Referência Referencia	Stock
290074400	LE05	<input checked="" type="checkbox"/>

Order code Código	Reference Referência Referencia	Stock
290079600	LE25-30	<input checked="" type="checkbox"/>

Stock item | Produto de stock | Itens de stock

Available under request | Disponível sobre consulta | Disponible bajo consulta

GROOVING & PARTING OFF GRADES | Graus para Sangramento | Calidades para Tronzado

	1	5	10	15	20	25	30	35	40	45	50		
P STEEL	PH5115			PH5125			PH5135			PHS135 <small>NEW</small>			CVD
	PH7920			PHP920 <small>NEW</small>			PHP930 <small>NEW</small>						
				PHS135 <small>NEW</small>									
				PH7920			PHP920 <small>NEW</small>			PHP930 <small>NEW</small>			
				PHS135 <small>NEW</small>									
				PH7920			PHP920 <small>NEW</small>			PHP930 <small>NEW</small>			
M STAINLESS SEEL				PHS135 <small>NEW</small>									PVD
				PH7920			PHP920 <small>NEW</small>			PHP930 <small>NEW</small>			
				PHS135 <small>NEW</small>									
				PH7920			PHP920 <small>NEW</small>			PHP930 <small>NEW</small>			
K CAST IRON	PH5705		PH5320		PH5135		PHS135 <small>NEW</small>					CVD	
	PH5705		PH5320		PH5135		PHS135 <small>NEW</small>						
	PH5705		PH5320		PH5135		PHS135 <small>NEW</small>						
	PH5705		PH5320		PH5135		PHS135 <small>NEW</small>						
N ALUMINIUM & NFM	PH0910										UNCOTED		
S HEAT RESISTENT / TITANIUM ALLOYS	PH7920			PHP920 <small>NEW</small>			PHP930 <small>NEW</small>						PVD
	PH7920			PHP920 <small>NEW</small>			PHP930 <small>NEW</small>						
	PH7920			PHP920 <small>NEW</small>			PHP930 <small>NEW</small>						

D

GROOVING & PARTING OFF

Grooving Plus

Grooving & Parting Off

SAL - Swiss Automatic Lathes

Light Grooving

Forming Grooving

Technical Data

GROOVING & PARTING OFF GRADES DESCRIPTION

Graus de Sangramento | Calidades para Tronzado

PVD GRADES

PH7920
 P10-P35
 M10-M25
 S10-S30

A hard carbide substrate coated with PVD coating. Suitable for machining under good conditions or lightly interrupted cuts.

PHP920 NEW
 P10-P35
 M10-M25
 S10-S30

A hard carbide insert coated with revolutionary PVD coating with great adhesion and smoothness. Recommended for machining under good conditions or lightly interrupted cuts at medium to high cutting speeds.

PHP930 NEW
 P20-P40
 M20-M40
 S15-S35

A tough carbide insert coated with revolutionary PVD coating with great adhesion and smoothness. Recommended for machining under lightly to highly interrupted cuts at low to medium cutting speeds.



CVD GRADES

PH5

A thick CVD coating with a smooth surface. Works great at medium temperatures.

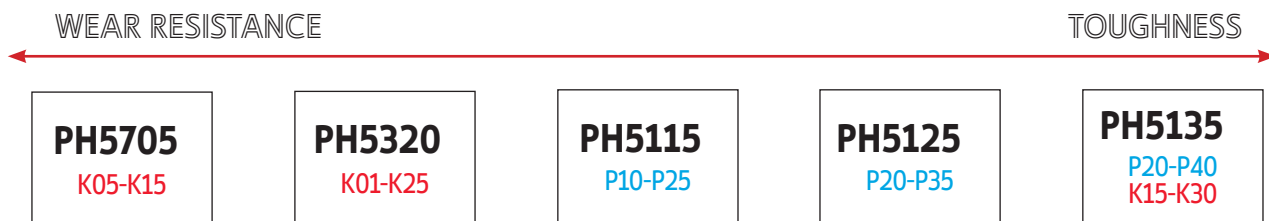

PHS

PHS135 NEW
 P20-P40
 M15-M35
 K15-K30

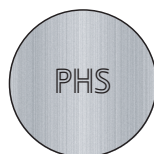

A tough substrate combined with a thin CVD coating with excellent thermal resistance and hardness at high temperature. Excellent solution for difficult operations at low velocities.

UNCOATED CARBIDE GRADE

PH0910
 N01-N20

Uncoated carbide with polished surface. 1st choice for machining aluminum alloys.

RECOMMENDED GRADES AND CUTTING SPEEDS (M/MIN)

Graus recomendados e velocidades de corte (m/min) | Calidades recomendadas y velocidades de corte (m/min)

ISO	Material	Grade fn (mm/r) HB (brinell)	CVD Coating				PVD Coating			
			← Wear Resistance →						Toughness →	
			PH5115	PH5125	PH5135	PHS135	PH7920	PHP920	PHP930	
P	Unalloyed steel	125-170	90-180	80-170	70-160	70-160	60-160	60-160	50-150	
	Low-alloy steel	180-350	70-160	60-150	60-140	60-150	60-140	60-150	50-140	
	High-alloy steel	200-325	50-150	40-140	40-130	40-140	50-130	50-140	40-130	

ISO	Material	Grade fn (mm/r) HB (brinell)	CVD Coating	PVD Coating					
			← Wear Resistance →						Toughness →
			PHS135	PH7920	PHP920	PHP930			
M	SS - Ferritic / Martensitic	200-330	70-150	60-140	60-140	50-130			
	SS - Austenitic / Duplex	180-330	60-130	60-120	60-130	50-110			
	SS - Ferritic / Duplex	230-260	40-120	40-110	40-120	40-110			

ISO	Material	Grade fn (mm/r) HB (brinell)	CVD Coating						
			← Wear Resistance →						Toughness →
			PH5705	PH5320	PH5115	PHS135			
K	Marble cast iron	130-230	100-220	90-210	90-200	80-170			
	Grey cast iron	180-220	100-200	90-190	80-180	70-150			
	Nodular cast iron	160-380	80-170	80-160	70-150	50-140			

ISO	Material	Grade fn (mm/r) HB (brinell)	Uncoated
			PH0910
			0.04 - 0.35
N	Aluminium alloys	60-130	190-1800

ISO	Material	Grade fn (mm/r) HB (brinell)	PVD Coating						
			← Wear Resistance →						Toughness →
			PH7920	PHP920	PHP930				
S	Heat resistant super alloys (Iron base)	200-280	35-90	-	-				
	Heat resistant super alloys (Nickel base)	250-320	22-60	-	-				
	Heat resistant super alloys (Cobalt base)	200-320	30-90	30-90	20-80				

D

GROOVING & PARTING OFF

Grooving Plus

Grooving & Parting Off

SAL - Swiss Automatic Lathes

Light Grooving

Forming Grooving

Technical Data



E - THREADING

E - 782 | THREAD MILLING

E - 782 | Inserts

E - 792 | Toolholders

E - 798 | Technical data





THREADING



E - 799 | THREAD TURNING

E - 802 | Inserts Overview

E - 804 | Partial Profile Inserts

E - 808 | Full Profile Inserts

E - 848 | Tangential Profile Inserts

E - 850 | External Toolholders

E - 854 | Internal Toolholders

E - 859 | Spare Parts

E - 860 | Technical Data

THREAD MILLING INSERTS CODE KEY

Codificação ISO para pastilhas de fresagem de roscar | Codificación ISO para plaquitas de fresado de roscar



1 - Insert Size	
	12
	14
	21
	30
	40

2 - Insert Hand Type	
E	External
I	Internal
I/E	Internal + External

3 - Pitch
Example : 20 = 20.00

4 - Profile Type					
symbol	profile type	symbol	profile type	symbol	profile type
ISO	ISO METRIC	NPT	NPT	ACME	AMERICAN ACME
UN	AMERICAN UN	NPTF	NPTF	PG	PG
W	WITHWORTH	NPS	NPS	UNJ	UNJ
BSPT	BSPT	NPSF	NPSF	ABUT	AMERICAN BUTTRESS

5 - Grades
PH7920



E - 782 | Inserts code key

E - 784 | Inserts program

E - 792 | Toolholders code key

E - 793 | Toolholders program

E - 798 | Technical data

THREAD MILLING

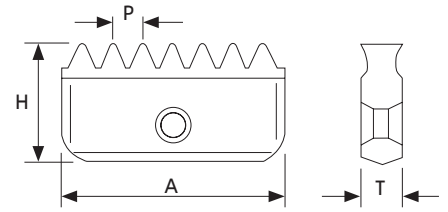
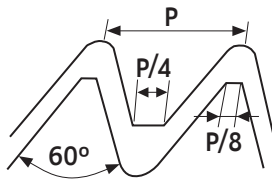

A	T	H
A 12	2,9	6,3
A 14	3,1	7,5
A 21	4,7	12
A 30	5,5	16
A 40	6,3	20

External

P (Pitch)	Dimensions Dimensões Dimensiones (mm)								Stock grade code ⁽²⁾
	A 14		A 21		A 30		A 40		
	Geometry code ⁽¹⁾	Ref.	Geometry code ⁽¹⁾	Ref.	Geometry code ⁽¹⁾	Ref.	Geometry code ⁽¹⁾	Ref.	(G4) PH7920
0.75 EXT	2123972	14 E 0.75 ISO							⊗
0.80 EXT	2124202	14 E 0.80 ISO							⊗
1.00 EXT	2123973	14 E 1.00 ISO	2123987	21 E 1.00 ISO					⊗
1.25 EXT	2123974	14 E 1.25 ISO							⊗
1.50 EXT	2123975	14 E 1.50 ISO	2123988	21 E 1.50 ISO	2123999	30 E 1.50 ISO	2124012	40 E 1.50 ISO	⊗
1.75 EXT	2123976	14 E 1.75 ISO							⊗
2.00 EXT	2123977	14 E 2.00 ISO	2123989	21 E 2.00 ISO	2124000	30 E 2.00 ISO	2124013	40 E 2.00 ISO	⊗
2.50 EXT	2123978	14 E 2.50 ISO	2123990	21 E 2.50 ISO					⊗
3.00 EXT			2123991	21 E 3.00 ISO	2124001	30 E 3.00 ISO	2124014	40 E 3.00 ISO	⊗
3.50 EXT					2124002	30 E 3.50 ISO			⊗
4.00 EXT					2124003	30 E 4.00 ISO	2124015	40 E 4.00 ISO	⊗
5.00 EXT							2124016	40 E 5.00 ISO	⊗
6.00 EXT							2124017	40 E 6.00 ISO	⊗

⊗ Stock item | Produto de stock | Itens de stock

Insert order code = (1) Geometry Code + (2) Grade Code

Internal

P (Pitch)	Dimensions Dimensões Dimensiones (mm)										Stock grade code ⁽²⁾
	A 12		A 14		A 21		A 30		A 40		
	Geometry code ⁽¹⁾	Ref.	Geometry code ⁽¹⁾	Ref.	Geometry code ⁽¹⁾	Ref.	Geometry code ⁽¹⁾	Ref.	Geometry code ⁽¹⁾	Ref.	(G4) PH7920
0.50 INT	2123967	12 0.50 ISO	2123979	14 0.50 ISO							⊗
0.75 INT	2123968	12 0.75 ISO	2123980	14 0.75 ISO							⊗
1.00 INT	2123969	12 1.00 ISO	2123981	14 1.00 ISO	2123992	21 1.00 ISO					⊗
1.25 INT	2123970	12 1.25 ISO	2123982	14 1.25 ISO							⊗
1.50 INT	2123971	12 1.50 ISO	2123983	14 1.50 ISO	2123993	21 1.50 ISO	2124004	30 1.50 ISO	2124018	40 1.50 ISO	⊗
1.75 INT			2123984	14 1.75 ISO	2123994	21 1.75 ISO					⊗
2.00 INT			2123985	14 2.00 ISO	2123995	21 2.00 ISO	2124005	30 2.00 ISO	2124019	40 2.00 ISO	⊗
2.50 INT			2123986	14 2.50 ISO	2123996	21 2.50 ISO					⊗
3.00 INT					2123997	21 3.00 ISO	2124006	30 3.00 ISO	2124020	40 3.00 ISO	⊗
3.50 INT					2123998	21 3.50 ISO	2124007	30 3.50 ISO	2124021	40 3.50 ISO	⊗
4.00 INT							2124008	30 4.00 ISO	2124022	40 4.00 ISO	⊗
4.50 INT							2124009	30 4.50 ISO	2124023	40 4.50 ISO	⊗
5.00 INT							2124010	30 5.00 ISO	2124024	40 5.00 ISO	⊗
5.50 INT							2124011	30 5.50 ISO	2124025	40 5.50 ISO	⊗
6.00 INT									2124026	40 6.00 ISO	⊗

⊗ Stock item | Produto de stock | Itens de stock

Insert order code = (1) Geometry Code + (2) Grade Code

UN UNC, UNF, UNEF, UNS Two cutting edges | Duas arestas de corte | Dos filos de corte

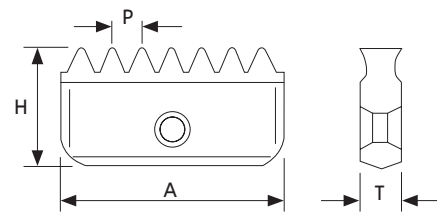
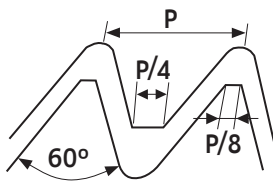

A	T	H
A 12	2,9	6,3
A 14	3,1	7,5
A 21	4,7	12
A 30	5,5	16
A 40	6,3	20

External

P (Pitch)	Dimensions Dimensões Dimensiones (mm)								Stock grade code ⁽²⁾
	A 14		A 21		A 30		A 40		
	Geometry code ⁽¹⁾	Ref.	Geometry code ⁽¹⁾	Ref.	Geometry code ⁽¹⁾	Ref.	Geometry code ⁽¹⁾	Ref.	(G4) PH7920
32.00 EXT	2124033	14 E 32 UN							☉
28.00 EXT	2124034	14 E 28 UN							☉
24.00 EXT	2124035	14 E 24 UN	2124055	21 E 24 UN					☉
20.00 EXT	2124036	14 E 20 UN	2124056	21 E 20 UN	2124072	30 E 20 UN			☉
18.00 EXT	2124037	14 E 18 UN	2124057	21 E 18 UN	2124073	30 E 18 UN			☉
16.00 EXT	2124038	14 E 16 UN	2124058	21 E 16 UN	2124074	30 E 16 UN	2124089	40 E 16 UN	☉
14.00 EXT	2124039	14 E 14 UN	2124059	21 E 14 UN	2124075	30 E 14 UN	2124090	40 E 14 UN	☉
13.00 EXT	2124203	14 E 13 UN							☉
12.00 EXT	2124040	14 E 12 UN	2124060	21 E 12 UN	2124076	30 E 12 UN	2124091	40 E 12 UN	☉
11.00 EXT	2124041	14 E 11 UN							☉
10.00 EXT	2124042	14 E 10 UN	2124062	21 E 10 UN	2124077	30 E 10 UN	2124092	40 E 10 UN	☉
8.00 EXT					2124078	30 E 8.0 UN	2124093	40 E 8.0 UN	☉
6.00 EXT					2124079	30 E 6.0 UN	2124094	40 E 6.0 UN	☉

☉ Stock item | Produto de stock | Itens de stock

Insert order code = (1) Geometry Code + (2) Grade Code

Internal

P (Pitch)	Dimensions Dimensões Dimensiones (mm)										Stock grade code ⁽²⁾
	A 12		A 14		A 21		A 30		A 40		
	Geometry code ⁽¹⁾	Ref.	Geometry code ⁽¹⁾	Ref.	Geometry code ⁽¹⁾	Ref.	Geometry code ⁽¹⁾	Ref.	Geometry code ⁽¹⁾	Ref.	(G4) PH7920
32.00 INT	2124027	12 32 UN	2124043	14 32 UN							☉
28.00 INT	2124028	12 28 UN	2124044	14 28 UN							☉
27.00 INT			2124045	14 27 UN							☉
24.00 INT	2124029	12 24 UN	2124046	14 24 UN	2124063	21 24 UN					☉
20.00 INT	2124030	12 20 UN	2124047	14 20 UN	2124064	21 20 UN	2124080	30 20 UN			☉
18.00 INT	2124031	12 18 UN	2124048	14 18 UN	2124065	21 18 UN	2124081	30 18 UN			☉
16.00 INT	2124032	12 16 UN	2124049	14 16 UN	2124066	21 16 UN	2124082	30 16 UN	2124095	40 16 UN	☉
14.00 INT			2124050	14 14 UN	2124067	21 14 UN	2124083	30 14 UN	2124096	40 14 UN	☉
12.00 INT			2124051	14 12 UN	2124068	21 12 UN	2124084	30 12 UN	2124097	40 12 UN	☉
11.00 INT			2124052	14 11 UN							☉
10.00 INT			2124053	14 10 UN	2124069	21 10 UN	2124085	30 10 UN	2124098	40 10 UN	☉
9.00 INT			2124054	14 9.0 UN							☉
8.00 INT					2124070	21 8.0 UN	2124086	30 8.0 UN	2124099	40 8.0 UN	☉
7.00 INT					2124071	21 7.0 UN					☉
6.00 INT							2124087	30 6.0 UN	2124100	40 6.0 UN	☉
5.00 INT							2124088	30 5.0 UN			☉
4.50 INT									2124101	40 4.5 UN	☉
4.00 EXT									2124102	40 4.0 UN	☉

☉ Stock item | Produto de stock | Itens de stock

Insert order code = (1) Geometry Code + (2) Grade Code

WHIT BSW, BSF, BSP Two cutting edges | Duas arestas de corte | Dos filos de corte

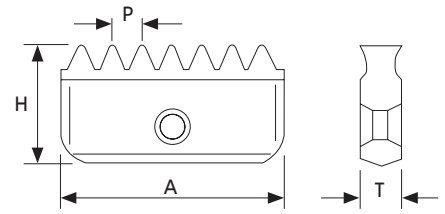
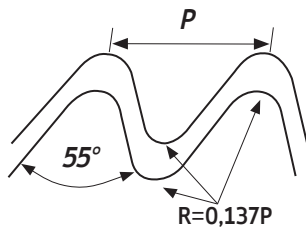
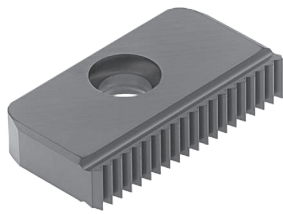

A	T	H
A 12	2,9	6,3
A 14	3,1	7,5
A 21	4,7	12
A 30	5,5	16
A 40	6,3	20

Same insert for external and internal thread | Mesma pastilha para rosca externa e interna | Misma plaquita para roscado externo e interno

P (Pitch)	Dimensions Dimensões Dimensiones (mm)										Stock grade code ⁽²⁾
	A 12		A 14		A 21		A 30		A 40		
	Geometry code ⁽¹⁾	Ref.	Geometry code ⁽¹⁾	Ref.	Geometry code ⁽¹⁾	Ref.	Geometry code ⁽¹⁾	Ref.	Geometry code ⁽¹⁾	Ref.	
24.00			2124104	14 I/E 24 W							⊗
20.00			2124105	14 I/E 20 W	2124110	21 I/E 20 W					⊗
19.00	2124103	12 I/E 19 W*	2124106	14 I/E 19 W	2124111	21 I/E 19 W					⊗
16.00			2124107	14 I/E 16 W	2124112	21 I/E 16 W	2124115	30 I/E 16 W			⊗
14.00			2124108	14 I/E 14 W	2124113	21 I/E 14 W	2124116	30 I/E 14 W			⊗
11.00			2124109	14 I/E 11 W	2124114	21 I/E 11 W	2124117	30 I/E 11 W	2124118	40 I/E 11 W	⊗
8.00									2124119	40 I/E 8 W	⊗

*One cutting edge | Uma aresta de corte | Un filo de corte

⊗ Stock item | Produto de stock | Itens de stock

Insert order code = (1) Geometry Code + (2) Grade Code

BSPT One cutting edge | Uma aresta de corte | Un filo de corte

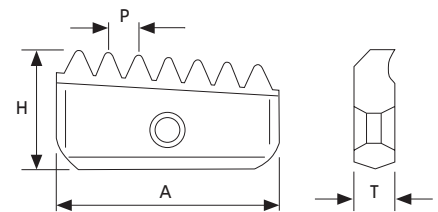
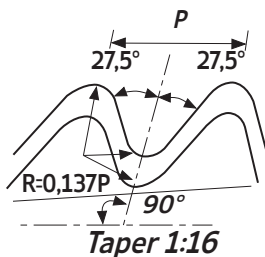

A	T	H
A 12	2,9	6,3
A 14	3,1	7,5
A 21	4,7	12
A 30	5,5	16
A 40	6,3	20

Conical pipe thread milling inserts are one sided and may be used for both external and internal threading | As pastilhas de rosca para tubos cônicos têm uma face e podem ser usadas para rosca externa e interna | Las plaquitas de roscado para tubos cônicos tienen una cara y pueden ser usadas para roscado externo e interno.

P (Pitch)	Dimensions Dimensões Dimensiones (mm)										Stock grade code ⁽²⁾
	A 12		A 14		A 21		A 30		A 40		
	Geometry code ⁽¹⁾	Ref.	Geometry code ⁽¹⁾	Ref.	Geometry code ⁽¹⁾	Ref.	Geometry code ⁽¹⁾	Ref.	Geometry code ⁽¹⁾	Ref.	
19.00	2124120	12 I/E 19 BSPT	2124121	14 I/E 19 BSPT							⊗
14.00			2124122	14 I/E 14 BSPT	2124123	21 I/E 14 BSPT					⊗
11.00					2124124	21 I/E 11 BSPT	2124125	30 I/E 11 BSPT	2124126	40 I/E 11 BSPT	⊗

⊗ Stock item | Produto de stock | Itens de stock

Insert order code = (1) Geometry Code + (2) Grade Code

NPT One cutting edge | Uma aresta de corte | Un filo de corte

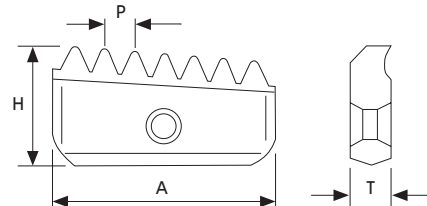
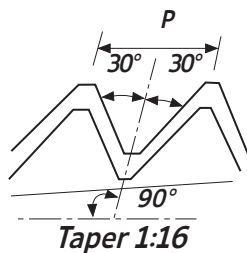

A	T	H
A 12	2,9	6,3
A 14	3,1	7,5
A 21	4,7	12
A 30	5,5	16
A 40	6,3	20

Conical pipe thread milling inserts are one sided and may be used for both external and internal threading | As pastilhas de roscagem para tubos cônicos têm uma face e podem ser usadas para roscagem externa e interna | Las plaquitas de roscado para tubos cônicos tienen una cara y pueden ser usadas para roscado externo e interno.

P (Pitch)	Dimensions Dimensões Dimensiones (mm)										Stock grade code (2)
	A 12		A 14		A 21		A 30		A 40		
	Geometry code (1)	Ref.	Geometry code (1)	Ref.	Geometry code (1)	Ref.	Geometry code (1)	Ref.	Geometry code (1)	Ref.	
18.00	2124127	12 I/E 18 NPT	2124128	14 I/E 18 NPT							⊗
14.00			2124129	14 I/E 14 NPT	2124130	21 I/E 14 NPT					⊗
11.50					2124131	21 I/E 11.5 NPT	2124132	30 I/E 11.5 NPT	2124134	40 I/E 11.5 NPT	⊗
8.00							2124133	30 I/E 8 NPT	2124135	40 I/E 8 NPT	⊗

⊗ Stock item | Produto de stock | Itens de stock

Insert order code = (1) Geometry Code + (2) Grade Code

NPTF One cutting edge | Uma aresta de corte | Un filo de corte

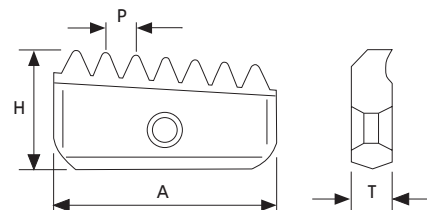
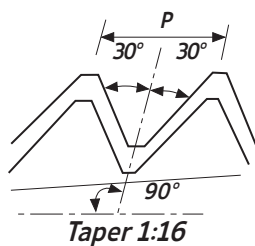

A	T	H
A 12	2,9	6,3
A 14	3,1	7,5
A 21	4,7	12
A 30	5,5	16
A 40	6,3	20

Conical pipe thread milling inserts are one sided and may be used for both external and internal threading | As pastilhas de roscagem para tubos cônicos têm uma face e podem ser usadas para roscagem externa e interna | Las plaquitas de roscado para tubos cônicos tienen una cara y pueden ser usadas para roscado externo e interno.

P (Pitch)	Dimensions Dimensões Dimensiones (mm)										Stock grade code (2)
	A 12		A 14		A 21		A 30		A 40		
	Geometry code (1)	Ref.	Geometry code (1)	Ref.	Geometry code (1)	Ref.	Geometry code (1)	Ref.	Geometry code (1)	Ref.	
18.00	2124136	12 I/E 18 NPTF	2124137	14 I/E 18 NPTF							⊗
14.00			2124138	14 I/E 14 NPTF	2124139	21 I/E 14 NPTF					⊗
11.50					2124140	21 I/E 11.5 NPTF	2124141	30 I/E 11.5 NPTF	2124143	40 I/E 11.5 NPTF	⊗
8.00							2124142	30 I/E 8 NPTF	2124144	40 I/E 8 NPTF	⊗

⊗ Stock item | Produto de stock | Itens de stock

Insert order code = (1) Geometry Code + (2) Grade Code

THREADING
Thread milling - Inserts
Thread milling - Toolholders
Thread turning - Overview
Thread turning - Inserts
Thread turning - Toolholders
Thread turning - Spare Parts
Technical Data

NPS Two cutting edges | Duas arestas de corte | Dos filos de corte

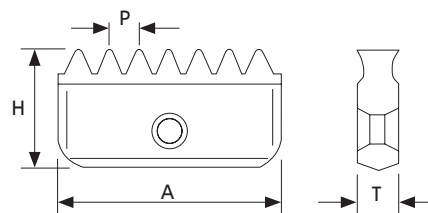
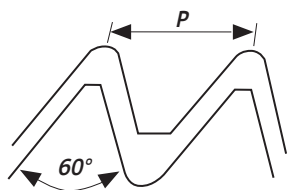

A	T	H
A 12	2,9	6,3
A 14	3,1	7,5
A 21	4,7	12
A 30	5,5	16
A 40	6,3	20

Same insert for external and internal thread | Mesma pastilha para roscagem externa e interna | Misma plaqueta para roscado externo e interno

P (Pitch)	Dimensions Dimensões Dimensiones (mm)										Stock grade code ⁽²⁾
	A 12		A 14		A 21		A 30		A 40		
	Geometry code ⁽¹⁾	Ref.	Geometry code ⁽¹⁾	Ref.	Geometry code ⁽¹⁾	Ref.	Geometry code ⁽¹⁾	Ref.	Geometry code ⁽¹⁾	Ref.	
18.00	2124145	12 I/E 18 NPS*	2124147	14 I/E 18 NPS							⊗
14.00			2124148	14 I/E 14 NPS	2124149	21 I/E 14 NPS					⊗
11.50					2124150	21 I/E 11.5 NPS	2124151	30 I/E 11.5 NPS	2124153	40 I/E 11.5 NPS	⊗
8.00							2124152	30 I/E 8 NPS	2124154	40 I/E 8 NPS	⊗

*One cutting edge | Uma aresta de corte | Un filo de corte

⊗ Stock item | Produto de stock | Itens de stock

Insert order code = (1) Geometry Code + (2) Grade Code

NPSF Two cutting edges | Duas arestas de corte | Dos filos de corte

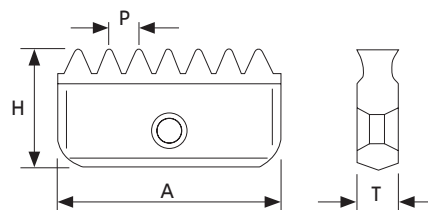
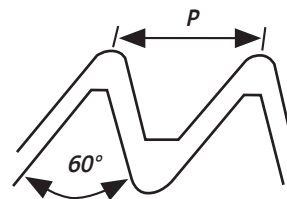

A	T	H
A 12	2,9	6,3
A 14	3,1	7,5
A 21	4,7	12
A 30	5,5	16
A 40	6,3	20

Same insert for external and internal thread | Mesma pastilha para roscagem externa e interna | Misma plaqueta para roscado externo e interno

P (Pitch)	Dimensions Dimensões Dimensiones (mm)										Stock grade code ⁽²⁾
	A 12		A 14		A 21		A 30		A 40		
	Geometry code ⁽¹⁾	Ref.	Geometry code ⁽¹⁾	Ref.	Geometry code ⁽¹⁾	Ref.	Geometry code ⁽¹⁾	Ref.	Geometry code ⁽¹⁾	Ref.	
18.00	2124155	12 I/E 18 NPSF*	2124156	14 I/E 18 NPSF							⊗
14.00			2124157	14 I/E 14 NPSF	2124158	21 I/E 14 NPSF					⊗
11.50					2124159	21 I/E 11.5 NPSF	2124160	30 I/E 11.5 NPSF	2124162	40 I/E 11.5 NPSF	⊗
8.00							2124161	30 I/E 8 NPSF	2124163	40 I/E 8 NPSF	⊗

*One cutting edge | Uma aresta de corte | Un filo de corte

⊗ Stock item | Produto de stock | Itens de stock

Insert order code = (1) Geometry Code + (2) Grade Code

PG DIN 40430 Two cutting edges | Duas arestas de corte | Dos filos de corte

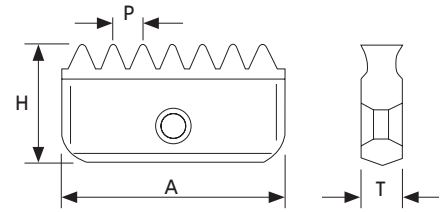
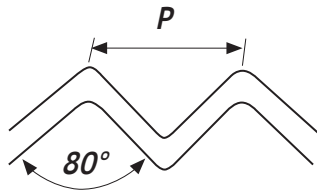

A	T	H
A 14	3,1	7,5
A 21	4,7	12
A 30	5,5	16

Same insert for external and internal thread | Mesma pastilha para rosca externa e interna | Misma plaquita para roscado externo e interno

P (Pitch)	Dimensions Dimensões Dimensiones (mm)						Stock grade code ⁽²⁾
	A 14		A 21		A 30		
	Geometry code ⁽¹⁾	Ref.	Geometry code ⁽¹⁾	Ref.	Geometry code ⁽¹⁾	Ref.	(G4) PH7920
18.00	2124164	14 I/E 18 PG	2124165	21 I/E 18 PG			⊗
16.00			2124166	21 I/E 16 PG	2124167	30 I/E 16 PG	⊗

*One cutting edge | Uma aresta de corte | Un filo de corte

⊗ Stock item | Produto de stock | Itens de stock

Insert order code = (1) Geometry Code + (2) Grade Code

UNJ Two cutting edges | Duas arestas de corte | Dos filos de corte

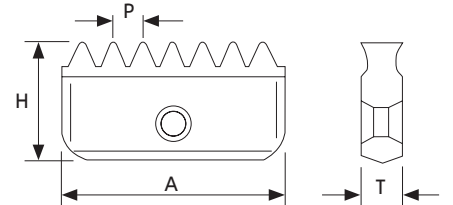
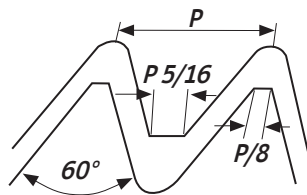

A	T	H
A 14	3,1	7,5
A 21	4,7	12

Same insert for external and internal thread | Mesma pastilha para rosca externa e interna | Misma plaquita para roscado externo e interno

P (Pitch)	Dimensions Dimensões Dimensiones (mm)				Stock grade code ⁽²⁾
	A 14		A 21		
	Geometry code ⁽¹⁾	Ref.	Geometry code ⁽¹⁾	Ref.	(G4) PH7920
24.00	2124168	14 E 24 UNJ	2124174	21 E 24 UNJ	⊗
20.00	2124169	14 E 20 UNJ	2124175	21 E 20 UNJ	⊗
18.00	2124170	14 E 18 UNJ	2124176	21 E 18 UNJ	⊗
16.00	2124171	14 E 16 UNJ	2124177	21 E 16 UNJ	⊗
14.00	2124172	14 E 14 UNJ			⊗
12.00	2124173	14 E 12 UNJ	2124179	21 E 12 UNJ	⊗

⊗ Stock item | Produto de stock | Itens de stock

Insert order code = (1) Geometry Code + (2) Grade Code

Note: For internal UNJ threads it is common to use UN inserts as partial profile tool | Para rosca interna UNJ é comum utilizar pastilhas UN como ferramenta de perfil parcial | Para roscado interno UNJ é usual utilizar plaquitas UN como herramienta de perfilado parcial

AMERICAN BUTTRESS Two cutting edges | Duas arestas de corte | Dos filos de corte

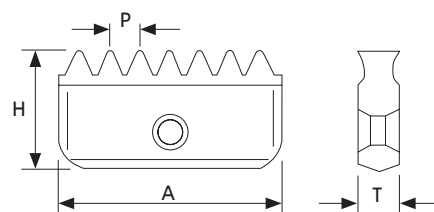
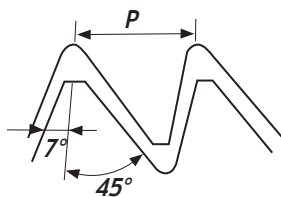

A	T	H
21	4,7	12
30	5,5	16

Same insert for external and internal thread | Mesma pastilha para roscagem externa e interna | Misma plaquita para roscado externo e interno

P (Pitch)	Dimensions Dimensões Dimensiones (mm)				Stock grade code ⁽²⁾
	A 21		A 30		
	Geometry code ⁽¹⁾	Ref.	Geometry code ⁽¹⁾	Ref.	(G4) PH7920
16.00	2124180	21 I/E 16 ABUT	2124184	30 I/E 16 ABUT	⊗
12.00	2124181	21 I/E 12 ABUT	2124185	30 I/E 12 ABUT	⊗
10.00	2124182	21 I/E 10 ABUT	2124186	30 I/E 10 ABUT	⊗
8.00	2124183	21 I/E 8 ABUT	2124187	30 I/E 8 ABUT	⊗
6.00			2124188	30 I/E 6 ABUT	⊗
4.00			2124189	30 I/E 4 ABUT	⊗

⊗ Stock item | Produto de stock | Itens de stock

Insert order code = (1) Geometry Code + (2) Grade Code

Note: ABUT thread milling inserts are one-sided and it can be used only on Multi-insert toolholders | As pastilhas de roscagem ABUT são de uma face e só podem ser utilizadas nos suportes de múltiplas pastilhas | Las plaquitas de roscado ABUT son de una cara y sólo se pueden utilizar en las herramientas de múltiples plaquitas

ACME Two cutting edges | Duas arestas de corte | Dos filos de corte

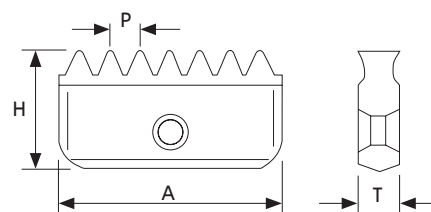
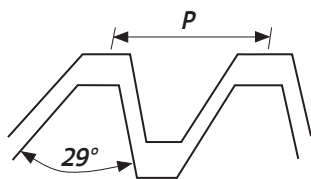

A	T	H
21	4,7	12
30	5,5	16
40	6,3	20

Same insert for external and internal thread | Mesma pastilha para roscagem externa e interna | Misma plaqueta para roscado externo e interno

P (Pitch)	Dimensions Dimensões Dimensiones (mm)						Stock grade code ⁽²⁾
	A 21		A 30		A 40		
	Geometry code ⁽¹⁾	Ref.	Geometry code ⁽¹⁾	Ref.	Geometry code ⁽¹⁾	Ref.	(G4) PH7920
12.00	2124191	21 12 ACME	2124194	30 12 ACME			⊗
10.00	2124192	21 10 ACME	2124195	30 10 ACME			⊗
8.00	2124193	21 8.0 ACME	2124196	30 8.0 ACME			⊗
6.00			2124197	30 6.0 ACME			⊗
4.00			2124198	30 4.0 ACME*	2124199	40 4.0 ACME	⊗
3.50					2124200	40 3.5 ACME	⊗
3.00					2124201	40 3.0 ACME* **	⊗

*One cutting edge | Uma aresta de corte | Un filo de corte

⊗ Stock item | Produto de stock | Itens de stock

Insert order code = (1) Geometry Code + (2) Grade Code

** Inserts to be used only on Multi-insert toolholders | Pastilhas que só podem ser utilizadas nos suportes de múltiplas pastilhas | Plaquetas que sólo se pueden utilizar en las herramientas de múltiples plaquetas

mm

THREADING

Thread milling - Inserts

Thread milling - Toolholders

Thread turning - Overview

Thread turning - Inserts

Thread turning - Toolholders

Thread turning - Spare Parts

Technical Data

THREAD MILLING TOOLHOLDERS CODE KEY

Codificação ISO para suportes de fresagem de roscar | Codificación ISO para herramientas de fresado de roscar

A	S	S	N	063	050	A21	-	5
1	2	3	4	5	6	7		8

1 - Mounting type

A	Arbor
E	Cylindrical
W	Weldon

2 - Toolholder material

S	Steel
C	Carbide

3 - Clamping

S	Screw
----------	-------

4 - Operation type

N	Internal+External
E	External

5 - Cutting diameter ($\varnothing D_c$ - mm)

Example : 063 = 63 mm

6 - Toolholder length (L - mm)

Example : 050 = 50 mm

7 - Insert Pocket Size

A12	12 mm
A14	14 mm
A21	21 mm
A30	30 mm
A40	40 mm

8 - Number of inserts

1	2	3	4	5
----------	----------	----------	----------	----------

MULTI INSERT TOOLHOLDERS

Suportes de múltiplas pastilhas | Herramientas de múltiples plaquitas

INTERNAL TOOLHOLDERS | Suportes internos | Herramientas internas

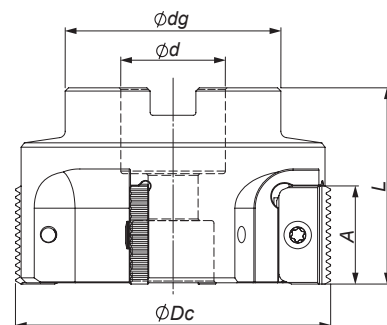

Order Code Código	Reference Referência Referencia	Dimensions Dimensões Dimensiones (mm)					Number of inserts	Insert screw	Stock
		A	ϕDc	ϕd	ϕdg	L			
212393200	ASSN 063 050 A21-5	21	63	22	40	50	5	P0401105	☉
212393300	ASSN 063 050 A30-4	30	63	22	55	50	4	P0501500	☉
212393400	ASSN 080 055 A30-4	30	80	27	58	55	4	P0501500	☉
212393600	ASSN 100 060 A30-4	30	100	32	66	60	4	P0501500	☉
212393500	ASSN 080 065 A40-4	40	80	27	58	65	4	P0502201	○
212393800	ASSN 100 070 A40-4	40	100	32	66	70	4	P0502201	○

☉ Stock item | Produto de stock | Itens de stock

○ Available under request | Disponível sobre consulta | Disponible bajo consulta

EXTERNAL TOOLHOLDERS | Suportes externos | Herramientas externas

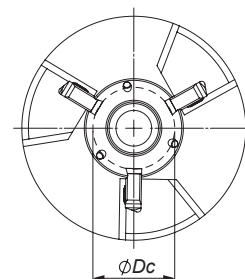
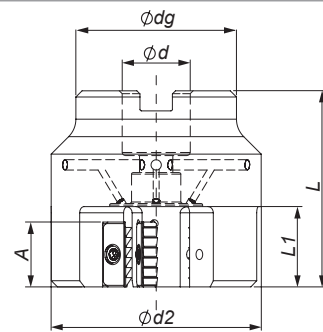
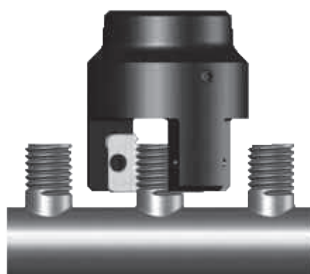

Order Code Código	Reference Referência Referencia	Dimensions Dimensões Dimensiones (mm)							Number of inserts	Insert screw	Stock
		A	ϕDc	ϕd	$\phi d2$	ϕdg	L	L1			
212396400	ASSE 020 065 A21-3	21	20	22	58	57	65	25	3	P0401105	○
212396500	ASSE 030 065 A21-3	21	30	22	68	52	65	25	3	P0401105	○
212396600	ASSE 045 070 A21-4	21	45	27	83	58	70	25	4	P0401105	○

☉ Stock item | Produto de stock | Itens de stock

○ Available under request | Disponível sobre consulta | Disponible bajo consulta

SINGLE INSERT TOOLHOLDERS

WSSN-1

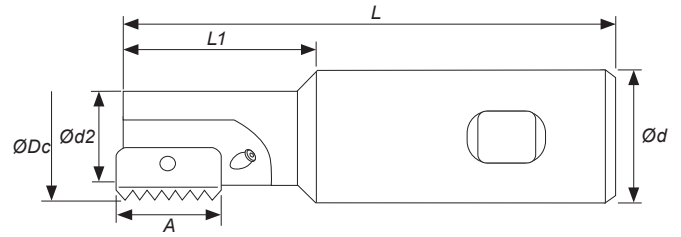

Order Code Código	Reference Referência Referencia	Dimensions Dimensões Dimensiones (mm)						Number of inserts	Insert screw	Stock
		A	ØDc	Ød	Ød2	L	L1			
212394700	WSSN 009 085 A12-1	12	9,5	20	7,5	85	14	1	P0260601	⊗
212394800	WSSN 010 085 A12-1	12	9,9	20	7,6	85	16	1	P0260601	⊗
212394900	WSSN 012 075 A14-1	14	12,0	20	8,9	75	20	1	P0260701	⊗
212395000	WSSN 014 085 A14-1	14	14,5	20	11,2	85	25	1	P0260701	⊗
212395100	WSSN 017 085 A14-1	14	17,0	20	13,4	85	30	1	P0260701	⊗
212395200	WSSN 018 085 A21-1*	21	18,0	20	14,4	85	30	1	P0401105	⊗
212395300	WSSN 021 094 A21-1	21	21,0	20	16,5	94	40	1	P0401105	⊗
212395400	WSSN 029 110 A30-1	30	29,0	25	22,4	110	50	1	P0501500	⊗
212395500	WSSN 048 153 A40-1	40	48,0	40	35,0	153	78	1	P0502201	○

⊗ Stock item | Produto de stock | Itens de stock ○ Available under request | Disponível sobre consulta | Disponible bajo consulta

*Can not be used with the following inserts: | Não pode ser usado com as seguintes pastilhas: | No se puede utilizar con las siguientes plaquitas:
21 I 3.5 ISO; 21 I 8.0 UN; 21 I 7.0 UN; 21 I/E 11 BSPT; 21 I/E 11.5 NPT; 21 I/E 11.5 NPTF

WSSN-1 || Long shank

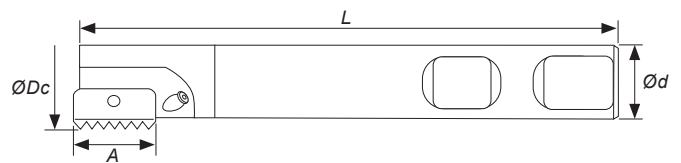

Order Code Código	Reference Referência Referencia	Dimensions Dimensões Dimensiones (mm)				Number of inserts	Insert screw	Stock
		A	ØDc	Ød	L			
212396000	WSSN 025 125 A21-1	21	25	20	125	1	P0401105	⊗
212396100	WSSN 031 150 A30-1	30	31	25	150	1	P0501500	⊗
212396200	WSSN 038 150 A30-1	30	38	32	150	1	P0501500	⊗
212396300	WSSN 048 210 A40-1	40	48	40	210	1	P0502201	○

⊗ Stock item | Produto de stock | Itens de stock ○ Available under request | Disponível sobre consulta | Disponible bajo consulta

Note: For holders with long overhang reduce the cutting speed by 20-40%, depending on workpiece, material, pitch and overhang | Para suportes com comprimento elevado reduza a velocidade de corte em 20-40%, dependendo da peça a maquinar, do material, do pitch e comprimento | Para herramientas con longitud elevada reduzca la velocidad de corte en 20-40%, dependiendo de la pieza a mecanizar, del material, del pitch y la longitud.

ECSN-1 || Long carbide shank

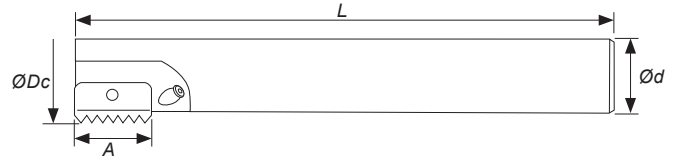

Order Code Código	Reference Referência Referencia	Dimensions Dimensões Dimensiones (mm)				Number of inserts	Insert screw	Stock
		A	ØDc	Ød	L			
212394000	ECSN 010 125 A12-1*	12	9,9	8	125	1	P0260601	⊗
212394100	ECSN 013 110 A14-1	14	13,2	10	110	1	P0260701	⊗
212394200	ECSN 013 155 A14-1	14	13,2	10	155	1	P0260701	⊗
212394300	ECSN 015 175 A14-1	14	15,2	12	175	1	P0260701	⊗
212394400	ECSN 021 130 A21-1	21	21,0	16	130	1	P0401105	⊗
212394500	ECSN 021 200 A21-1	21	21,0	16	200	1	P0401105	⊗
212394600	ECSN 027 270 A30-1	30	27,0	20	270	1	P0501500	○

⊗ Stock item | Produto de stock | Itens de stock

○ Available under request | Disponível sobre consulta | Disponible bajo consulta

* Without coolant bore | Sem furo de refrigeração | Sin agujero de refrigeración

Note: For holders with long overhang reduce the cutting speed by 20-40%, depending on workpiece, material, pitch and overhang | Para suportes com comprimento elevado reduza a velocidade de corte em 20-40%, dependendo da peça a maquinar, do material, do pitch e comprimento | Para herramientas con longitud elevada reduzca la velocidad de corte en 20-40%, dependiendo de la pieza a mecanizar, del material, del pitch y la longitud.

DOUBLE INSERT TOOLHOLDERS

Suportes de duas pastilhas | Herramientas de dos plaquitas

WSSN-2

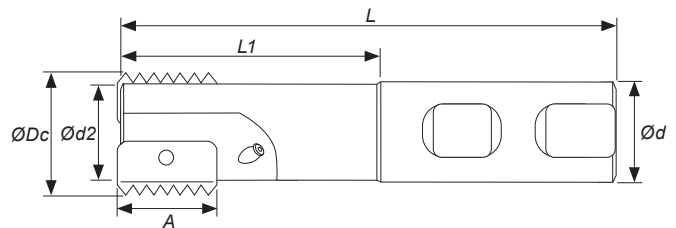

Order Code Código	Reference Referência Referencia	Dimensions Dimensões Dimensiones (mm)						Number of inserts	Insert screw	Stock
		A	ØDc	Ød	Ød2	L	L1			
212395600	WSSN 020 093 A14-2	14	20	20	16	93	41	2	P0260701	⊗
212395700	WSSN 030 108 A21-2	21	30	25	24	108	52	2	P0401105	⊗
212395800	WSSN 040 130 A30-2	30	40	32	30	130	70	2	P0501500	⊗
212395900	WSSN 050 153 A40-2	40	50	40	38	153	78	2	P0502201	○

⊗ Stock item | Produto de stock | Itens de stock

○ Available under request | Disponível sobre consulta | Disponible bajo consulta

THREAD MILLING TOOLHOLDERS TECHNICAL DATA

Conversion of selected cutting speed to rotational speed is calculated using the following formulas:

Spindle Speed (rev/min)

$$n = \frac{v_c \cdot 1000}{\pi \cdot D_c} \quad (\text{RPM})$$

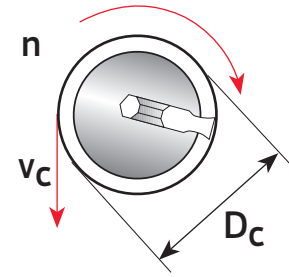

Cutting Speed (m/min)

$$v_c = \frac{n \cdot \pi \cdot D_c}{1000} \quad (\text{m/min})$$

Nomenclature

D_c	- Cutter diameter	(mm)
n	- Spindle Speed	(rev/min)
V_c	- Cutting Speed	(m/min)

Example for the following values:

$$V_c = 120 \text{ m/min}$$

$$D_c = 30 \text{ mm}$$

$$n = \frac{V_c \times 1000}{\pi \times D} = \frac{120 \times 1000}{3.14 \times 30} = 1274 \text{ RPM}$$

SPEED AND FEED SELECTION

Seleção da velocidade e do avanço | Selección de la velocidad e de avance

TiAlN – Sub-Micron Grade with Titanium Aluminium Nitride multi-layer coating (ISO K10-K20). This is a general purpose grade, which can be used with all materials, it should be run at medium to high cutting speeds.

Recommended Feed Rate: 0.05 - 0.15 mm

ISO	Material	Cutting Speed V_c (m/min) TiAlN
P	Low and Medium Carbon Steels	115 - 280
	High Carbon Steels	130 - 200
	Treated Steels	105 - 180
M	Stainless Steels, Cast Stainless Steels	130 - 190
	Cast Steels	150 - 190
K	Cast Iron	80 - 170
N	Non-Ferrous and Aluminium	180 - 340
	Synthetics, Duroplastics, Thermoplastics	115 - 460
S	Nickel Alloys, Titanium Alloys	25 - 90

INTERNAL THREAD | Roscagem interna | Roscado interno

Left hand thread | Rosca esquerda | Rosca izquierda

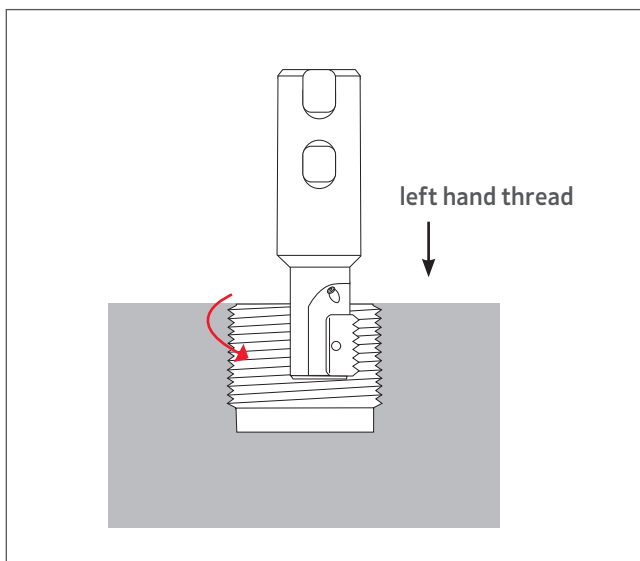

Right hand thread | Rosca direita | Rosca derecha

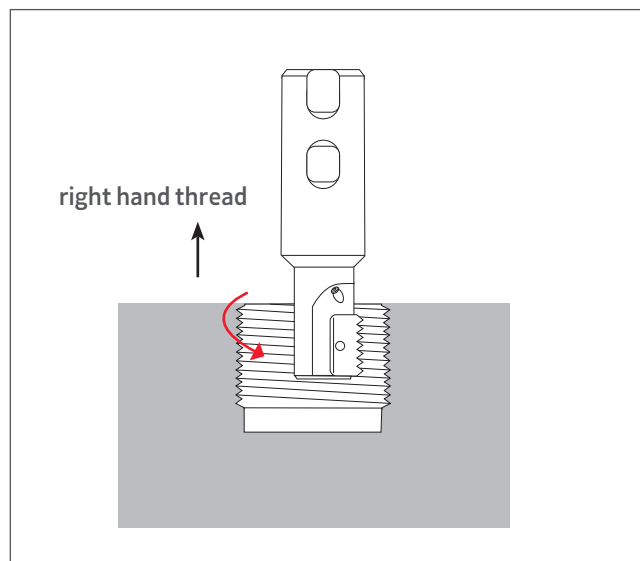

EXTERNAL THREAD | Roscagem externa | Roscado externo

Left hand thread | Rosca esquerda | Rosca izquierda

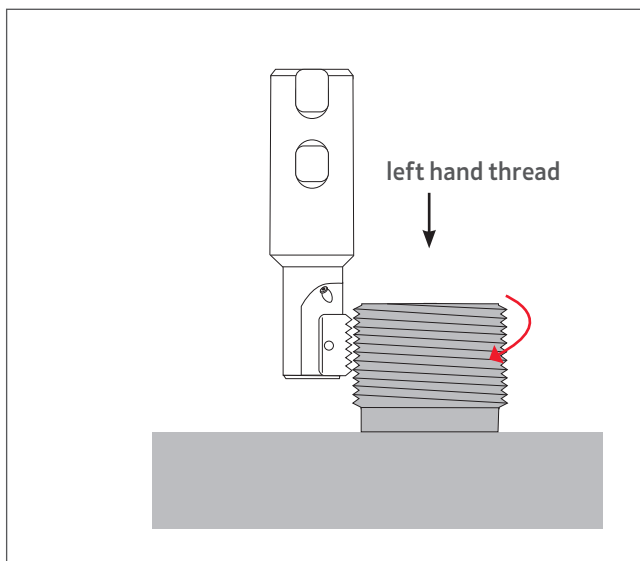

Right hand thread | Rosca direita | Rosca derecha

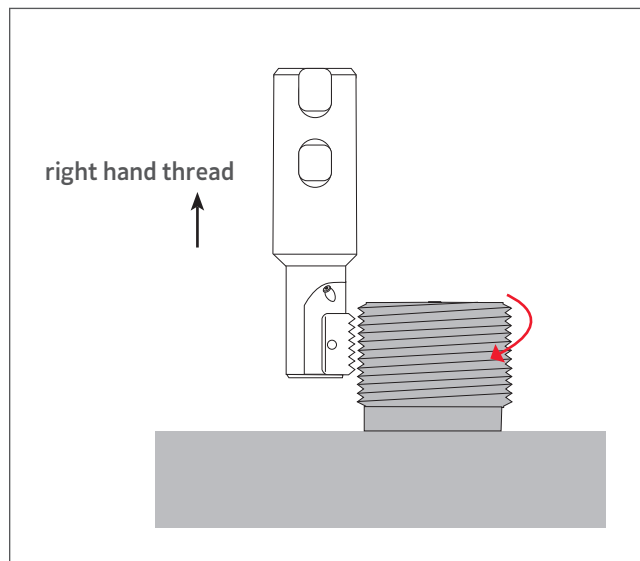

TOOL SELECTION | Selecção de ferramenta | Selección de herramienta

The chart below provide a accurate visual selection tool for internal threading.
(Suitable for the thread forms: ISO, UN, WHIT, NPT, NPTF, BSPT and PG)

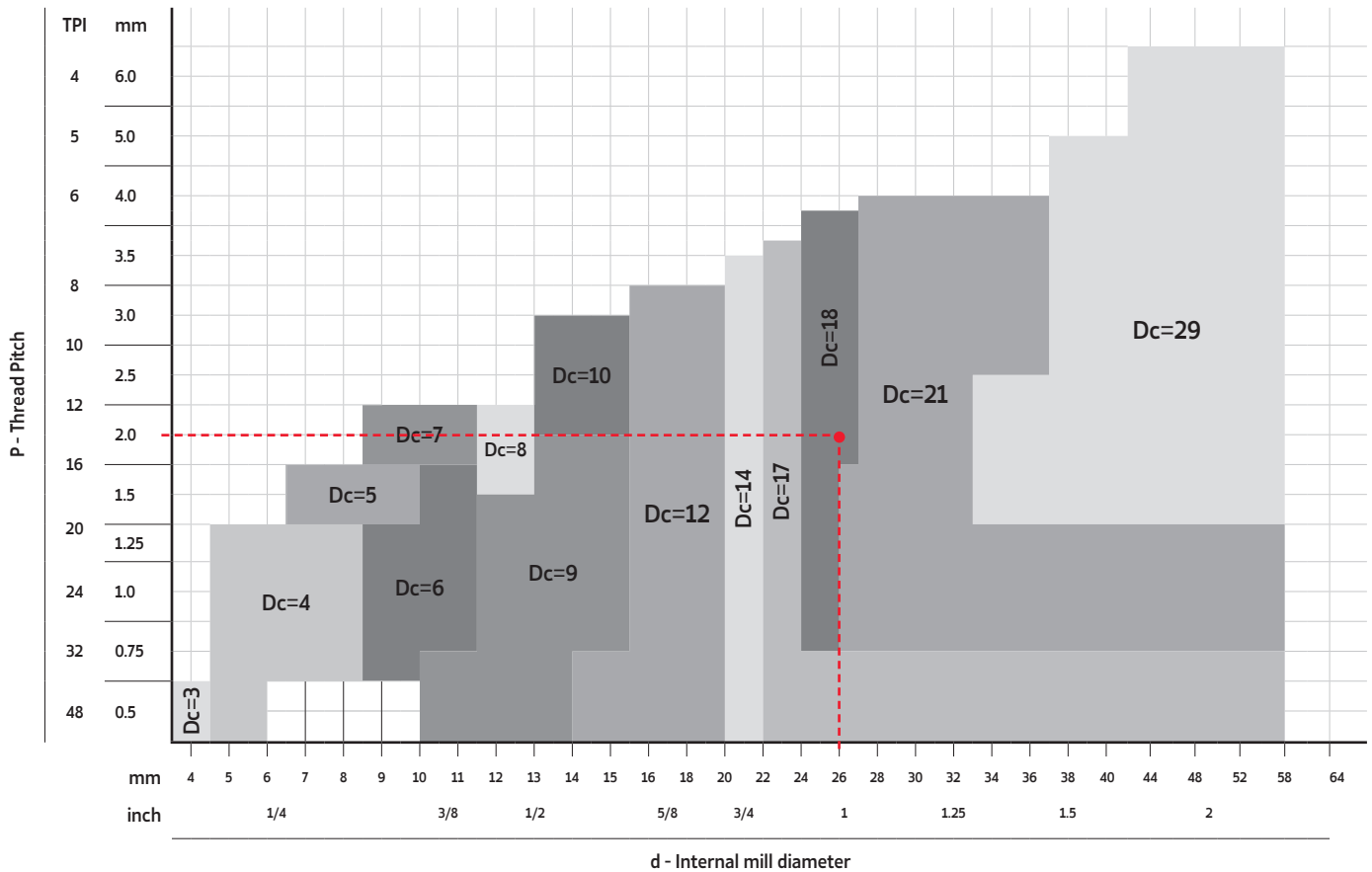

Any tool with a small diameter can produce larger diameter threads.

Example:

Internal thread: M26 x 2.0

Find a milling tool to produce **d = 26 internal** right hand ISO thread with a tread pitch **P = 2.0mm**.

Internal mill diameter **d = 26 mm**

+

Thread pitch **P = 2.0 mm**

As you can see above, the two red lines intersect at a selected tool with a cutting diameter of **Dc = 18 mm**

Chosen toolholder - order code: 212395200 | Reference: WSSN 018 085 A21-1

Chosen insert - order code: 2123995G4 | Reference: 21 | 2.0 ISO PH7920

Right hand Thread
Rosca direita | Rosca derecha

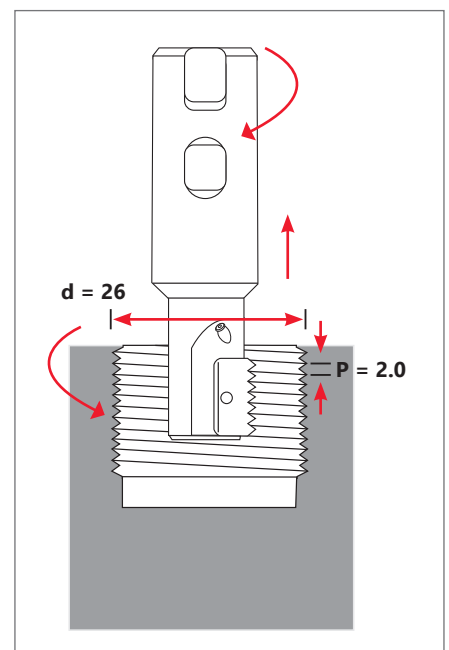



- E - 802 | Inserts Overview
- E - 805 | Inserts program
- E - 850 | External Toolholders
- E - 854 | Internal Toolholders
- E - 859 | Spare Parts
- E - 860 | Technical Data

THREAD TURNING

THREAD TURNING - STEP BY STEP EXAMPLE

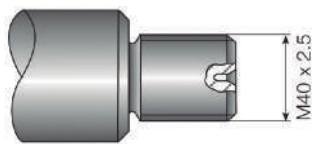

Application:

Thread: External Right Hand
ISO Metric M40x2,5

Material: 4140 (25HRC)

1 - Choose the Thread Working Method

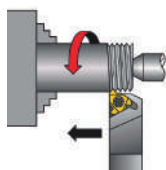

Feed direction towards the chuck was chosen.

Therefore, an external right hand insert and an external right hand holder will be used.

2 - Choose the Insert Size

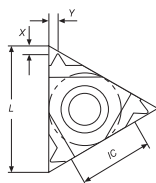

Chosen insert: **16ER 2.50ISO**

Insert Size	Pitch	Reference	Anvil	Toolholder
IC L mm	mm		RH	
9.525 16	2.50	16ER 2.50ISO	EA16	STCNL 2525 M16

3 - Choose the Toolholder

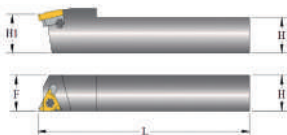

Chosen toolholder: **SXANR 2525 M16**

Insert Size	Reference	Dimensions mm		
IC		H=H1=B	F	L
9.525	SXANR 2525 M16	25	25	150

4 - Find the Helix Angle

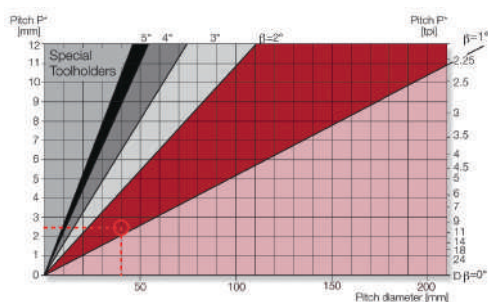

From the table, using a pitch of 2,5mm (10 tpi) and a workpiece diameter of 40mm (1,57"), we find the helix angle to be **1,5°**

5 - Choose the Correct Anvil

Anvil chosen: **EA16**

Resultant Helix Angle		3.5	2.5	1.5	0.5	
Insert Size		Holder				
IC	L mm	ER/IL	EA16+3.5	EA16+2.5	EA16	EA16+0.5
9,525	16					

6 - Choose the Carbide Grade and Cutting Speed

Carbide grade chosen: **PH6920**
Cutting Speed: **140 m/min**

Material:		Hardness Brinell HB		PH6920
P	Low alloy steel (alloying elements ≤ 5%)	Non hardened	180	85-145
		Hardened	275	75-140
		Hardened	350	70-135

7 - Determine the Number of Passes

Number of passes; 10



ISO External

Pitch	mm	1.50	1.75	2.00	2.50	3.00	3.50	4.00
	tpi	16	14	12	10	8	7	6
No. of passes		6-10	7-12	7-12	8-14	9-16	10-18	11-18

Summary

	Thread Type	ISO M40x2,5 External Right Hand
1	Feed Direction:	Towards the chuck
2	Insert and Grade:	16ER 2,5ISO PH6920
3	Toolholder:	SXANR 2525 M16
4	Helix Angle:	1,5°
5	Anvil:	EA16
6	Cutting Speed:	140 m/min
7	Number of Passes;	14

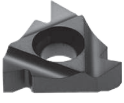
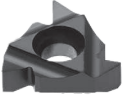
THREAD TURNING INSERTS OVERVIEW

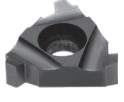
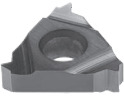
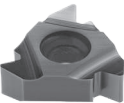
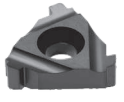
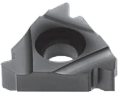
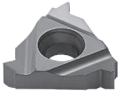
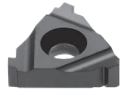
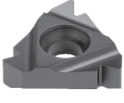
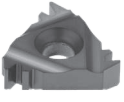
	Insert Image	Description	Page
Partial Profile		PARTIAL PROFILE 60°	721
		PARTIAL PROFILE 55°	722
Full Profile		AMERICAN BUTTRESS ANSI B1.9-1973	757
		AMERICAN ACME ANSI/ASME: 1.5-1988	748
		AMERICAN UN (UNC, UNF, UNEF) ANSI B1.1-1982	729
		API API SPEC 7:2001 (0.040 0.038R 0.050)	759
		API BUTTRESS CASING API SPEC 5B:2008 OIL THREADS	760
		API ROUND CASING & TUBING API SPEC 5B:2008	761
		BSPT B.S.21: 1985	739
		EXTREME LINE CASING API SPEC 5B:2008 - OIL THREADS	762
		ISO METRIC ISO 965-1: 1999-11 DIN 13: 2005-08	725
		METRIC BUTTRESS SAGENGEWINDE (DIN 513:1985) SAW THREAD	758

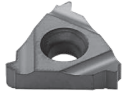
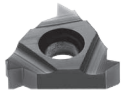
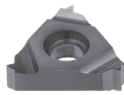
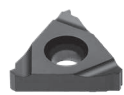
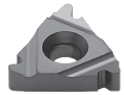
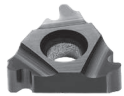
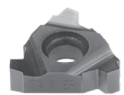
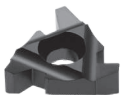
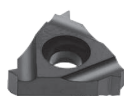
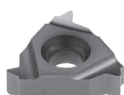
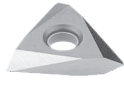
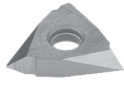
	Insert Image	Description	Page
Full Profile		MJ ISO 5855-1:1989	756
		NPT ANSI/ASME B 1.20.1-1983	740
		NPTF ANSI B 1.20.3-1976	742
		PG DIN 40430; 1971	763
		ROUND (DIN 20400) DIN 20400:1990	745
		ROUND (DIN 405) DIN 405:1997	744
		STUB ACME ANSI/ASME: 1.8-1988	750
		TRAPEZ DIN 103:1977 ISO 2901:1993	746
		UNJ MIL-S-8879A	752
		WITHWORTH FOR BSW, BSF, BSP, B.S.84: 1956, DIN 259, ISO 228-1:1994	734
Tangential Profile		TNMC	765
		TPMC	765

PARTIAL PROFILE INSERTS CODE KEY

Chave do codificação de pastilhas | Llave de codificación de plaquitas

Partial Profile Example

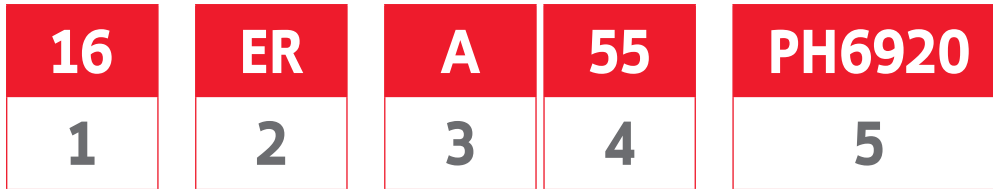

1 - Insert Size						
L	06	08	11	16	22	27
I.C.	4.00	5.00	6.35	9.525	12.70	15.875

2 - Insert Hand Type	
ER	External Right Holder
EL	External Left Holder
IR	Internal Right Holder
IL	Internal Left Holder

3 - Profile Type		
symbol	mm	tpi
A	0.5 - 1.5	48 - 16
G	1.75 - 3.0	14 - 8
AG	0.5 - 3.0	48 - 8
N	3.5 - 5.0	7 - 5
Q	5.5 - 6.0	4.5 - 4

4 - Profile Angle	
55	55°
60	60°

5 - Grades
PH6920

PARTIAL PROFILE 60°

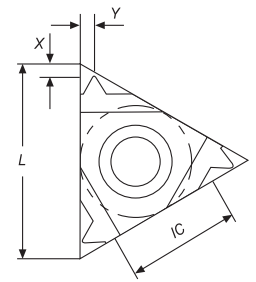
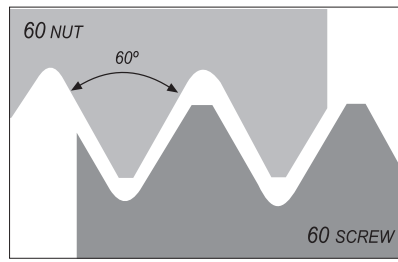
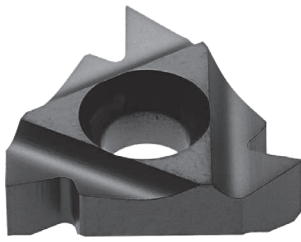

External

Geometry code ⁽¹⁾	Reference Referência Referencia	Pitch		Dimensions Dimensões Dimensiones (mm)				Stock - Grade Code ⁽²⁾ (68) PH6920
		MM	TPI	IC	L	X	Y	
1880592	11 ER A60	0.5-1.5	48-16	6.35	11	0.8	0.9	☉
1880429	16 ER A60	0.5-1.5	48-16	9.525	16	0.8	0.9	☉
1880431	16 ER G60	1.75-3.0	14-8	9.525	16	1.2	1.7	☉
1880388	16 ER AG60	0.5-3.0	48-8	9.525	16	1.2	1.7	☉
1880046	22 ER N60	3.5-5.0	7-5	12.70	22	1.7	2.5	☉
1882486	27 ER Q60	5.5-6.0	4.5-4	15.875	27	2.1	3.1	☉
1881851	11 EL A60	0.5-1.5	48-16	6.35	11	0.8	0.9	☉
1880771	16 EL A60	0.5-1.5	48-16	9.525	16	0.8	0.9	☉
1880773	16 EL G60	1.75-3.0	14-8	9.525	16	1.2	1.7	☉
1880524	16 EL AG60	0.5-3.0	48-8	9.525	16	1.2	1.7	☉
1880853	22 EL N60	3.5-5.0	7-5	12.70	22	1.7	2.5	☉
1882155	27 EL Q60	5.5-6.0	4.5-4	15.875	27	2.1	3.1	☉

☉ Stock item | Produto de stock | Itens de stock

☉ Available under request | Disponível sobre consulta | Disponible bajo consulta

Insert order code = (1) Geometry Code + (2) Grade Code

Internal

Geometry code ⁽¹⁾	Reference Referência Referencia	Pitch		Dimensions Dimensões Dimensiones (mm)				Stock - Grade Code ⁽²⁾ (68) PH6920
		MM	TPI	IC	L	X	Y	
1881730	06 IR A60	0.5-1.25	48-20	4.00	06	0.6	0.6	☉
1881773	08 IR A60	0.5-1.5	48-16	5.00	08	0.6	0.7	☉
1880595	11 IR A60	0.5-1.5	48-16	6.35	11	0.8	0.9	☉
1880045	16 IR A60	0.5-1.5	48-16	9.525	16	0.8	0.9	☉
1880435	16 IR G60	1.75-3.0	14-8	9.525	16	1.2	1.7	☉
1880437	16 IR AG60	0.5-3.0	48-8	9.525	16	1.2	1.7	☉
1880769	22 IR N60	3.5-5.0	7-5	12.70	22	1.7	2.5	☉
1882487	27 IR Q60	5.5-6.0	4.5-4	15.875	27	2.1	3.1	☉
1881716	06 IL A60	0.5-1.25	48-20	4.00	06	0.6	0.6	☉
1882199	08 IL A60	0.5-1.5	48-16	5.00	08	0.6	0.7	☉
1880855	11 IL A60	0.5-1.5	48-16	6.35	11	0.8	0.9	☉
1880772	16 IL A60	0.5-1.5	48-16	9.525	16	0.8	0.9	☉
1880774	16 IL G60	1.75-3.0	14-8	9.525	16	1.2	1.7	☉
1880775	16 IL AG60	0.5-3.0	48-8	9.525	16	1.2	1.7	☉
1880854	22 IL N60	3.5-5.0	7-5	12.70	22	1.7	2.5	☉
1882179	27 IL Q60	5.5-6.0	4.5-4	15.875	27	2.1	3.1	☉

☉ Stock item | Produto de stock | Itens de stock

☉ Available under request | Disponível sobre consulta | Disponible bajo consulta

Insert order code = (1) Geometry Code + (2) Grade Code

PARTIAL PROFILE 55°

mm

THREADING

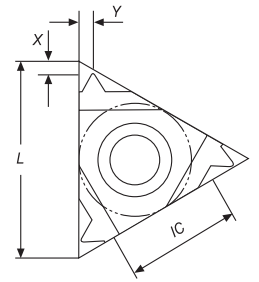
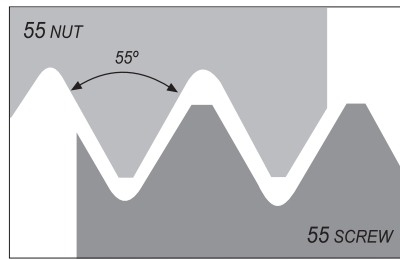
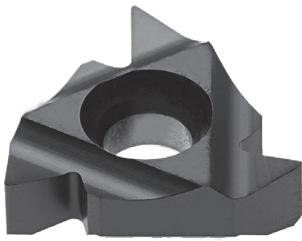

External

Geometry code ⁽¹⁾	Reference Referência Referencia	Pitch		Dimensions Dimensões Dimensiones (mm)				Stock - Grade Code ⁽²⁾
		MM	TPI	IC	L	X	Y	(68) PH6920
1880598	11 ER A55	0.5-1.5	48-16	6.35	11	0.8	0.9	⊗
1880430	16 ER A55	0.5-1.5	48-16	9.525	16	0.8	0.9	⊗
1880432	16 ER G55	1.75-3.0	14-8	9.525	16	1.2	1.7	⊗
1880433	16 ER AG55	0.5-3.0	48-8	9.525	16	1.2	1.7	⊗
1880770	22 ER N55	3.5-5.0	7-5	12.70	22	1.7	2.5	⊗
1882167	27 ER Q55	5.5-6.0	4.5-4	15.875	27	2.0	2.9	○
1881850	11 EL A55	0.5-1.5	48-16	6.35	11	0.8	0.9	○
1880776	16 EL A55	0.5-1.5	48-16	9.525	16	0.8	0.9	○
1880778	16 EL G55	1.75-3.0	14-8	9.525	16	1.2	1.7	○
1880780	16 EL AG55	0.5-3.0	48-8	9.525	16	1.2	1.7	○
1880858	22 EL N55	3.5-5.0	7-5	12.70	22	1.7	2.5	○
1882154	27 EL Q55	5.5-6.0	4.5-4	15.875	27	2.0	2.9	○

⊗ Stock item | Produto de stock | Itens de stock

○ Available under request | Disponível sobre consulta | Disponible bajo consulta

Insert order code = (1) Geometry Code + (2) Grade Code

Thread turning - Inserts

Thread turning - Toolholders

Thread turning - Spare Parts

Technical Data

Internal

Geometry code ⁽¹⁾	Reference Referência Referencia	Pitch		Dimensions Dimensões Dimensiones (mm)				Stock - Grade Code ⁽²⁾
		MM	TPI	IC	L	X	Y	(68) PH6920
1881729	06 IR A55	0.5-1.25	48-20	4.00	06	0.5	0.6	○
1881772	08 IR A55	0.5-1.5	48-16	5.00	08	0.6	0.7	○
1880006	11 IR A55	0.5-1.5	48-16	6.35	11	0.8	0.9	⊗
1880434	16 IR A55	0.5-1.5	48-16	9.525	16	0.8	0.9	⊗
1880436	16 IR G55	1.75-3.0	14-8	9.525	16	1.2	1.7	⊗
1880438	16 IR AG55	0.5-3.0	48-8	9.525	16	1.2	1.7	⊗
1880047	22 IR N55	3.5-5.0	7-5	12.70	22	1.7	2.5	⊗
1882189	27 IR Q55	5.5-6.0	4.5-4	15.875	27	2.0	2.9	○
1881715	06 IL A55	0.5-1.25	48-20	4.00	06	0.5	0.6	○
1881751	08 IL A55	0.5-1.5	48-16	5.00	08	0.6	0.7	○
1880856	11 IL A55	0.5-1.5	48-16	6.35	11	0.8	0.9	○
1880777	16 IL A55	0.5-1.5	48-16	9.525	16	0.8	0.9	○
1880779	16 IL G55	1.75-3.0	14-8	9.525	16	1.2	1.7	○
1880781	16 IL AG55	0.5-3.0	48-8	9.525	16	1.2	1.7	⊗
1880857	22 IL N55	3.5-5.0	7-5	12.70	22	1.7	2.5	○
1882178	27 IL Q55	5.5-6.0	4.5-4	15.875	27	2.0	2.9	○

⊗ Stock item | Produto de stock | Itens de stock

○ Available under request | Disponível sobre consulta | Disponible bajo consulta

Insert order code = (1) Geometry Code + (2) Grade Code

FULL PROFILE INSERTS CODE KEY

Chave do codificação de pastilhas | Llave de codificación de plaquitas

Full Profile Example



1 - Insert Size

L	06	08	11	16	22	27
I.C.	4.00	5.00	6.35	9.525	12.70	15.875

2 - Insert Hand Type

ER	External Right Holder
EL	External Left Holder
IR	Internal Right Holder
IL	Internal Left Holder

3 - Pitch

mm	tpi
0.35 - 7.0	72 - 3

4 - Profile Type

symbol	profile type	symbol	profile type	symbol	profile type	symbol	profile type
ISO	ISO METRIC	NPTF	NPTF	STACME	STUB ACME	API	API
UN	AMERICAN UN	RD	ROUND (DIN 405)	UNJ	UNJ	BUT	API BUTTRESS CASING
W	WITHWORTH	RD20400	ROUND (DIN 20400)	MJ	MJ	API RD	API ROUND CAS. & TUBING
BSPT	BSPT	TR	TRAPEZ	ABUT	AMERICAN BUTTRESS	EL	EXTREME LINE CASING
NPT	NPT	ACME	AMERICAN ACME	SAGE	METRIC BUT. SAGENGWINDE	PG	PG

5 - Grades

PH6920

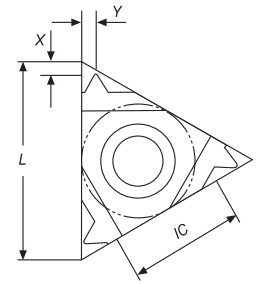
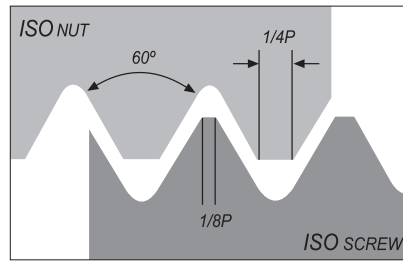
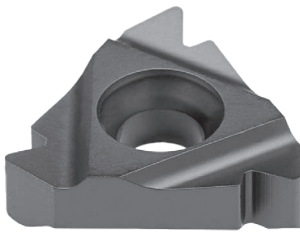

External

Geometry code ⁽¹⁾	Reference Referência Referencia	Pitch MM	Dimensions Dimensões Dimensiones (mm)				Stock - Grade Code ⁽²⁾ (68) PH6920
			IC	L	X	Y	
1881852	11 ER 0.35 ISO	0.35	6.35	11	0.8	0.4	○
1881853	11 ER 0.40 ISO	0.40	6.35	11	0.7	0.4	○
1881854	11 ER 0.45 ISO	0.45	6.35	11	0.7	0.4	○
1881855	11 ER 0.50 ISO	0.50	6.35	11	0.6	0.6	○
1881856	11 ER 0.60 ISO	0.60	6.35	11	0.6	0.6	○
1881857	11 ER 0.70 ISO	0.70	6.35	11	0.6	0.6	○
1881858	11 ER 0.75 ISO	0.75	6.35	11	0.6	0.6	⊗
1881859	11 ER 0.80 ISO	0.80	6.35	11	0.6	0.6	○
1880602	11 ER 1.00 ISO	1.00	6.35	11	0.7	0.7	⊗
1881861	11 ER 1.25 ISO	1.25	6.35	11	0.8	0.9	⊗
1880603	11 ER 1.50 ISO	1.50	6.35	11	0.8	1.0	⊗
1881864	11 ER 1.75 ISO	1.75	6.35	11	0.8	1.1	○
1881881	11 ER 2.00 ISO	2.00	6.35	11	0.8	1.1	○
1882030	16 ER 0.35 ISO	0.35	9.525	16	0.8	0.4	○
1882031	16 ER 0.40 ISO	0.40	9.525	16	0.7	0.4	○
1882032	16 ER 0.45 ISO	0.45	9.525	16	0.7	0.4	○
1880819	16 ER 0.50 ISO	0.50	9.525	16	0.6	0.6	○
1882033	16 ER 0.60 ISO	0.60	9.525	16	0.6	0.6	○
1882034	16 ER 0.70 ISO	0.70	9.525	16	0.6	0.6	○
1880447	16 ER 0.75 ISO	0.75	9.525	16	0.6	0.6	⊗
1880804	16 ER 0.80 ISO	0.80	9.525	16	0.6	0.6	⊗
1880479	16 ER 1.00 ISO	1.00	9.525	16	0.7	0.7	⊗
1880007	16 ER 1.25 ISO	1.25	9.525	16	0.8	0.9	⊗
1880262	16 ER 1.50 ISO	1.50	9.525	16	0.8	1.0	⊗
1880732	16 ER 1.75 ISO	1.75	9.525	16	0.9	1.2	⊗
1880018	16 ER 2.00 ISO	2.00	9.525	16	1.0	1.3	⊗
1880020	16 ER 2.50 ISO	2.50	9.525	16	1.1	1.5	⊗
1880022	16 ER 3.00 ISO	3.00	9.525	16	1.2	1.6	⊗
1883740	16 ER 3.50 ISO	3.50	9.525	16	1.2	1.7	○
1880823	22 ER 3.50 ISO	3.50	12.70	22	1.6	2.3	⊗
1880811	22 ER 4.00 ISO	4.00	12.70	22	1.6	2.3	⊗
1880824	22 ER 4.50 ISO	4.50	12.70	22	1.7	2.4	⊗
1880649	22 ER 5.00 ISO	5.00	12.70	22	1.7	2.5	⊗
1883741	22 ER 5.50 ISO	5.50	12.70	22	1.7	2.6	○
1883742	22 ER 6.00 ISO	6.00	12.70	22	1.9	2.7	○
1882163	27 ER 5.50 ISO	5.50	15.875	27	1.6	2.3	○
1882164	27 ER 6.00 ISO	6.00	15.875	27	1.8	2.5	○

Stock item | Produto de stock | Itens de stock

Available under request | Disponível sobre consulta | Disponible bajo consulta

Insert order code = (1) Geometry Code + (2) Grade Code

mm THREADING Thread milling - Inserts Thread milling - Toolholders Thread turning - Overview Thread turning - Inserts Thread turning - Toolholders Thread turning - Spare Parts Technical Data

External

Geometry code ⁽¹⁾	Reference Referência Referencia	Pitch	Dimensions Dimensões Dimensiones (mm)				Stock - Grade Code ⁽²⁾
		MM	IC	L	X	Y	(68) PH6920
1881794	11 EL 0.35 ISO	0.35	6.35	11	0.8	0.4	○
1881795	11 EL 0.40 ISO	0.40	6.35	11	0.7	0.4	○
1881796	11 EL 0.45 ISO	0.45	6.35	11	0.7	0.4	○
1881797	11 EL 0.50 ISO	0.50	6.35	11	0.6	0.6	○
1881798	11 EL 0.60 ISO	0.60	6.35	11	0.6	0.6	○
1881799	11 EL 0.70 ISO	0.70	6.35	11	0.6	0.6	○
1881800	11 EL 0.75 ISO	0.75	6.35	11	0.6	0.6	○
1881801	11 EL 0.80 ISO	0.80	6.35	11	0.6	0.6	○
1881802	11 EL 1.00 ISO	1.00	6.35	11	0.7	0.7	○
1881803	11 EL 1.25 ISO	1.25	6.35	11	0.8	0.9	○
1881804	11 EL 1.50 ISO	1.50	6.35	11	0.8	1.0	○
1881806	11 EL 1.75 ISO	1.75	6.35	11	0.8	1.1	○
1880654	11 EL 2.00 ISO	2.00	6.35	11	0.8	1.1	○
1881977	16 EL 0.35 ISO	0.35	9.525	16	0.8	0.4	○
1881978	16 EL 0.40 ISO	0.40	9.525	16	0.7	0.4	○
1881979	16 EL 0.45 ISO	0.45	9.525	16	0.7	0.4	○
1881980	16 EL 0.50 ISO	0.50	9.525	16	0.6	0.6	○
1881981	16 EL 0.60 ISO	0.60	9.525	16	0.6	0.6	○
1881982	16 EL 0.70 ISO	0.70	9.525	16	0.6	0.6	○
1881983	16 EL 0.75 ISO	0.75	9.525	16	0.6	0.6	⊗
1881984	16 EL 0.80 ISO	0.80	9.525	16	0.6	0.6	○
1880782	16 EL 1.00 ISO	1.00	9.525	16	0.7	0.7	⊗
1880651	16 EL 1.25 ISO	1.25	9.525	16	0.8	0.9	⊗
1880652	16 EL 1.50 ISO	1.50	9.525	16	0.8	1.0	○
1880653	16 EL 1.75 ISO	1.75	9.525	16	0.9	1.2	⊗
1882519	16 EL 2.00 ISO	2.00	9.525	16	1.0	1.3	⊗
1880788	16 EL 2.50 ISO	2.50	9.525	16	1.1	1.5	⊗
1880488	16 EL 3.00 ISO	3.00	9.525	16	1.2	1.6	○
1883743	16 EL 3.50 ISO	3.50	9.525	16	1.2	1.7	○
1880844	22 EL 3.50 ISO	3.50	12.70	22	1.6	2.3	○
1880845	22 EL 4.00 ISO	4.00	12.70	22	1.6	2.3	○
1880846	22 EL 4.50 ISO	4.50	12.70	22	1.7	2.4	○
1880847	22 EL 5.00 ISO	5.00	12.70	22	1.7	2.5	○
1883744	22 EL 5.50 ISO	5.50	12.70	22	1.7	2.6	○
1883745	22 EL 6.00 ISO	6.00	12.70	22	1.9	2.7	○
1882150	27 EL 5.50 ISO	5.50	15.875	27	1.6	2.3	○
1882151	27 EL 6.00 ISO	6.00	15.875	27	1.8	2.5	○

 Stock item | Produto de stock | Itens de stock
  Available under request | Disponível sobre consulta | Disponible bajo consulta
 Insert order code = (1) Geometry Code + (2) Grade Code

mm
 THREADING
 Thread milling - Inserts
 Thread milling - Toolholders
 Thread turning - Overview
 Thread turning - Inserts
 Thread turning - Toolholders
 Thread turning - Spare Parts
 Technical Data

Internal

Geometry code ⁽¹⁾	Reference Referência Referencia	Pitch	Dimensions Dimensões Dimensiones (mm)				Stock - Grade Code ⁽²⁾
		MM	IC	L	X	Y	(68) PH6920
1881717	06 IR 0.50 ISO	0.50	4.00	06	0.9	0.5	○
1881718	06 IR 0.75 ISO	0.75	4.00	06	0.8	0.5	○
1881719	06 IR 1.00 ISO	1.00	4.00	06	0.7	0.6	○
1881720	06 IR 1.25 ISO	1.25	4.00	06	0.6	0.6	○
1881752	08 IR 0.35 ISO	0.35	5.00	08	0.7	0.4	○
1881753	08 IR 0.50 ISO	0.50	5.00	08	0.6	0.5	○
1881754	08 IR 0.75 ISO	0.75	5.00	08	0.6	0.5	○
1881755	08 IR 1.00 ISO	1.00	5.00	08	0.6	0.6	○
1881756	08 IR 1.25 ISO	1.25	5.00	08	0.6	0.7	○
1881757	08 IR 1.50 ISO	1.50	5.00	08	0.6	0.7	○
1881758	08 IR 1.75 ISO	1.75	5.00	08	0.6	0.8	○
1881937	11 IR 0.35 ISO	0.35	6.35	11	0.8	0.3	○
1881938	11 IR 0.40 ISO	0.40	6.35	11	0.8	0.4	○
1881939	11 IR 0.45 ISO	0.45	6.35	11	0.8	0.4	○
1880825	11 IR 0.50 ISO	0.50	6.35	11	0.6	0.6	○
1881940	11 IR 0.60 ISO	0.60	6.35	11	0.6	0.6	○
1881941	11 IR 0.70 ISO	0.70	6.35	11	0.6	0.6	○
1880762	11 IR 0.75 ISO	0.75	6.35	11	0.6	0.6	⊗
1881942	11 IR 0.80 ISO	0.80	6.35	11	0.6	0.6	○
1880604	11 IR 1.00 ISO	1.00	6.35	11	0.8	0.7	⊗
1880827	11 IR 1.25 ISO	1.25	6.35	11	0.8	0.8	⊗
1880605	11 IR 1.50 ISO	1.50	6.35	11	0.8	1.0	⊗
1880828	11 IR 1.75 ISO	1.75	6.35	11	0.8	1.1	⊗
1880829	11 IR 2.00 ISO	2.00	6.35	11	0.8	0.9	⊗
1883746	11 IR 2.50 ISO	2.50	6.35	11	0.8	1.2	○
1882108	16 IR 0.35 ISO	0.35	9.525	16	0.8	0.3	○
1882109	16 IR 0.40 ISO	0.40	9.525	16	0.8	0.4	○
1882110	16 IR 0.45 ISO	0.45	9.525	16	0.8	0.4	○
1880830	16 IR 0.50 ISO	0.50	9.525	16	0.6	0.6	⊗
1882112	16 IR 0.60 ISO	0.60	9.525	16	0.6	0.6	○
1882113	16 IR 0.70 ISO	0.70	9.525	16	0.6	0.6	○
1880831	16 IR 0.75 ISO	0.75	9.525	16	0.6	0.6	⊗
1880832	16 IR 0.80 ISO	0.80	9.525	16	0.6	0.6	○
1880025	16 IR 1.00 ISO	1.00	9.525	16	0.6	0.7	⊗
1880026	16 IR 1.25 ISO	1.25	9.525	16	0.8	0.9	⊗
1880619	16 IR 1.50 ISO	1.50	9.525	16	0.8	1.0	⊗
1880733	16 IR 1.75 ISO	1.75	9.525	16	0.9	1.2	⊗
1880039	16 IR 2.00 ISO	2.00	9.525	16	1.0	1.3	⊗
1880041	16 IR 2.50 ISO	2.50	9.525	16	1.1	1.5	⊗
1880042	16 IR 3.00 ISO	3.00	9.525	16	1.1	1.5	⊗
1883747	16 IR 3.50 ISO	3.50	9.525	16	1.2	1.7	⊗
1880834	22 IR 3.50 ISO	3.50	12.70	22	1.6	2.3	⊗
1880818	22 IR 4.00 ISO	4.00	12.70	22	1.6	2.3	⊗
1880835	22 IR 4.50 ISO	4.50	12.70	22	1.6	2.4	○
1880650	22 IR 5.00 ISO	5.00	12.70	22	1.6	2.3	⊗
1883748	22 IR 5.50 ISO	5.50	12.70	22	1.6	2.3	○
1883749	22 IR 6.00 ISO	6.00	12.70	22	1.6	2.4	○
1882185	27 IR 5.50 ISO	5.50	15.875	27	1.6	2.3	⊗
1882186	27 IR 6.00 ISO	6.00	15.875	27	1.8	2.5	○

Stock item | Produto de stock | Itens de stock

Available under request | Disponível sobre consulta | Disponible bajo consulta

Insert order code = (1) Geometry Code + (2) Grade Code

mm
THREADING
Thread milling - Inserts
Thread milling - Toolholders
Thread turning - Overview
Thread turning - Inserts
Thread turning - Toolholders
Thread turning - Spare Parts
Technical Data

ISO METRIC ISO 965-1: 1999-11 | DIN 13: 2005-08

Internal

Geometry code ⁽¹⁾	Reference Referência Referencia	Pitch	Dimensions Dimensões Dimensiones (mm)				Stock - Grade Code ⁽²⁾
		MM	IC	L	X	Y	(68) PH6920
1881703	06 IL 0.50 ISO	0.50	4.00	06	0.9	0.5	○
1881704	06 IL 0.75 ISO	0.75	4.00	06	0.8	0.5	○
1881705	06 IL 1.00 ISO	1.00	4.00	06	0.7	0.6	○
1881706	06 IL 1.25 ISO	1.25	4.00	06	0.6	0.6	○
1881732	08 IL 0.50 ISO	0.50	5.00	08	0.6	0.5	○
1881733	08 IL 0.75 ISO	0.75	5.00	08	0.6	0.5	○
1881734	08 IL 1.00 ISO	1.00	5.00	08	0.6	0.6	○
1881735	08 IL 1.25 ISO	1.25	5.00	08	0.6	0.7	○
1881736	08 IL 1.50 ISO	1.50	5.00	08	0.6	0.7	○
1881737	08 IL 1.75 ISO	1.75	5.00	08	0.6	0.8	○
1881911	11 IL 0.35 ISO	0.35	6.35	11	0.8	0.3	○
1881912	11 IL 0.40 ISO	0.40	6.35	11	0.8	0.4	○
1881913	11 IL 0.45 ISO	0.45	6.35	11	0.8	0.4	○
1880837	11 IL 0.50 ISO	0.50	6.35	11	0.6	0.6	○
1881914	11 IL 0.60 ISO	0.60	6.35	11	0.6	0.6	○
1881915	11 IL 0.70 ISO	0.70	6.35	11	0.6	0.6	○
1880838	11 IL 0.75 ISO	0.75	6.35	11	0.6	0.6	○
1881916	11 IL 0.80 ISO	0.80	6.35	11	0.6	0.6	○
1880839	11 IL 1.00 ISO	1.00	6.35	11	0.8	0.7	○
1880840	11 IL 1.25 ISO	1.25	6.35	11	0.8	0.8	○
1880841	11 IL 1.50 ISO	1.50	6.35	11	0.8	1.0	○
1880842	11 IL 1.75 ISO	1.75	6.35	11	0.8	1.1	○
1880843	11 IL 2.00 ISO	2.00	6.35	11	0.8	0.9	⊗
1883750	11 IL 2.50 ISO	2.50	6.35	11	0.8	1.2	○
1882058	16 IL 0.35 ISO	0.35	9.525	16	0.8	0.3	○
1882059	16 IL 0.40 ISO	0.40	9.525	16	0.8	0.4	○
1882060	16 IL 0.45 ISO	0.45	9.525	16	0.8	0.4	○
1882061	16 IL 0.50 ISO	0.50	9.525	16	0.6	0.6	○
1882062	16 IL 0.60 ISO	0.60	9.525	16	0.6	0.6	○
1882063	16 IL 0.70 ISO	0.70	9.525	16	0.6	0.6	○
1882064	16 IL 0.75 ISO	0.75	9.525	16	0.6	0.6	○
1882065	16 IL 0.80 ISO	0.80	9.525	16	0.6	0.6	○
1880783	16 IL 1.00 ISO	1.00	9.525	16	0.6	0.7	⊗
1880784	16 IL 1.25 ISO	1.25	9.525	16	0.8	0.9	⊗
1880785	16 IL 1.50 ISO	1.50	9.525	16	0.8	1.0	⊗
1880786	16 IL 1.75 ISO	1.75	9.525	16	0.9	1.2	⊗
1880787	16 IL 2.00 ISO	2.00	9.525	16	1.0	1.3	⊗
1880789	16 IL 2.50 ISO	2.50	9.525	16	1.1	1.5	⊗
1880790	16 IL 3.00 ISO	3.00	9.525	16	1.1	1.5	⊗
1883751	16 IL 3.50 ISO	3.50	9.525	16	1.2	1.7	○
1880848	22 IL 3.50 ISO	3.50	12.70	22	1.6	2.3	○
1880849	22 IL 4.00 ISO	4.00	12.70	22	1.6	2.3	○
1880850	22 IL 4.50 ISO	4.50	12.70	22	1.6	2.4	○
1880851	22 IL 5.00 ISO	5.00	12.70	22	1.6	2.3	○
1883752	22 IL 5.50 ISO	5.50	12.70	22	1.6	2.3	○
1883753	22 IL 6.00 ISO	6.00	12.70	22	1.6	2.4	○
1882174	27 IL 5.50 ISO	5.50	15.875	27	1.6	2.3	○
1882175	27 IL 6.00 ISO	6.00	15.875	27	1.8	2.5	○

⊗ Stock item | Produto de stock | Itens de stock

○ Available under request | Disponível sobre consulta | Disponible bajo consulta

Insert order code = (1) Geometry Code + (2) Grade Code

AMERICAN UN (UNC, UNF, UNEF) | ANSI B1.1-1982

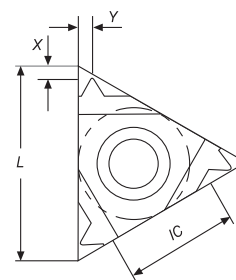
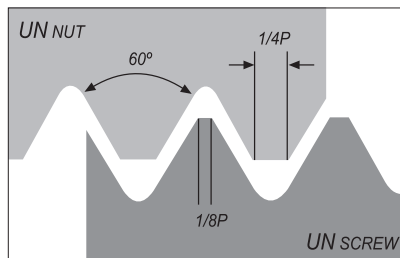
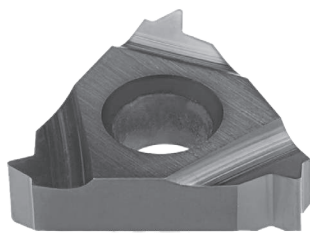

External

Geometry code ⁽¹⁾	Reference Referência Referencia	Pitch TPI	Dimensions Dimensões Dimensiones (mm)				Stock - Grade Code ⁽²⁾ (68) PH6920
			IC	L	X	Y	
1881907	11 ER 72 UN	72	6.35	11	0.8	0.4	○
1881906	11 ER 64 UN	64	6.35	11	0.8	0.4	○
1881903	11 ER 56 UN	56	6.35	11	0.7	0.4	○
1881901	11 ER 48 UN	48	6.35	11	0.6	0.6	○
1881900	11 ER 44 UN	44	6.35	11	0.6	0.6	○
1881898	11 ER 40 UN	40	6.35	11	0.6	0.6	○
1881896	11 ER 36 UN	36	6.35	11	0.6	0.6	○
1881894	11 ER 32 UN	32	6.35	11	0.6	0.6	○
1881892	11 ER 28 UN	28	6.35	11	0.6	0.7	○
1881890	11 ER 27 UN	27	6.35	11	0.7	0.8	○
1881885	11 ER 24 UN	24	6.35	11	0.7	0.8	○
1881882	11 ER 20 UN	20	6.35	11	0.8	0.9	○
1881877	11 ER 18 UN	18	6.35	11	0.8	1.0	○
1881873	11 ER 16 UN	16	6.35	11	0.9	1.1	○
1881869	11 ER 14 UN	14	6.35	11	0.9	1.1	○
1882055	16 ER 72 UN	72	9.525	16	0.8	0.3	○
1882054	16 ER 64 UN	64	9.525	16	0.8	0.4	○
1882051	16 ER 56 UN	56	9.525	16	0.7	0.4	○
1882049	16 ER 48 UN	48	9.525	16	0.6	0.6	○
1882048	16 ER 44 UN	44	9.525	16	0.6	0.6	○
1882046	16 ER 40 UN	40	9.525	16	0.6	0.6	○
1882044	16 ER 36 UN	36	9.525	16	0.6	0.6	○
1880870	16 ER 32 UN	32	9.525	16	0.6	0.6	○
1880869	16 ER 28 UN	28	9.525	16	0.6	0.7	○
1882041	16 ER 27 UN	27	9.525	16	0.7	0.8	○
1880868	16 ER 24 UN	24	9.525	16	0.7	0.8	⊗
1880021	16 ER 20 UN	20	9.525	16	0.8	0.9	○
1880867	16 ER 18 UN	18	9.525	16	0.8	1.0	○
1880616	16 ER 16 UN	16	9.525	16	0.9	1.1	⊗
1880014	16 ER 14 UN	14	9.525	16	1.0	1.2	⊗
1880866	16 ER 13 UN	13	9.525	16	1.0	1.3	⊗
1880865	16 ER 12 UN	12	9.525	16	1.1	1.4	○
1883754	16 ER 11.5 UN	11.5	9.525	16	1.1	1.5	○
1880864	16 ER 11 UN	11	9.525	16	1.1	1.5	○
1880863	16 ER 10 UN	10	9.525	16	1.1	1.5	⊗
1880862	16 ER 9 UN	9	9.525	16	1.2	1.7	⊗

⊗ Stock item | Produto de stock | Itens de stock

○ Available under request | Disponível sobre consulta | Disponible bajo consulta

Insert order code = (1) Geometry Code + (2) Grade Code

AMERICAN UN (UNC, UNF, UNEF) | ANSI B1.1-1982

External

Geometry code ⁽¹⁾	Reference Referência Referencia	Pitch TPI	Dimensions Dimensões Dimensiones (mm)				Stock - Grade Code ⁽²⁾ (68) PH6920
			IC	L	X	Y	
1880024	16 ER 8 UN	8	9.525	16	1.2	1.6	○
1880861	22 ER 7 UN	7	12.70	22	1.6	2.3	○
1880860	22 ER 6 UN	6	12.70	22	1.6	2.3	⊗
1880859	22 ER 5 UN	5	12.70	22	1.7	2.5	○
1882157	27 ER 4.5 UN	4.5	15.875	27	1.9	2.7	○
1882161	27 ER 4 UN	4	15.875	27	2.1	3.0	○
1881848	11 EL 72 UN	72	6.35	11	0.8	0.4	○
1881847	11 EL 64 UN	64	6.35	11	0.8	0.4	○
1882200	11 EL 56 UN	56	6.35	11	0.7	0.4	○
1881843	11 EL 48 UN	48	6.35	11	0.6	0.6	○
1881842	11 EL 44 UN	44	6.35	11	0.6	0.6	○
1881840	11 EL 40 UN	40	6.35	11	0.6	0.6	○
1881838	11 EL 36 UN	36	6.35	11	0.6	0.6	○
1881836	11 EL 32 UN	32	6.35	11	0.6	0.6	○
1881834	11 EL 28 UN	28	6.35	11	0.6	0.7	○
1881832	11 EL 27 UN	27	6.35	11	0.7	0.8	○
1881827	11 EL 24 UN	24	6.35	11	0.7	0.8	○
1881824	11 EL 20 UN	20	6.35	11	0.8	0.9	○
1881819	11 EL 18 UN	18	6.35	11	0.8	1.0	○
1881815	11 EL 16 UN	16	6.35	11	0.9	1.1	○
1881811	11 EL 14 UN	14	6.35	11	0.9	1.1	○
1882022	16 EL 72 UN	72	9.525	16	0.8	0.3	○
1882020	16 EL 64 UN	64	9.525	16	0.8	0.4	○
1882017	16 EL 56 UN	56	9.525	16	0.7	0.4	○
1882015	16 EL 48 UN	48	9.525	16	0.6	0.6	○
1882014	16 EL 44 UN	44	9.525	16	0.6	0.6	○
1882012	16 EL 40 UN	40	9.525	16	0.6	0.6	○
1882010	16 EL 36 UN	36	9.525	16	0.6	0.6	○
1880886	16 EL 32 UN	32	9.525	16	0.6	0.6	○
1880885	16 EL 28 UN	28	9.525	16	0.6	0.7	○
1882007	16 EL 27 UN	27	9.525	16	0.7	0.8	○
1880884	16 EL 24 UN	24	9.525	16	0.7	0.8	○
1880883	16 EL 20 UN	20	9.525	16	0.8	0.9	○
1880882	16 EL 18 UN	18	9.525	16	0.8	1.0	○
1880881	16 EL 16 UN	16	9.525	16	0.9	1.1	○
1880880	16 EL 14 UN	14	9.525	16	1.0	1.2	○
1880879	16 EL 13 UN	13	9.525	16	1.0	1.3	○
1880878	16 EL 12 UN	12	9.525	16	1.1	1.4	○
1883755	16 EL 11.5 UN	11.5	9.525	16	1.1	1.5	○
1880877	16 EL 11 UN	11	9.525	16	1.1	1.5	○
1880876	16 EL 10 UN	10	9.525	16	1.1	1.5	○
1880875	16 EL 9 UN	9	9.525	16	1.2	1.7	○
1880874	16 EL 8 UN	8	9.525	16	1.2	1.6	○
1880873	22 EL 7U N	7	12.70	22	1.6	2.3	○
1880872	22 EL 6 UN	6	12.70	22	1.6	2.3	○
1880871	22 EL 5 UN	5	12.70	22	1.7	2.5	○
1882144	27 EL 4.5 UN	4.5	15.875	27	1.9	2.7	○
1882148	27 EL 4 UN	4	15.875	27	2.1	3.0	○

⊗ Stock item | Produto de stock | Itens de stock

○ Available under request | Disponível sobre consulta | Disponible bajo consulta

Insert order code = (1) Geometry Code + (2) Grade Code

Internal

Geometry code ⁽¹⁾	Reference Referência Referencia	Pitch	Dimensions Dimensões Dimensiones (mm)				Stock - Grade Code ⁽²⁾
		TPI	IC	L	X	Y	(68) PH6920
1881726	06 IR 32 UN	32	4.00	06	0.8	0.5	○
1881725	06 IR 28 UN	28	4.00	06	0.8	0.6	○
1881722	06 IR 24 UN	24	4.00	06	0.7	0.6	○
1883756	06 IR 20 UN	20	4.00	06	0.6	0.6	○
1881721	06 IR 18 UN	18	4.00	06	0.6	0.7	○
1881769	08 IR 32 UN	32	5.00	08	0.6	0.5	○
1881768	08 IR 28 UN	28	5.00	08	0.6	0.6	○
1881765	08 IR 24 UN	24	5.00	08	0.6	0.6	○
1881764	08 IR 20 UN	20	5.00	08	0.6	0.7	⊗
1881762	08 IR 18 UN	18	5.00	08	0.6	0.7	○
1881760	08 IR 16 UN	16	5.00	08	0.6	0.7	○
1881759	08 IR 14 UN	14	5.00	08	0.6	0.8	○
1881956	11 IR 72 UN	72	6.35	11	0.8	0.3	○
1881955	11 IR 64 UN	64	6.35	11	0.8	0.4	○
1881954	11 IR 56 UN	56	6.35	11	0.7	0.4	○
1881953	11 IR 48 UN	48	6.35	11	0.6	0.6	○
1881952	11 IR 44 UN	44	6.35	11	0.6	0.6	○
1881951	11 IR 40 UN	40	6.35	11	0.6	0.6	○
1881950	11 IR 36 UN	36	6.35	11	0.6	0.6	○
1880910	11 IR 32 UN	32	6.35	11	0.6	0.6	○
1880909	11 IR 28 UN	28	6.35	11	0.6	0.7	○
1881948	11 IR 27 UN	27	6.35	11	0.7	0.8	○
1880908	11 IR 24 UN	24	6.35	11	0.7	0.8	○
1880907	11 IR 20 UN	20	6.35	11	0.8	0.9	○
1880906	11 IR 18 UN	18	6.35	11	0.8	1.0	○
1880905	11 IR 16 UN	16	6.35	11	0.9	1.1	⊗
1880904	11 IR 14 UN	14	6.35	11	0.9	1.1	⊗
1880903	11 IR 13 UN	13	6.35	11	0.8	1.0	○
1880902	11 IR 12 UN	12	6.35	11	0.9	1.1	⊗
1880901	11 IR 11 UN	11	6.35	11	0.8	1.1	○
1882126	16 IR 72 UN	72	9.525	16	0.8	0.3	○
1882124	16 IR 64 UN	64	9.525	16	0.8	0.4	○
1882123	16 IR 56 UN	56	9.525	16	0.7	0.4	○
1882122	16 IR 48 UN	48	9.525	16	0.6	0.6	○
1882121	16 IR 44 UN	44	9.525	16	0.6	0.6	○
1882120	16 IR 40 UN	40	9.525	16	0.6	0.6	○
1882118	16 IR 36 UN	36	9.525	16	0.6	0.6	○
1880900	16 IR 32 UN	32	9.525	16	0.6	0.6	○
1880899	16 IR 28 UN	28	9.525	16	0.6	0.7	○
1882117	16 IR 27 UN	27	9.525	16	0.7	0.8	○
1880898	16 IR 24 UN	24	9.525	16	0.7	0.8	○
1880618	16 IR 20 UN	20	9.525	16	0.8	0.9	⊗
1880897	16 IR 18 UN	18	9.525	16	0.8	1.0	⊗
1880037	16 IR 16 UN	16	9.525	16	0.9	1.1	○
1880034	16 IR 14 UN	14	9.525	16	1.0	1.2	○
1882116	16 IR 13 UN	13	9.525	16	1.0	1.3	○

⊗ Stock item | Produto de stock | Itens de stock

○ Available under request | Disponível sobre consulta | Disponible bajo consulta

Insert order code = (1) Geometry Code + (2) Grade Code

mm
THREADING
Thread milling - Inserts
Thread milling - Toolholders
Thread turning - Overview
Thread turning - Inserts
Thread turning - Toolholders
Thread turning - Spare Parts
Technical Data

AMERICAN UN (UNC, UNF, UNEF) | ANSI B1.1-1982

Internal

Geometry code ⁽¹⁾	Reference Referência Referencia	Pitch TPI	Dimensions Dimensões Dimensiones (mm)				Stock - Grade Code ⁽²⁾ (68) PH6920
			IC	L	X	Y	
1880894	16 IR 12 UN	12	9.525	16	1.1	1.4	⊗
1883757	16 IR 11.5 UN	11.5	9.525	16	1.1	1.5	○
1880893	16 IR 11 UN	11	9.525	16	1.1	1.5	○
1880892	16 IR 10 UN	10	9.525	16	1.1	1.5	○
1880891	16 IR 9 UN	9	9.525	16	1.2	1.7	○
1880044	16 IR 8 UN	8	9.525	16	1.2	1.6	○
1880889	22 IR 7 UN	7	12.70	22	1.6	2.3	○
1880888	22 IR 6 UN	6	12.70	22	1.6	2.3	○
1880887	22 IR 5 UN	5	12.70	22	1.6	2.3	○
1882181	27 IR 4.5 UN	4.5	15.875	27	1.7	2.4	○
1882184	27 IR 4 UN	4	15.875	27	1.8	2.7	○
1881712	06 IL 32 UN	32	4.00	06	0.8	0.5	○
1881711	06 IL 28 UN	28	4.00	06	0.8	0.6	○
1881708	06 IL 24 UN	24	4.00	06	0.7	0.6	○
1883758	06 IL 20 UN	20	4.00	06	0.6	0.6	○
1881707	06 IL 18 UN	18	4.00	06	0.6	0.7	○
1881748	08 IL 32 UN	32	5.00	08	0.6	0.5	○
1881747	08 IL 28 UN	28	5.00	08	0.6	0.6	○
1881744	08 IL 24 UN	24	5.00	08	0.6	0.6	○
1881743	08 IL 20 UN	20	5.00	08	0.6	0.7	○
1881741	08 IL 18 UN	18	5.00	08	0.6	0.7	○
1881739	08 IL 16 UN	16	5.00	08	0.6	0.7	○
1881738	08 IL 14 UN	14	5.00	08	0.6	0.8	○
1881936	11 IL 72 UN	72	6.35	11	0.8	0.3	○
1881935	11 IL 64 UN	64	6.35	11	0.8	0.4	○
1881934	11 IL 56 UN	56	6.35	11	0.7	0.4	○
1881933	11 IL 48 UN	48	6.35	11	0.6	0.6	○
1881932	11 IL 44 UN	44	6.35	11	0.6	0.6	○
1881931	11 IL 40 UN	40	6.35	11	0.6	0.6	○
1881930	11 IL 36 UN	36	6.35	11	0.6	0.6	○
1880935	11 IL 32 UN	32	6.35	11	0.6	0.6	○
1880934	11 IL 28 UN	28	6.35	11	0.6	0.7	○
1881928	11 IL 27 UN	27	6.35	11	0.7	0.8	○
1880933	11 IL 24 UN	24	6.35	11	0.7	0.8	○
1880932	11 IL 20 UN	20	6.35	11	0.8	0.9	○
1880931	11 IL 18 UN	18	6.35	11	0.8	1.0	○
1880930	11 IL 16 UN	16	6.35	11	0.9	1.1	○
1880929	11 IL 14 UN	14	6.35	11	0.9	1.1	○
1880928	11 IL 13 UN	13	6.35	11	0.8	1.0	○
1880927	11 IL 12 UN	12	6.35	11	0.9	1.1	○
1880926	11 IL 11 UN	11	6.35	11	0.8	1.1	○
1882101	16 IL 72 UN	72	9.525	16	0.8	0.3	○
1882098	16 IL 64 UN	64	9.525	16	0.8	0.4	○
1882097	16 IL 56 UN	56	9.525	16	0.7	0.4	○
1882096	16 IL 48 UN	48	9.525	16	0.6	0.6	○
1882095	16 IL 44 UN	44	9.525	16	0.6	0.6	○

⊗ Stock item | Produto de stock | Itens de stock

○ Available under request | Disponível sobre consulta | Disponible bajo consulta

Insert order code = (1) Geometry Code + (2) Grade Code

Internal

Geometry code ⁽¹⁾	Reference Referência Referencia	Pitch	Dimensions Dimensões Dimensiones (mm)				Stock - Grade Code ⁽²⁾
		TPI	IC	L	X	Y	(68) PH6920
1882094	16 IL 40 UN	40	9.525	16	0.6	0.6	○
1882092	16 IL 36 UN	36	9.525	16	0.6	0.6	○
1880925	16 IL 32 UN	32	9.525	16	0.6	0.6	○
1880924	16 IL 28 UN	28	9.525	16	0.6	0.7	○
1882089	16 IL 27 UN	27	9.525	16	0.7	0.8	○
1880923	16 IL 24 UN	24	9.525	16	0.7	0.8	○
1880922	16 IL 20 UN	20	9.525	16	0.8	0.9	○
1880921	16 IL 18 UN	18	9.525	16	0.8	1.0	○
1880920	16 IL 16 UN	16	9.525	16	0.9	1.1	○
1880919	16 IL 14 UN	14	9.525	16	1.0	1.2	○
1882074	16 IL 13 UN	13	9.525	16	1.0	1.3	○
1880918	16 IL 12 UN	12	9.525	16	1.1	1.4	○
1883759	16 IL 11.5 UN	11.5	9.525	16	1.1	1.5	○
1880917	16 IL 11 UN	11	9.525	16	1.1	1.5	○
1880916	16 IL 10 UN	10	9.525	16	1.1	1.5	○
1880915	16 IL 9 UN	9	9.525	16	1.2	1.7	○
1880914	16 IL 8 UN	8	9.525	16	1.2	1.6	○
1880913	22 IL 7 UN	7	12.70	22	1.6	2.3	○
1880912	22 IL 6 UN	6	12.70	22	1.6	2.3	○
1880911	22 IL 5 UN	5	12.70	22	1.6	2.3	○
1882170	27 IL 4.5 UN	4.5	15.875	27	1.7	2.4	○
1882173	27 IL 4 UN	4	15.875	27	1.8	2.7	○

 Stock item | Produto de stock | Itens de stock

 Available under request | Disponível sobre consulta | Disponible bajo consulta

Insert order code = (1) Geometry Code + (2) Grade Code

mm

THREADING

Thread milling - Inserts

Thread milling - Toolholders

Thread turning - Overview

Thread turning - Inserts

Thread turning - Toolholders

Thread turning - Spare Parts

Technical Data

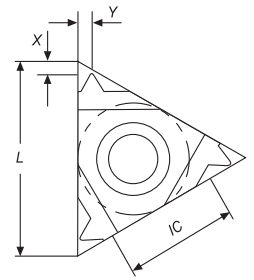
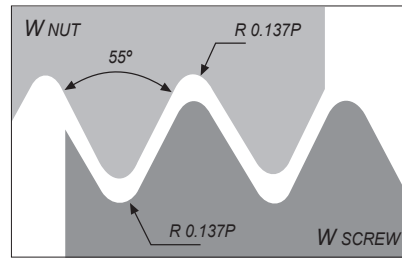
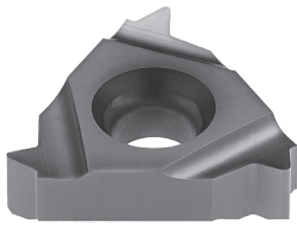

External

Geometry code ⁽¹⁾	Reference Referência Referencia	Pitch TPI	Dimensions Dimensões Dimensiones (mm)				Stock - Grade Code ⁽²⁾ (68) PH6920
			IC	L	X	Y	
1881908	11 ER 72 W	72	6.35	11	0.7	0.4	○
1881905	11 ER 60 W	60	6.35	11	0.7	0.4	○
1881904	11 ER 56 W	56	6.35	11	0.7	0.4	○
1881902	11 ER 48 W	48	6.35	11	0.6	0.6	○
1881899	11 ER 40 W	40	6.35	11	0.6	0.6	○
1881897	11 ER 36 W	36	6.35	11	0.6	0.6	○
1881895	11 ER 32 W	32	6.35	11	0.6	0.6	○
1881893	11ER 28 W	28	6.35	11	0.6	0.7	○
1881887	11 ER 26 W	26	6.35	11	0.7	0.7	○
1881886	11 ER 24 W	24	6.35	11	0.7	0.8	○
1881884	11 ER 22 W	22	6.35	11	0.8	0.9	○
1881883	11 ER 20 W	20	6.35	11	0.8	0.9	○
1881880	11 ER 19 W	19	6.35	11	0.8	1.0	○
1881878	11 ER 18 W	18	6.35	11	0.8	1.0	○
1881874	11 ER 16 W	16	6.35	11	0.9	1.1	○
1881870	11 ER 14 W	14	6.35	11	0.9	1.1	○
1882056	16 ER 72 W	72	9.525	16	0.7	0.4	○
1882053	16 ER 60 W	60	9.525	16	0.7	0.4	○
1882052	16 ER 56 W	56	9.525	16	0.7	0.4	○
1882050	16 ER 48 W	48	9.525	16	0.6	0.6	○
1882047	16 ER 40 W	40	9.525	16	0.6	0.6	○
1882045	16 ER 36 W	36	9.525	16	0.6	0.6	○
1882043	16 ER 32 W	32	9.525	16	0.6	0.6	○
1880940	16 ER 28 W	28	9.525	16	0.6	0.7	○
1882040	16 ER 26 W	26	9.525	16	0.7	0.7	○
1880939	16 ER 24 W	24	9.525	16	0.7	0.8	○
1882039	16 ER 22 W	22	9.525	16	0.8	0.9	○
1880938	16 ER 20 W	20	9.525	16	0.8	0.9	⊗
1880017	16 ER 19 W	19	9.525	16	0.8	1.0	⊗
1880937	16 ER 18 W	18	9.525	16	0.8	1.0	○
1880609	16 ER 16 W	16	9.525	16	0.9	1.1	⊗
1880015	16 ER 14 W	14	9.525	16	1.0	1.2	⊗
1880611	16 ER 12 W	12	9.525	16	1.1	1.4	⊗
1880613	16 ER 11 W	11	9.525	16	1.1	1.5	⊗
1880614	16 ER 10 W	10	9.525	16	1.1	1.5	⊗
1880936	16 ER 9 W	9	9.525	16	1.2	1.7	○

⊗ Stock item | Produto de stock | Itens de stock

○ Available under request | Disponível sobre consulta | Disponible bajo consulta

Insert order code = (1) Geometry Code + (2) Grade Code

External

Geometry code ⁽¹⁾	Reference Referência Referencia	Pitch	Dimensions Dimensões Dimensiones (mm)				Stock - Grade Code ⁽²⁾
		TPI	IC	L	X	Y	(68) PH6920
1880646	16 ER 8 W	8	9.525	16	1.2	1.5	⊗
1880941	22 ER 7 W	7	12.70	22	1.6	2.3	⊗
1880942	22 ER 6 W	6	12.70	22	1.6	2.3	○
1880943	22 ER 5 W	5	12.70	22	1.7	2.4	○
1882158	27 ER 4.5 W	4.5	15.875	27	1.8	2.6	○
1882162	27 ER 4 W	4	15.875	27	2.0	2.9	○
1881849	11 EL 72 W	72	6.35	11	0.7	0.4	○
1881846	11 EL 60 W	60	6.35	11	0.7	0.4	○
1881845	11 EL 56 W	56	6.35	11	0.7	0.4	○
1881844	11 EL 48 W	48	6.35	11	0.6	0.6	○
1881841	11 EL 40 W	40	6.35	11	0.6	0.6	○
1881839	11 EL 36 W	36	6.35	11	0.6	0.6	○
1881837	11 EL 32 W	32	6.35	11	0.6	0.6	○
1881835	11 EL 28 W	28	6.35	11	0.6	0.7	○
1881829	11 EL 26 W	26	6.35	11	0.7	0.7	○
1881828	11 EL 24 W	24	6.35	11	0.7	0.8	○
1881826	11 EL 22 W	22	6.35	11	0.8	0.9	○
1881825	11 EL 20 W	20	6.35	11	0.8	0.9	○
1881822	11 EL 19 W	19	6.35	11	0.8	1.0	○
1881820	11 EL 18 W	18	6.35	11	0.8	1.0	○
1881816	11 EL 16 W	16	6.35	11	0.9	1.1	○
1881812	11 EL 14 W	14	6.35	11	0.9	1.1	○
1882023	16 EL 72 W	72	9.525	16	0.7	0.4	○
1882019	16 EL 60 W	60	9.525	16	0.7	0.4	○
1882018	16 EL 56 W	56	9.525	16	0.7	0.4	○
1882016	16 EL 48 W	48	9.525	16	0.6	0.6	○
1882013	16 EL 40 W	40	9.525	16	0.6	0.6	○
1882011	16 EL 36 W	36	9.525	16	0.6	0.6	○
1882009	16 EL 32 W	32	9.525	16	0.6	0.6	○
1880955	16 EL 28 W	28	9.525	16	0.6	0.7	○
1882004	16 EL 26 W	26	9.525	16	0.6	0.7	○
1880954	16 EL 24 W	24	9.525	16	0.7	0.8	○
1882003	16 EL 22 W	22	9.525	16	0.8	0.9	○
1880953	16 EL 20 W	20	9.525	16	0.8	0.9	○
1880952	16 EL 19 W	19	9.525	16	0.8	1.0	○
1880951	16 EL 18 W	18	9.525	16	0.8	1.0	○
1880950	16 EL 16 W	16	9.525	16	0.9	1.1	○
1880949	16 EL 14 W	14	9.525	16	1.0	1.2	⊗
1880948	16 EL 12 W	12	9.525	16	1.1	1.4	○
1880947	16 EL 11 W	11	9.525	16	1.1	1.5	○
1880946	16 EL 10 W	10	9.525	16	1.1	1.5	○
1880945	16 EL 9 W	9	9.525	16	1.2	1.7	○
1880944	16 EL 8 W	8	9.525	16	1.2	1.5	○
1880956	22 EL 7 W	7	12.70	22	1.6	2.3	○
1880957	22 EL 6 W	6	12.70	22	1.6	2.3	○
1880958	22 EL 5 W	5	12.70	22	1.7	2.4	○
1882145	27 EL 4.5 W	4.5	15.875	27	1.8	2.6	○
1882149	27 EL 4 W	4	15.875	27	2.0	2.9	○

⊗ Stock item | Produto de stock | Itens de stock

○ Available under request | Disponível sobre consulta | Disponible bajo consulta

Insert order code = (1) Geometry Code + (2) Grade Code

WITHWORTH FOR BSW, BSF, BSP, B.S.84: 1956, DIN 259, ISO 228-1:1994

Internal

Geometry code ⁽¹⁾	Reference Referência Referencia	Pitch	Dimensions Dimensões Dimensiones (mm)				Stock - Grade Code ⁽²⁾
		TPI	IC	L	X	Y	(68) PH6920
1882203	06 IR 26 W	26	4.00	06	0.7	0.6	○
1882207	06 IR 22 W	22	4.00	06	0.6	0.6	○
1883760	06 IR 20 W	20	4.00	06	0.6	0.7	○
1882211	06 IR 18 W	18	4.00	06	0.6	0.7	○
1882213	08 IR 28 W	28	5.00	08	0.6	0.6	○
1882217	08 IR 24 W	24	5.00	08	0.6	0.6	○
1882219	08 IR 20 W	20	5.00	08	0.6	0.7	○
1882221	08 IR 19 W	19	5.00	08	0.6	0.7	○
1882223	08 IR 18 W	18	5.00	08	0.6	0.7	○
1882225	08 IR 16 W	16	5.00	08	0.6	0.7	○
1882227	11 IR 72 W	72	6.35	11	0.7	0.4	○
1882229	11 IR 60 W	60	6.35	11	0.7	0.4	○
1882231	11 IR 56 W	56	6.35	11	0.7	0.4	○
1882233	11 IR 48 W	48	6.35	11	0.6	0.6	○
1882235	11 IR 40 W	40	6.35	11	0.6	0.6	○
1883761	11 IR 36 W	36	6.35	11	0.6	0.6	○
1882237	11 IR 32 W	32	6.35	11	0.6	0.6	○
1880972	11 IR 28 W	28	6.35	11	0.6	0.7	○
1882239	11 IR 26 W	26	6.35	11	0.7	0.7	○
1880971	11 IR 24 W	24	6.35	11	0.7	0.8	○
1883762	11 IR 22 W	22	6.35	11	0.8	0.9	○
1880970	11 IR 20 W	20	6.35	11	0.8	0.9	○
1880005	11 IR 19 W	19	6.35	11	0.8	1.0	○
1880968	11 IR 18 W	18	6.35	11	0.8	1.0	⊗
1880967	11 IR 16 W	16	6.35	11	0.9	1.1	○
1880004	11 IR 14 W	14	6.35	11	0.9	1.1	⊗
1883763	11 IR 12 W	12	6.35	11	1.0	1.1	○
1883764	11 IR 11 W	11	6.35	11	0.9	1.2	○
1882241	16 IR 72 W	72	9.525	16	0.7	0.4	○
1882498	16 IR 60 W	60	9.525	16	0.7	0.4	○
1882244	16 IR 56 W	56	9.525	16	0.7	0.4	○
1882246	16 IR 48 W	48	9.525	16	0.6	0.6	○
1882248	16 IR 40 W	40	9.525	16	0.6	0.6	○
1882250	16 IR 36 W	36	9.525	16	0.6	0.6	○
1882252	16 IR 32 W	32	9.525	16	0.6	0.6	○
1880965	16 IR 28 W	28	9.525	16	0.6	0.7	○
1882254	16 IR 26 W	26	9.525	16	0.6	0.7	○
1880964	16 IR 24 W	24	9.525	16	0.7	0.8	○
1882256	16 IR 22 W	22	9.525	16	0.8	0.9	○
1880963	16 IR 20 W	20	9.525	16	0.8	0.9	⊗
1880608	16 IR 19 W	19	9.525	16	0.8	1.0	⊗
1880962	16 IR 18 W	18	9.525	16	0.8	1.0	○
1880610	16 IR 16 W	16	9.525	16	0.9	1.1	○
1880035	16 IR 14 W	14	9.525	16	1.0	1.2	⊗
1880612	16 IR 12 W	12	9.525	16	1.1	1.4	⊗
1880031	16 IR 11 W	11	9.525	16	1.1	1.5	⊗

⊗ Stock item | Produto de stock | Itens de stock

○ Available under request | Disponível sobre consulta | Disponible bajo consulta

Insert order code = (1) Geometry Code + (2) Grade Code

Internal

Geometry code ⁽¹⁾	Reference Referência Referencia	Pitch	Dimensions Dimensões Dimensiones (mm)				Stock - Grade Code ⁽²⁾
		TPI	IC	L	X	Y	(68) PH6920
1880615	16 IR 10 W	10	9.525	16	1.1	1.5	○
1882258	16 IR 9 W	9	9.525	16	1.2	1.7	○
1880672	16 IR 8 W	8	9.525	16	1.2	1.5	⊗
1880959	22 IR 7 W	7	12.70	22	1.6	2.3	○
1880960	22 IR 6 W	6	12.70	22	1.6	2.3	○
1880961	22 IR 5 W	5	12.70	22	1.7	2.4	○
1882259	27 IR 4.5 W	4.5	15.875	27	1.8	2.6	○
1882261	27 IR 4 W	4	15.875	27	2.0	2.9	○
1882204	06 IL 26 W	26	4.00	06	0.7	0.6	○
1882208	06 IL 22 W	22	4.00	06	0.6	0.6	○
1883765	06 IL 20 W	20	4.00	06	0.6	0.7	○
1882212	06 IL 18 W	18	4.00	06	0.6	0.7	○
1882214	08 IL 28 W	28	5.00	08	0.7	0.7	○
1882218	08 IL 24 W	24	5.00	08	0.7	0.7	○
1882220	08 IL 20 W	20	5.00	08	0.7	0.7	○
1882222	08 IL 19 W	19	5.00	08	0.7	0.7	○
1882224	08 IL 18 W	18	5.00	08	0.7	0.7	○
1882226	08 IL 16 W	16	5.00	08	0.7	0.7	○
1882228	11 IL 72 W	72	6.35	11	0.7	0.4	○
1882230	11 IL 60 W	60	6.35	11	0.7	0.4	○
1882232	11 IL 56 W	56	6.35	11	0.7	0.4	○
1882234	11 IL 48 W	48	6.35	11	0.6	0.6	○
1882236	11 IL 40 W	40	6.35	11	0.6	0.6	○
1883766	11 IL 36 W	36	6.35	11	0.6	0.6	○
1882238	11 IL 32 W	32	6.35	11	0.6	0.6	○
1880994	11 IL 28 W	28	6.35	11	0.6	0.7	○
1882240	11 IL 26 W	26	6.35	11	0.7	0.7	○
1880993	11 IL 24 W	24	6.35	11	0.7	0.8	○
1883767	11 IL 22 W	22	6.35	11	0.8	0.9	○
1880992	11 IL 20 W	20	6.35	11	0.8	0.9	○
1880991	11 IL 19 W	19	6.35	11	0.8	1.0	○
1880990	11 IL 18 W	18	6.35	11	0.8	1.0	○
1880989	11 IL 16 W	16	6.35	11	0.9	1.1	○
1880988	11 IL 14 W	14	6.35	11	0.9	1.1	○
1883768	11 IL 12 W	12	6.35	11	1.0	1.1	○
1883769	11 IL 11 W	11	6.35	11	0.9	1.2	○
1882242	16 IL 72 W	72	9.525	16	0.7	0.4	○
1882243	16 IL 60 W	60	9.525	16	0.7	0.4	○
1882245	16 IL 56 W	56	9.525	16	0.7	0.4	○
1882247	16 IL 48 W	48	9.525	16	0.6	0.6	○

⊗ Stock item | Produto de stock | Itens de stock

○ Available under request | Disponível sobre consulta | Disponible bajo consulta

Insert order code = (1) Geometry Code + (2) Grade Code

WITHWORTH FOR BSW, BSF, BSP, B.S.84: 1956, DIN 259, ISO 228-1:1994

Internal

Geometry code ⁽¹⁾	Reference Referência Referencia	Pitch	Dimensions Dimensões Dimensiones (mm)				Stock - Grade Code ⁽²⁾
		TPI	IC	L	X	Y	(68) PH6920
1882249	16 IL 40 W	40	9.525	16	0.6	0.6	○
1882251	16 IL 36 W	36	9.525	16	0.6	0.6	○
1882253	16 IL 32 W	32	9.525	16	0.6	0.6	○
1880987	16 IL 28 W	28	9.525	16	0.6	0.7	○
1882255	16 IL 26 W	26	9.525	16	0.6	0.7	○
1880986	16 IL 24 W	24	9.525	16	0.7	0.8	○
1882257	16 IL 22 W	22	9.525	16	0.8	0.9	○
1880985	16 IL 20 W	20	9.525	16	0.8	0.9	○
1880984	16 IL 19 W	19	9.525	16	0.8	1.0	○
1880983	16 IL 18 W	18	9.525	16	0.8	1.0	○
1880982	16 IL 16 W	16	9.525	16	0.9	1.1	○
1880981	16 IL 14 W	14	9.525	16	1.0	1.2	○
1880980	16 IL 12 W	12	9.525	16	1.1	1.4	○
1880979	16 IL 11 W	11	9.525	16	1.1	1.5	⊗
1880978	16 IL 10 W	10	9.525	16	1.1	1.5	○
1880977	16 IL 9 W	9	9.525	16	1.2	1.7	○
1880976	16 IL 8 W	8	9.525	16	1.2	1.5	○
1880975	22 IL 7 W	7	12.70	22	1.6	2.3	○
1880974	22 IL 6 W	6	12.70	22	1.6	2.3	○
1880973	22 IL 5 W	5	12.70	22	1.7	2.4	○
1882260	27 IL 4.5 W	4.5	15.875	27	1.8	2.6	○
1882262	27 IL 4 W	4	15.875	27	2.0	2.9	○

⊗ Stock item | Produto de stock | Itens de stock

○ Available under request | Disponível sobre consulta | Disponible bajo consulta

Insert order code = (1) Geometry Code + (2) Grade Code

mm

THREADING

Thread milling - Inserts

Thread milling - Toolholders

Thread turning - Overview

Thread turning - Inserts

Thread turning - Toolholders

Thread turning - Spare Parts

Technical Data

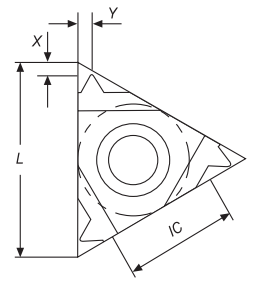
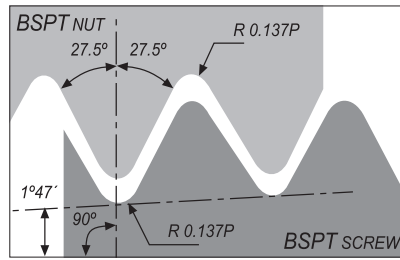
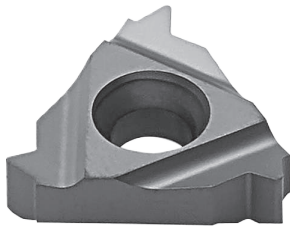

External

Geometry code ⁽¹⁾	Reference Referência Referencia	Pitch TPI	Dimensions Dimensões Dimensiones (mm)				Stock - Grade Code ⁽²⁾ (68) PH6920
			IC	L	X	Y	
1880998	16 ER 28 BSPT	28	9.525	16	0.6	0.6	○
1880997	16 ER 19 BSPT	19	9.525	16	0.8	0.9	○
1880996	16 ER 14 BSPT	14	9.525	16	1.0	1.2	○
1880995	16 ER 11 BSPT	11	9.525	16	1.1	1.5	⊗
1882008	16 EL 28 BSPT	28	9.525	16	0.6	0.6	○
1882001	16 EL 19 BSPT	19	9.525	16	0.8	0.9	○
1881993	16 EL 14 BSPT	14	9.525	16	1.0	1.2	○
1881989	16 EL 11 BSPT	11	9.525	16	1.1	1.5	○

⊗ Stock item | Produto de stock | Itens de stock

○ Available under request | Disponível sobre consulta | Disponible bajo consulta

Insert order code = (1) Geometry Code + (2) Grade Code

Internal

Geometry code ⁽¹⁾	Reference Referência Referencia	Pitch TPI	Dimensions Dimensões Dimensiones (mm)				Stock - Grade Code ⁽²⁾ (68) PH6920
			IC	L	X	Y	
1881724	06 IR 28 BSPT	28	4.00	06	0.7	0.6	○
1881767	08 IR 28 BSPT	28	5.00	08	0.6	0.6	○
1881763	08 IR 19 BSPT	19	5.00	08	0.6	0.6	○
1881949	11 IR 28 BSPT	28	6.35	11	0.6	0.6	○
1881004	11 IR 19 BSPT	19	6.35	11	0.8	0.9	○
1881003	11 IR 14 BSPT	14	6.35	11	0.9	1.0	○
1883770	11 IR 11 BSPT	11	6.35	11	0.9	1.2	○
1881002	16 IR 28 BSPT	28	9.525	16	0.6	0.6	○
1881001	16 IR 19 BSPT	19	9.525	16	0.8	0.9	○
1881000	16 IR 14 BSPT	14	9.525	16	1.0	1.2	○
1880999	16 IR 11 BSPT	11	9.525	16	1.1	1.5	○
1881710	06 IL 28 BSPT	28	4.00	06	0.7	0.6	○
1881746	08 IL 28 BSPT	28	5.00	08	0.6	0.6	○
1881742	08 IL 19 BSPT	19	5.00	08	0.6	0.6	○
1881929	11 IL 28 BSPT	28	6.35	11	0.6	0.6	○
1881925	11 IL 19 BSPT	19	6.35	11	0.8	0.9	○
1881918	11 IL 14 BSPT	14	6.35	11	0.9	1.0	○
1883771	11 IL 11 BSPT	11	6.35	11	0.9	1.2	○
1882090	16 IL 28 BSPT	28	9.525	16	0.6	0.6	○
1882084	16 IL 19 BSPT	19	9.525	16	0.8	0.9	○
1882076	16 IL 14 BSPT	14	9.525	16	1.0	1.2	○
1882071	16 IL 11 BSPT	11	9.525	16	1.1	1.5	○

⊗ Stock item | Produto de stock | Itens de stock

○ Available under request | Disponível sobre consulta | Disponible bajo consulta

Insert order code = (1) Geometry Code + (2) Grade Code

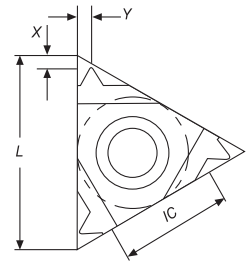
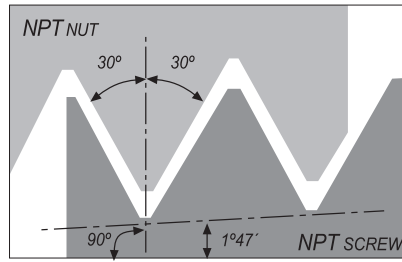
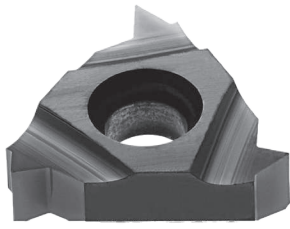

External

Geometry code ⁽¹⁾	Reference Referência Referencia	Pitch TPI	Dimensions Dimensões Dimensiones (mm)				Stock - Grade Code ⁽²⁾ (68) PH6920
			IC	L	X	Y	
1881888	11 ER 27 NPT	27	6.35	11	0.7	0.8	○
1881875	11 ER 18 NPT	18	6.35	11	0.8	1.0	○
1881867	11 ER 14 NPT	14	6.35	11	0.8	1.0	○
1881017	16 ER 27 NPT	27	9.525	16	0.7	0.8	⊗
1881016	16 ER 18 NPT	18	9.525	16	0.8	1.0	⊗
1880013	16 ER 14 NPT	14	9.525	16	0.9	1.2	⊗
1880009	16 ER 11.5 NPT	11.5	9.525	16	1.1	1.5	⊗
1880023	16 ER 8 NPT	8	9.525	16	1.3	1.8	○
1881830	11 EL 27 NPT	27	6.35	11	0.7	0.8	○
1881817	11 EL 18 NPT	18	6.35	11	0.8	1.0	○
1881809	11 EL 14 NPT	14	6.35	11	0.8	1.0	○
1882005	16 EL 27 NPT	27	9.525	16	0.7	0.8	○
1881999	16 EL 18 NPT	18	9.525	16	0.8	1.0	○
1881994	16 EL 14 NPT	14	9.525	16	0.9	1.2	○
1881987	16 EL 11.5 NPT	11.5	9.525	16	1.1	1.5	○
1882025	16 EL 8 NPT	8	9.525	16	1.3	1.8	○

⊗ Stock item | Produto de stock | Itens de stock

○ Available under request | Disponível sobre consulta | Disponible bajo consulta

Insert order code = (1) Geometry Code + (2) Grade Code

Internal

Geometry code ⁽¹⁾	Reference Referência Referencia	Pitch	Dimensions Dimensões Dimensiones (mm)				Stock - Grade Code ⁽²⁾
		TPI	IC	L	X	Y	(68) PH6920
1881723	06 IR 27 NPT	27	4.00	06	0.6	0.6	○
1881766	08 IR 27 NPT	27	5.00	08	0.6	0.6	○
1881761	08 IR 18 NPT	18	5.00	08	0.6	0.6	○
1881946	11 IR 27 NPT	27	6.35	11	0.7	0.8	○
1881020	11 IR 18 NPT	18	6.35	11	0.8	1.0	⊗
1880003	11 IR 14 NPT	14	6.35	11	0.8	1.0	⊗
1881019	16 IR 27 NPT	27	9.525	16	0.7	0.8	○
1881018	16 IR 18 NPT	18	9.525	16	0.8	1.0	⊗
1880033	16 IR 14 NPT	14	9.525	16	0.9	1.2	⊗
1880029	16 IR 11.5 NPT	11.5	9.525	16	1.1	1.5	○
1880043	16 IR 8 NPT	8	9.525	16	1.3	1.8	○
1881709	06 IL 27 NPT	27	4.00	06	0.6	0.6	○
1881745	08 IL 27 NPT	27	5.00	08	0.6	0.6	○
1881740	08 IL 18 NPT	18	5.00	08	0.6	0.6	○
1881926	11 IL 27 NPT	27	6.35	11	0.7	0.8	○
1881923	11 IL 18 NPT	18	6.35	11	0.8	1.0	○
1881919	11 IL 14 NPT	14	6.35	11	0.8	1.0	○
1882087	16 IL 27 NPT	27	9.525	16	0.7	0.8	○
1882082	16 IL 18 NPT	18	9.525	16	0.8	1.0	○
1882077	16 IL 14 NPT	14	9.525	16	0.9	1.2	○
1882069	16 IL 11.5 NPT	11.5	9.525	16	1.1	1.5	○
1882103	16 IL 8 NPT	8	9.525	16	1.3	1.8	○

⊗ Stock item | Produto de stock | Itens de stock

○ Available under request | Disponível sobre consulta | Disponible bajo consulta

Insert order code = (1) Geometry Code + (2) Grade Code

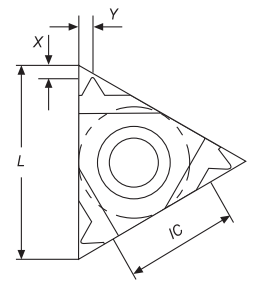
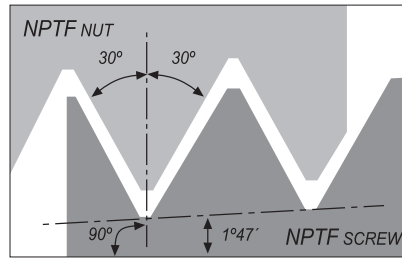
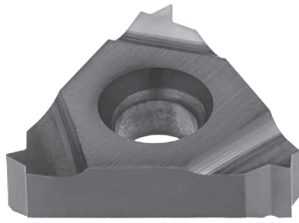

External

Geometry code ⁽¹⁾	Reference Referência Referencia	Pitch TPI	Dimensions Dimensões Dimensiones (mm)				Stock - Grade Code ⁽²⁾ (68) PH6920
			IC	L	X	Y	
1881889	11 ER 27 NPTF	27	6.35	11	0.7	0.7	○
1881876	11 ER 18 NPTF	18	6.35	11	0.8	1.0	○
1881868	11 ER 14 NPTF	14	6.35	11	0.8	1.0	○
1881030	16 ER 27 NPTF	27	9.525	16	0.7	0.7	⊗
1881029	16 ER 18 NPTF	18	9.525	16	0.8	1.0	⊗
1881028	16 ER 14 NPTF	14	9.525	16	0.9	1.2	○
1881027	16 ER 11.5 NPTF	11.5	9.525	16	1.1	1.5	○
1882057	16 ER 8 NPTF	8	9.525	16	1.3	1.8	○
1881831	11 EL 27 NPTF	27	6.35	11	0.7	0.7	○
1881818	11 EL 18 NPTF	18	6.35	11	0.8	1.0	○
1881810	11 EL 14 NPTF	14	6.35	11	0.8	1.0	○
1882006	16 EL 27 NPTF	27	9.525	16	0.7	0.8	○
1882000	16 EL 18 NPTF	18	9.525	16	0.8	1.0	○
1881995	16 EL 14 NPTF	14	9.525	16	0.9	1.2	○
1881988	16 EL 11.5 NPTF	11.5	9.525	16	1.1	1.5	○
1882026	16 EL 8 NPTF	8	9.525	16	1.3	1.8	○

⊗ Stock item | Produto de stock | Itens de stock

○ Available under request | Disponível sobre consulta | Disponible bajo consulta

Insert order code = (1) Geometry Code + (2) Grade Code

Internal

Geometry code ⁽¹⁾	Reference Referência Referencia	Pitch	Dimensions Dimensões Dimensiones (mm)				Stock - Grade Code ⁽²⁾
		TPI	IC	L	X	Y	(68) PH6920
1883772	06 IR 27 NPTF	27	4.00	06	0.7	0.6	○
1883773	08 IR 18 NPTF	18	5.00	08	0.6	0.6	○
1883774	08 IR 14 NPTF	14	5.00	08	0.6	0.6	○
1881947	11 IR 27 NPTF	27	6.35	11	0.7	0.7	○
1881026	11 IR 18 NPTF	18	6.35	11	0.8	1.0	○
1881025	11 IR 14 NPTF	14	6.35	11	0.8	1.0	○
1881024	16 IR 27 NPTF	27	9.525	16	0.7	0.7	○
1881023	16 IR 18 NPTF	18	9.525	16	0.8	1.0	○
1881022	16 IR 14 NPTF	14	9.525	16	0.9	1.2	○
1881021	16 IR 11.5 NPTF	11.5	9.525	16	1.1	1.5	○
1882127	16 IR 8 NPTF	8	9.525	16	1.3	1.8	○
1883775	06 IL 27 NPTF	27	4.00	06	0.7	0.6	○
1883776	08 IL 18 NPTF	18	5.00	08	0.6	0.6	○
1883777	08 IL 14 NPTF	14	5.00	08	0.6	0.6	○
1881927	11 IL 27 NPTF	27	6.35	11	0.7	0.7	○
1881924	11 IL 18 NPTF	18	6.35	11	0.8	1.0	○
1881920	11 IL 14 NPTF	14	6.35	11	0.8	1.0	○
1882088	16 IL 27 NPTF	27	9.525	16	0.7	0.7	○
1882083	16 IL 18 NPTF	18	9.525	16	0.8	1.0	○
1882078	16 IL 14 NPTF	14	9.525	16	0.9	1.2	○
1882070	16 IL 11.5 NPTF	11.5	9.525	16	1.1	1.5	○
1882104	16 IL 8 NPTF	8	9.525	16	1.3	1.8	○

Stock item | Produto de stock | Itens de stock

Available under request | Disponível sobre consulta | Disponible bajo consulta

Insert order code = (1) Geometry Code + (2) Grade Code

ROUND (DIN 405) | DIN 405:1997

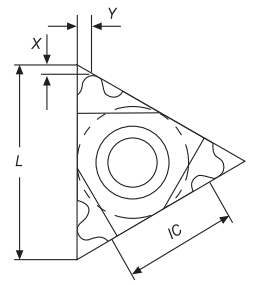
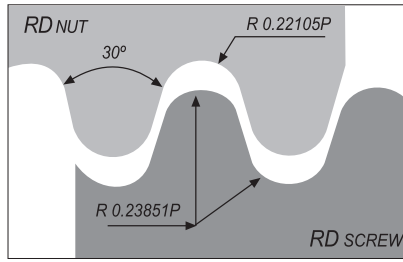
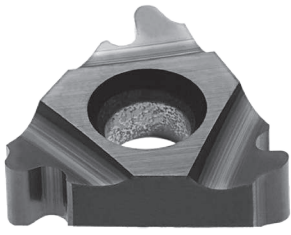

External

Geometry code ⁽¹⁾	Reference Referência Referencia	Pitch TPI	Dimensions Dimensões Dimensiones (mm)				Stock - Grade Code ⁽²⁾ (68) PH6920
			IC	L	X	Y	
1881031	16 ER 10 RD	10	9.525	16	1.1	1.2	○
1881032	16 ER 8 RD	8	9.525	16	1.4	1.4	○
1881033	16 ER 6 RD	6	9.525	16	1.4	1.5	○
1881034	22 ER 6 RD	6	12.70	22	1.5	1.7	○
1881035	22 ER 4 RD	4	12.70	22	2.2	2.3	○
1882332	27 ER 4 RD	4	15.875	27	2.2	2.3	○
1882333	16 EL 10 RD	10	9.525	16	1.1	1.2	○
1882334	16 EL 8 RD	8	9.525	16	1.4	1.4	○
1882335	16 EL 6 RD	6	9.525	16	1.4	1.5	○
1882336	22 EL 6 RD	6	12.70	22	1.5	1.7	○
1882337	22 EL 4 RD	4	12.70	22	2.2	2.3	○
1882338	27 EL 4 RD	4	15.875	27	2.2	2.3	○

☒ Stock item | Produto de stock | Itens de stock

○ Available under request | Disponível sobre consulta | Disponible bajo consulta

Insert order code = (1) Geometry Code + (2) Grade Code

Internal

Geometry code ⁽¹⁾	Reference Referência Referencia	Pitch TPI	Dimensions Dimensões Dimensiones (mm)				Stock - Grade Code ⁽²⁾ (68) PH6920
			IC	L	X	Y	
1881039	16 IR 10 RD	10	9.525	16	1.1	1.2	☒
1881040	16 IR 8 RD	8	9.525	16	1.4	1.4	☒
1881041	16 IR 6 RD	6	9.525	16	1.4	1.5	○
1881042	22 IR 6 RD	6	12.70	22	1.5	1.7	○
1881043	22 IR 4 RD	4	12.70	22	2.2	2.3	○
1882339	27 IR 4 RD	4	15.875	27	2.2	2.3	○
1882340	16 IL 10 RD	10	9.525	16	1.1	1.2	○
1882341	16 IL 8 RD	8	9.525	16	1.4	1.4	○
1882342	16 IL 6 RD	6	9.525	16	1.4	1.5	○
1882343	22 IL 6 RD	6	12.70	22	1.5	1.7	○
1882344	22 IL 4 RD	4	12.70	22	2.2	2.3	○
1882345	27 IL 4 RD	4	15.875	27	2.2	2.3	○

☒ Stock item | Produto de stock | Itens de stock

○ Available under request | Disponível sobre consulta | Disponible bajo consulta

Insert order code = (1) Geometry Code + (2) Grade Code

ROUND (DIN 20400) | DIN 20400:1990

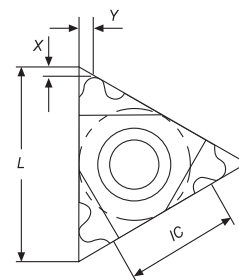
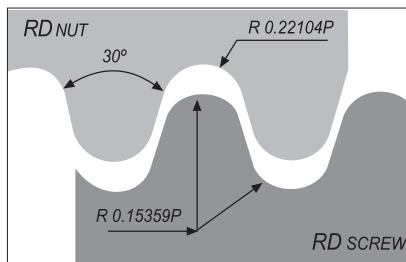
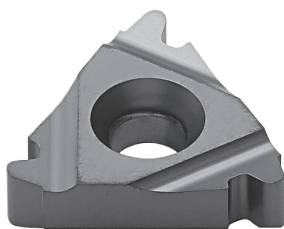

External

Geometry code ⁽¹⁾	Reference Referência Referencia	Pitch	Dimensions Dimensões Dimensiones (mm)				Stock - Grade Code ⁽²⁾
		MM	IC	L	X	Y	(68) PH6920
1882347	22 ER 4.0 RD20400	4.0	12.70	22	1.4	1.4	⊗
1882348	22 ER 5.0 RD20400	5.0	12.70	22	1.7	1.8	○
1882349	22 ER 6.0 RD20400	6.0	12.70	22	1.7	2.0	○
1882351	22 EL 4.0 RD20400	4.0	12.70	22	1.4	1.4	○
1882352	22 EL 5.0 RD20400	5.0	12.70	22	1.7	1.8	○
1882353	22 EL 6.0 RD20400	6.0	12.70	22	1.7	2.0	○

⊗ Stock item | Produto de stock | Itens de stock

○ Available under request | Disponível sobre consulta | Disponible bajo consulta

Insert order code = (1) Geometry Code + (2) Grade Code

Internal

Geometry code ⁽¹⁾	Reference Referência Referencia	Pitch	Dimensions Dimensões Dimensiones (mm)				Stock - Grade Code ⁽²⁾
		MM	IC	L	X	Y	(68) PH6920
1882355	22 IR 4.0 RD20400	4.0	12.70	22	1.4	1.4	○
1882356	22 IR 5.0 RD20400	5.0	12.70	22	1.7	1.8	○
1882357	22 IR 6.0 RD20400	6.0	12.70	22	1.7	2.0	○
1882359	22 IL 4.0 RD20400	4.0	12.70	22	1.4	1.4	○
1882360	22 IL 5.0 RD20400	5.0	12.70	22	1.7	1.8	○
1882361	22 IL 6.0 RD20400	6.0	12.70	22	1.7	2.0	○

⊗ Stock item | Produto de stock | Itens de stock

○ Available under request | Disponível sobre consulta | Disponible bajo consulta

Insert order code = (1) Geometry Code + (2) Grade Code

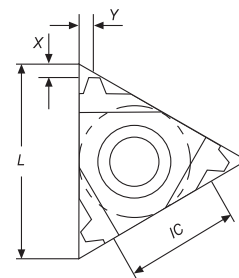
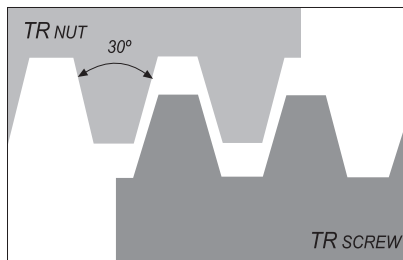
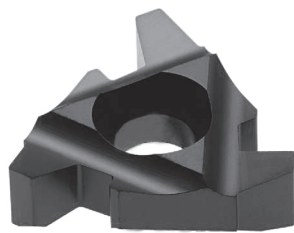

External

Geometry code ⁽¹⁾	Reference Referência Referencia	Pitch MM	Dimensions Dimensões Dimensiones (mm)				Stock - Grade Code ⁽²⁾ (68) PH6920
			IC	L	X	Y	
1881044	16 ER 1.5 TR	1.5	9.525	16	1.0	1.1	○
1881045	16 ER 2.0 TR	2.0	9.525	16	1.0	1.3	⊗
1881046	16 ER 3.0 TR	3.0	9.525	16	1.3	1.5	⊗
1883778	16 ER 4.0 TR	4.0	9.525	16	1.3	1.5	○
1881047	22 ER 4.0 TR	4.0	12.70	22	1.8	1.9	⊗
1881049	22 ER 5.0 TR	5.0	12.70	22	2.0	2.4	⊗
1883779	22 ER 6.0 TR	6.0	12.70	22	2.0	2.4	○
1882165	27 ER 6.0 TR	6.0	15.875	27	2.3	2.7	○
1882166	27 ER 7.0 TR	7.0	15.875	27	2.2	2.6	○
1881050	16 EL 1.5 TR	1.5	9.525	16	1.0	1.1	○
1881051	16 EL 2.0 TR	2.0	9.525	16	1.1	1.3	○
1881052	16 EL 3.0 TR	3.0	9.525	16	1.3	1.5	○
1883780	16 EL 4.0 TR	4.0	9.525	16	1.3	1.5	○
1881053	22 EL 4.0 TR	4.0	12.70	22	1.8	1.9	○
1882130	22 EL 5.0 TR	5.0	12.70	22	2.0	2.4	○
1883781	22 EL 6.0 TR	6.0	12.70	22	2.0	2.4	○
1882152	27 EL 6.0 TR	6.0	15.875	27	2.3	2.7	○
1882153	27 EL 7.0 TR	7.0	15.875	27	2.2	2.6	○

⊗ Stock item | Produto de stock | Itens de stock

○ Available under request | Disponível sobre consulta | Disponible bajo consulta

Insert order code = (1) Geometry Code + (2) Grade Code

Internal

Geometry code ⁽¹⁾	Reference Referência Referencia	Pitch	Dimensions Dimensões Dimensiones (mm)				Stock - Grade Code ⁽²⁾
		MM	IC	L	X	Y	(68) PH6920
1883782	08 IR 1.5 TR	1.5	5.00	08	0.6	0.6	○
1881055	16 IR 1.5 TR	1.5	9.525	16	1.0	1.1	○
1881056	16 IR 2.0 TR	2.0	9.525	16	1.0	1.3	○
1881057	16 IR 3.0 TR	3.0	9.525	16	1.3	1.5	⊗
1882119	16 IR 4.0 TR	4.0	9.525	16	1.3	1.5	⊗
1881058	22 IR 4.0 TR	4.0	12.70	22	1.8	1.9	○
1881059	22 IR 5.0 TR	5.0	12.70	22	2.0	2.4	⊗
1881060	22 IR 6.0 TR	6.0	12.70	22	2.0	2.4	⊗
1882187	27 IR 6.0 TR	6.0	15.875	27	2.3	2.7	○
1882188	27 IR 7.0 TR	7.0	15.875	27	2.2	2.6	○
1883783	08 IL 1.5 TR	1.5	5.00	08	0.6	0.6	○
1881062	16 IL 2.0 TR	2.0	9.525	16	1.0	1.3	○
1881063	16 IL 3.0 TR	3.0	9.525	16	1.3	1.5	○
1882093	16 IL 4.0 TR	4.0	9.525	16	1.3	1.5	○
1881064	22 IL 4.0 TR	4.0	12.70	22	1.8	1.9	○
1881065	22 IL 5.0 TR	5.0	12.70	22	2.0	2.4	○
1881066	22 IL 6.0 TR	6.0	12.70	22	2.0	2.4	○
1882176	27 IL 6.0 TR	6.0	15.875	27	2.3	2.7	○
1882177	27 IL 7.0 TR	7.0	15.875	27	2.2	2.6	○

⊗ Stock item | Produto de stock | Itens de stock

○ Available under request | Disponível sobre consulta | Disponible bajo consulta

Insert order code = (1) Geometry Code + (2) Grade Code

AMERICAN ACME | ANSI/ASME: 1.5-1988

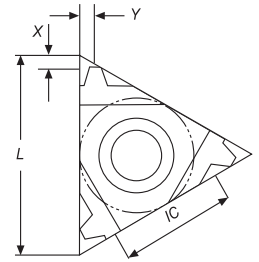
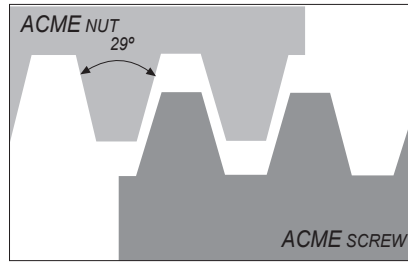
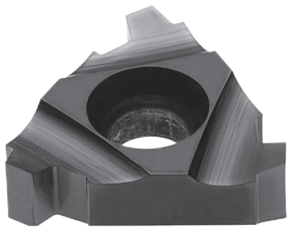

External

Geometry code ⁽¹⁾	Reference Referência Referencia	Pitch TPI	Dimensions Dimensões Dimensiones (mm)				Stock - Grade Code ⁽²⁾ (68) PH6920
			IC	L	X	Y	
1881871	11 ER 16 ACME	16	6.35	11	0.9	1.0	○
1881078	16 ER 16 ACME	16	9.525	16	0.9	1.0	⊗
1881077	16 ER 14 ACME	14	9.525	16	1.0	1.2	○
1881076	16 ER 12 ACME	12	9.525	16	1.1	1.2	○
1881075	16 ER 10 ACME	10	9.525	16	1.3	1.3	⊗
1881079	16 ER 8 ACME	8	9.525	16	1.5	1.5	⊗
1883784	16 ER 6 ACME	6	9.525	16	1.7	1.8	○
1881080	22 ER 6 ACME	6	12.70	22	1.8	2.1	⊗
1881081	22 ER 5 ACME	5	12.70	22	2.0	2.3	○
1883826	22 ER 4 ACME	4	12.70	22	2.1	2.2	○
1882159	27 ER 4 ACME	4	15.875	27	2.3	2.7	○
1881813	11 EL 16 ACME	16	6.35	11	0.9	1.0	○
1881997	16 EL 16 ACME	16	9.525	16	0.9	1.0	○
1881992	16 EL 14 ACME	14	9.525	16	1.0	1.2	○
1881990	16 EL 12 ACME	12	9.525	16	1.1	1.2	○
1881985	16 EL 10 ACME	10	9.525	16	1.3	1.3	○
1882024	16 EL 8 ACME	8	9.525	16	1.5	1.5	○
1883827	16 EL 6 ACME	6	9.525	16	1.7	1.8	○
1882133	22 EL 6 ACME	6	12.70	22	1.8	2.1	○
1882131	22 EL 5 ACME	5	12.70	22	2.0	2.3	○
1883785	22 EL 4 ACME	4	12.70	22	2.1	2.2	○
1882146	27 EL 4 ACME	4	15.875	27	2.3	2.7	○

⊗ Stock item | Produto de stock | Itens de stock

○ Available under request | Disponível sobre consulta | Disponible bajo consulta

Insert order code = (1) Geometry Code + (2) Grade Code

Internal

Geometry code ⁽¹⁾	Reference Referência Referencia	Pitch	Dimensions Dimensões Dimensiones (mm)				Stock - Grade Code ⁽²⁾
			TPI	IC	L	X	
1883786	08 IR 16 ACME	16	5.00	08	0.6	0.6	○
1881944	11 IR 16 ACME	16	6.35	11	0.9	1.0	○
1881107	16 IR 16 ACME	16	9.525	0.9	1.0	1.1	⊗
1881106	16 IR 14 ACME	14	9.525	1.0	1.2	1.2	○
1881105	16 IR 12 ACME	12	9.525	1.1	1.2	1.2	○
1881104	16 IR 10 ACME	10	9.525	1.3	1.3	1.4	○
1881103	16 IR 8 ACME	8	9.525	1.5	1.5	1.5	○
1881885	16 IR 6 ACME	6	9.525	1.7	1.8	1.5	○
1881083	22 IR 6 ACME	6	12.70	22	1.8	2.1	⊗
1881082	22 IR 5 ACME	5	12.70	22	2.0	2.3	○
1881102	22 IR 4 ACME	4	12.70	22	2.1	2.2	⊗
1882182	27 IR 4 ACME	4	15.875	27	2.3	2.7	○
1883787	08 IL 16 ACME	16	5.00	08	0.6	0.6	○
1881921	11 IL 16 ACME	16	6.35	11	0.9	1.0	○
1882080	16 IL 16 ACME	16	9.525	0.9	1.0	1.1	○
1882075	16 IL 14 ACME	14	9.525	1.0	1.2	1.2	○
1882072	16 IL 12 ACME	12	9.525	1.1	1.2	1.2	○
1882067	16 IL 10 ACME	10	9.525	1.3	1.3	1.4	○
1882102	16 IL 8 ACME	8	9.525	1.5	1.5	1.5	○
1882099	16 IL 6 ACME	6	9.525	1.7	1.8	1.5	○
1882140	22 IL 6 ACME	6	12.70	22	1.8	2.1	○
1882138	22 IL 5 ACME	5	12.70	22	2.0	2.3	○
1882136	22 IL 4 ACME	4	12.70	22	2.1	2.2	○
1882171	27 IL 4 ACME	4	15.875	27	2.3	2.7	○

⊗ Stock item | Produto de stock | Itens de stock

○ Available under request | Disponível sobre consulta | Disponible bajo consulta

Insert order code = (1) Geometry Code + (2) Grade Code

STUB ACME | ANSI/ASME: 1.8-1988

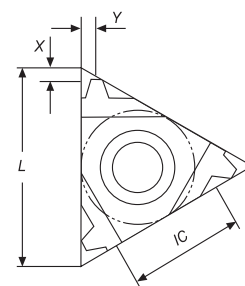
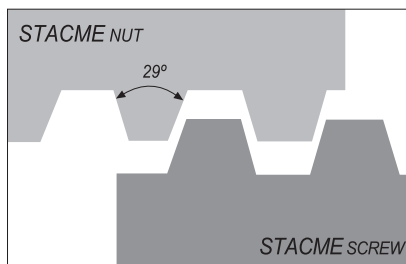
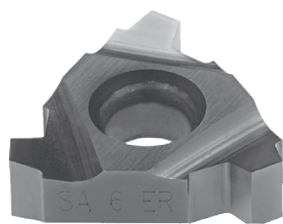

External

Geometry code ⁽¹⁾	Reference Referência Referencia	Pitch TPI	Dimensions Dimensões Dimensiones (mm)				Stock - Grade Code ⁽²⁾ (68) PH6920
			IC	L	X	Y	
1881872	11 ER 16 STACME	16	6.35	11	1.0	1.0	○
1881116	16 ER 16 STACME	16	9.525	16	1.0	1.0	○
1881117	16 ER 14 STACME	14	9.525	16	1.1	1.1	○
1881118	16 ER 12 STACME	12	9.525	16	1.2	1.2	○
1881119	16 ER 10 STACME	10	9.525	16	1.3	1.3	○
1881120	16 ER 8 STACME	8	9.525	16	1.5	1.5	○
1881121	16 ER 6 STACME	6	9.525	16	1.8	1.8	⊗
1882135	22 ER 6 STACME	6	12.70	22	1.8	2.1	○
1881122	22 ER 5 STACME	5	12.70	22	2.0	2.3	○
1881123	22 ER 4 STACME	4	12.70	22	2.3	2.4	○
1882160	27 ER 4 STACME	4	15.875	27	2.3	2.4	⊗
1882156	27 ER 3 STACME	3	15.875	27	2.8	2.9	○
1881814	11 EL 16 STACME	16	6.35	11	1.0	1.0	○
1881998	16 EL 16 STACME	16	9.525	16	1.0	1.0	○
1881996	16 EL 14 STACME	14	9.525	16	1.1	1.1	○
1881991	16 EL 12 STACME	12	9.525	16	1.2	1.2	○
1881986	16 EL 10 STACME	10	9.525	16	1.3	1.3	○
1882027	16 EL 8 STACME	8	9.525	16	1.5	1.5	○
1882021	16 EL 6 STACME	6	9.525	16	1.8	1.8	○
1882134	22 EL 6 STACME	6	12.70	22	1.8	2.1	○
1882132	22 EL 5 STACME	5	12.70	22	2.0	2.3	○
1881889	22 EL 4 STACME	4	12.70	22	2.3	2.4	○
1882147	27 EL 4 STACME	4	15.875	27	2.3	2.4	○
1882143	27 EL 3 STACME	3	15.875	27	2.8	2.9	○

⊗ Stock item | Produto de stock | Itens de stock

○ Available under request | Disponível sobre consulta | Disponible bajo consulta

Insert order code = (1) Geometry Code + (2) Grade Code

Internal

Geometry code ⁽¹⁾	Reference Referência Referencia	Pitch	Dimensions Dimensões Dimensiones (mm)				Stock - Grade Code ⁽²⁾
		TPI	IC	L	X	Y	(68) PH6920
1883788	08 IR 16 STACME	16	5.00	08	0.6	0.6	○
1881108	16 IR 16 STACME	16	9.525	16	1.0	1.0	○
1881109	16 IR 14 STACME	14	9.525	16	1.1	1.1	○
1881110	16 IR 12 STACME	12	9.525	16	1.2	1.2	○
1881111	16 IR 10 STACME	10	9.525	16	1.3	1.3	○
1881112	16 IR 8 STACME	8	9.525	16	1.5	1.5	○
1881113	16 IR 6 STACME	6	9.525	16	1.8	1.8	○
1882142	22 IR 6 STACME	6	12.70	22	1.8	2.1	○
1881114	22 IR 5 STACME	5	12.70	22	2.0	2.3	○
1881115	22 IR 4 STACME	4	12.70	22	2.3	2.4	○
1882183	27 IR 4 STACME	4	15.875	27	2.3	2.4	⊗
1882180	27 IR 3 STACME	3	15.875	27	2.8	2.9	○
1883789	08 IL 16 STACME	16	5.00	08	0.6	0.6	○
1882081	16 IL 16 STACME	16	9.525	16	1.0	1.0	○
1882079	16 IL 14 STACME	14	9.525	16	1.1	1.1	○
1882073	16 IL 12 STACME	12	9.525	16	1.2	1.2	○
1882068	16 IL 10 STACME	10	9.525	16	1.3	1.3	○
1882105	16 IL 8 STACME	8	9.525	16	1.5	1.5	○
1882100	16 IL 6 STACME	6	9.525	16	1.8	1.8	○
1882141	22 IL 6 STACME	6	12.70	22	1.8	2.1	○
1882139	22 IL 5 STACME	5	12.70	22	2.0	2.3	○
1882137	22 IL 4 STACME	4	12.70	22	2.3	2.4	○
1882172	27 IL 4 STACME	4	15.875	27	2.3	2.4	○
1882169	27 IL 3 STACME	3	15.875	27	2.8	2.9	○

⊗ Stock item | Produto de stock | Itens de stock

○ Available under request | Disponível sobre consulta | Disponible bajo consulta

Insert order code = (1) Geometry Code + (2) Grade Code

Thread milling - Inserts

Thread milling - Toolholders

Thread turning - Overview

Thread turning - Inserts

Thread turning - Toolholders

Thread turning - Spare Parts

Technical Data

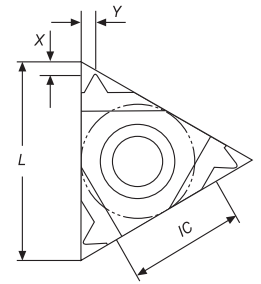
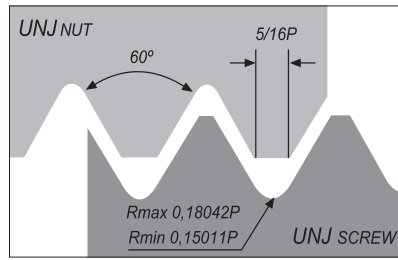
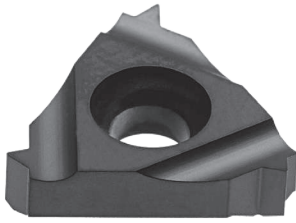

External

Geometry code ⁽¹⁾	Reference Referência Referencia	Pitch TPI	Dimensions Dimensões Dimensiones (mm)				Stock - Grade Code ⁽²⁾ (68) PH6920
			IC	L	X	Y	
1883790	11 ER 48 UNJ	48	6.35	11	0.6	0.6	○
1883791	11 ER 44 UNJ	44	6.35	11	0.6	0.6	○
1883792	11 ER 40 UNJ	40	6.35	11	0.6	0.6	○
1883793	11 ER 36 UNJ	36	6.35	11	0.6	0.6	○
1882318	11 ER 32 UNJ	32	6.35	11	0.6	0.6	○
1882319	11 ER 28 UNJ	28	6.35	11	0.6	0.6	○
1882320	11 ER 24 UNJ	24	6.35	11	0.7	0.8	○
1882321	11 ER 20 UNJ	20	6.35	11	0.8	0.9	○
1882322	11 ER 18 UNJ	18	6.35	11	0.8	1.0	○
1882323	11 ER 16 UNJ	16	6.35	11	0.8	1.0	○
1882324	11 ER 14 UNJ	14	6.35	11	0.9	1.0	○
1883794	16 ER 48 UNJ	48	9.525	16	0.6	0.6	○
1883795	16 ER 44 UNJ	44	9.525	16	0.6	0.6	○
1883796	16 ER 40 UNJ	40	9.525	16	0.6	0.6	○
1883797	16 ER 36 UNJ	36	9.525	16	0.6	0.6	○
1881165	16 ER 32 UNJ	32	9.525	16	0.6	0.6	○
1881164	16 ER 28 UNJ	28	9.525	16	0.6	0.6	○
1881163	16 ER 24 UNJ	24	9.525	16	0.7	0.8	○
1881162	16 ER 20 UNJ	20	9.525	16	0.8	0.9	○
1881161	16 ER 18 UNJ	18	9.525	16	0.8	1.0	○
1881160	16 ER 16 UNJ	16	9.525	16	0.8	1.0	○
1881159	16 ER 14 UNJ	14	9.525	16	1.0	1.2	○
1881158	16 ER 13 UNJ	13	9.525	16	1.0	1.3	○
1881157	16 ER 12 UNJ	12	9.525	16	1.1	1.4	○
1881156	16 ER 11 UNJ	11	9.525	16	1.1	1.5	○
1881155	16 ER 10 UNJ	10	9.525	16	1.1	1.5	○
1881154	16 ER 9 UNJ	9	9.525	16	1.2	1.6	○
1881153	16 ER 8 UNJ	8	9.525	16	1.2	1.6	○
1883798	11 EL 48 UNJ	48	6.35	11	0.6	0.6	○
1883799	11 EL 44 UNJ	44	6.35	11	0.6	0.6	○
1883800	11 EL 40 UNJ	40	6.35	11	0.6	0.6	○
1883801	11 EL 36 UNJ	36	6.35	11	0.6	0.6	○
1882325	11 EL 32 UNJ	32	6.35	11	0.6	0.6	○
1882326	11 EL 28 UNJ	28	6.35	11	0.6	0.6	○
1882327	11 EL 24 UNJ	24	6.35	11	0.7	0.8	○
1882328	11 EL 20 UNJ	20	6.35	11	0.8	0.9	○

Stock item | Produto de stock | Itens de stock

Available under request | Disponível sobre consulta | Disponible bajo consulta

Insert order code = (1) Geometry Code + (2) Grade Code

External

Geometry code ⁽¹⁾	Reference Referência Referencia	Pitch	Dimensions Dimensões Dimensiones (mm)				Stock - Grade Code ⁽²⁾
		TPI	IC	L	X	Y	(68) PH6920
1882329	11 EL 18 UNJ	18	6.35	11	0.8	1.0	○
1882330	11 EL 16 UNJ	16	6.35	11	0.8	1.0	○
1882331	11 EL 14 UNJ	14	6.35	11	0.9	1.0	○
1883802	16 ER 48 UNJ	48	9.525	16	0.6	0.6	○
1883803	16 ER 44 UNJ	44	9.525	16	0.6	0.6	○
1883804	16 ER 40 UNJ	40	9.525	16	0.6	0.6	○
1883805	16 ER 36 UNJ	36	9.525	16	0.6	0.6	○
1881179	16 EL 32 UNJ	32	9.525	16	0.6	0.6	○
1881178	16 EL 28 UNJ	28	9.525	16	0.6	0.6	○
1881177	16 EL 24 UNJ	24	9.525	16	0.7	0.8	○
1881176	16 EL 20 UNJ	20	9.525	16	0.8	0.9	○
1881175	16 EL 18 UNJ	18	9.525	16	0.8	1.0	○
1881174	16 EL 16 UNJ	16	9.525	16	0.8	1.0	○
1881173	16 EL 14 UNJ	14	9.525	16	1.0	1.2	○
1881172	16 EL 13 UNJ	13	9.525	16	1.0	1.3	○
1881170	16 EL 12 UNJ	12	9.525	16	1.1	1.4	○
1881169	16 EL 11 UNJ	11	9.525	16	1.1	1.5	○
1881168	16 EL 10 UNJ	10	9.525	16	1.1	1.5	○
1881167	16 EL 9 UNJ	9	9.525	16	1.2	1.6	○
1881166	16 EL 8 UNJ	8	9.525	16	1.2	1.6	○

⊗ Stock item | Produto de stock | Itens de stock

○ Available under request | Disponível sobre consulta | Disponible bajo consulta

Insert order code = (1) Geometry Code + (2) Grade Code

Internal

Geometry code ⁽¹⁾	Reference Referência Referencia	Pitch	Dimensions Dimensões Dimensiones (mm)				Stock - Grade Code ⁽²⁾
		TPI	IC	L	X	Y	(68) PH6920
1883806	11 IR 48 UNJ	48	6.35	11	0.6	0.6	○
1883807	11 IR 44 UNJ	44	6.35	11	0.6	0.6	○
1883808	11 IR 40 UNJ	40	6.35	11	0.6	0.6	○
1883809	11 IR 36 UNJ	36	6.35	11	0.6	0.6	○
1881198	11 IR 32 UNJ	32	6.35	11	0.6	0.6	○
1881197	11 IR 28 UNJ	28	6.35	11	0.6	0.6	○
1881196	11 IR 24 UNJ	24	6.35	11	0.7	0.8	○
1881195	11 IR 20 UNJ	20	6.35	11	0.8	0.9	○
1881194	11 IR 18 UNJ	18	6.35	11	0.8	1.0	○
1881193	11 IR 16 UNJ	16	6.35	11	0.8	1.0	○
1881192	11 IR 14 UNJ	14	6.35	11	0.9	1.0	○
1883810	16 IR 48 UNJ	48	9.525	16	0.6	0.6	○
1883811	16 IR 44 UNJ	44	9.525	16	0.6	0.6	○
1883812	16 IR 40 UNJ	40	9.525	16	0.6	0.6	○
1883813	16 IR 36 UNJ	36	9.525	16	0.6	0.6	○
1881191	16 IR 32 UNJ	32	9.525	16	0.6	0.6	○
1881190	16 IR 28 UNJ	28	9.525	16	0.6	0.6	○
1881189	16 IR 24 UNJ	24	9.525	16	0.7	0.8	○
1881188	16 IR 20 UNJ	20	9.525	16	0.8	0.9	○
1881187	16 IR 18 UNJ	18	9.525	16	0.8	1.0	○
1881186	16 IR 16 UNJ	16	9.525	16	0.8	1.0	○
1881185	16 IR 14 UNJ	14	9.525	16	1.0	1.2	○
1883814	16 IR 13 UNJ	13	9.525	16	1.0	1.3	○
1881184	16 IR 12 UNJ	12	9.525	16	1.1	1.4	⊗
1881183	16 IR 11 UNJ	11	9.525	16	1.1	1.5	○
1881182	16 IR 10 UNJ	10	9.525	16	1.1	1.5	⊗
1881181	16 IR 9 UNJ	9	9.525	16	1.2	1.6	○
1881180	16 IR 8 UNJ	8	9.525	16	1.2	1.6	○
1883815	11 IL 48 UNJ	48	6.35	11	0.6	0.6	○
1883816	11 IL 44 UNJ	44	6.35	11	0.6	0.6	○
1883817	11 IL 40 UNJ	40	6.35	11	0.6	0.6	○
1883818	11 IL 36 UNJ	36	6.35	11	0.6	0.6	○
1881217	11 IL 32 UNJ	32	6.35	11	0.6	0.6	○
1881216	11 IL 28 UNJ	28	6.35	11	0.6	0.6	○
1881215	11 IL 24 UNJ	24	6.35	11	0.7	0.8	○
1881214	11 IL 20 UNJ	20	6.35	11	0.8	0.9	○
1881213	11 IL 18 UNJ	18	6.35	11	0.8	1.0	○
1881188	11 IL 16 UNJ	16	6.35	11	0.8	1.0	○
1881211	11 IL 14 UNJ	14	6.35	11	0.9	1.0	○
1883819	16 IL 48 UNJ	48	9.525	16	0.6	0.6	⊗
1883820	16 IL 44 UNJ	44	9.525	16	0.6	0.6	⊗
1883821	16 IL 40 UNJ	40	9.525	16	0.6	0.6	○
1883822	16 IL 36 UNJ	36	9.525	16	0.6	0.6	○
1881210	16 IL 32 UNJ	32	9.525	16	0.6	0.6	⊗
1881209	16 IL 28 UNJ	28	9.525	16	0.6	0.6	○
1881208	16 IL 24 UNJ	24	9.525	16	0.7	0.8	⊗

⊗ Stock item | Produto de stock | Itens de stock

○ Available under request | Disponível sobre consulta | Disponible bajo consulta

Insert order code = (1) Geometry Code + (2) Grade Code

Internal

Geometry code ⁽¹⁾	Reference Referência Referencia	Pitch	Dimensions Dimensões Dimensiones (mm)				Stock - Grade Code ⁽²⁾
		TPI	IC	L	X	Y	(68) PH6920
1881207	16 IL 20 UNJ	20	9.525	16	0.8	0.9	○
1881206	16 IL 18 UNJ	18	9.525	16	0.8	1.0	○
1881205	16 IL 16 UNJ	16	9.525	16	0.8	1.0	○
1881204	16 IL 14 UNJ	14	9.525	16	1.0	1.2	○
1883823	16 IR 13 UNJ	13	9.525	16	1.0	1.3	○
1881203	16 IL 12 UNJ	12	9.525	16	1.1	1.4	○
1881202	16 IL 11 UNJ	11	9.525	16	1.1	1.5	○
1881201	16 IL 10 UNJ	10	9.525	16	1.1	1.5	○
1881200	16 IL 9 UNJ	9	9.525	16	1.2	1.6	○
1881199	16 IL 8 UNJ	8	9.525	16	1.2	1.6	○

 Stock item | Produto de stock | Itens de stock

 Available under request | Disponível sobre consulta | Disponible bajo consulta

Insert order code = (1) Geometry Code + (2) Grade Code

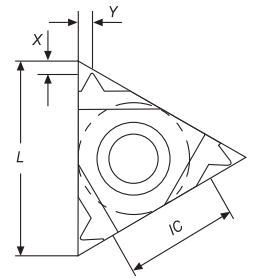
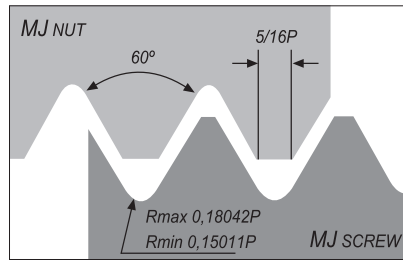
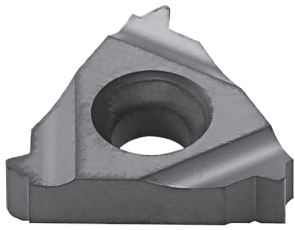

External

Geometry code ⁽¹⁾	Reference Referência Referencia	Pitch	Dimensions Dimensões Dimensiones (mm)				Stock - Grade Code ⁽²⁾
		MM	IC	L	X	Y	(68) PH6920
1881067	16 ER 1.0 MJ	1.0	9.525	16	0.7	0.8	○
1881068	16 ER 1.25 MJ	1.25	9.525	16	0.8	0.9	○
1881069	16 ER 1.5 MJ	1.5	9.525	16	0.8	1.0	○
1881070	16 ER 2.0 MJ	2.0	9.525	16	1.0	1.3	⊗

⊗ Stock item | Produto de stock | Itens de stock

○ Available under request | Disponível sobre consulta | Disponible bajo consulta

Insert order code = (1) Geometry Code + (2) Grade Code

Internal

Geometry code ⁽¹⁾	Reference Referência Referencia	Pitch	Dimensions Dimensões Dimensiones (mm)				Stock - Grade Code ⁽²⁾
		MM	IC	L	X	Y	(68) PH6920
1882370	11 IR 1.0 MJ	1.0	6.35	11	0.7	0.8	○
1882371	11 IR 1.25 MJ	1.25	6.35	11	0.8	0.9	○
1882372	11 IR 1.5 MJ	1.5	6.35	11	0.8	1.0	○
1883824	11 IR 2.0 MJ	2.0	6.35	11	0.9	1.0	○
1881071	16 IR 1.0 MJ	1.0	9.525	16	0.7	0.8	○
1881072	16 IR 1.25 MJ	1.25	9.525	16	0.8	0.9	○
1881073	16 IR 1.5 MJ	1.5	9.525	16	0.8	1.0	○
1881074	16 IR 2.0 MJ	2.0	9.525	16	1.0	1.3	○

⊗ Stock item | Produto de stock | Itens de stock

○ Available under request | Disponível sobre consulta | Disponible bajo consulta

Insert order code = (1) Geometry Code + (2) Grade Code

AMERICAN BUTTRESS | ANSI B1.9-1973

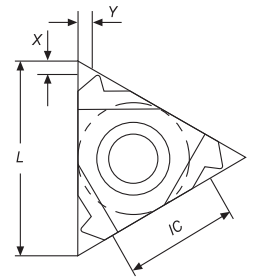
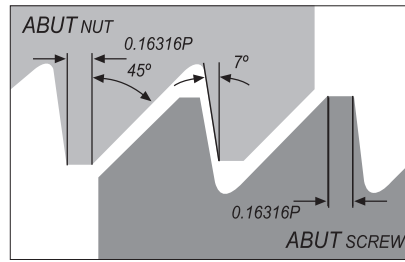
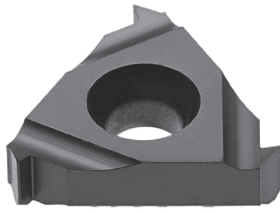

External

Geometry code ⁽¹⁾	Reference Referência Referencia	Pitch	Dimensions Dimensões Dimensiones (mm)				Stock - Grade Code ⁽²⁾
		TPI	IC	L	X	Y	(68) PH6920
1882298	11 ER 20 ABUT	20	6.35	11	1.0	1.3	○
1882299	11 ER 16 ABUT	16	6.35	11	1.0	1.5	○
1881007	16 ER 20 ABUT	20	9.525	16	1.0	1.3	○
1880754	16 ER 16 ABUT	16	9.525	16	1.0	1.5	○
1881006	16 ER 12 ABUT	12	9.525	16	1.4	2.0	○
1881005	16 ER 10 ABUT	10	9.525	16	1.5	2.3	○
1881008	22 ER 8 ABUT	8	12.70	22	2.1	3.3	○
1881009	22 ER 6 ABUT	6	12.70	22	2.1	3.4	○
1882300	11 EL 20 ABUT	20	6.35	11	1.0	1.4	○
1882301	11 EL 16 ABUT	16	6.35	11	1.1	1.6	○
1882302	16 EL 20 ABUT	20	9.525	16	1.0	1.3	○
1882303	16 EL 16 ABUT	16	9.525	16	1.0	1.5	○
1882304	16 EL 12 ABUT	12	9.525	16	1.4	2.0	○
1882305	16 EL 10 ABUT	10	9.525	16	1.5	2.3	○
1882306	22 EL 8 ABUT	8	12.70	22	2.1	3.3	○
1882307	22 EL 6 ABUT	6	12.70	22	2.1	3.4	○

☒ Stock item | Produto de stock | Itens de stock

○ Available under request | Disponível sobre consulta | Disponible bajo consulta

Insert order code = (1) Geometry Code + (2) Grade Code

Internal

Geometry code ⁽¹⁾	Reference Referência Referencia	Pitch	Dimensions Dimensões Dimensiones (mm)				Stock - Grade Code ⁽²⁾
		TPI	IC	L	X	Y	(68) PH6920
1882308	11 IR 20 ABUT	20	6.35	11	1.0	1.4	○
1882309	11 IR 16 ABUT	16	6.35	11	1.1	1.6	○
1881015	16 IR 20 ABUT	20	9.525	16	1.0	1.3	○
1881014	16 IR 16 ABUT	16	9.525	16	1.0	1.5	☒
1881013	16 IR 12 ABUT	12	9.525	16	1.4	2.0	○
1881012	16 IR 10 ABUT	10	9.525	16	1.5	2.3	○
1881011	22 IR 8 ABUT	8	12.70	22	2.1	3.3	○
1881010	22 IR 6 ABUT	6	12.70	22	2.1	3.4	○
1882310	11 IL 20 ABUT	20	6.35	11	1.0	1.4	○
1882311	11 IL 16 ABUT	16	6.35	11	1.1	1.6	○
1882312	16 IL 20 ABUT	20	9.525	16	1.0	1.3	○
1882313	16 IL 16 ABUT	16	9.525	16	1.0	1.5	○
1882314	16 IL 12 ABUT	12	9.525	16	1.4	2.0	○
1882315	16 IL 10 ABUT	10	9.525	16	1.5	2.3	○
1882316	22 IL 8 ABUT	8	12.70	22	2.1	3.3	○
1882317	22 IL 6 ABUT	6	12.70	22	2.1	3.4	○

☒ Stock item | Produto de stock | Itens de stock

○ Available under request | Disponível sobre consulta | Disponible bajo consulta

Insert order code = (1) Geometry Code + (2) Grade Code

METRIC BUTTRESS SAGENGWINDE (DIN 513:1985) SAW THREAD

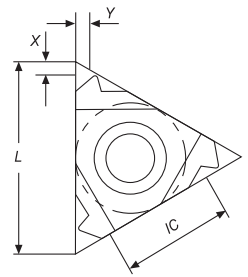
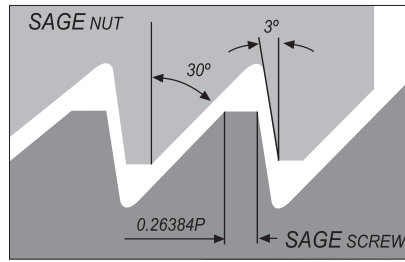
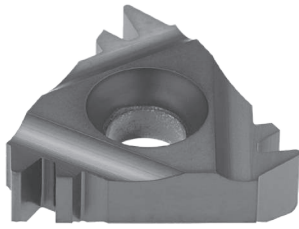

External

Geometry code ⁽¹⁾	Reference Referência Referencia	Pitch MM	Dimensions Dimensões Dimensiones (mm)				Stock - Grade Code ⁽²⁾ (68) PH6920
			IC	L	X	Y	
1882384	16 ER 2.0 SAGE	2.0	9.525	16	1.1	1.6	○
1882385	22 ER 3.0 SAGE	3.0	12.70	22	1.5	2.4	○
1882386	22 ER 4.0 SAGE	4.0	12.70	22	1.9	3.1	⊗
1882387	16 EL 2.0 SAGE	2.0	9.525	16	1.1	1.6	○
1882388	22 EL 3.0 SAGE	3.0	12.70	22	1.5	2.4	○
1882389	22 EL 4.0 SAGE	4.0	12.70	22	1.9	3.1	○

⊗ Stock item | Produto de stock | Itens de stock

○ Available under request | Disponível sobre consulta | Disponible bajo consulta

Insert order code = (1) Geometry Code + (2) Grade Code

Internal

Geometry code ⁽¹⁾	Reference Referência Referencia	Pitch MM	Dimensions Dimensões Dimensiones (mm)				Stock - Grade Code ⁽²⁾ (68) PH6920
			IC	L	X	Y	
1882390	16 IR 2.0 SAGE	2.0	9.525	16	1.2	1.7	○
1882391	22 IR 3.0 SAGE	3.0	12.70	22	1.9	2.9	○
1882392	22 IR 4.0 SAGE	4.0	12.70	22	2.3	3.5	○
1882393	16 IL 2.0 SAGE	2.0	9.525	16	1.2	1.7	○
1882394	22 IL 3.0 SAGE	3.0	12.70	22	1.9	2.9	○
1882395	22 IL 4.0 SAGE	4.0	12.70	22	2.3	3.5	○

⊗ Stock item | Produto de stock | Itens de stock

○ Available under request | Disponível sobre consulta | Disponible bajo consulta

Insert order code = (1) Geometry Code + (2) Grade Code

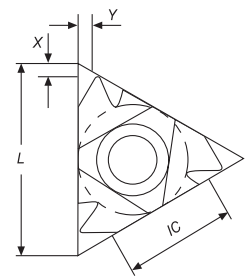
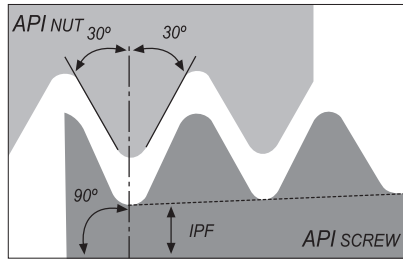
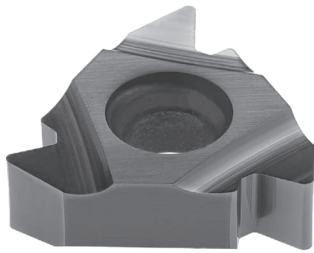

External

Geometry code ⁽¹⁾	Reference Referência Referencia	Pitch	Thread	Taper	Size	Dimensions Dimensões Dimensiones (mm)				Stock - Grade Code ⁽²⁾
		TPI		IPF		IC	L	X	Y	
1881326	22 ER 5.00 API 403	5	V-0.040	3	2 3/8" - 4 1/2" REG	12.70	22	1.8	2.5	⊗ (68) PH6920
1881322	22 ER 4.00 API 382	4	V-0.038R	2	NC23-NC50	12.70	22	2.0	2.6	○
1881323	22 ER 4.00 API 383	4	V-0.038R	3	NC56-NC77	12.70	22	2.0	2.6	⊗
1881324	22 ER 4.00 API 502	4	V-0.050	2	6 5/8" REG	12.70	22	1.9	2.8	○
1882396	27 ER 5.00 API 403	5	V-0.040	3	2 3/8" - 4 1/2" REG	15.875	27	1.9	2.7	○
1882397	27 ER 4.00 API 382	4	V-0.038R	2	NC23-NC50	15.875	27	2.1	2.8	○
1882398	27 ER 4.00 API 383	4	V-0.038R	3	NC56-NC77	15.875	27	2.1	2.8	○
1882399	27 ER 4.00 API 502	4	V-0.050	2	6 5/8" REG	15.875	27	2.0	3.0	⊗
1882400	27 ER 4.00 API 503	4	V-0.050	3	5 1/2" , 7 5/8" , 8 5/8" REG	15.875	27	2.0	3.0	○

⊗ Stock item | Produto de stock | Itens de stock

○ Available under request | Disponível sobre consulta | Disponible bajo consulta

Insert order code = (1) Geometry Code + (2) Grade Code

Internal

Geometry code ⁽¹⁾	Reference Referência Referencia	Pitch	Thread	Taper	Size	Dimensions Dimensões Dimensiones (mm)				Stock - Grade Code ⁽²⁾
		TPI		IPF		IC	L	X	Y	
1881335	22 IR 5.00 API 403	5	V-0.040	3	2 3/8" - 4 1/2" REG	12.70	22	1.8	2.5	⊗ (68) PH6920
1881331	22 IR 4.00 API 382	4	V-0.038R	2	NC23-NC50	12.70	22	2.0	2.6	○
1881333	22 IR 4.00 API 502	4	V-0.050	2	6 5/8" REG	12.70	22	1.9	2.8	○
1882401	27 IR 5.00 API 403	5	V-0.040	3	2 3/8" - 4 1/2" REG	15.875	27	1.9	2.7	○
1882402	27 IR 4.00 API 382	4	V-0.038R	2	NC23-NC50	15.875	27	2.1	2.8	○
1882403	27 IR 4.00 API 383	4	V-0.038R	3	NC56-NC77	15.875	27	2.1	2.8	○
1882404	27 IR 4.00 API 502	4	V-0.050	2	6 5/8" REG	15.875	27	2.0	3.0	○
1882405	27 IR 4.00 API 503	4	V-0.050	3	5 1/2" , 7 5/8" , 8 5/8" REG	15.875	27	2.0	3.0	○

⊗ Stock item | Produto de stock | Itens de stock

○ Available under request | Disponível sobre consulta | Disponible bajo consulta

Insert order code = (1) Geometry Code + (2) Grade Code

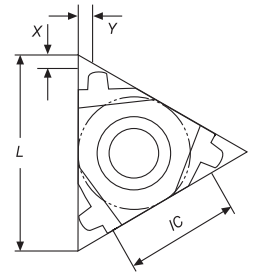
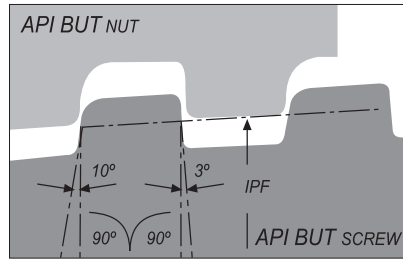
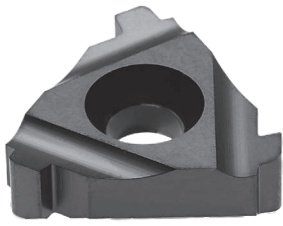

External

Geometry code ⁽¹⁾	Reference Referência Referencia	Pitch	Taper	Size	Dimensions Dimensões Dimensiones (mm)				Stock - Grade Code ⁽²⁾
		TPI	IPF		IC	L	X	Y	(68) PH6920
1881327	22 ER 5 BUT 0.75	5	0.75	4 1/2" - 13 3/8"	12.70	22	2.2	2.4	☉
1881328	22 ER 5 BUT 1.00	5	1.00	16" - 20"	12.70	22	2.3	2.4	○

☉ Stock item | Produto de stock | Itens de stock

○ Available under request | Disponível sobre consulta | Disponible bajo consulta

Insert order code = (1) Geometry Code + (2) Grade Code

Internal

Geometry code ⁽¹⁾	Reference Referência Referencia	Pitch	Taper	Size	Dimensions Dimensões Dimensiones (mm)				Stock - Grade Code ⁽²⁾
		TPI	IPF		IC	L	X	Y	(68) PH6920
1881336	22 IR 5 BUT 0.75	5	0.75	4 1/2" - 13 3/8"	12.70	22	2.2	2.4	☉
1881337	22 IR 5 BUT 1.00	5	1.00	16" - 20"	12.70	22	2.3	2.4	○

☉ Stock item | Produto de stock | Itens de stock

○ Available under request | Disponível sobre consulta | Disponible bajo consulta

Insert order code = (1) Geometry Code + (2) Grade Code

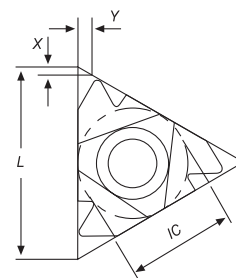
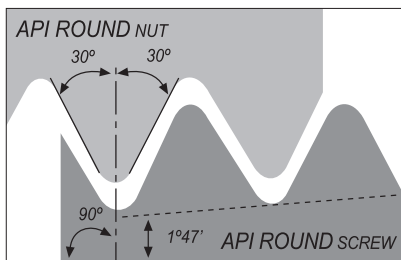
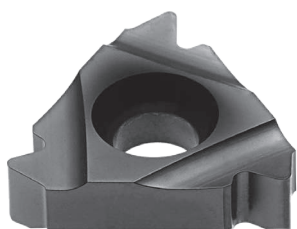

External

Geometry code ⁽¹⁾	Reference Referência Referencia	Pitch	Taper	Dimensions Dimensões Dimensiones (mm)				Stock - Grade Code ⁽²⁾
		TPI	IPF	IC	L	X	Y	(68) PH6920
1881318	16 ER 10 API RD	10	0.75	9.525	16	1.5	1.4	○
1881320	16 ER 8 API RD	8	0.75	9.525	16	1.3	1.6	⊗

⊗ Stock item | Produto de stock | Itens de stock

○ Available under request | Disponível sobre consulta | Disponible bajo consulta

Insert order code = (1) Geometry Code + (2) Grade Code

Internal

Geometry code ⁽¹⁾	Reference Referência Referencia	Pitch	Taper	Dimensions Dimensões Dimensiones (mm)				Stock - Grade Code ⁽²⁾
		TPI	IPF	IC	L	X	Y	(68) PH6920
1881319	16 IR 10 API RD	10	0.75	9.525	16	1.5	1.4	○
1881321	16 IR 8 API RD	8	0.75	9.525	16	1.3	1.6	○

⊗ Stock item | Produto de stock | Itens de stock

○ Available under request | Disponível sobre consulta | Disponible bajo consulta

Insert order code = (1) Geometry Code + (2) Grade Code

EXTREME LINE CASING | API SPEC 5B:2008 - OIL THREADS

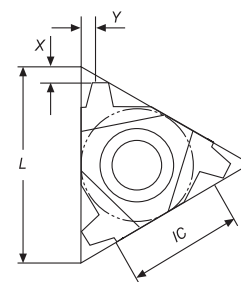
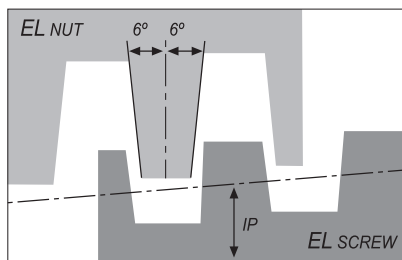
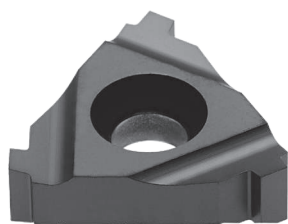

External

Geometry code ⁽¹⁾	Reference Referência Referencia	Pitch	Taper	Size	Dimensions Dimensões Dimensiones (mm)				Stock - Grade Code ⁽²⁾
		TPI	IPF		IC	L	X	Y	(68) PH6920
1881329	22 ER 6 EL 1.5	6	1.5	5" - 7 5/8"	12.70	22	1.9	1.9	○
1881330	22 ER 5 EL 1.25	5	1.25	8 5/8" - 10 3/4"	12.70	22	2.4	2.3	○

⊗ Stock item | Produto de stock | Itens de stock

○ Available under request | Disponível sobre consulta | Disponible bajo consulta

Insert order code = (1) Geometry Code + (2) Grade Code

Internal

Geometry code ⁽¹⁾	Reference Referência Referencia	Pitch	Taper	Size	Dimensions Dimensões Dimensiones (mm)				Stock - Grade Code ⁽²⁾
		TPI	IPF		IC	L	X	Y	(68) PH6920
1881339	22 IR 6 EL 1.5	6	1.5	5" - 7 5/8"	12.70	22	1.9	1.9	○
1881338	22 IR 5 EL 1.25	5	1.25	8 5/8" - 10 3/4"	12.70	22	2.4	2.3	○

⊗ Stock item | Produto de stock | Itens de stock

○ Available under request | Disponível sobre consulta | Disponible bajo consulta

Insert order code = (1) Geometry Code + (2) Grade Code

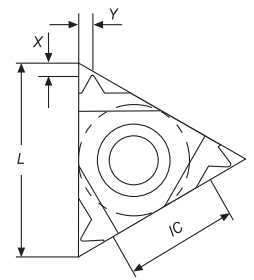
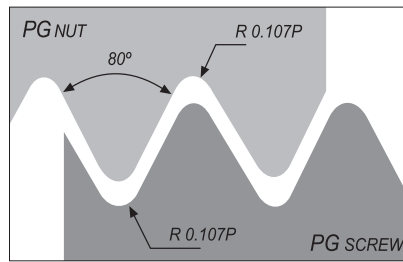
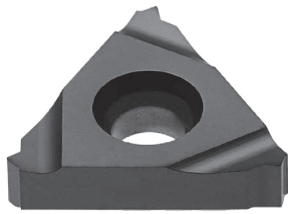

External

Geometry code ⁽¹⁾	Reference Referência Referencia	Pitch	Size	Dimensions Dimensões Dimensiones (mm)				Stock - Grade Code ⁽²⁾
		TPI		IC	L	X	Y	(68) PH6920
1882290	16 ER 20 PG	20	PG7	9.525	16	0.7	0.8	○
1882291	16 ER 18 PG	18	PG9, PG11, PG13.5, PG16	9.525	16	0.8	0.9	⊗
1882292	16 ER 16 PG	16	PG21, PG29, PG36, PG42, PG48	9.525	16	0.8	1.0	○

⊗ Stock item | Produto de stock | Itens de stock

○ Available under request | Disponível sobre consulta | Disponible bajo consulta

Insert order code = (1) Geometry Code + (2) Grade Code

Internal

Geometry code ⁽¹⁾	Reference Referência Referencia	Pitch	Size	Dimensions Dimensões Dimensiones (mm)				Stock - Grade Code ⁽²⁾
		TPI		IC	L	X	Y	(68) PH6920
1883825	08 IR 20 PG	20	PG7	5.0	8	0.6	0.7	○
1882294	11 IR 18 PG	18	PG9, PG11, PG13.5, PG16	6.35	11	0.8	0.9	○
1882296	16 IR 18 PG	18	PG9, PG11, PG13.5, PG16	9.525	16	0.8	0.9	○
1882297	16 IR 16 PG	16	PG21, PG29, PG36, PG42, PG48	9.525	16	0.8	1.0	○

⊗ Stock item | Produto de stock | Itens de stock

○ Available under request | Disponível sobre consulta | Disponible bajo consulta

Insert order code = (1) Geometry Code + (2) Grade Code

TANGENTIAL PROFILE INSERTS CODE KEY

Chave do codificação de pastilhas | Llave de codificación de plaquitas

Tangential Profile Example



1 - Insert Type

TNMC

TPMC

2 - Insert Size (L - mm)

16

16.50

22

22.00

3 - Insert Size (S - mm)

03

3.18

04

4.76

4 - Profile Angle

55

55°

60

60°

5 - Grades

PH6920

TNMC (TANGENTIAL INSERTS)

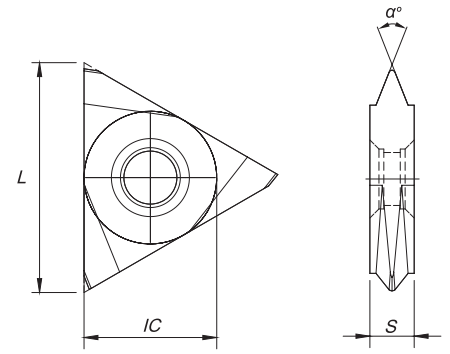
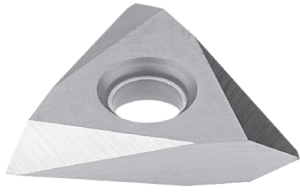

Geometry code ⁽¹⁾	Reference Referência Referencia	Dimensions Dimensões Dimensiones (mm)			α°	Stock - Grade Code ⁽²⁾
		IC	L	S		(68) PH6920
1110401	TNMC 1603 55	9.525	16.50	3.18	55	○
1110402	TNMC 1603 60	9.525	16.50	3.18	60	○
1110530	TNMC 2204 55	12.70	22.00	4.76	55	○
1110404	TNMC 2204 60	12.70	22.00	4.76	60	○

Stock item | Produto de stock | Itens de stock

Available under request | Disponível sobre consulta | Disponible bajo consulta

Insert order code = (1) Geometry Code + (2) Grade Code

TPMC (TANGENTIAL INSERTS)

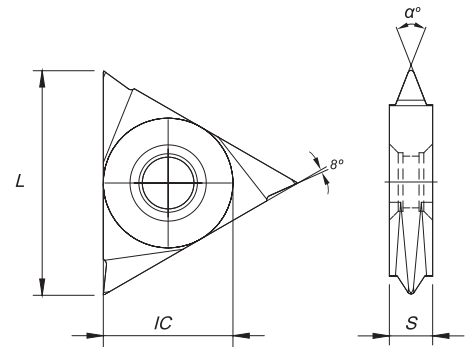
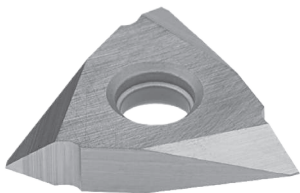

Geometry code ⁽¹⁾	Reference Referência Referencia	Dimensions Dimensões Dimensiones (mm)			α°	Stock - Grade Code ⁽²⁾
		IC	L	S		(68) PH6920
1110481	TPMC 1603 55	9.525	16.50	3.18	55	○
1110480	TPMC 1603 60	9.525	16.50	3.18	60	○
1110541	TPMC 2204 55	12.70	22.00	4.76	55	○
1110542	TPMC 2204 60	12.70	22.00	4.76	60	○

Stock item | Produto de stock | Itens de stock

Available under request | Disponível sobre consulta | Disponible bajo consulta

Insert order code = (1) Geometry Code + (2) Grade Code

EXTERNAL TOOLHOLDERS CODE KEY

Chave de codificação para suporte externos | Llave de codificación para roscado exterior

S	T	C	N	R	25	25	M	16
1	2	3	4	5	6	7	8	9

1 - Inserts Clamping System

2 - Insert Shape

80° C	55° D	75° E	55° K
R	90° S	60° T	35° V
80° W			

4 - Inserts Clearance Angle

5° B	7° C	0° N	11° P
----------------	----------------	----------------	-----------------

5 - Tool Hand

3 - Toolholder Leading Angle

90° A	75° B	90° C
45° D	60° E	90° F
90° G	107° 30' H	93° J
75° K	95° L	50° M
63° N	117° 30' Q	75° R
45° S	60° T	72° 30' V
113° X	100° Z	

6 - Height of Shank (mm)

7 - Width of Shank (mm)

8 - Length of Holder (mm)

	D	60	P	170
	E	70	R	200
	F	80	S	250
	H	100	T	300
	K	125	U	350
	L	140	V	400
	M	150	X	Special

9 - Length of Inserts Cutting Edge (mm)

STCN 90°

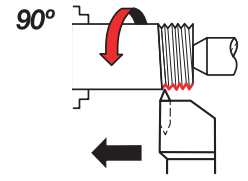
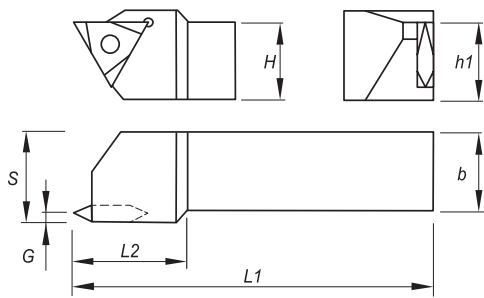

External Left

Order Code Código	Reference Referência Referencia	Insert Geometry	Dimensions Dimensões Dimensiones (mm)						Screw	Hex Key	Stock
			H=h1	b	S	L1	L2	G			
212129800	STCNL 1212 F16	TNMC/TPMC 16..	12	12	16	80	23	1.59	P0351375	SS20	☉
212129900	STCNL 1616 H16	TNMC/TPMC 16..	16	16	19	100	23	1.59	P0351375	SS20	☉
212029900	STCNL 2020 K16	TNMC/TPMC 16..	20	20	22	125	23	1.59	P0351375	SS20	☉
212130400	STCNL 2020 K22	TNMC/TPMC 22..	20	20	22	125	32	2.38	P0501975	SS25	☉
212030100	STCNL 2525 M16	TNMC/TPMC 16..	25	25	32	150	23	1.59	P0351375	SS20	☉
212030300	STCNL 2525 M22	TNMC/TPMC 22..	25	25	32	150	32	2.38	P0501975	SS25	☉
212130600	STCNL 3225 P22	TNMC/TPMC 22..	32	25	32	170	32	2.38	P0501975	SS25	☉
212130200	STCNL 3232 P16	TNMC/TPMC 16..	32	32	38	170	23	1.59	P0351375	SS20	☉
212130800	STCNL 3232 P22	TNMC/TPMC 22..	32	32	38	170	32	2.38	P0501975	SS25	☉

☉ Stock item | Produto de stock
Itens de stock

○ Available under request | Disponível sobre consulta
Disponível bajo consulta

External Right

Order Code Código	Reference Referência Referencia	Insert Geometry	Dimensions Dimensões Dimensiones (mm)						Screw	Hex Key	Stock
			H=h1	b	S	L1	L2	G			
212103600	STCNR 1212 F16	TNMC/TPMC 16..	12	12	16	80	23	1.59	P0351375	SS20	☉
212103700	STCNR 1616 H16	TNMC/TPMC 16..	16	16	19	100	23	1.59	P0351375	SS20	☉
212029800	STCNR 2020 K16	TNMC/TPMC 16..	20	20	22	125	23	1.59	P0351375	SS20	☉
212130300	STCNR 2020 K22	TNMC/TPMC 22..	20	20	22	125	32	2.38	P0501975	SS25	☉
212030000	STCNR 2525 M16	TNMC/TPMC 16..	25	25	32	150	23	1.59	P0351375	SS20	☉
212030200	STCNR 2525 M22	TNMC/TPMC 22..	25	25	32	150	32	2.38	P0501975	SS25	☉
212130500	STCNR 3225 P22	TNMC/TPMC 22..	32	25	32	170	32	2.38	P0501975	SS25	☉
212130100	STCNR 3232 P16	TNMC/TPMC 16..	32	32	38	170	23	1.59	P0351375	SS20	☉
212130700	STCNR 3232 P22	TNMC/TPMC 22..	32	32	38	170	32	2.38	P0501975	SS25	☉

☉ Stock item | Produto de stock
Itens de stock

○ Available under request | Disponível sobre consulta
Disponível bajo consulta

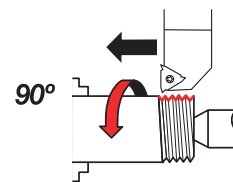
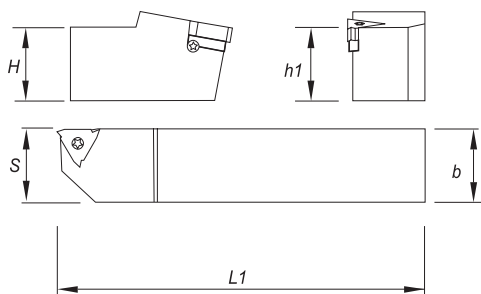

External Left

Order Code Código	Reference Referência Referencia	Insert Geometry	Dimensions Dimensões Dimensiones (mm)				Anvil	Anvil Screw	Insert Screw	Torx Key	Stock
			H=h1	b	S	L					
212244300	SXAN L 0808 H11	11 EL	8	8	11	100	-	-	P0260700	XT08	○
212244400	SXAN L 1010 H11	11 EL	10	10	11	100	-	-	P0260700	XT08	⊗
212384500	SXAN L 1212 K11	11 EL	12	12	12	125	-	-	P0260700	XT08	○
212384600	SXAN L 1212 F16	16 EL	12	12	16	80	IA16	P5000790	P5401390	XT10	○
212123400	SXAN L 1616 H16	16 EL	16	16	16	100	IA16	P5000790	P5401390	XT10	○
212123500	SXAN L 2020 K16	16 EL	20	20	20	125	IA16	P5000790	P5401390	XT10	⊗
212123800	SXAN L 2525 M16	16 EL	25	25	25	150	IA16	P5000790	P5401390	XT10	⊗
212124400	SXAN L 3232 P16	16 EL	32	32	32	170	IA16	P5000790	P5401390	XT10	○
212123900	SXAN L 2525 M22	22 EL	25	25	25	150	IA22	P8000990	P8001590	XT20	⊗
212124200	SXAN L 3232 P22	22 EL	32	32	32	170	IA22	P8000990	P8001590	XT20	⊗
212384700	SXAN L 4040 R22	22 EL	40	40	40	200	IA22	P8000990	P8001590	XT20	○
212244500	SXAN L 2525 M27	27 EL	25	25	32	150	IA27	P0500990	P0502200	XT25	○
212244600	SXAN L 3232 P27	27 EL	32	32	32	170	IA27	P0500990	P0502200	XT25	○
212384800	SXAN L 4040 R27	27 EL	40	40	40	200	IA27	P0500990	P0502200	XT25	○

⊗ Stock item | Produto de stock
Itens de stock

○ Available under request | Disponível sobre consulta
Disponível bajo consulta

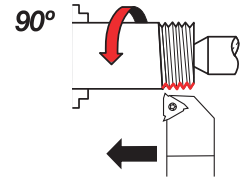
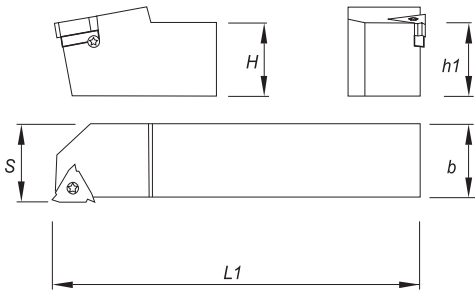

External Right

Order Code Código	Reference Referência Referencia	Insert Geometry	Dimensions Dimensões Dimensiones (mm)				Anvil	Anvil Screw	Insert Screw	Torx Key	Stock
			H=h1	b	S	L					
212244700	SXAN R 0808 H11	11 ER	8	8	10	100	-	-	P0260700	XT08	○
212244800	SXAN R 1010 H11	11 ER	10	10	10	100	-	-	P0260700	XT08	⊗
212384900	SXAN R 1212 K11	11 ER	12	12	12	125	-	-	P0260700	XT08	○
212383800	SXAN R 1212 F16	16 ER	12	12	16	80	EA16	P5000790	P5401390	XT10	⊗
212053800	SXAN R 1616 H16	16 ER	16	16	16	100	EA16	P5000790	P5401390	XT10	⊗
212053100	SXAN R 2020 K16	16 ER	20	20	20	125	EA16	P5000790	P5401390	XT10	⊗
212053200	SXAN R 2525 M16	16 ER	25	25	25	150	EA16	P5000790	P5401390	XT10	⊗
212124300	SXAN R 3232 P16	16 ER	32	32	32	170	EA16	P5000790	P5401390	XT10	⊗
212053000	SXAN R 2525 M22	22 ER	25	25	25	150	EA22	P8000990	P8001590	XT20	⊗
212124100	SXAN R 3232 P22	22 ER	32	32	32	170	EA22	P8000990	P8001590	XT20	⊗
212385100	SXAN R 4040 R22	22 ER	40	40	40	200	EA22	P8000990	P8001590	XT20	○
212244900	SXAN R 2525 M27	27 ER	25	25	32	150	EA27	P0500990	P0502200	XT25	○
212245000	SXAN R 3232 P27	27 ER	32	32	32	170	EA27	P0500990	P0502200	XT25	○
212385200	SXAN R 4040 R27	27 ER	40	40	40	200	EA27	P0500990	P0502200	XT25	○

⊗ Stock item | Produto de stock
Itens de stock

○ Available under request | Disponível sobre consulta
Disponível bajo consulta

INTERNAL TOOLHOLDERS CODE KEY

Chave de codificação para suporte internos | Llave de codificación para herramienta interior

S	32	U	S	T	G	N	R	16
1	2	3	4	5	6	7	8	9

1 - Bar Type

S	Steel shank
----------	-------------

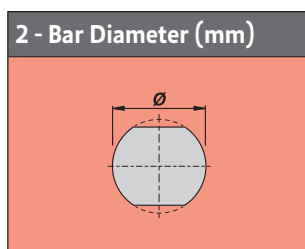

3 - Bar Length (mm)

H	100	T	300
J	110	U	350
K	125	V	400
L	140	W	450
M	150	Y	500
Q	180	X	Special
R	200		
S	250		

4 - Inserts Clamping System

C	M	P	S

5 - Insert Shape

C	D	E	K
S	T	V	W
X			

6 - Bar Leading Angle

F	K	L
Q	U	U-BT
G		

7 - Inserts Clearance Angle

B	C	N	P

8 - Bar Hand

L	R	N

9 - Length of Inserts Cutting Edge (mm)

C,D,E,V	K	S	T	W

STGN 90°

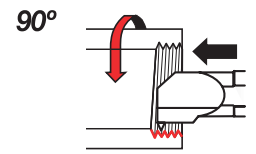
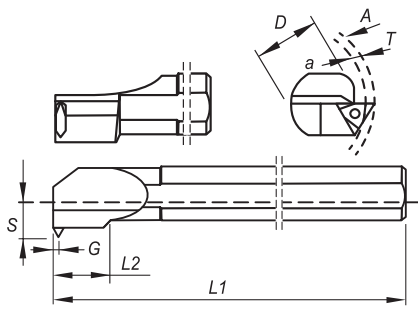

Internal Left

Order Code Código	Reference Referência Referencia	Insert	Dimensions Dimensões Dimensiones (mm)								Insert Screw	Hex Key	Stock
			D	L1	L2	S	A	a	T	G			
212121900	S32U STGN L 16	TNMC 1603..	32	350	19	21,0	50,4	45	2,7	1,59	P0351375	SS20	☺
212122200	S40V STGN L 16	TNMC 1603..	40	400	19	25,0	60,4	55	2,7	1,59	P0351375	SS20	☺
212122300	S32U STGN L 22	TNMC 2204..	32	350	28	21,0	50,4	45	4,1	2,38	P0501975	SS25	☺
212122600	S40V STGN L 22	TNMC 2204..	40	400	28	25,0	60,4	55	4,1	2,38	P0501975	SS25	☺
212122800	S50W STGN L 22	TNMC 2204..	50	450	28	36,5	78,2	70	4,1	2,38	P0501975	SS25	☺

☺ Stock item | Produto de stock
Itens de stock

○ Available under request | Disponível sobre consulta
Disponível bajo consulta

Internal Right

Order Code Código	Reference Referência Referencia	Insert	Dimensions Dimensões Dimensiones (mm)								Insert Screw	Hex Key	Stock
			D	L1	L2	S	A	a	T	G			
212053700	S32U STGN R 16	TNMC 1603..	32	350	19	21,0	50,4	45	2,7	1,59	P0351375	SS20	☺
212122100	S40V STGN R 16	TNMC 1603..	40	400	19	25,0	60,4	55	2,7	1,59	P0351375	SS20	☺
212122400	S32U STGN R 22	TNMC 2204..	32	350	28	21,0	50,4	45	4,1	2,38	P0501975	SS25	☺
212122500	S40V STGN R 22	TNMC 2204..	40	400	28	25,0	60,4	55	4,1	2,38	P0501975	SS25	☺
212122700	S50W STGN R 22	TNMC 2204..	50	450	28	36,5	78,2	70	4,1	2,38	P0501975	SS25	☺

☺ Stock item | Produto de stock
Itens de stock

○ Available under request | Disponível sobre consulta
Disponível bajo consulta

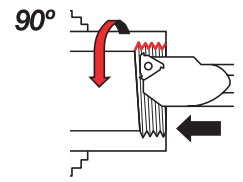
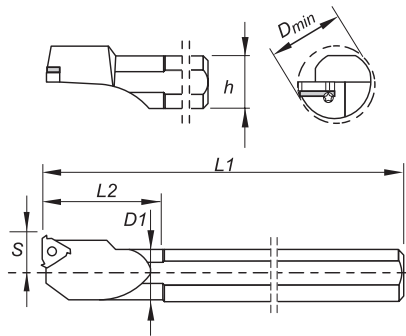

Internal Left

Order Code Código	Reference Referência Referencia	Insert Type	Dimensions Dimensões Dimensiones (mm)						Anvil	Anvil Screw	Insert Screw	Torx Key	Stock
			h	D1	Dmin	L1	L2	S					
212243500	S12H SXFN L 06	06 IL	12	5,1	6	100	12	4,3	-	-	P0200400	XT06	☉
212243600	S16K SXFN L 08	08 IL	16	6,6	7,8	125	18	5,3	-	-	P0200600	XT06	☉
212137600	S10H SXFN L 11	11 IL	10	10	12	100	-	7,4	-	-	P0260700	XT08	☉
212137800	S10K SXFN L 11	11 IL	16	10	12	125	25	7,4	-	-	P0260700	XT08	○
212385300	S13L SXFN L 11	11 IL	16	13	15	140	32	8,9	-	-	P0260700	XT08	○
212138000	S13M SXFN L 16	16 IL	16	13	16	150	32	10,2	-	-	P5401391	XT10	○
212127400	S16P SXFN L 16	16 IL	20	16	19	170	40	11,7	-	-	P5401391	XT10	☉
212138200	S20P SXFN L 16	16 IL	20	20	24	170	-	13,7	EA16	P5000790	P5401390	XT10	☉
212125500	S25R SXFN L 16	16 IL	25	25	29	200	-	16,2	EA16	P5000790	P5401390	XT10	☉
212125700	S32S SXFN L 16	16 IL	32	32	36	250	-	19,7	EA16	P5000790	P5401390	XT10	○
212125900	S40T SXFN L 16	16 IL	40	40	44	300	-	23,7	EA16	P5000790	P5401390	XT10	○
212138300	S20P SXFN L 22	22 IL	20	20	24	170	-	15,6	-	-	P8001591	XT20	☉
212126300	S25R SXFN L 22	22 IL	25	25	29	200	-	18,1	EA22	P8000990	P8001590	XT20	☉
212126500	S32S SXFN L 22	22 IL	32	32	38	250	-	21,6	EA22	P8000990	P8001590	XT20	☉
212126700	S40T SXFN L 22	22 IL	40	40	46	300	-	25,6	EA22	P8000990	P8001590	XT20	○
212243700	S32S SXFN L 27	27 IL	32	32	40	250	-	22,6	EA27	P0500990	P0502200	XT25	☉
212243800	S40T SXFN L 27	27 IL	40	40	48	300	-	26,6	EA27	P0500990	P0502200	XT25	○

☉ Stock item | Produto de stock
Itens de stock

○ Available under request | Disponível sobre consulta
Disponível bajo consulta

Note: All the toolholders SXFN are made with 1,5° helix angle. | Todos os ferros de torno são fornecidos com um ângulo de hélice de 1,5° | Todos los soportes se hacen con un ángulo de hélice de 1,5°.

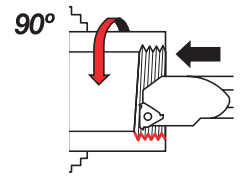
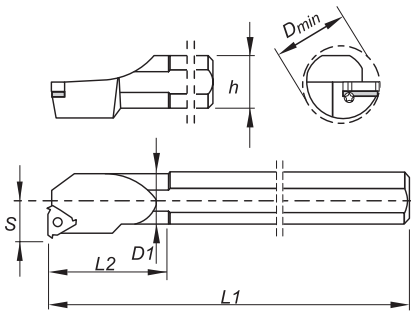

Internal Right

Order Code Código	Reference Referência Referencia	Insert Type	Dimensions Dimensões Dimensiones (mm)						Anvil	Anvil Screw	Insert Screw	Torx Key	Stock
			h	D1	Dmin	L1	L2	S					
212243900	S12H SXFN R 06	06 IR	12	5	6,1	100	12	4,4	-	-	P0200400	XT06	⊗
212244000	S16K SXFN R 08	08 IR	16	6,5	8	125	17	5,4	-	-	P0200600	XT06	⊗
212137700	S10H SXFN R 11	11 IR	10	10	12,5	100	-	7,3	-	-	P0260700	XT08	⊗
212137900	S10K SXFN R 11	11 IR	16	10	12,5	125	25	7,3	-	-	P0260700	XT08	○
212385400	S10L SXFN R 11	11 IR	16	13	15	140	32	8,9	-	-	P0260700	XT08	○
212138100	S13M SXFN R 16	16 IR	16	13	16,5	150	32	10,4	-	-	P5401391	XT10	○
212127300	S16P SXFN R 16	16 IR	20	16	19,5	170	40	11,6	-	-	P5401391	XT10	⊗
212138400	S20P SXFN R 16	16 IR	20	20	23,5	170	-	13,6	IA16	P5000790	P5401390	XT10	⊗
212125400	S25R SXFN R 16	16 IR	25	25	28,5	200	-	16,3	IA16	P5000790	P5401390	XT10	⊗
212125600	S32S SXFN R 16	16 IR	32	32	35,5	250	-	19,6	IA16	P5000790	P5401390	XT10	○
212125800	S40T SXFN R 16	16 IR	40	40	43,5	300	-	23,6	IA16	P5000790	P5401390	XT10	○
212138500	S20P SXFN R 22	22 IR	20	20	25	170	-	15,5	-	-	P8001591	XT20	⊗
212126200	S25R SXFN R 22	22 IR	25	25	30	200	-	18,3	IA22	P8000990	P8001590	XT20	⊗
212126400	S32S SXFN R 22	22 IR	32	32	37	250	-	21,7	IA22	P8000990	P8001590	XT20	⊗
212126600	S40T SXFN R 22	22 IR	40	40	45	300	-	25,7	IA22	P8000990	P8001590	XT20	○
212244100	S32S SXFN R 27	27 IR	32	32	39	250	-	22,8	IA27	P0500990	P0502200	XT25	⊗
212244200	S40T SXFN R 27	27 IR	40	40	47	300	-	26,8	IA27	P0500990	P0502200	XT25	○

⊗ Stock item | Produto de stock
Itens de stock

○ Available under request | Disponível sobre consulta
Disponível bajo consulta

Note: All the toolholders SXFN are made with 1,5° helix angle. | Todos os ferros de torno são fornecidos com um ângulo de hélice de 1,5° | Todos los soportes se hacen con un ángulo de hélice de 1,5°.

STGP 90°

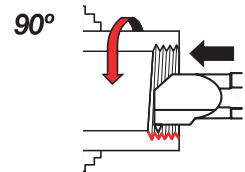
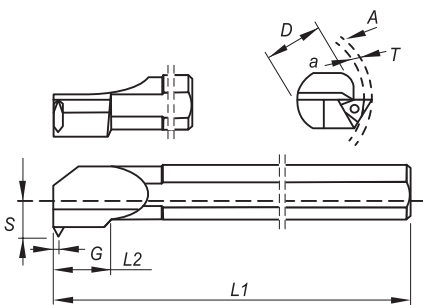

Internal Left

Order Code Código	Reference Referência Referencia	Insert	Dimensions Dimensões Dimensiones (mm)								Insert Screw	Hex Key	Stock
			D	L1	L2	S	A	a	T	G			
212030500	S25T STGP L 16	TPMC 1603..	25	300	19	17,5	50,4	45	2,7	1,59	P0351375	SS20	☺
212030700	S32U STGP L 16	TPMC 1603..	32	350	19	20,5	50,4	45	2,7	1,59	P0351375	SS20	☺
212030900	S40V STGP L 22	TPMC 2204..	40	400	28	25,0	78,2	70	4,1	2,38	P0501975	SS25	☺
212123000	S50W STGP L 22	TPMC 2204..	50	450	28	36,5	78,2	70	4,1	2,38	P0501975	SS25	☺

☺ Stock item | Produto de stock
Itens de stock

○ Available under request | Disponível sobre consulta
Disponível bajo consulta

Internal Right

Order Code Código	Reference Referência Referencia	Insert	Dimensions Dimensões Dimensiones (mm)								Insert Screw	Hex Key	Stock
			D	L1	L2	S	A	a	T	G			
212030400	S25T STGP R 16	TPMC 1603..	25	300	19	17,5	50,4	45	2,7	1,59	P0351375	SS20	☺
212030600	S32U STGP R 16	TPMC 1603..	32	350	19	20,5	50,4	45	2,7	1,59	P0351375	SS20	☺
212030800	S40V STGP R 22	TPMC 2204..	40	400	28	25,0	78,2	70	4,1	2,38	P0501975	SS25	☺
212122900	S50W STGP R 22	TPMC 2204..	50	450	28	36,5	78,2	70	4,1	2,38	P0501975	SS25	☺

☺ Stock item | Produto de stock
Itens de stock

○ Available under request | Disponível sobre consulta
Disponível bajo consulta



Screws

Order Code Código	Reference Referência Referencia	Stock
290025900	P0200600	○
290044800	P0260700	⊗
290027200	P0351375	⊗
290027500	P0500990	○
290027800	P0501975	⊗
290055000	P0502200	○
290045100	P5000790	⊗
290044600	P5401390	⊗
290044900	P5401391	⊗
290045200	P8000990	⊗
290044700	P8001590	⊗
290045000	P8001591	⊗

⊗ Stock item | Produto de stock | Itens de stock

○ Available under request | Disponível sobre consulta | Disponible bajo consulta



Keys

Order Code Código	Reference Referência Referencia	Stock
290011400	XT06	⊗
290011700	XT08	⊗
290013100	XT10	⊗
290013200	XT20	⊗
290017400	XT25	⊗
290020300	SS20	○
290019800	SS25	○

⊗ Stock item | Produto de stock | Itens de stock

○ Available under request | Disponível sobre consulta | Disponible bajo consulta



Shims

Order Code Código	Reference Referência Referencia	Stock
212134400	EA16	○
212134500	EA16 1,5N	○
212134600	EA16 1N	○
212134700	EA16 1P	○
212134800	EA16 2N	○
212134900	EA16 2P	○
212135000	EA16 3N	○
212135100	EA16 3P	○
212135200	EA22	○
212135300	EA22 1,5N	○
212135400	EA22 1N	○
212135500	EA22 1P	○
212135600	EA22 2N	○
212135700	EA22 2P	○
212135800	EA22 3N	○
212135900	EA22 3P	○
212136000	IA16	○
212136100	IA16 1,5N	○
212136200	IA16 1N	○
212136300	IA16 1P	○
212136400	IA16 2N	○
212136500	IA16 2P	○
212136600	IA16 3N	○
212136700	IA16 3P	○
212136800	IA22	○
212136900	IA22 1,5N	○
212137000	IA22 1N	○
212137100	IA22 1P	○
212137200	IA22 2N	○
212137300	IA22 2P	○
212137400	IA22 3N	○
212137500	IA22 3P	○

⊗ Stock item | Produto de stock | Itens de stock

○ Available under request | Disponível sobre consulta | Disponible bajo consulta

mm

THREADING

Thread milling - Inserts

Thread milling - Toolholders

Thread turning - Overview

Thread turning - Inserts

Thread turning - Toolholders

Thread turning - Spare Parts

Technical Data

THREADING TECHNICAL DATA

THREADING GRADES | Graus de roscagem | Calidades para roscado

	1	5	10	15	20	25	30	35	40	45	50		
P STEEL				PH7(6) 920									PVD
M STAINLESS STEEL				PH7(6) 920									PVD
K CAST IRON				PH7(6) 920									PVD
N ALUMINIUM & NON FERROUS			PH7(6) 920									PVD	
S HEAT RESISTENT / TITANIUM ALLOYS				PH7(6) 920									PVD

m

THREADING

Thread milling - Inserts

Thread milling - Toolholders

Thread turning - Overview

Thread turning - Inserts

Thread turning - Toolholders

Thread turning - Spare Parts

Technical Data

GRADES DESCRIPTION | Descrição de graus | Descripción de calidades

PH7920

PH6920

P10-P35

M10-M25

K10-K30

N05-N15

S10-S30

Multi purpose PVD coated grade with good balance between wear resistance and toughness.

RECOMMENDED GRADES AND CUTTING SPEEDS (M/MIN)

Graus recomendados e velocidades de corte (m/min) | Calidades recomendadas y velocidades de corte (m/min)

ISO	Material	Hardness HB	Coated
			PH7(6)920
P	UNALLOYED STEEL	130	120-200
	LOW-ALLOYED STEEL	200	110-180
	HIGH-ALLOY STEEL	240	100-170
	STEEL CASTINGS	270	70-120
	HEAT TREATED STEEL	400	50-90
M	300 STAINLESS STEEL: (303,304,316)	200	70-140
	400 STAINLESS STEEL: (420,440)	240	80-120
	17-4 PH, 15-5 PH, 13-8MO PH	400	50-110
K	GREY CAST IRON	190	70-150
	NODULAR CAST IRON	180	100-140
	MALLEABLE CAST IRON	240	90-150
N	WROUGHT ALUMINIUM: (2024, 6061, 7075...)	80	100-400
	CAST ALUMINIUM:	90	150-400
	COPPER & COPPER: BRASS, BRONZE, COPPER SILICON	100	80-180
	NON METALIC: Rubber, Polypropylene, Thermoplastics (PVC), Thermoplastics Plastics (FIBERGLASS), Polyamides		200-500
S	TITANIUM:		
	PURE TITANIUM: 99,0Ti		100-150
	ALPHA ALLOYS: Ti5A12.5Sn		40-60
	BETA ALLOYS: Ti 13V11Cr3A1		30-50
	ALPHA - BETA ALLOYS: Ti 6A14V		30-50
	COBALT BASE ALLOYS: STELLITE		20-40
	NIKEL BASE ALLOYS: INCONEL, HASTELLOY, WASPALLOY, KOVAR		20-40
	HIGH TEMPERATURE ALLOYS: IRON BASED: INCOLOY		30-60
H	HARDENED STEEL	56 HRc	-
	HARDENED CAST IRON	50 HRc	-

THREADING TECHNICAL DATA

THREAD TERMINOLOGY | Terminologia da roscagem | Terminología del roscado

External Thread
A thread on the external surface of a cylinder screw or cone.

Depth of Thread
The distance between crest and root measured normal to the axis.

Pitch
The distance between corresponding points on adjacent thread forms measured parallel to the axis. This distance can be defined in millimeters or by the *tpi* (threads per inch), which is the reciprocal of the pitch

Nominal Diameter
The diameter from which the diameter limits are derived by the application of deviation allowances and tolerances.

EXTERNAL THREAD

INTERNAL THREAD
A thread on the internal surface of a cylinder or cone.

Major Diameter
The largest diameter of a screw thread.

Pitch Diameter
On a straight thread, the diameter of an imaginary cylinder, the surface of which cuts the thread forms where the width of the thread and groove are equal.

Minor Diameter
The smallest diameter of a screw thread.

Helix Angle
For a straight thread, where the lead of the thread and the pitch diameter circle circumference form a right angled triangle, the helix angle is the angle opposite the lead.

Straight Thread
A thread formed on a cylinder.

Taper Thread
A thread formed on a cone.

LEFT-HAND THREAD

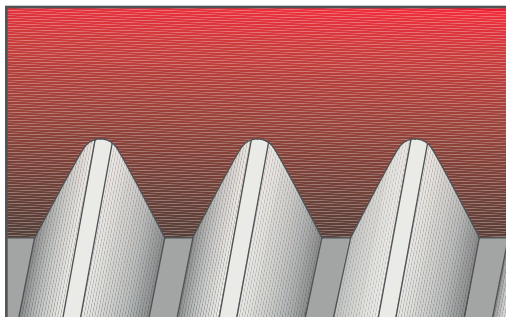

A thread which, when viewed axially, winds in a counter-clockwise and receding direction. All left-hand threads are designated LH.

RIGHT-HAND THREAD

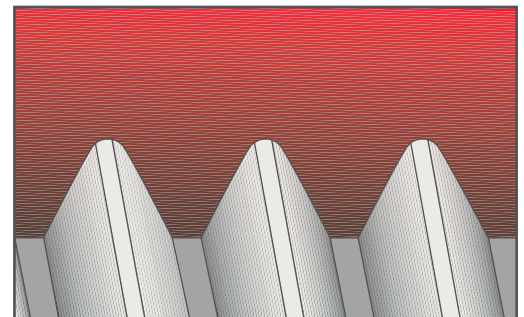

A thread which, when viewed axially, winds in a clockwise and receding direction. Threads are always right hand unless otherwise specified.

THE HELIX ANGLE

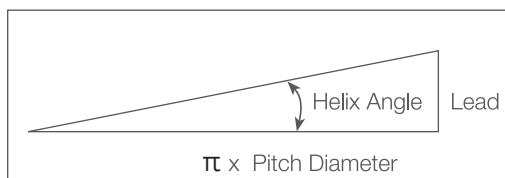

Lead

The distance a threaded part moves axially, with respect to a fixed mating part, in one complete revolution. The lead is equal to the pitch multiplied by the number of thread starts.

INSERT PROFILE STYLES | Estilos de perfis das pastilhas | Estilos de perfiles de las plaquitas

PARTIAL PROFILE

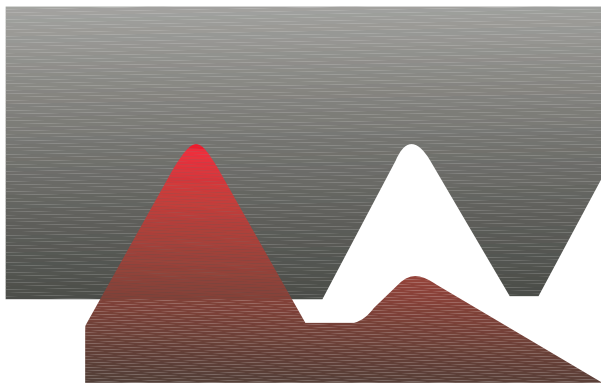

The V partial profile insert cuts without topping the outer diameter of the thread. The same insert can be used for a range of different thread pitches which have a common thread angle.

FULL PROFILE

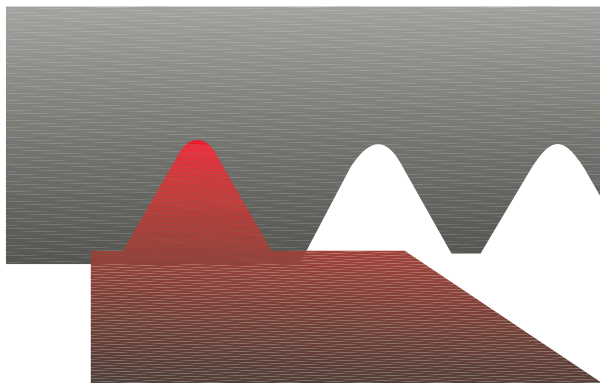

The full profile insert will form a complete thread profile including the crest. For every thread pitch and standard, a separate insert is required.

FULL PROFILE FOR FINE PITCHES

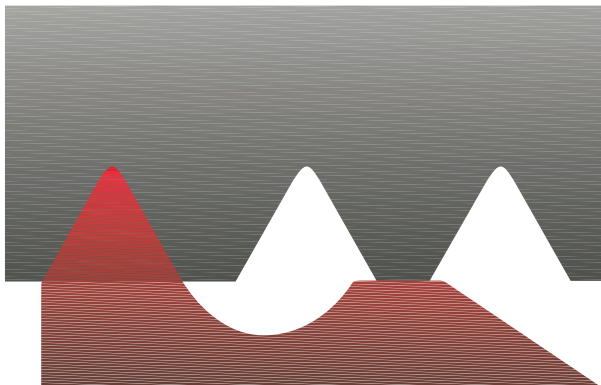

The full profile for Fine Pitches will form a complete thread. The topping of the outer diameter is generated by second tooth.

SEMI FULL

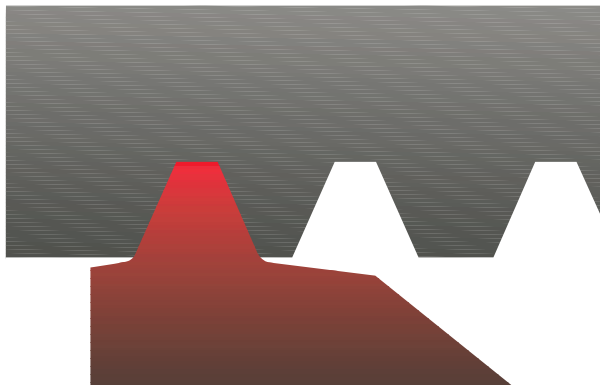

The Semi profile insert will form a complete thread including crest radius but without topping the outer diameter. Mainly used for trapezoidal profiles.

THREADING TECHNICAL DATA

THREAD WORK METHODS | Métodos de trabalho de roscagem | Métodos de trabajo de roscado

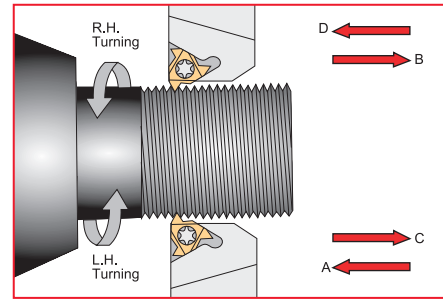
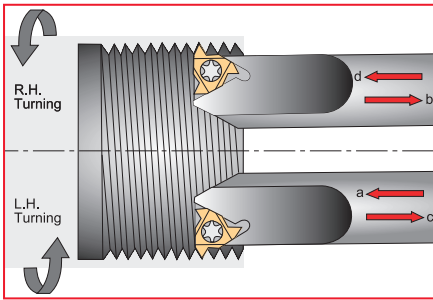

Thread	Inserts & Toolholders	Rotation	Feed Direction	Helix Method	Method
Right Hand external	EX RH	Anticlockwise	Towards chuck	Regular	A
	EX LH	Clockwise	From chuck	Reversed	B
Right Hand Internal	IN RH	Anticlockwise	Towards chuck	Regular	a
	IN LH	Clockwise	From chuck	Reversed	b
Left Hand External	EX LH	Clockwise	Towards chuck	Regular	D
	EX RH	Anticlockwise	From chuck	Reversed	C
Left Hand Internal	IN LH	Clockwise	Towards chuck	Regular	d
	IN RH	Anticlockwise	From chuck	Reversed	c

THREAD INFEEED METHODS | Métodos de roscagem infeed | Métodos de roscado infeed

RADIAL INFEEED

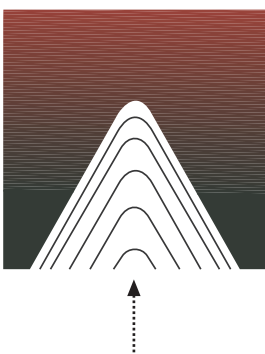

Radial infeed is the simplest and quickest method.

The feed is perpendicular to the turning axis, and both flanks of the insert perform the cutting operation.

Radial infeed is recommended in 3 cases:

- when the pitch is smaller than 16 tpi
- for material with short chips
- for work with hardened material

FLANK INFEEED (modified)

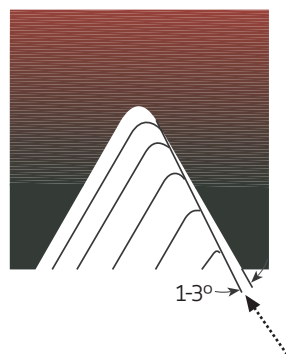

Flank infeed is recommended in the following cases:

- when the thread pitch is greater than 16 tpi., using the radial method, the effective cutting edge length is too large, resulting in chatter.
- for TRAPEZ and ACME. The radial method result in three cutting edges, making chip flow very difficult.

ALTERNATE FLANK INFEEED

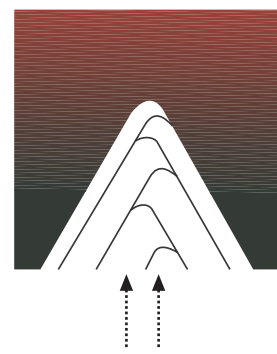

Use of the alternate flank method is recommended especially in large pitches and for materials with long chips.

This method divides the load equally on both flanks, resulting in equal wear along the cutting edges. Alternate flank infeed requires more complicated programming, and is not available on all lathes.

CALCULATE THE HELIX ANGLE AND CHOOSE THE RIGHT ANVIL

Calcular o ângulo de hélice e escolher o colchão adequado | Calcular el ángulo de hélice y elegir el colchón adecuado

FLANK CLEARANCE ANGLE (a)

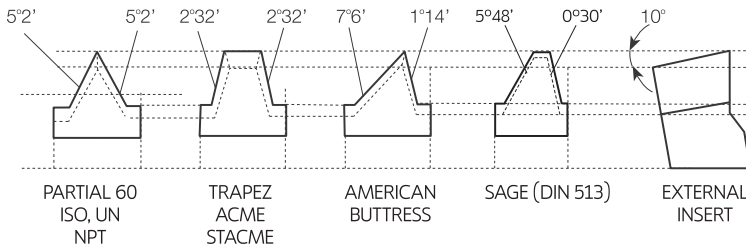

Palbit toolholders are designed to tilt the insert when seated in the toolholder (10° for external, 15° for internal tooling). This results in the differing flank clearance angles, based on the geometry of insert. To ensure that the side of the insert cutting edge will not rub on the workpiece, it is most important that the insert helix angle be correct - especially in profiles with small enclosed flank angles. This correction is provided by Palbit anvils.

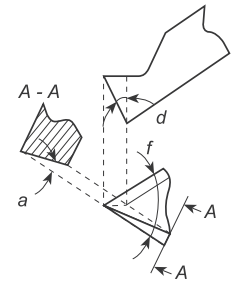

$$a = \arctan(\tan \varnothing / 2 \times \tan d)$$

Where: a - flank clearance angle
d - Tilt angle
Ø - Enclosed flank angle

CALCULATING THE HELIX ANGLE (b)

FORMULA

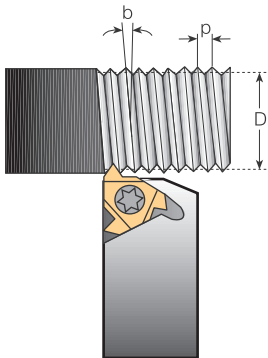

The helix angle is calculated by the following formula:

$$b = \arctan \frac{P \times N}{\pi \times D}$$

b - Helix angle (°)
P - Pitch (1/TPI)
N - No. of starts
D - Pitch diameter (mm)
Lead = P × N
TPI = Threads per inches

The helix angle can also be found using the diagram below

THREADING TECHNICAL DATA

The chart below represents the relation between diameter, pitch and anvil choice. When change of anvil is required, use EA anvils for ER and IL toolholders and IA anvils for IR and EL toolholders.

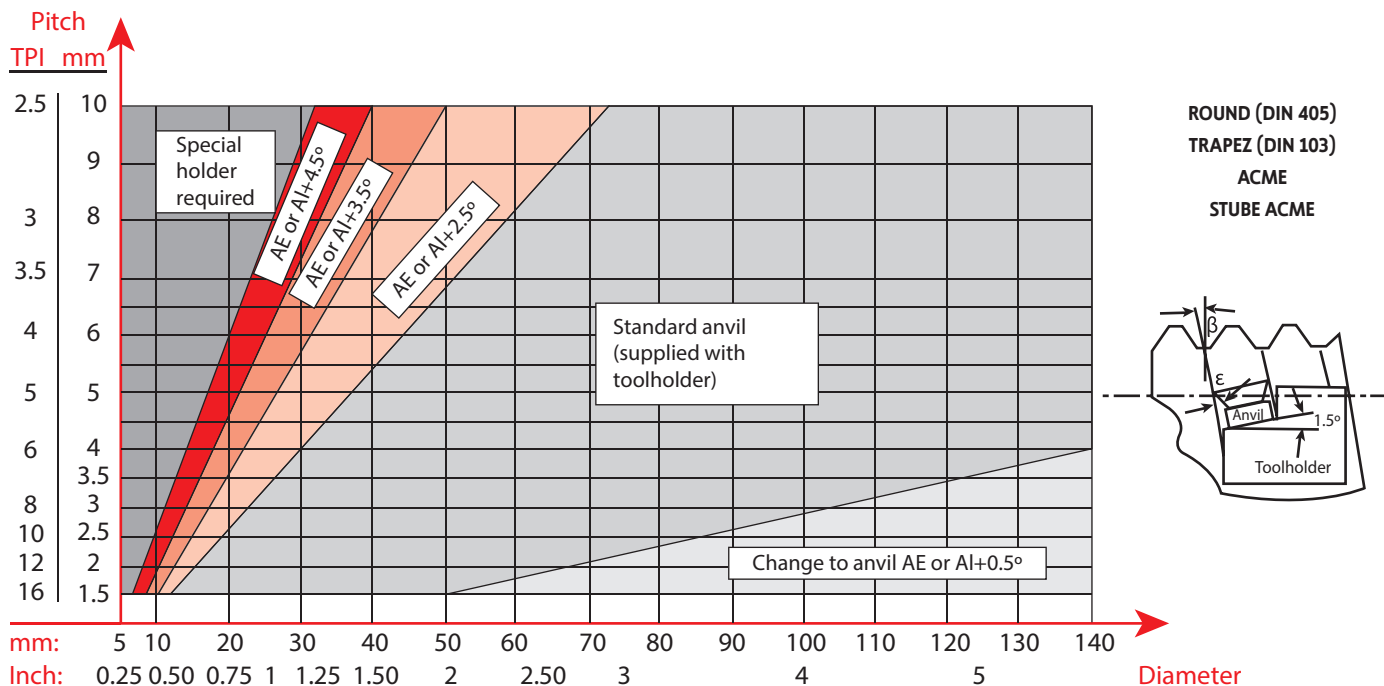

The majority of applications do not require an anvil change as it can be seen in the chart below. When change is required, use EA anvils for ER and IL toolholders and IA anvils for IR and EL toolholders.

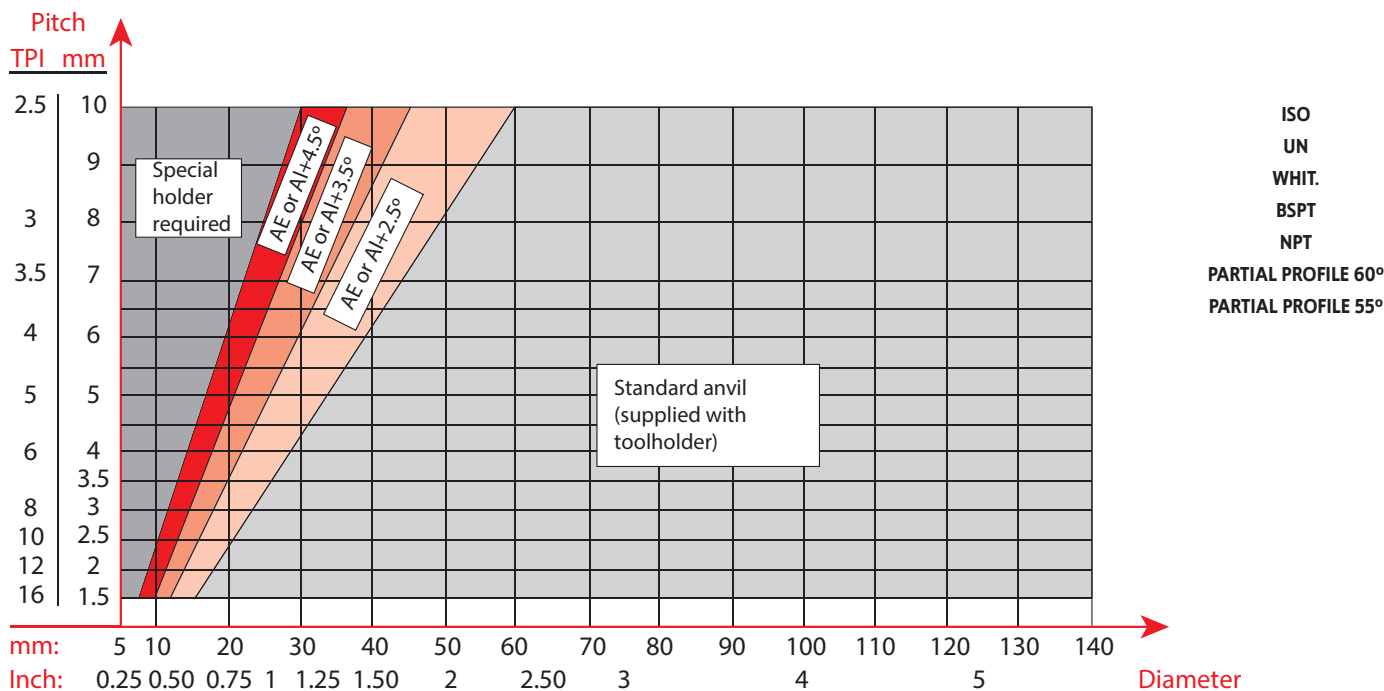

Note: ER=External Right | IR=Internal Right | EL=External Left | IL=Internal Left

The chart below shows that most applications require an anvil change. In most cases a negative anvil is required. Use EA anvils for ER and IL toolholders and IA anvils for IR and EL toolholders.

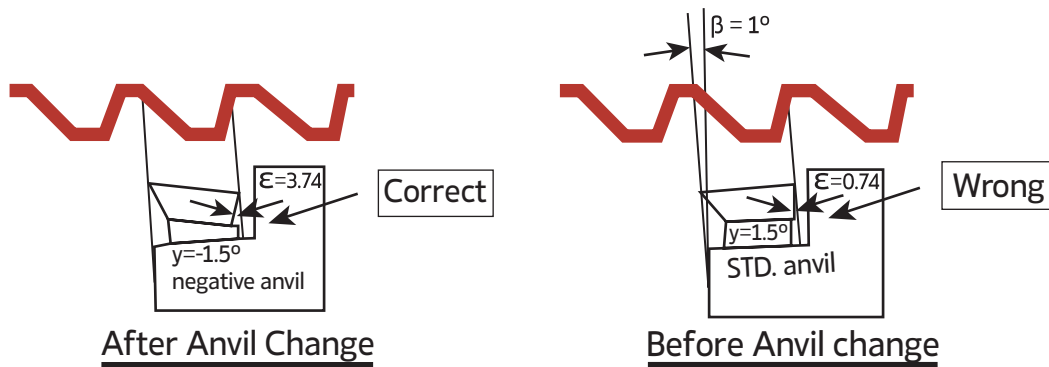
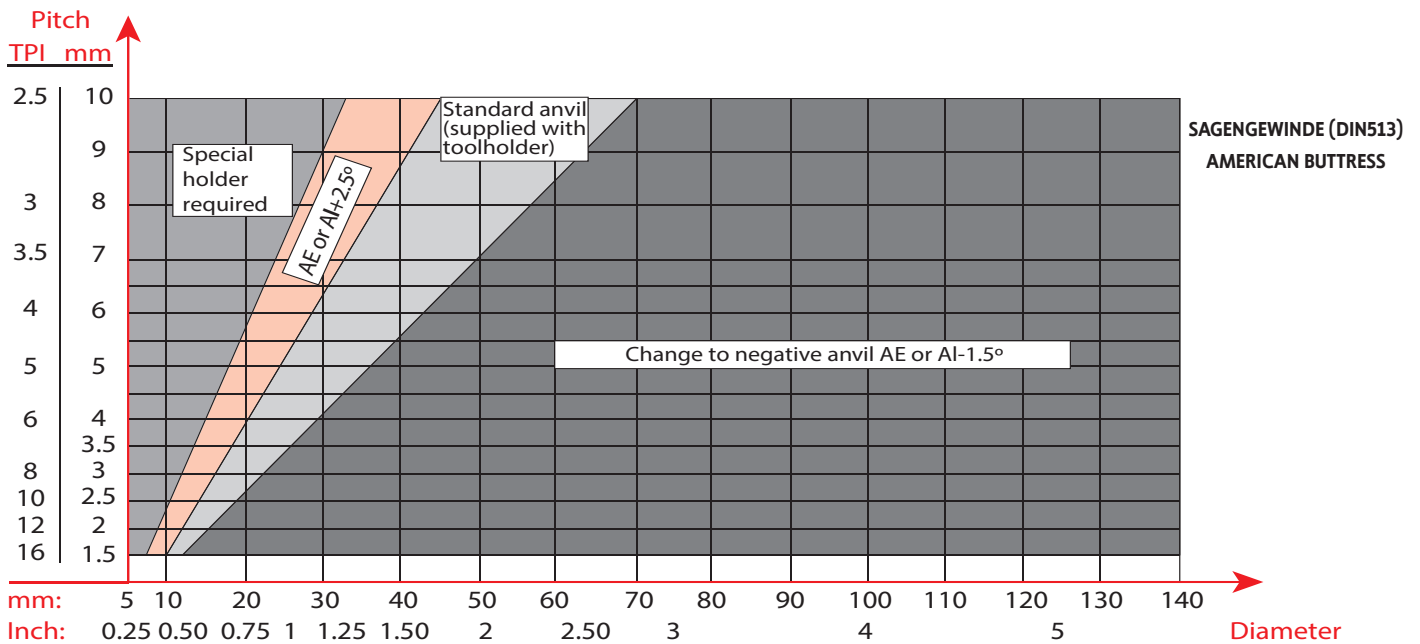

















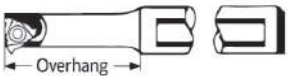

Change from a standard anvil to a negative angle anvil will eliminate the side rubbing.

Note: ER=External Right | IR=Internal Right | EL=External Left | IL=Internal Left

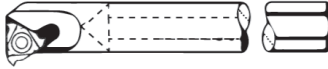
THREADING TECHNICAL DATA

CUTTING CONDITIONS DEPENDS ON | | Condições de corte dependem de | Las condiciones de corte dependen de

Workpiece	Material Type	
	Material Dimension: Diameter and Length	
	Chipflow Character	
	Material Hardness	
Thread Application	External or Internal	
	Profile Shape	
	Surface Finish	
Machine	Machine Stability	
	Max. RPM	
	Clamping System Stability	
Coolant	Coolant Type	
Holders	Holder Cross Section Area	
	Holder Overhang	
	Through Coolant Option	
	Shank Type: Carbide, Alloy, Carbide Implant	
Partial Profile	Grade	
	Profile Shape: Pitch and Depth	
	Nose Radius	
	Chipbreaker Style	

NUMBER OF CUTTING PASSES || Número de passos de corte | Número de pasos de corte

Pitch	MM	0.50	0.75	1.00	1.25	1.50	1.75	2.00	2.50	3.00	3.50	4.00	4.50	5.00	5.50	6.00	8.00
	TPI	48	32	24	20	16	14	12	10	8	7	6	5.5	5	4.5	4	3
No. of Passes		4 - 6	4 - 7	4 - 8	5 - 9	6 - 10	7 - 12	7 - 12	8 - 14	9 - 16	10 - 18	11 - 18	11 - 19	12 - 20	12 - 20	12 - 20	15 - 24

CALCULATE THE N (RPM) || Calcular o N (rpm) | Calcular el N (rpm)

$$N = \frac{1000 \times V_c}{\pi \times D}$$

$$V_c = \frac{N \times \pi \times D}{1000}$$

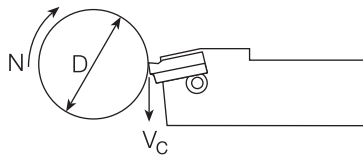

N - Revolution Per Minute [RPM]
 V_c - Cutting Speed [m/min]
 D - Workpiece Diameter [mm]

ANVILS || Colchões | Colchones

Insert Size		Holder Type	Resultant Helix Angle							
IC	L (mm)		4.5	3.5	2.5	1.5 standard	0.5	0	-0.5	-1.5
3/8"	16	ER/IL	EA16 3P	EA16 2P	EA16 1P	EA16	EA16 1N	EA16 1,5N	EA16 2N	EA16 3N
		EL/IR	IA16 3P	IA16 2P	IA16 1P	IA16	IA16 1N	IA16 1,5N	IA16 2N	IA16 3N
1/2"	22	ER/IL	EA22 3P	EA22 2P	EA22 1P	EA22	EA22 1N	EA22 1,5N	EA22 2N	EA22 3N
		EL/IR	IA22 3P	IA22 2P	IA22 1P	IA22	IA22 1N	IA22 1,5N	IA22 2N	IA22 3N
5/8"	27	ER/IL	EA27 3P	EA27 2P	EA27 1P	EA27	EA27 1N	EA27 1,5N	EA27 2N	EA27 3N
		EL/IR	IA27 3P	IA27 2P	IA27 1P	IA27	IA27 1N	IA27 1,5N	IA27 2N	IA27 3N

FLANK CLEARANCE ANGLE - γ

$$\gamma = \text{tg}^{-1}[\text{tg}\alpha \times \text{tg}\delta]$$

$\alpha = 10^\circ$ for external

$\alpha = 15^\circ$ for internal

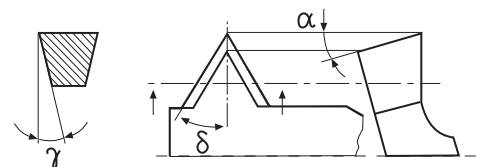

THREADING TECHNICAL DATA - RECOMMENDED N° OF PASSES

ISO METRIC EXTERNAL THREAD

No. of Passes	Pitch (MM)															
	6	5.5	5	4.5	4	3.5	3	2.5	2	1.75	1.5	1.25	1	0.75	0.5	0.35
1	0.45	0.43	0.42	0.39	0.34	0.34	0.27	0.26	0.24	0.23	0.23	0.20	0.19	0.17	0.11	0.10
2	0.37	0.36	0.37	0.33	0.30	0.31	0.23	0.22	0.23	0.21	0.21	0.18	0.16	0.15	0.09	0.08
3	0.33	0.31	0.31	0.29	0.25	0.24	0.20	0.20	0.19	0.16	0.18	0.14	0.13	0.11	0.08	0.06
4	0.28	0.27	0.28	0.25	0.21	0.20	0.18	0.17	0.17	0.14	0.16	0.12	0.10	0.06		
5	0.26	0.25	0.25	0.23	0.19	0.19	0.17	0.16	0.15	0.12	0.11	0.10	0.06			
6	0.24	0.23	0.23	0.20	0.18	0.17	0.16	0.14	0.12	0.10	0.06	0.06				
7	0.23	0.22	0.21	0.19	0.16	0.16	0.15	0.13	0.10	0.08						
8	0.22	0.20	0.20	0.18	0.15	0.15	0.13	0.12	0.06	0.06						
9	0.20	0.19	0.19	0.16	0.15	0.14	0.12	0.10								
10	0.19	0.18	0.18	0.15	0.14	0.12	0.11	0.06								
11	0.18	0.17	0.16	0.14	0.13	0.10	0.09									
12	0.17	0.16	0.14	0.12	0.12	0.06	0.06									
13	0.16	0.15	0.10	0.10	0.10											
14	0.14	0.12	0.06	0.06	0.06											
15	0.13	0.10														
16	0.10	0.06														
17	0.06															
18																
Total	3.71	3.40	3.10	2.79	2.48	2.18	1.87	1.56	1.26	1.10	0.95	0.80	0.64	0.49	0.34	0.24

ISO METRIC INTERNAL THREAD

No. of Passes	Pitch (MM)															
	6	5.5	5	4.5	4	3.5	3	2.5	2	1.75	1.5	1.25	1	0.75	0.5	0.35
1	0.44	0.43	0.42	0.36	0.32	0.32	0.25	0.25	0.23	0.22	0.22	0.19	0.18	0.16	0.10	0.09
2	0.36	0.34	0.37	0.32	0.27	0.29	0.22	0.21	0.21	0.20	0.20	0.16	0.15	0.14	0.09	0.08
3	0.32	0.29	0.28	0.28	0.22	0.23	0.19	0.19	0.18	0.15	0.17	0.13	0.12	0.10	0.07	0.06
4	0.27	0.24	0.26	0.25	0.20	0.19	0.17	0.16	0.16	0.13	0.15	0.11	0.10	0.06	0.06	
5	0.25	0.23	0.24	0.22	0.19	0.18	0.16	0.15	0.14	0.11	0.10	0.10	0.06			
6	0.23	0.22	0.21	0.19	0.18	0.16	0.16	0.13	0.11	0.09	0.06	0.06				
7	0.22	0.21	0.20	0.18	0.16	0.15	0.14	0.12	0.09	0.08						
8	0.21	0.20	0.19	0.17	0.15	0.14	0.12	0.11	0.06	0.06						
9	0.19	0.18	0.18	0.15	0.14	0.13	0.11	0.09								
10	0.17	0.16	0.16	0.14	0.14	0.11	0.10	0.06								
11	0.16	0.16	0.14	0.12	0.12	0.09	0.08									
12	0.15	0.15	0.12	0.10	0.10	0.06	0.06									
13	0.14	0.14	0.09	0.09	0.09											
14	0.13	0.11	0.06	0.06	0.06											
15	0.11	0.09														
16	0.09	0.06														
17	0.06															
18																
Total	3.50	3.21	2.92	2.63	2.34	2.05	1.76	1.47	1.18	1.04	0.90	0.75	0.61	0.46	0.32	0.23

UN EXTERNAL THREAD

No. of Passes	Pitch TPI																		
	4	4.5	5	6	7	8	9	10	11	12	13	14	16	18	20	24	28	32	48
1	0.44	0.43	0.42	0.37	0.33	0.29	0.29	0.26	0.25	0.25	0.24	0.23	0.22	0.21	0.20	0.20	0.18	0.18	0.13
2	0.38	0.35	0.37	0.32	0.28	0.22	0.24	0.22	0.22	0.23	0.22	0.20	0.20	0.19	0.16	0.17	0.15	0.16	0.09
3	0.33	0.30	0.32	0.27	0.23	0.20	0.23	0.20	0.19	0.20	0.18	0.18	0.18	0.17	0.15	0.14	0.11	0.12	0.07
4	0.29	0.28	0.27	0.25	0.22	0.18	0.22	0.17	0.17	0.18	0.16	0.14	0.14	0.16	0.13	0.11	0.09	0.06	0.06
5	0.27	0.26	0.26	0.24	0.21	0.17	0.18	0.16	0.16	0.16	0.14	0.12	0.11	0.11	0.11	0.06	0.06		
6	0.26	0.23	0.24	0.18	0.19	0.16	0.16	0.15	0.15	0.14	0.13	0.11	0.09	0.06	0.06				
7	0.24	0.22	0.22	0.17	0.18	0.16	0.15	0.14	0.13	0.11	0.10	0.10	0.06						
8	0.23	0.21	0.20	0.16	0.15	0.15	0.12	0.12	0.12	0.06	0.06	0.06							
9	0.21	0.20	0.19	0.15	0.14	0.14	0.11	0.11	0.06										
10	0.20	0.19	0.18	0.13	0.14	0.14	0.06	0.06											
11	0.19	0.18	0.17	0.12	0.12	0.11													
12	0.18	0.17	0.14	0.10	0.06	0.06													
13	0.18	0.15	0.11	0.11															
14	0.17	0.14	0.06	0.06															
15	0.16	0.12																	
16	0.13	0.06																	
17	0.06																		
Total	3.92	3.49	3.15	2.63	2.25	1.98	1.76	1.59	1.45	1.33	1.23	1.14	1.00	0.90	0.81	0.68	0.59	0.52	0.35

UN INTERNAL THREAD

No. of Passes	Pitch TPI																		
	4	4.5	5	6	7	8	9	10	11	12	13	14	16	18	20	24	28	32	48
1	0.43	0.43	0.42	0.34	0.31	0.29	0.29	0.25	0.24	0.24	0.23	0.22	0.21	0.20	0.19	0.19	0.17	0.17	0.12
2	0.34	0.35	0.37	0.28	0.27	0.22	0.23	0.21	0.20	0.21	0.21	0.20	0.19	0.18	0.16	0.16	0.14	0.15	0.09
3	0.32	0.29	0.28	0.26	0.22	0.19	0.20	0.19	0.18	0.19	0.17	0.17	0.17	0.16	0.14	0.13	0.10	0.11	0.07
4	0.28	0.24	0.26	0.22	0.20	0.17	0.20	0.16	0.16	0.17	0.15	0.13	0.13	0.15	0.11	0.10	0.08	0.06	0.06
5	0.26	0.23	0.24	0.21	0.19	0.16	0.16	0.15	0.15	0.15	0.13	0.11	0.10	0.09	0.10	0.06	0.06		
6	0.25	0.22	0.21	0.18	0.18	0.16	0.15	0.13	0.14	0.13	0.12	0.10	0.09	0.06	0.06				
7	0.23	0.21	0.20	0.17	0.16	0.14	0.14	0.12	0.12	0.10	0.09	0.09	0.06						
8	0.21	0.20	0.19	0.16	0.15	0.14	0.13	0.12	0.10	0.06	0.06	0.06							
9	0.20	0.19	0.18	0.15	0.14	0.13	0.11	0.11	0.06										
10	0.19	0.18	0.16	0.13	0.14	0.12	0.06	0.06											
11	0.18	0.17	0.16	0.12	0.10	0.08													
12	0.17	0.16	0.13	0.10	0.06	0.06													
13	0.16	0.14	0.10	0.09															
14	0.16	0.12	0.06	0.06															
15	0.14	0.10																	
16	0.12	0.06																	
17	0.06																		
Total	3.70	3.29	2.96	2.47	2.12	1.86	1.67	1.50	1.35	1.25	1.16	1.08	0.95	0.84	0.76	0.64	0.55	0.49	0.34

THREADING TECHNICAL DATA - RECOMMENDED N° OF PASSES

W. EXTERNAL THREAD

No. of Passes	Pitch TPI																		
	4	4.5	5	6	7	8	9	10	11	12	14	16	18	19	20	24	28	32	48
1	0.45	0.44	0.43	0.38	0.34	0.30	0.28	0.27	0.26	0.26	0.24	0.22	0.24	0.22	0.21	0.20	0.18	0.19	0.16
2	0.40	0.36	0.38	0.33	0.29	0.24	0.25	0.23	0.23	0.23	0.21	0.18	0.21	0.19	0.19	0.18	0.15	0.16	0.14
3	0.35	0.31	0.33	0.28	0.24	0.21	0.22	0.21	0.20	0.21	0.17	0.15	0.16	0.17	0.15	0.16	0.12	0.13	0.06
4	0.31	0.29	0.28	0.27	0.23	0.19	0.21	0.18	0.18	0.19	0.15	0.13	0.15	0.14	0.13	0.11	0.10	0.06	
5	0.28	0.27	0.27	0.25	0.22	0.18	0.20	0.17	0.17	0.17	0.14	0.12	0.11	0.11	0.10	0.06	0.06		
6	0.27	0.24	0.25	0.19	0.20	0.17	0.17	0.16	0.16	0.15	0.12	0.10	0.06	0.06	0.06				
7	0.25	0.23	0.23	0.18	0.19	0.17	0.17	0.14	0.13	0.12	0.10	0.09							
8	0.24	0.22	0.21	0.17	0.16	0.16	0.15	0.13	0.12	0.06	0.06	0.06							
9	0.22	0.21	0.20	0.16	0.15	0.14	0.13	0.11	0.06										
10	0.21	0.20	0.19	0.14	0.15	0.13	0.06	0.06											
11	0.20	0.19	0.18	0.12	0.12	0.11													
12	0.19	0.18	0.15	0.10	0.06	0.06													
13	0.18	0.16	0.12	0.11															
14	0.18	0.15	0.06	0.06															
15	0.17	0.13																	
16	0.13	0.06																	
17	0.06																		
Total	4.09	3.64	3.28	2.74	2.35	2.06	1.84	1.66	1.51	1.39	1.19	1.05	0.93	0.89	0.84	0.71	0.61	0.54	0.36

W. INTERNAL THREAD

No. of Passes	Pitch TPI																		
	4	4.5	5	6	7	8	9	10	11	12	14	16	18	19	20	24	28	32	48
1	0.45	0.44	0.43	0.38	0.34	0.30	0.28	0.27	0.26	0.26	0.24	0.22	0.24	0.22	0.21	0.20	0.18	0.19	0.16
2	0.40	0.36	0.38	0.33	0.29	0.24	0.25	0.23	0.23	0.23	0.21	0.18	0.21	0.19	0.19	0.18	0.15	0.16	0.14
3	0.35	0.31	0.33	0.28	0.24	0.21	0.22	0.21	0.20	0.21	0.17	0.15	0.16	0.17	0.15	0.16	0.12	0.13	0.06
4	0.31	0.29	0.28	0.27	0.23	0.19	0.21	0.18	0.18	0.19	0.15	0.13	0.15	0.14	0.13	0.11	0.10	0.06	
5	0.28	0.27	0.27	0.25	0.22	0.18	0.20	0.17	0.17	0.17	0.14	0.12	0.11	0.11	0.10	0.06	0.06		
6	0.27	0.24	0.25	0.19	0.20	0.17	0.17	0.16	0.16	0.15	0.12	0.10	0.06	0.06	0.06				
7	0.25	0.23	0.23	0.18	0.19	0.17	0.17	0.14	0.13	0.12	0.10	0.09							
8	0.24	0.22	0.21	0.17	0.16	0.16	0.15	0.13	0.12	0.06	0.06	0.06							
9	0.22	0.21	0.20	0.16	0.15	0.14	0.13	0.11	0.06										
10	0.21	0.20	0.19	0.14	0.15	0.13	0.06	0.06											
11	0.20	0.19	0.18	0.12	0.12	0.11													
12	0.19	0.18	0.15	0.10	0.06	0.06													
13	0.18	0.16	0.12	0.11															
14	0.18	0.15	0.06	0.06															
15	0.17	0.13																	
16	0.13	0.06																	
17	0.06																		
Total	4.09	3.64	3.28	2.74	2.35	2.06	1.84	1.66	1.51	1.39	1.19	1.05	0.93	0.89	0.84	0.71	0.61	0.54	0.36

NPT EXTERNAL & INTERNAL

No. of Passes	Pitch TPI				
	4	11.5	14	18	27
1	0.32	0.23	0.22	0.18	0.14
2	0.25	0.19	0.18	0.15	0.11
3	0.21	0.17	0.15	0.13	0.11
4	0.17	0.16	0.14	0.13	0.10
5	0.16	0.15	0.13	0.12	0.09
6	0.16	0.13	0.12	0.11	0.08
7	0.15	0.12	0.10	0.09	0.06
8	0.15	0.10	0.10	0.08	
9	0.14	0.10	0.09	0.06	
10	0.13	0.10	0.08		
11	0.13	0.09	0.06		
12	0.12	0.08			
13	0.12	0.06			
14	0.10				
15	0.08				
16	0.06				
Total	2.45	1.68	1.37	1.05	0.69

NPTF EXTERNAL & INTERNAL

No. of Passes	Pitch TPI				
	8	11.5	14	18	27
1	0.31	0.22	0.21	0.17	0.14
2	0.24	0.17	0.17	0.14	0.10
3	0.20	0.16	0.14	0.13	0.09
4	0.16	0.16	0.14	0.12	0.09
5	0.16	0.14	0.14	0.11	0.08
6	0.15	0.13	0.12	0.10	0.08
7	0.15	0.12	0.10	0.09	0.06
8	0.14	0.11	0.10	0.08	
9	0.14	0.10	0.09	0.06	
10	0.13	0.10	0.08		
11	0.13	0.09	0.06		
12	0.12	0.08			
13	0.12	0.06			
14	0.10				
15	0.08				
16	0.06				
Total	2.39	1.64	1.35	1.00	0.64

TR EXTERNAL & INTERNAL

No. of Passes	Pitch (MM)						
	7.0	6.0	5.0	4.0	3.0	2.0	1.5
1	0.38	0.36	0.34	0.32	0.31	0.30	0.24
2	0.34	0.32	0.30	0.28	0.26	0.26	0.22
3	0.28	0.28	0.25	0.23	0.23	0.22	0.17
4	0.26	0.25	0.23	0.20	0.19	0.18	0.14
5	0.25	0.24	0.22	0.19	0.19	0.16	0.12
6	0.23	0.23	0.21	0.18	0.18	0.12	0.06
7	0.22	0.22	0.19	0.17	0.15	0.06	
8	0.21	0.20	0.18	0.16	0.12		
9	0.20	0.19	0.17	0.15	0.11		
10	0.19	0.17	0.16	0.14	0.06		
11	0.19	0.16	0.14	0.12			
12	0.18	0.15	0.13	0.10			
13	0.18	0.13	0.12	0.06			
14	0.16	0.13	0.10				
15	0.16	0.12	0.06				
16	0.15	0.12					
17	0.15	0.11					
18	0.14	0.11					
19	0.12	0.06					
20	0.06						
Total	4.05	3.55	2.80	2.30	1.80	1.30	0.95

Technical Data
 Thread turning - Spare Parts
 Thread turning - Toolholders
 Thread turning - Inserts
 Thread turning - Overview
 Thread milling - Toolholders
 Thread milling - Inserts
 THREADING

THREADING TECHNICAL DATA - RECOMMENDED N° OF PASSES

ACME EXTERNAL & INTERNAL

No. of Passes	Pitch TPI							
	4	5	6	8	10	12	14	16
1	0.36	0.34	0.31	0.27	0.26	0.26	0.25	0.24
2	0.32	0.30	0.29	0.23	0.23	0.22	0.21	0.22
3	0.28	0.25	0.25	0.19	0.20	0.18	0.18	0.18
4	0.25	0.23	0.21	0.18	0.19	0.16	0.15	0.15
5	0.24	0.22	0.18	0.17	0.16	0.14	0.13	0.12
6	0.23	0.21	0.17	0.16	0.14	0.12	0.10	0.06
7	0.22	0.19	0.16	0.15	0.12	0.10	0.06	
8	0.20	0.19	0.15	0.14	0.11	0.06		
9	0.19	0.18	0.15	0.12	0.10			
10	0.17	0.17	0.14	0.12	0.06			
11	0.15	0.15	0.13	0.10				
12	0.14	0.13	0.12	0.06				
13	0.13	0.12	0.10					
14	0.12	0.10	0.06					
15	0.11	0.06						
16	0.11							
17	0.10							
18	0.10							
19	0.06							
Total	3.48	2.84	2.42	1.89	1.57	1.24	1.08	0.97

STUB ACME EXTERNAL & INTERNAL

No. of Passes	Pitch TPI							
	4	5	6	8	10	12	14	16
1	0.31	0.30	0.27	0.23	0.23	0.22	0.21	0.18
2	0.26	0.26	0.23	0.19	0.17	0.17	0.18	0.16
3	0.21	0.21	0.20	0.16	0.14	0.14	0.15	0.13
4	0.19	0.18	0.16	0.15	0.13	0.12	0.12	0.12
5	0.17	0.16	0.15	0.13	0.12	0.10	0.06	0.06
6	0.17	0.15	0.14	0.12	0.11	0.06		
7	0.16	0.15	0.13	0.11	0.10			
8	0.15	0.13	0.12	0.10	0.06			
9	0.15	0.12	0.10	0.06				
10	0.14	0.10	0.06					
11	0.13	0.06						
12	0.11							
13	0.06							
Total	2.21	1.82	1.56	1.25	1.06	0.81	0.72	0.65

UNJ EXTERNAL THREAD

No. of Passes	Pitch TPI												
	8	9	10	11	12	13	14	16	18	20	24	28	32
1	0.29	0.29	0.26	0.25	0.25	0.24	0.23	0.22	0.21	0.20	0.20	0.18	0.18
2	0.22	0.24	0.22	0.22	0.23	0.22	0.20	0.20	0.19	0.16	0.17	0.14	0.15
3	0.20	0.22	0.19	0.19	0.19	0.18	0.17	0.17	0.16	0.14	0.13	0.10	0.11
4	0.18	0.20	0.17	0.16	0.17	0.15	0.14	0.13	0.15	0.12	0.10	0.09	0.06
5	0.16	0.17	0.15	0.15	0.15	0.13	0.11	0.10	0.10	0.10	0.06	0.06	
6	0.16	0.16	0.14	0.14	0.13	0.12	0.10	0.09	0.06	0.06			
7	0.15	0.14	0.13	0.12	0.10	0.09	0.09	0.06					
8	0.14	0.12	0.11	0.11	0.06	0.06	0.06						
9	0.13	0.10	0.10	0.06									
10	0.12	0.06	0.06										
11	0.10												
12	0.06												
Total	1.91	1.70	1.53	1.40	1.28	1.19	1.10	0.97	0.87	0.78	0.66	0.57	0.50

UNJ INTERNAL THREAD

No. of Passes	Pitch TPI												
	8	9	10	11	12	13	14	16	18	20	24	28	32
1	0.29	0.29	0.26	0.25	0.25	0.24	0.23	0.22	0.21	0.20	0.20	0.18	0.18
2	0.22	0.24	0.22	0.22	0.23	0.22	0.20	0.20	0.19	0.16	0.17	0.14	0.15
3	0.20	0.22	0.19	0.19	0.19	0.18	0.17	0.17	0.16	0.14	0.13	0.10	0.11
4	0.18	0.20	0.17	0.16	0.17	0.15	0.14	0.13	0.15	0.12	0.10	0.09	0.06
5	0.16	0.17	0.15	0.15	0.15	0.13	0.11	0.10	0.10	0.10	0.06	0.06	
6	0.16	0.16	0.14	0.14	0.13	0.12	0.10	0.09	0.06	0.06			
7	0.15	0.14	0.13	0.12	0.10	0.09	0.09	0.06					
8	0.14	0.12	0.11	0.11	0.06	0.06	0.06						
9	0.13	0.10	0.10	0.06									
10	0.12	0.06	0.06										
11	0.10												
12	0.06												
Total	1.91	1.70	1.53	1.40	1.28	1.19	1.10	0.97	0.87	0.78	0.66	0.57	0.50

THREADING TECHNICAL DATA - RECOMMENDED N° OF PASSES

MJ INTERNAL THREAD

No. of Passes	Pitch (MM)					
	1.0	1.25	1.5	2.0	2.5	3.0
1	0.16	0.17	0.22	0.23	0.24	0.24
2	0.13	0.14	0.19	0.21	0.21	0.20
3	0.11	0.12	0.14	0.18	0.18	0.18
4	0.09	0.10	0.11	0.16	0.16	0.17
5	0.06	0.09	0.09	0.14	0.14	0.16
6		0.06	0.06	0.10	0.13	0.15
7				0.06	0.12	0.13
8					0.10	0.12
9					0.06	0.10
10						0.09
11						0.06
12						
Total	0.55	0.68	0.81	1.08	1.34	1.60

MJ EXTERNAL THREAD

No. of Passes	Pitch (MM)					
	1.0	1.25	1.5	2.0	2.5	3.0
1	0.18	0.18	0.22	0.23	0.25	0.26
2	0.15	0.16	0.20	0.22	0.21	0.22
3	0.13	0.14	0.18	0.18	0.19	0.19
4	0.10	0.12	0.15	0.16	0.16	0.17
5	0.06	0.10	0.11	0.14	0.15	0.16
6		0.06	0.06	0.12	0.14	0.15
7				0.10	0.13	0.14
8				0.06	0.12	0.13
9					0.10	0.12
10					0.06	0.11
11						0.09
12						0.06
Total	0.62	0.76	0.92	1.21	1.51	1.80

RD (DIN 20400) EXTERNAL & INTERNAL THREAD

No. of Passes	Pitch (MM)			
	6.0	5.0	4.0	3.0
1	0.35	0.32	0.25	0.24
2	0.33	0.28	0.24	0.23
3	0.32	0.27	0.23	0.21
4	0.31	0.26	0.22	0.20
5	0.30	0.25	0.21	0.19
6	0.29	0.24	0.20	0.18
7	0.26	0.22	0.19	0.14
8	0.23	0.20	0.18	0.11
9	0.22	0.19	0.16	0.10
10	0.19	0.16	0.14	0.09
11	0.17	0.15	0.12	0.06
12	0.15	0.13	0.10	
13	0.12	0.12	0.06	
14	0.10	0.06		
15	0.06			
Total	3.40	2.85	2.30	1.75

RD (DIN 405) EXTERNAL & INTERNAL THREAD

No. of Passes	Pitch TPI			
	4	6	8	10
1	0.35	0.25	0.24	0.23
2	0.32	0.24	0.22	0.21
3	0.31	0.22	0.20	0.19
4	0.30	0.21	0.19	0.18
5	0.29	0.20	0.18	0.16
6	0.28	0.19	0.16	0.14
7	0.25	0.18	0.14	0.11
8	0.22	0.16	0.11	0.09
9	0.21	0.15	0.10	0.06
10	0.18	0.13	0.09	
11	0.16	0.12	0.06	
12	0.13	0.11		
13	0.12	0.06		
14	0.10			
15	0.06			
Total	3.28	2.22	1.69	1.37

PG INTERNAL & EXTERNAL

No. of Passes	Pitch TPI		
	20	18	16
1	0.17	0.18	0.19
2	0.15	0.14	0.16
3	0.14	0.12	0.13
4	0.10	0.10	0.11
5	0.06	0.09	0.10
6		0.06	0.09
7			0.06
Total	0.62	0.69	0.78

AMERICAN BUTTRESS EXTERNAL & INTERNAL

No. of Passes	Pitch TPI					
	6	8	10	12	16	20
1	0.28	0.25	0.22	0.21	0.20	0.18
2	0.24	0.22	0.20	0.19	0.18	0.16
3	0.21	0.19	0.19	0.18	0.17	0.14
4	0.20	0.19	0.17	0.16	0.14	0.13
5	0.20	0.17	0.16	0.15	0.13	0.12
6	0.19	0.16	0.15	0.14	0.12	0.10
7	0.19	0.16	0.13	0.13	0.10	0.06
8	0.18	0.15	0.12	0.12	0.06	
9	0.17	0.14	0.12	0.11		
10	0.16	0.13	0.11	0.06		
11	0.15	0.12	0.10			
12	0.14	0.11	0.06			
13	0.14	0.10				
14	0.13	0.06				
15	0.12					
16	0.10					
17	0.06					
Total	2.86	2.15	1.73	1.45	1.10	0.89

THREADING TECHNICAL DATA - RECOMMENDED N° OF PASSES

SAGENGWINDE (DIN 513) EXTERNAL

No. of Passes	Pitch (MM)		
	4.0	3.0	2.0
1	0.32	0.30	0.29
2	0.30	0.28	0.26
3	0.27	0.26	0.24
4	0.25	0.24	0.19
5	0.23	0.22	0.18
6	0.21	0.21	0.17
7	0.20	0.20	0.15
8	0.19	0.18	0.14
9	0.18	0.17	0.11
10	0.17	0.15	0.06
11	0.16	0.14	
12	0.15	0.13	
13	0.15	0.11	
14	0.15	0.06	
15	0.14		
16	0.14		
17	0.13		
18	0.12		
19	0.06		
Total	3.52	2.65	1.79

SAGENGWINDE (DIN 513) INTERNAL

No. of Passes	Pitch (MM)		
	4.0	3.0	2.0
1	0.32	0.31	0.29
2	0.30	0.29	0.27
3	0.27	0.27	0.25
4	0.24	0.24	0.21
5	0.23	0.23	0.18
6	0.21	0.22	0.16
7	0.20	0.20	0.12
8	0.19	0.19	0.06
9	0.18	0.16	
10	0.17	0.13	
11	0.16	0.06	
12	0.15		
13	0.14		
14	0.13		
15	0.10		
16	0.06		
Total	3.05	2.30	1.54

API EXTERNAL & INTERNAL

No. of Passes	VO.038R 4 TPI		VO.050 4 TPI		VO.040 5 TPI	Buttress casing 5 TPI	
	2 IPF	3 IPF	2 IPF	3 IPF	3 IPF	0.75 IPF	1.0 IPF
1	0.45	0.45	0.44	0.44	0.41	0.24	0.24
2	0.38	0.38	0.39	0.39	0.36	0.22	0.22
3	0.33	0.33	0.34	0.34	0.32	0.18	0.18
4	0.30	0.30	0.31	0.31	0.28	0.14	0.14
5	0.28	0.28	0.28	0.28	0.26	0.12	0.12
6	0.24	0.24	0.26	0.26	0.24	0.12	0.12
7	0.22	0.22	0.24	0.24	0.22	0.12	0.12
8	0.20	0.20	0.23	0.23	0.20	0.10	0.10
9	0.18	0.18	0.21	0.21	0.18	0.10	0.10
10	0.14	0.14	0.19	0.19	0.14	0.10	0.10
11	0.13	0.13	0.18	0.18	0.13	0.10	0.10
12	0.12	0.12	0.16	0.16	0.12	0.06	0.06
13	0.11	0.10	0.14	0.14	0.11		
14	0.06	0.06	0.13	0.13	0.06		
15			0.12	0.12			
16			0.10	0.11			
17			0.06	0.06			
Total	3.14	3.13	3.79	3.78	3.03	1.60	1.60

API EXTERNAL & INTERNAL

No. of Passes	Extreme Line Casing 6 TPI 1.5 IPF		Extreme Line Casing 5 TPI 1.5 IPF		Round API 0.75 IPF 8 TPI		Round API 0.75 IPF 10 TPI	
	External	Internal	External	Internal	External	Internal	External	Internal
1	0.23	0.25	0.25	0.25	0.25	0.25	0.25	0.25
2	0.20	0.20	0.22	0.23	0.22	0.22	0.20	0.20
3	0.16	0.17	0.20	0.21	0.20	0.20	0.17	0.17
4	0.15	0.15	0.18	0.19	0.18	0.18	0.15	0.15
5	0.13	0.14	0.15	0.16	0.16	0.16	0.14	0.14
6	0.12	0.13	0.14	0.15	0.15	0.15	0.13	0.13
7	0.11	0.12	0.13	0.14	0.14	0.14	0.12	0.12
8	0.10	0.12	0.12	0.13	0.13	0.13	0.12	0.12
9	0.06	0.10	0.11	0.12	0.12	0.12	0.10	0.10
10		0.06	0.10	0.11	0.11	0.11	0.06	0.06
11			0.10	0.11	0.11	0.11		
12			0.06	0.10	0.06	0.06		
13				0.06				
Total	1.26	1.44	1.76	1.96	1.83	1.83	1.44	1.44

THREADING TECHNICAL DATA

TAPER PIPE THREAD: NPT / ANSI/ASME B 1.20.1-1983 - INTERNAL THREAD AMERICAN NATIONAL STANDARD TAPER PIPE THREADS

Thread Size				Recommended Tools	
	Pitch TPI	Pitch MM	Profile Depth	Insert	Toolholder
NPT 1/16	27	0.941	0.69	06IR 27NPT	S12H SXFNR 06
NPT 1/8	27	0.941	0.69	08IR 27NPT	S16K SXFNR 08
NPT 1/4	18	1,411	1.05	08IR 18NPT	S16K SXFNR 08
NPT 3/8	18	1,411	1.05	11IR 18NPT	S10K SXFNR 11
NPT 1/2	14	1,814	1.37	16IR 14NPT	S13M SXFNR 16
NPT 3/4	14	1,814	1.37	16IR 14NPT	S16P SXFNR 16
NPT 1	11.5	2,209	1.68	16IR 11.5NPT	S20P SXFNR 16
NPT 1 1/4	11.5	2,209	1.68	16IR 11.5NPT	S25R SXFNR 16
NPT 1 1/2	11.5	2,209	1.68	16IR 11.5NPT	S32S SXFNR 16
NPT 2	11.5	2,209	1.68	16IR 11.5NPT	S32S SXFNR 16
NPT 2 1/2	8	3,175	2.45	16IR 8NPT	S40T SXFNR 16
NPT 3	8	3,175	2.45	16IR 8NPT	S40T SXFNR 16
NPT 3 1/2	8	3,175	2.45	16IR 8NPT	S40T SXFNR 16
NPT 4	8	3,175	2.45	16IR 8NPT	S40T SXFNR 16
NPT 5	8	3,175	2.45	16IR 8NPT	S40T SXFNR 16

TAPER PIPE THREAD: NPTF / ANSI B 1.20.3-1976 - INTERNAL THREAD AMERICAN NATIONAL STANDARD DRYSEAL PIPE THREADS

Thread Size				Recommended Tools	
	Pitch TPI	Pitch MM	Profile Depth	Insert	Toolholder
NPTF 1/16	27	0.941	0.64	06IR 27NPTF	S12H SXFNR 06
NPTF 1/8	27	0.941	0.64	08IR 27NPTF	S16K SXFNR 08
NPTF 1/4	18	1,411	1.00	08IR 18NPTF	S16K SXFNR 08
NPTF 3/8	18	1,411	1.00	11IR 18NPTF	S10K SXFNR 11
NPTF 1/2	14	1,814	1.35	16IR 14NPTF	S13M SXFNR 16
NPTF 3/4	14	1,814	1.35	16IR 14NPTF	S16P SXFNR 16
NPTF 1	11.5	2,209	1.64	16IR 11.5NPTF	S20P SXFNR 16
NPTF 1 1/4	11.5	2,209	1.64	16IR 11.5NPTF	S25R SXFNR 16
NPTF 1 1/2	11.5	2,209	1.64	16IR 11.5NPTF	S32S SXFNR 16
NPTF 2	11.5	2,209	1.64	16IR 11.5NPTF	S32S SXFNR 16
NPTF 2 1/2	8	3,175	2.39	16IR 08NPTF	S40T SXFNR 16
NPTF 3	8	3,175	2.39	16IR 08NPTF	S40T SXFNR 16

PARALLEL PIPE THREAD / BSP (G) - INTERNAL THREAD

Thread Size					Recommended Tools	
	Pitch TPI	Pitch MM	Profile Depth	Bore Diameter	Insert	Toolholder
G1/16	28	0.907	0.581	6,561	06IR 28W	S12H SXFNR 06
G1/8	28	0.907	0.581	8,556	08IR 28W	S16K SXFNR 08
G1/4	19	1,337	0.856	11,445	08IR 19W	S16K SXFNR 08
G3/8	19	1,337	0.856	14,950	11IR 19W	S10K SXFNR 11
G1/2	14	1,814	1,162	18,631	16IR 14W	S13M SXFNR 16
G5/8	14	1,814	1,162	20,587	16IR 14W	S16P SXFNR 16
G3/4	14	1,814	1,162	24,117	16IR 14W	S16P SXFNR 16
G7/8	11	1,814	1,162	27,877	16IR 14W	S20P SXFNR 16
G1	11	2,309	1,479	30,291	16IR 11W	S20P SXFNR 16
G1 1/8	11	2,309	1,479	34,939	16IR 11W	S25R SXFNR 16
G1 1/4	11	2,309	1,479	38,952	16IR 11W	S25R SXFNR 16
G1 1/2	11	2,309	1,479	44,845	16IR 11W	S32S SXFNR 16
G1 3/4	11	2,309	1,479	50,788	16IR 11W	S32S SXFNR 16
G2	11	2,309	1,479	56,656	16IR 11W	S32S SXFNR 16

TAPER PIPE THREAD / B SPT (RC) - INTERNAL THREAD

Thread Size					Recommended Tools	
	Pitch TPI	Pitch MM	Profile Depth	Bore Diameter	Insert	Toolholder
Rc 1/16	28	0.907	0.581	6,561	06IR 28BSPT	S12H SXFNR 06
Rc 1/8	28	0.907	0.581	8,556	08IR 28BSPT	S16K SXFNR 08
Rc 1/4	19	1,337	0.856	11,445	08IR 19BSPT	S16K SXFNR 08
Rc 3/8	19	1,337	0.856	14,950	11IR 19BSPT	S10K SXFNR 11
Rc 1/2	14	1,814	1,162	18,631	16IR 14BSPT	S13M SXFNR 16
Rc 5/8	14	1,814	1,162	20,587	16IR 14BSPT	S16P SXFNR 16
Rc 3/4	14	1,814	1,162	24,117	16IR 14BSPT	S16P SXFNR 16
Rc 7/8	14	1,814	1,162	27,877	16IR 14BSPT	S20P SXFNR 16
Rc 1	11	2,309	1,479	30,291	16IR 11BSPT	S20P SXFNR 16
Rc 1 1/8	11	2,309	1,479	34,939	16IR 11BSPT	S25R SXFNR 16
Rc 1 1/4	11	2,309	1,479	38,952	16IR 11BSPT	S25R SXFNR 16
Rc 1 1/2	11	2,309	1,479	44,845	16IR 11BSPT	S32S SXFNR 16
Rc 1 3/4	11	2,309	1,479	50,788	16IR 11BSPT	S32S SXFNR 16
Rc 2	11	2,309	1,479	56,656	16IR 11BSPT	S32S SXFNR 16

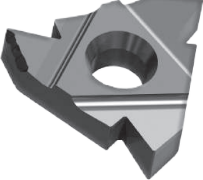
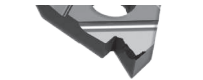
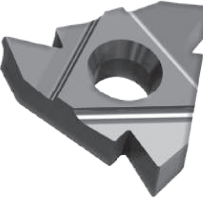
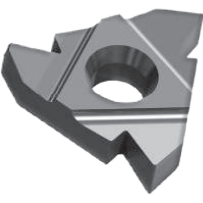
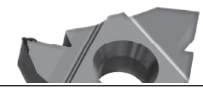
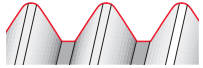
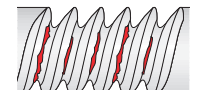
Problem Problema	Possible Cause Causa Possível Causa Posible	Solution Solução Solución
<p>Increased flank wear Desgaste da aresta Desgaste del flanco</p> 	<ul style="list-style-type: none"> • Cutting speed too high • Velocidade de corte alta • Alta velocidad de corte • Depth of cut too low/ too many passes • Profundidade de corte demasiado baixa / demasiados passos • Profundidad de corte demasiado baja / demasiados pasos • Unsuitable carbide grade • Grau desajustado • Grado desajustado • Insufficient cooling • Refrigeração insuficiente • Insuficiente refrigeración 	<ul style="list-style-type: none"> • Reduce cutting speed / Use coated insert • Reduza a velocidade de corte / Use uma pastilha revestida • Reducir la velocidad de corte / Utilice un inserto recubierto • Increase the depth of cut per pass • Aumente a profundidade de corte por passo • Aumento de la profundidad de corte por paso • Use a coated carbide grade • Use um grau revestido • Utilice un grado recubierto • Increase coolant flow rate • Aumente o fluxo de refrigeração • Aumentar el flujo de refrigeración
<p>Uneven cutting edge wear Deformação da aresta de corte Deformación del flanco de corte</p> 	<ul style="list-style-type: none"> • Incorrect helix angle • Ângulo da hélice incorrecto • Ángulo de hélice incorrecta • Wrong infeed method • Método de avanço incorrecto • Método incorrecto de avance 	<ul style="list-style-type: none"> • Choose the correct anvil • Escolha o ângulo correcto • Elija el ángulo correcto • Use the Alternating Flank Infeed method • Use um método alternativo de avanço • Utilizar un método alternativo de avance
<p>Extreme plastic deformation Deformação plástica extrema Deformación plástica extrema</p> 	<ul style="list-style-type: none"> • Depth of cut too large • Profundidade de corte demasiado larga • Profundidad de corte demasiado grande • Insufficient cooling • Refrigeração insuficiente • Insuficiente refrigeración • Cutting speed too high • Velocidade de corte alta • Alta velocidad de corte • Unsuitable carbide grade • Grau não aconselhável • Grado no es aconsejable • Nose radius too small • Raio demasiado pequeno • Radio demasiado pequeño 	<ul style="list-style-type: none"> • Decrease depth of cut / Increase number of passes • Diminua a profundidade de corte / Aumente o número de passos • Reducir la profundidad de corte / Aumentar el número de pasos • Increase coolant flow rate • Aumente o fluxo de refrigeração • Aumentar el flujo de refrigeración • Reduce cutting speed • Reduza a velocidade de corte • Reducir la velocidad de corte • Use a tougher carbide • Use um grau mais macio • Usar un grado más suave • Use an insert with a larger radius, if possible • Use uma pastilha com um raio mais largo, se possível • Utilice un inserto con un radio más amplio, si es posible
<p>Cutting edge breakage Quebra da aresta de corte Rotura del flanco de corte</p> 	<ul style="list-style-type: none"> • Depth of cut too large • Profundidade de corte demasiado larga • Profundidad de corte demasiado grande • Extreme plastic deformation • Deformação plástica extrema • Deformación plástica extrema • Insufficient cooling • Refrigeração insuficiente • Insuficiente refrigeración • Unsuitable carbide grade • Grau não aconselhável • Grado no es aconsejable • Instability • Instabilidade • Inestabilidad 	<ul style="list-style-type: none"> • Decrease depth of cut / Increase number of passes • Diminua a profundidade de corte / Aumente o número de passos • Reducir la profundidad de corte / Aumentar el número de pasos • Use a tougher carbide • Use um grau mais macio • Usar un grado más suave • Increase flow rate and/ or correct flow direction • Aumento o fluxo ou melhore o direcionamento da refrigeração • Aumentar o mejorar la dirección del flujo de la refrigeración • Use a tougher carbide • Use um grau mais macio • Usar un grado más suave • Check stability of the system • Verifique a estabilidade do sistema • Compruebe la estabilidad del sistema
<p>Built-up edge Aresta postica Filos recrescidos</p> 	<ul style="list-style-type: none"> • Incorrect cutting speed • Velocidade de corte incorrecta • Velocidad de corte incorrecta • Unsuitable carbide grade • Grau não aconselhável • Grado no es aconsejable 	<ul style="list-style-type: none"> • Change the cutting speed • Altere a velocidade de corte • Cambiar la velocidad de corte • Use a coated carbide • Utilize um grau revestido • Utilice un grado recubierto
<p>Thread profile is too shallow Perfil da rosca muito irregular Perfil de la rosca muy irregular</p> 	<ul style="list-style-type: none"> • The tool is not at the workpiece axis height • A pastilha não está a maquinar a crista da rosca • El inserto no está mecanizando • Insert is not machining the thread crest • A ferramenta não está posicionada correctamente • La herramienta no está colocada correctamente a cresta de la rosca • Worn insert • Pastilha gasta • Inserto pasado 	<ul style="list-style-type: none"> • Change tool height • Altere o posicionamento em altura da ferramenta • Cambiar la posición en la altura de la herramienta • Measure the workpiece diameter • Medir o diâmetro correcto da peça de trabalho • Medir el diámetro de la pieza de trabajo • Change the cutting edge sooner • Mudar antecipadamente a aresta de corte • Cambiar el flanco de corte en anticipo
<p>Thread profile is too shallow Má qualidade superfície Acabado de superficie malo</p> 	<ul style="list-style-type: none"> • Cutting speed too low • Velocidade de corte baixa • Velocidad de corte baja • Wrong anvil • Colchão errado • Colchón cambiado • Flank infeed method is not appropriate • Posição de avanço inapropriada • Posición de avance inadecuada 	<ul style="list-style-type: none"> • Increase cutting speed • Aumente a velocidade de corte • Aumentar la velocidad de corte • Choose correct anvil • Escolha um colchão mais apropriado • Elija un colchón más apropiado • Use the alternate flank or radial infeed method • Use um método de flanqueamento ou radial alternativo • Utilice un método flanqueamento o radial alternativo

WORKPIECE MATERIALS = PALBIT SELECTION MATERIALS, PSM

Material da peça - seleção de materiais Palbit, PSM | Material de la pieza - selección materiales Palbit, PSM

Steel, Ferritic and Martensitic Stainless Steel

ISO	PSM	Material Example	Description	R _m (N/mm ²)	kcX (N/mm ²)	m _c
P	1	Ck50	Structural steels; ordinary carbon steels with low to medium carbon content(<0,5%C); soft carbon steel; free cutting steel.	<500	1500	0.25
	2	42CrMnNiMo 4	Normal tool steels; harder steels for toughening; Martensitic stainless steels; Carbon steels with high carbon content (>0,5%C); Ferritic and martensitic stainless steels.	550<900	1900	0.24
	3	X40CrMoV51	Normal tool steels; Harder steels for toughening; Martensitic stainless steels; Difficult tool steels; High-alloy steels with high hardness; Martensitic stainless steels.	900<1200	2000	0.24

Easy-cutting, Austenitic and Duplex Stainless Steel

ISO	PSM	Material Example	Description	R _m (N/mm ²)	kcX (N/mm ²)	m _c
M	4	X8CrNiS189	Easy-cutting stainless steels; Free-cutting stainless steels; Calcium-treated stainless steels.		1750	0.22
	5	X2CrNiMo17122	Moderately to difficult stainless steels: Austenitic and duplex.		2050	0.20
	6	X2CrNiMoN2253	Very difficult stainless steels: Austenitic and duplex.		2150	0.20

Cast Iron

ISO	PSM	Material Example	Description	R _m (N/mm ²)	kcX (N/mm ²)	m _c
K	7	GJL-150	Medium / hard cast iron; Grey cast iron.		1150	0.22
	8	GJL-250	Low-alloy cast iron; Malleable cast iron; Nodular cast iron.		1225	0.25
	9	GJL-350	Difficult high-alloy cast iron; Difficult malleable cast iron; Nodular cast iron		1470	0.30

Aluminium and Non-Ferrous

ISO	PSM	Material Example	Description	R _m (N/mm ²)	kcX (N/mm ²)	m _c
N	10	AW7075 AlSi12 CuZn37	Aluminium alloys: Low Si Aluminium alloys: High Si Copper alloys			

Heat Resistant Super Alloys

ISO	PSM	Material Example	Description	R _m (N/mm ²)	kcX (N/mm ²)	m _c
S	11	Inconel 718	Ni-based super-alloys Titanium alloys		3300 1450	0.24 0.23

Please note that the R_m value is only for selection of the material group and when the material has been heat treatment or other methods that increase the strength of the material.

WORKPIECE MATERIALS - PALBIT SELECTION MATERIALS, PSM

ISO	DIN	W.-Nr	EN	EN-Nr	AFNOR	BS	UNI	
1	20Mn5	1.1133			20M5	120M19	G22Mn3	
	30Mn5	1.1165	G28Mn6	1.1165		120M36		
	C10	1.0301	C10	1.0301	AF34C 10;XC10	045M10	C10	
	C15	1.0401			AF37C 12;XC18	080M15	C15;C16	
	C22	1.0402	C22+N	1.0402	C20	050A20	C20;C21	
	C25	1.0406	C25+N	1.0406	AF50C30	070M26	C25	
	Ck10	1.1121	C10E	1.1121	XC10	040A10	C10	
	Ck15	1.1141	C15R	1.1141	XC15;XC18	080M15	15;C16	
	Ck22	1.1151	C22E	1.1151	XC25;XC18	040A22	C20	
	Ck25	1.1158			XC25	060A25	C25	
	St37-2	1.0037	S235JR	1.0037	E24-2		Fe360B	
	St37-3	1.0116	S235JRG2	1.0038	E24-3;E24-4	4360-40C	Fe360DFF	
	St44-2	1.0044	S275J0H	1.0149	E28-2	4360-43B	Fe430BFN	
	St44-3N	1.0144	S275J2G3	1.0144	E28-3;E28-4	4360-43C	Fe430DFF	
	10S20	1.0721	10S20	1.0721	10F1	210M15	CF10S20	
	10SPb20	1.0722			10PbF2		CF10SPb20	
	15S20	1.0723	15SMn13	1.0725		210A15		
	35S20	1.0726	35S20	1.0726	35MF4	212M36		
	46S20	1.0727	46S20	1.0727	45MF4	212M44		
	60S20	1.0728	60S20	1.0728	60MF4			
	9S20	1.0711				220M07	CF9S22	
	9SMn28	1.0715	11SMn30	1.0715	S250	230M07	CF9SMn28	
	9SMn36	1.0736	11SMn37	1.0736	S300	240M07	CF9SMn36	
	9SMnPb28	1.0718	11SMnPb30	1.0718	S250Pb		CF9SMnPb28	
	9SMnPb36	1.0737	11SMnPb37	1.0737	S300Pb		CF9SMnPb36	
	14Ni6	1.5622			16N6		14Ni6	
	16Mo5	1.5423				1503-245-420	16Mo5	
	36Mn5	1.1167	G28Mn6+QT	1.1165	40M5	150M36		
	40Mn4	1.1157			35M5	150M36		
	C30	1.0528			C30	080A30		
	C35	1.0501	C35+N		AF55C35	060A35	C35	
	C40	1.0511	C40+N		AF60C40	080M40	C40	
	C45	1.0503	E335	1.0503	AF65C45	80M46	C45	
	C50	1.0540	C50+N		C50	080M50		
	Ck30	1.1178	C30E	1.1178		060A30		
	Ck35	1.1181	C35E	1.1181	XC38H1;XC32	080M36	C35	
	Ck40	1.1186	C40E	1.1186	XC42H1	080M40	C40	
	Ck50	1.1206	C50E	1.1206	XC48H1	080M50		
	Ck55	1.1203	C55E	1.1203	XC55	070M55	C50	
	St52-3	1.0570	S355JR	1.0570	E36-3;E36-4	4360-50C	Fe510B;C;D	
	St70-2	1.0535	E360	1.0070	A70-2		Fe690	
	2	12Ni19	1.5680			Z18N5		
		13Cr2	1.7012					
		13CrMo44	1.7335	13CrMo45	1.7335	15CD3.5	1501-620Gr.27	14CrMo45
		14MoV63	1.7715				1503-660-440	
14NiCr10		1.5732			14NC11		16NiCr11	
14NiCr14		1.5752	14NiCr14	1.5752	12NC15	655M13		
15Cr3		1.7015			12C3	523M15		
15CrMo5		1.7262			12CD4		12CrMo4	
15CrMoV59		1.8521						
15CrNi6		1.5919			16NC6	S107	16CrNi4	
15Mo3		1.5415	16Mo3	1.5415	15D3	1501-240	16Mo3	
15NiCr14		1.2735			10NC12			
16CrMo44		1.7337			15CD4.5	1501-620Gr.27	14CrMo45	
16MnCr5		1.7131	16MnCr5	1.5715	16MC5	527M17	16MnCr5	
16MnCrS5		1.7139	16MnCrS5	1.7139				
18CrNi8		1.5920			20NC6			
18CrNiMo6		1.6587	17CrNiMo6	1.6587	18NCD6	820A16	18NiCrMo7	
20CrMo2		1.7311						
20CrMo5		1.7264	20CrMo5	1.7264	18CD4			
20MnCr5		1.7147	20MnCr5	1.7147	20MC5		20MnCr5	
20MnCrS5		1.7149	20MnCrS5	1.7149	20MnCrS5			
20MoCr4		1.7321						
20MoCrS4		1.7323						
21MnCr5		1.2162			20NC5			

JIS	SS	UNS	AISI/ASTM	Misc. Brand	Condition	Form	Structure
SMnC420		G10220	1022;1518				
SMn1H;SCMn2		G13300	1330				
S10C		G10100	1010				
	1350	G10170	1015				
	1450	G10200	1023				
S25C			1025				
S10C;S9CK	1265	G10100	1010				
S15C;S15CK	1370	G10170	1015				
S22C;S20CK			1022				
S25C		G10250	1025				
STKM12C	1311						
	1312;1313		A573Gr.58				
SM41B	1412		A570Gr.40				
SM41C	1412;1414		A573Gr.70				
			1108				
			11L08				
SUM32	1922						
	1957	G11400	1140				
	1973	G11460	1146				
SUM21		G12120	1212				
SUM22	1912	G12130	1213				
		G12150	1215				
SUM22L	1914	G12134	12L13				
	1926	G12144	12L14				
			A350-LF5				
SB450M		G45200	4520				
SMn438(H);SCMn3	2120	G13350	1335				
		G10390	1039				
S30C							
	1550	G10350	1035				
S40C			1040				
S45C	1650	G10430	1045				
S50C			1049				
S30C			1030				
S35C	1572	G10340	1035				
S40C			1040				
			1050				
S55C			1055				
SM50YA	2172;2132						
	1655		1055				
			2515				
	2216		A182-F11;F12				
SNC415(H)			3415				
SNC815(H)		G33106	3310;9314				
SCr415(H)		G50150	5015				
SCM415(H)							
			4320				
	2912		A204Gr.A				
SNC22		T51606	P6				
	2216		A387Gr.12Cl.2				
SCR415	2511	G51170	5115				
SCM421							
SMnC420(H)		G51200	5120				
SMnC21H			5120H				
SCR420H							

WORKPIECE MATERIALS - PALBIT SELECTION MATERIALS, PSM

ISO	DIN	W.-Nr	EN	EN-Nr	AFNOR	BS	UNI
2	21NiCrMo2	1.6523	20NiCrMoS22	1.6526	20NCD2	805M20	20NiCrMo2
	23CrMoB33	1.7271					
	25CrMo4	1.7218	25CrMo4	1.7218	25CD4S	1717CDS110	25CrMo4(KB)
	25MoCr4	1.7325					
	25MoCrS4	1.7326					
	28Cr4	1.7030	28Cr4	1.7030		530A30	
	28NiCrMo4	1.6513					
	30CrMoV9	1.7707					
	30CrNiMo8	1.6580			30CND8	823M30	30NiCrMo8
	31CrMoV9	1.8519	31CrMoV9	1.8519	32CDV12		
	31NiCr14	1.5755			30NC11	653M31	
	32Cr2	1.7020					
	32CrMo12	1.7361			30CD12	722M24	32CrMo12
	34Cr4	1.7033	34Cr4	1.7033	32C4	530A32	34Cr4(KB)
	34CrMo4	1.7220	34CrMo4	1.7220	35CD4	708A37	35CrMo4
	35CrMo4	1.2330			34CD4	708A37	35CrMo4
	35NiCr18	1.5864					
	36CrNiMo4	1.6511	36CrNiMo4+TA		40NCD3	816M40	38NiCrMo4(KB)
	36NiCr10	1.5736			35NC11		35NiCr9
	36NiCr6	1.5710			35NC6	640A35	
	37Cr4	1.7034			38C4	530A36	38Cr4
	37MnSi4	1.5122					
	38Cr2	1.7003	38Cr2	1.7003	38C2		38Cr2
	38MnSi4	1.5120					
	39CrMoV139	1.8523				897M39	36CrMoV139
	40CrMnMo7	1.2311					
	40CrMnMoS86	1.2312			40CMD8S		
	40CrMnNiMo8	1.2738			40CND8		
	41Cr4	1.7035	41Cr4	1.7035	42C4	530M40	41Cr4
	41CrMo4	1.7223			42CD4TS	708M40	41CrMo4
	42Cr4	1.7045			42C4TS	530A40	41Cr4
	42CrMo4	1.7225	42CrMo4	1.7225	42CD4	708M40	42CrMo4
	42CrV6	1.7561					
	42MnV7	1.5223					
	43CrMo4	1.3563					
	44Cr2	1.3561					
	46Cr2	1.7006			42C2		45Cr2
	46MnSi4	1.5121					
	48CrMo4	1.3565					
	50CrMo4	1.7228				708A47	
	50CrV4	1.8159	50CrV4	1.8159	50CV4	735A50	51CrV4
	50MnSi4	1.5131	50MnSi4	1.5131			
	53MnSi4	1.5141					
	55Cr3	1.7176	55Cr3	1.7176	55C3	527A60	55Cr3
	55Si7	1.0904	55SiCr7	1.7100	55S7	250A53	55Si8
	58SiCr8	1.2103					
	60SiCr7	1.0961			60SC7		60SiCr8
	62SiMnCr4	1.2101					
	C45W	1.1730			Y342		
	C55W	1.1820					
	C60	1.0601	C60+N	1.0601	CC55	080A62	C60
	C60W	1.1740			Y355		
C67W	1.1744						
C70W1	1.1520						
C70W2	1.1620						
C75W	1.1750	C75W	1.1750		BW1A		
C80W1	1.1525			Y190;Y180		C80KU	
C80W2	1.1625			Y180	BW1B	C80KU	
C85W	1.1830			Y390			
Ck45	1.1191	C45E	1.1191	XC42	080M46	C45	
Ck60	1.1221	C60E	1.1221	XC60	080A62	C60	
Ck67	1.1231	C67S	1.1231	XC68	060A67	C70	
Ck75	1.1248	C75S	1.1248	XC75	060A78	C75	
GS-50CrV4	1.8159						
St60-2	1.0060	E335	1.0060	A60-2	4360-SSE;SSC	Fe590;Fe60-2	

JIS	SS	UNS	AISI/ASTM	Misc. Brand	Condition	Form	Structure
SUS410	2506	G86170	8620				
SUS405							
SUH442	2225	G41300	4130				
SUS410							
SUS430F							
SUS416			5130				
SUS410J1							
SCS5							
SUH409							
SUS403	2240						
SUS430		G51320	5132				
SUS405	2234	G41350	4135;4137				
	2234	T51620	4135				
SUS430LX							
SUS430LX		G98400	9840				
			3435				
SUJ2			3135				
SKS3			5135				
SKS43							
SKS31							
			P20				
			P20+S				
			P20+Ni				
		G51400	5140				
	2244	G41420	4142;4140				
	2245*)		5140				
	2244	G41400	4142;4140				
SNCM447							
SNCM240							
SNCM439							
SACM645			5045				
			5045				
		G41470	4150				
	2230	H61500	6150				
	2253	G51550	5155				
	2085;2090		9255				
			9262				
SK3							
SK2							
SK1		G10600	1060				
SUP4							
		T72301	W1				
			W108				
SUS420J1							
SUS431	1672	G10420					
	1665;1678	G10640	1064				
SUS420J2	1770	G10700	1070				
	1774;1778	G10780	1078;1080				
			6150H				
SUS420							

WORKPIECE MATERIALS - PALBIT SELECTION MATERIALS, PSM

ISO	DIN	W.-Nr	EN	EN-Nr	AFNOR	BS	UNI
2	X10Cr13	1.4006	X12Cr13	1.4006	Z12C13	410S21	X12Cr13
	X10CrAl13	1.4724	X10CrAl13	1.4724	Z10C13	BH12	X10CrAl12
	X10CrAl24	1.4762	X10CrAl24	1.4762	Z10CAS24		X16Cr26
	X12Cr13	1.4006	X12Cr13	1.4006		410S21	
	X12CrMoS17	1.4104	X14CrMoS17	1.4104	Z10CF17	441S29	X10CrS17
	X12CrS 13	1.4005	X12CrS 13	1.4005	Z12CF13	416S21	X12CrS13
	X15Cr13	1.4024	X12Cr13	1.4024	Z12C13	420S29	
	X2CrMoTi182	1.4521	X2CrMoTi182	1.4521			
	X2CrMoTi182	1.4521	X2CrMoTi182	1.4521			
	X2CrNi12	1.4003	X2CrNi13	1.4003			
	X5CrNi134	1.4313	X3CrNiMo133	1.4313	Z5CN13.4	425C11	X6CrNi1304
	X5CrTi12	1.4512	X5CrTi12	1.4512	Z6CT12	409S19	X6CrTi12
	X6Cr13	1.4000	X6Cr13	1.4000	Z6C12	403S17	X6 Cr13
	X6Cr17	1.4016	X6Cr17	1.4016	Z8C17	430S15	X8 Cr17
	X6CrAl13	1.4002	X6CrAl13	1.4002	Z6CA13	405S17	X6CrAl13
	X6CrMo4	1.2341	X6CrMo4	1.2341			
	X6CrTi17	1.4510	X6CrTi17	1.4510	Z8CT17		X6CrTi17
	X8CrNb 17	1.4511	X3CrNb 17	1.4511	Z8CNb17		X6CrNb17
	10CrMo910	1.7380	10CrMo910	1.7380	10CD9.10	1501-622Gr.31;45	12CrMo910
	100Cr6	1.3505	100Cr6	1.3505	100C6	534A99	100Cr6
	100MnCrW4	1.2510			90MWCv5	BO1	95MnWCr5KU
	100V1	1.2833			Y1105V	BW2	102V2KU
	105WCr6	1.2419	105WCr6	1.2419	105WC13		107WCr5KU
	115CrV3	1.2210	107CrV3	1.2210	100C3		107CrV3KU
	120WV4	1.2516			110WC20	BF1	110W4KU
	14CrMoV69	1.7735	14CrMoV69	1.7735	20CDV5.07		
	14NiCr18	1.5860					
	21CrMoV57	1.7709					
	32NiCrMo145	1.6746			35NCD14	830M31	
	34CrAl6	1.8504	34CrAl6	1.8504			
	34CrAlMo5	1.8507			30CAD6.12	905M31	34CrAlMo7
	34CrAlNi7	1.8550	34CrAlNi7	1.8550	34CAND7		
	34CrAlS5	1.8506					
	34CrNiMo6	1.6582	34CrNiMo6	1.6582	35NCD6	817M40	35NiCrMo6(KW)
40NiCrMo22	1.6546			40NCD2	311-Type7	40NiCrMo2(KB)	
40NiCrMo6	1.6565				311-Type6		
3	41CrAlMo7	1.8509	41CrAlMo710	1.8509	40CAD6.12	905M39	41CrAlMo7
	45WCrV7	1.2542				BS1	45WCrV8KU
	50NiCr13	1.2721					
	58CrV4	1.8161					
	60MnSiCr4	1.2826					
	60WCrV7	1.2550			55WC20		55WCrV8KU
	67SiCr5	1.7103					
	90CrSi5	1.2108					
	90Mn4	1.1273					
	90MnCrV8	1.2842	90MnCrV8	1.2842	90MV8	BO2	90MnVCr8KU
	C105W1	1.1545	C105U	1.1545	Y1105		C100KU
	C105W2	1.1645			Y1105		C100KU
	C110W	1.1654					
	C125W	1.1663			Y2120		C120KU
	C135W	1.1673			Y2140		C140KU
	Ck101	1.1274	C100S	1.1274		060A96	
	GS-34CoCrMoV1912	1.2887					
	G-X28CrMoV51	1.2392					
	G-X37CrMoV51	1.2606					
	X18CrN28	1.4749	X18CrN28	1.4749	Z18C25		
	X19NiCrMo4	1.2764					
	X20Cr13	1.4021	X20Cr13	1.4021	Z20C13	420S37	X20Cr13
	X20CrMoWV121	1.4935	X20CrMoWV121	1.4935			
	X20CrNi172	1.4057	X20CrNi172	1.4057	Z15CN16.02	431S29	X16CrNi16
	X22CrMoV121	1.4923	X22CrMoV121	1.4923	Z21CDV12	762	X22CrMoV121
	X30Cr13	1.4028	X30Cr13	1.4028	Z30C13	420S45	X30Cr13
	X36CrMo17	1.2316	X38CrMo16	1.2316	Z35CD17		X38CrMo 161KU
	X4CrNiMo165	1.4418	X4CrNiMo165	1.4418	Z6CND16.05.01		
	X40Cr13	1.4031	X39Cr13	1.4031	Z40C14	(420S45)	X40Cr14

WORKPIECE MATERIALS - PALBIT SELECTION MATERIALS, PSM

ISO	DIN	W.-Nr	EN	EN-Nr	AFNOR	BS	UNI
3	X45Cr13	1.4034	X45Cr13	1.4034	Z40C14	(420S45)	
	X45CrNiW189	1.4873	X45CrNiW189	1.4873	Z35CNWS18.09	331S40	X45CrNiW189
	X45NiCrMo4	1.2767	X45NiCrMo4	1.2767	45NCD17	EN20B	42NiCrMo157
	X65CrMo14	1.4109	X70CrMo15	1.4109	Z70D14		
	X80CrNiSi20	1.4747	X80CrNiSi20	1.4747	Z80CSN20.02	443S65	X80CrSiNi20
	X90CrMoV18	1.4112	X90CrMoV18	1.4112	Z2CND1805	409S19	XCrTi12
	54NiCrMoV6	1.2711	54NiCrMoV6	1.2711	55NCDV6	BH224	
	55NiCrMoV6	1.2713			55NCDV7		
	57NiCrMoV77	1.2744					
	75CrMoNiW67	1.2762					
	81CrMoV4216	1.2369					
	G-X165CrCoMo12	1.2880					
	G-X165CrMoV12	1.2601					
	G-X165CrV12	1.2201					
	S10-4-3-10	1.3207	HS10-4-3-10	1.3207	Z130WKCDV10-4-3-10	BT42	HS10-4-3-10
	S12-1-2	1.3318	HS12-1-2	1.3318			
	S12-1-4	1.3302	HS12-1-4	1.3302			
	S12-1-4-5	1.3202	HS12-1-4-5	1.3202			
	S18-0-1	1.3355	HS18-0-1	1.3355	Z80WCV18-04-01	BT1	HS18-0-1
	S18-1-2-10	1.3265	HS18-1-2-10	1.3265		BT5	HS18-0-1-10
	S18-1-2-15	1.3257	HS18-1-2-15	1.3257			
	S18-1-2-5	1.3255	HS18-1-2-5	1.3255	Z80WKCV18-05-04-0	BT4	HS18-1-1-5
	S2-10-1-8	1.3247	HS2-10-1-8	1.3247	Z110DKCWW09-08-04	BM42	HS2-9-1-8
	S2-9-1	1.3346	HS2-9-1	1.3346	Z85DCWV08-04-02-0	BM1	HS1-8-1
	S2-9-2	1.3348	HS2-9-2	1.3348	Z100DCWV09-04-02-		HS2-9-2
	S2-9-2-8	1.3249				BM34	
	S3-3-2	1.3333	HS3-3-2	1.3333			HS3-3-2
	S6-5-2	1.3343	HS6-5-2	1.3343	Z85WDCV06-05-04-0	BM2	HS6-5-2
	S6-5-2-5	1.3243	HS6-5-2-5	1.3243	Z85WDCV06-05-05-04-02		HS6-5-2-5
	S6-5-3	1.3344	HS6-5-3	1.3344	Z120WDCV06-05-04-	BM4	HS6-5-3
	S6-5-3C	1.3345	S-6-5-3C	1.3345			
	S7-4-2-5	1.3246	HS7-4-2-5	1.3246	Z110WKCDV07-05-04		HS7-4-2-5
	X100CrMoV51	1.2363	X100CrMoV5	1.2363	Z100CDV5	BA2	X100CrMoV51KU
	X105CrMo17	1.4125	X105CrMo17	1.4125	Z100CD17		X105CrMo17
	X155CrVMo121	1.2379	X155CrVMo121		Z160CDV12	BD2	X155CrVMo121KU
	X165CrMoV12	1.2601					X165CrMoV12KU
	X2NiCoMoTi1895	1.2709			Z2NKD19-09		
	X210Cr12	1.2080	X210Cr12	1.2080	Z200C12	BD3	X210Cr13KU
	X210CrW12	1.2436					X215CrW121KU
	X3NiCrMo1885	1.2706			E-Z2NKD18		
	X30WCrV53	1.2567			Z32WCV5		X30WCrV53KU
	X30WCrV93	1.2581			Z30WCV9	BH21	X30WCrV93KU
X32CrMoCoV333	1.2885						
X32CrMoV33	1.2365			32DCV28	BH10	30CrMoV1227KU	
X38CrMoV51	1.2343			Z38CDV5	BH11	X37CrMoV51KU	
X38CrMoV53	1.2367						
X40CrMoV51	1.2344	X40CrMoV51	1.2344	Z40CDV5	BH13	X40CrMo511KU	
4	X10CrNiS189	1.4305	X8CrNiS189	1.4305	Z10CNF18.09	303S31	X10CrNi1809
	X12CrNi177	1.4310	X9CrNi188	1.4310	Z12CN17.07	301S21	X12CrNi1707
	X12CrNi188	1.4300	X12CrNi188	1.4300	Z12CN18	302S25	
	X5CrNiNb1810	1.4546	X5CrNiNb1810	1.4546		347S31	X6CrNiNb1811
	X6CrNi1810	1.4301	X5CrNi189	1.4301	Z6CN18.09	304S31	X5CrNi1811
	X6CrNi1811	1.4948	X6CrNi18 11	1.4948	Z6CN18.09	304S51	X5CrNi1810KW
	X6CrNi1812	1.4303	X4CrNi18 11	1.4303	Z8CN18.11FF	305S19	X7CrNi1810
	X6CrNiNb1810	1.4550	X6CrNiNb1810	1.4550	Z6CnNb18.10	347S31	X6CrNiNb1811
5	X10CrNiMoNb1812	1.4583	X5CrNiMoNb19112	1.4583	Z6CNDNb17.13	318C17	X6CrNiMoNb1713
	X12CrNi2521	1.4335	X12CrNi2521	1.4335	Z12CN25.20	310S24	X6CrNi2620
	X12CrNiTi189	1.4541	X6CrNiTi1810	1.4878	Z6CNT18.12	321S51	X6CrNiTi1811
	X12CrNiW163	1.4962	X12CrNiW163	1.4962	Z6CnNb18.10		
	X15CrNiSi2012	1.4828	X15CrNiSi2012	1.4828	Z17CNS20.12	309S24	
	X2CrNi1911	1.4306	X2CrNi19 11	1.4306	Z2CN18.10	304S12	X3CrNi1811
	X2CrNiMo17132	1.4404	X2CrNiMo17122	1.4404	Z2CND17.12.02	316S11	X2CrNiMo17122
	X2CrNiMo18143	1.4435	X3CrNiMo18143	1.4435	Z2CND17.13	316S12	X2CrNiMo17132
	X2CrNiMo18164	1.4438	X2CrNiMo18154	1.4438	Z2CND19.15.4	317S12	X2CrNiMo1816

JIS	SS	UNS	AISI/ASTM	Misc. Brand	Condition	Form	Structure
	[2304]						Martensite
SUH31			SAEHNV3 6F7				Martensite
SUS440A		S44002	440A				Martensite
SUH4		S65006	SAEHNV6	sol.treated			PH
SUS440B	2327	S44003	440B 6F2				Martensite
SKT4		T61206	L6				
SKH57							
		T12015	T15				
SKH2		T12001	T1				
SKH4A		T12005	T5				
SKH3		T12004	T4				
SKH51		T11342	M42				
		T11301	H41;M1				
	2782	T11307	M7				
		T11333	M33;M34				
SKH9;SKH51	2722	T11302	M2				
SKH53	2723		M35				
SKH52;SKH53		T11323	M3Cl.2				
SKH55		T11323	M3				
		T11341	M41				
SKD12	2260	T30102	A2				
SUS440C		S44004	440C				Martensite
SKD11		T30402	D2				
	2310						
			18MAR300				
SKD1		T30403	D3				
SKD2	2312						
		K93120					
SKD4							
SKD5		T20821	H21				
SKD7		T20810	H10				
SKD6		T20811	H11				
SKD61	2242	T20813	H13				
SUS303	2346	S30300	303				Austenite
SUS301	(2331)	S30100	301				Austenite
SUS302	2331	S30200	302				Austenite
		S34800	348				Austenite
SUS304	2333	S30400	304;304H				Austenite
SUS304H	2333	S30480	304H				Austenite
SUS305	2333	S30500	308;305				Austenite
SUS347	2338	S34700	347				Austenite
SCS22			318				Austenite
SUH310;SUS310S	2361	S31008	310S				Austenite
SUS321	2337	S32100	321;321H				Austenite
		S34700	347H				Austenite
SUH309		S30900	309				Austenite
SUS304L	2352	S30403	304L				Austenite
SUS316L	2348	S31603	316L				Austenite
SCS16;SUS316L	2353	S31603	316L				Austenite
SUS317L	2367	S31703	317L				Austenite

WORKPIECE MATERIALS - PALBIT SELECTION MATERIALS, PSM

ISO	DIN	W.-Nr	EN	EN-Nr	AFNOR	BS	UNI
5	X2CrNiN1911	1.4311	X2CrNiN1810	1.4311	Z2CN18.10Az	304S62	X2CrNiN1811
	X5CrNiMo17133	1.4436	X5CrNiMo17133	1.4436	Z6CND18.12.03	316S33	X5CrNiMo17132
	X6CrNi189	1.4308	X5CrNi19 10	1.4308	Z6CN18.10M	304C15	
	X6CrNiMoNb17122	1.4580	X6CrNiMoNb17122	1.4580	Z6CNDNb17.12	318S17	X6CrNiMoNb1712
	X6CrNiMoTi17122	1.4571	X6CrNiMoTi17122	1.4571	Z6CNDT17.12	320S31	X6CrNiMoTi1712
	X15CrNiSi2520	1.4841	X15CrNiSi2520	1.4841	Z15CNS25.20	314S25	X16CrNiSi2520
X5CrNiMo1810	1.4401	X5CrNiMo17122	1.4401	Z3CND17.11.1	316S31	X5CrNiMo1712	
6	X1CrNiMoN20187	1.4547	X1CrNiMoN20187	1.4547		X1CrNiMoN20187	X1CrNiMoN20187
	X1NiCrMoCuN31274	1.4563	X1NiCrMoCuN31274	1.4563			
	X10NiCrAlTi3220	1.4876	X10NiCrAlTi3220	1.4876	Incoloy800	Z10NC32.21	
	X12NiCrSi3616	1.4864	X12NiCrSi3516	1.4864	Z20NCS33.16	NA17	
	X2CrNiMoN2574	1.4410	X2CrNiMoN 2574	1.4410	Z3CND25.07Az		X2CrNiMoN2574
	X2CrMoNiCuN2563	1.4507	X2CrMoNiCuN2563	1.4507			
	X2CrNiMoCuWN2574	1.4501	X2CrNiMoCuWN2574	1.4501	Z3CND25.06Az		
	X2CrNiMoN17122	1.4406	X2CrNiMoN17112	1.4406	Z2CND17.12Az	316S61	X2CrNiMoN1712
	X2CrNiMoN17133	1.4429	X2CrNiMoN17133	1.4429	Z2CND17.13Az	316S62	X2CrNiMoN17133
	X2CrNiMoN17133	1.4439	X2CrNiMoN17135	1.4439	Z3CND18.14.05Az	(316S63)	
	X2CrNiMoN225	1.4462	X2CrNiMoN 2253	1.4462	Z2CND22.05Az	332S15	X2CrNiMoN225
	X2CrNiMoN225	1.4462	X2CrNiMoN225	1.4462	Z2CND22.05Az	318S13	X2CrNiMoN225
	X2CrNiMoN25227	1.4652	X1CrNiMoN25228	1.4652			
	X2CrNiN234	1.4362	X2CrNiN234	1.4362			
	X2NiCrMoCu25205	1.4539	X2NiCrMoCu25205	1.4539	Z2NCDU2520	904S13	
	X2NiCrMoCu25205	1.4539	X1NiCrMoCu25205	1.4539			
X4CrNiCuNb164	1.4540	X4CrNiCuNb164	1.4540	Z4CNUNb16.4M			
X4CrNiMo2752	1.4460	X3CrNiMo2752	1.4460	Z3CND25.7Az		X3CrNiMo2752	
X5CrNiCuNb174	1.4542	X5CrNiCuNb164	1.4548	Z6CNU17.4			
7	GG-10	0.6100	EN-GJL-100	0.6100	Ft10D	Grade100	G10
	GG-15	0.6150	EN-GJL-150	0.6150	Ft15D	Grade150	G15
	GGG-35.3	0.7033	EN-GJS-350-22	0.7033	FGS370-17	Grade350/22	
	GGG-40	0.7040	EN-GJS-400-15	0.7040	FGS400-12	Grade420/12	GS400-12
	GGG-40.3	0.7043	EN-GJS-400-18	0.7043	FGS-370-17	Grade370/17	GSO42/17
	GTS-35-10		EN-GJMB-350-10	0.8135	B340/12	B340/12	B35-12
	GTS-45-06		EN-GJMB-450-6	0.8145	P440/7	P440/7	P45-06
GTS-55-04		EN-GJMB-550-4	0.8155	P540/5	P540/5	P55-04	
8	GG-20	0.6200	EN-GJL-200	0.6200	Ft20D	Grade220	G20
	GG-25	0.6250	EN-GJL-250	0.6250	Ft25D	Grade260	G25
	GGG-50	0.7050	EN-GJS-500-7	0.7050	FGS500-7	Grade500/7	GS500-7
	GGG-60	0.7060	EN-GJS-600-3	0.7060	FGS600-3	Grade600/3	GS600-3
	GGG-NiCr202	0.7660	EN-GJSA-XNiCr20-2	0.7660	FGSNI20Cr2	GradeS2	
	GGG-NiCr203	0.7661	EN-GJSA-XNiCr20-3	0.7661	FGSNI20Cr3	GradeS2B	
	GGG-NiMn137	0.7652	EN-GJSA-XNiMn13-7	0.7652	FGSNI13Mn7	GradeS6	
	GGL-NiCr202	0.6660	EN-GJLA-XNiCr20-2	0.6660	FGLNi20Cr2	GradeF2	
	GGL-NiCr203	0.6661	EN-GJLA-XNiCr20-3	0.6661	FGLNi20Cr3		
GTS-65-02		EN-GJMB-600-3	0.8165	P570/3	P570/3	P65-02	
9	GG-30	0.6300	EN-GJL-300	0.6300	Ft30D	Grade300	G30
	GGG-70	0.7070	EN-GJS-700-2	0.7070	FGS700-2	Grade700/2	GS700-2
	GGL-NiCuCr1562	0.6655	EN-GJLA-XNiCuCr15-6-2	0.6655	FGLNi15Cu6Cr2	GradeF1	
	GGL-NiCuCr1563	0.6656	EN-GJLA-XNiCuCr15-6-3	0.6656	FGLNi15Cu6Cr3		
	GTS-70-02		EN-GJMB-700-2	0.8170	P690/2	P690/2	P70-02
	GG-35	0.6350	EN-GJL-350	0.6350	Ft35D	Grade350	G35
	GG-40	0.6040	-	0.6040	Fgl400	Grade400	
	GGG-80	0.7080	EN-GJS-800-2	0.7080	FGS800-2		GS800-2
	GGG-Ni22	0.7670	EN-GJSA-XNi22	0.7670	FGSNI22		
	GGG-Ni35	0.7683	EN-GJSA-XNi35	0.7683	FGSNI35		
	GGG-NiCr301	0.7677	-	0.7677	FGSNI30Cr1		
	GGG-NiCr303	0.7676	EN-GJSA-XNiCr30-3	0.7676	FGSNI30Cr3	GradeS3	
	GGG-NiCr353	0.7683	EN-GJSA-XNiCr35-3	0.7683	FGSNI35Cr3		
	GGG-NiMn234	0.7673	EN-GJSA-XNiMn23-4	0.7673	FGSNI23Mn4	GradeS2M	
	GGG-NiSiCr2052	0.7665	EN-GJSA-XNiSiCr20-5-2	0.7665	FGSNI20Si5Cr2		
	GGG-NiSiCr3055	0.7680	EN-GJSA-XNiSiCr30-5-5	0.7680	FGSNI30Si5Cr5		
GGL-NiCr303	0.6676	EN-GJLA-XNiCr30-3	0.6676	FGLNi30Cr3	GradeF3		
GGL-NiSiCr2053	0.6667	EN-GJLA-XNiSiCr20-5-3	0.6667	FGLNi20Si5Cr3			
GGL-NiSiCr3055	0.6680	-	0.6680	FGLNi30Si5Cr5			

JIS	SS	UNS	AISI/ASTM	Misc. Brand	Condition	Form	Structure
SUS304LN	2371	S30453	304LN				Austenite
SUS316	2343	S31600	316				Austenite
SCS13	2333		CF8				Austenite
		S31640	316Cb				Austenite
SUS316Ti	2350		316Ti				Austenite
SUH310		S31000	314;310				Austenite
SUS316	2347	S31600	316				Austenite
	2778	S31254		254SMO			Superaustenite
		N08028		Sanicro28			Superaustenite
NCF800		N08800		Alloy800	sol.treated		PH
SUH330		N08330	330	IncoloyDS			Austenite
	2328	S32750	F53	SAF2507			Superduplex
		S32550	F55	Ferralium			Superduplex
		S32760	F55	Zeron100			Superduplex
SUS316LN		S31653	316LN				Austenite
SUS316LN	2375	S31653	316LN				Austenite
(SUS316LN)		(S31653)	(316LN)				Austenite
	2377	S31803	329LN	SAF2205			Duplex
SUS329J3L	2377	S32205	318	SAF2205			Duplex
		S32654		654SMO			Superaustenite
	2327	S32304	-	SAF2304			Duplex
	2562	N08904	904L				Superaustenite
	2564		CN7M				Superaustenite
		S15500	XM-12	15-5-PH	sol.treated		PH
SUS329J1	2324	S32900	329				Duplex
SCS24;SUS630		S17400	630	17-4-PH	sol.treated		Superaustenite
FC100	0110-00	F11401	A1820B				GCI
FC150	0115-00	F11601	A4825B				GCI
FCD350-22L	0717-15						DCI
FCD400-18L	0717-02	F32800	60-40-18				DCI
	0717-12	F32800	60-40-18				DCI
FCMB35-10	0815-00	F22200	A4732510				Martensite
PCMP45-06	0852-00	F23130	A22045008				Martensite
PCMP55-04	0854-00	F24130	A22060004				Martensite
FC200	0120-00	F12101	A4830B				GCI
FC250	0125-00	F12401	A4835B				GCI
FCD500-7	0727-02	F33800	A53680-55-6				DCI
FCD600-3	0732-03	F34100	A47680-60-03				DCI
		F43000	A436TypeD-2				Austenite
		F43001	A436TypeD-2B				Austenite
	0772-00	-	-				Austenite
	0523-00	F41002	A436 Type2				Austenite
		F41003	A436Type2b				Austenite
PCMP60-03	0856-00	F24830	A22070003				Martensite
FC300	0130-00	F13101	A4845B				GCI
FCD700-2	0737-01	F34800	A536100-70-03				DCI
		F41000	A436 Type1				Austenite
		F41001	A436 Type1b				Austenite
PCMP70-02	0862-00	F26230	A22090001				Martensite
FC350	0135-00	F13502	A4850B				GCI
	0140-00	F14102	A27860B				GCI
FCD800-2		F36200	A536120-90-02				Martensite
			A439TypeD-2B				Austenite
		F43006	A439TypeD-5				Austenite
		F43004	A436TypeD-3A				Austenite
		F43003	A436TypeD-3				Austenite
		F43007	A436TypeD-5B				Austenite
		F43010	A439TypeD-2M				Austenite
		-	NicrosilalSpheronic				Austenite
		F43005	A439TypeD-4				Austenite
		F41004	A436 Type3				Austenite
			Nicrosilal				Austenite
			A436TypeD-4				Austenite

WORKPIECE MATERIALS - PALBIT SELECTION MATERIALS, PSM

ISO	DIN	W.-Nr	EN	EN-Nr	AFNOR	BS	UNI
10	Al99	3.0205	AW-1200	Al99	A-4/1200	1C/1200	
	Al99.5	3.0255	AW-105 0A	Al99.5	A-5/1050A	1B/1050A	
	Al99.7	3.0275	AW-1070	Al99.7	A-7/1070		
	Al99.8	3.0285	AW-1080	Al99.8	A-8/1080	1A	
	AlCu2.5Mg0.5	3.1305			A-U2G	2L69	
	AlCuBiPb	3.1655	AW-2011	AlCuBiPb	A-U5PbBi/2011	FC1/2011	
	AlCuMg1	3.1325	AW-2024	AlCuMg1	A-U4G/2024	H14	
	AlCuMg2	3.1355			A-U4G1	2L97/98	
	AlCuSiMn	3.1255	AW-2014	AlCuSiMn	A-U4SG/2014	H15/2014	
	AlMg1	3.3315	AW-5005A	AlMg1	A-G0.6	N41/5005	
	AlMg1.5	3.3316			A-G1.5		
	AlMg1SiCu	3.3211	AW-6061	AlMg1SiCu	(6061)	H20	
	AlMg2.5	3.3523	AW-5052	AlMg2.5	A-G2.5C/5052	(N4)	
	AlMg2.7Mn	3.3537	AW-5454	AlMg2.7Mn	A-G2.5MC/5454	N51/5454	
	AlMg2Mn0.3	3.3525	AW-5251	AlMg2Mn0.3	A-G2M	N4/5251	
	AlMg2Mn0.8	3.3527	AW-5049	AlMg2Mn0.8	A-G2Mn0.8		
	AlMg3	3.3535	AW-5754	AlMg3	A-G3M		
	AlMg4.5	3.3345					
	AlMg4.5Mn	3.3547	AW-5083	AlMg4.5Mn	A-G4.5MC	N8/5083	
	AlMg4Mn	3.3545	AW-5086	AlMg4Mn	A-G4MC/5086	(N5/6)	
	AlMgSi0.5	3.3206	AW-6060	AlMgSi0.5	A-GS/6060	(H9)/(6060)	
	AlMgSi0.7	3.3210	AW-6063	AlMgSi0.7	A-GSUC/6061	(H10)	
	AlMgSi1	3.2315	AW-6082	AlMgSi1	A-SGM0.7/6082	H30/6082	
	AlMgSiPb	3.0615			A-SGPb		
	AlMn0.5Mg0.5	3.0505	AW-3105	AlMn0.5Mg0.5		N31	
	AlMn0.5Mg0.5	3.0525	AW-3005	AlMn0.5Mg0.5	A-MG0.5/3005		
	AlMn1	3.0515	AW-3103	AlMn1		N3/3103	
	AlMn1Cu	3.0517	AW-3003	AlMn1Cu	A-M1/3003		
	AlMn1Mg1	3.0526	AW-3004	AlMn1Mg1	A-M1G/3004		
	AlZn4.5Mg1	3.4335	AW-7020	AlZn4.5Mg1	A-Z5G/7020	H17/7020	
	AlZnMgCu0.5	3.4345			A-Z4GU		
	AlZnMgCu1.5	3.4365	AW-7075		A-Z5GU/7075	2L95/96	
	G-AlCu4Ti	3.1841	AC-21100	AlCu4Ti			
	G-AlCu4TiMg	3.1371	AC-21000	AlCu4TiMg	A-U5GT	2L91/92	
	G-AlMg3	3.3541	AC-51100	AlMg3	A-G3T		
	G-AlMg3Si	3.3241					
	G-AlMg5	3.3261	AC-51400	AlMg5(Si)			
	G-AlMg5	3.3555	AC-51400	AlMg5		LM5	
	G-AlMg9	3.3292	AC-51200	AlMg9			
	G-AlSi10Mg	3.2381	AC-43400	AlSi10Mg(Fe)	A-S10G	LM9	
	G-AlSi5Mg	3.2341	AC-42000		A-S7G	LM25	
	G-AlSi6Cu4	3.2151	AC-45000	AlSi6Cu4			
	G-AlSi7Mg	3.2371	AC-42100	AlSi7Mg	A-S7GO3	2L99	
	G-AlSi8Cu3	3.2161	AC-46200	AlSi8Cu3(Si)			
	G-AlSi9Mg	3.2373	AC-43200	AlSi9Mg	A-S10G		
	G-MgAg3Se2Zr1	3.5106					
	G-MgAl3Zn	3.5314	MG-P-62	MgAl3Zn	G-A3-Z1	MAG-E-111	
	G-MgAl6Mn	3.5662	MC21230	MgAl6Mn			
	G-MgAl6Zn	3.5612	MG-P-63	MgAl6Zn	G-A6-Z1	MAG-E-121	
	G-MgAl8Zn	3.5812	MG-P-61	MgAl8Zn	G-A9	MAG1-M	
	G-MgAl8Zn1	3.5812	MC21110	MgAl8Zn1	G-A92	A82	
	G-MgAl9Zn1	3.5912	MC21120	MgAl9Zn1	G-A92	MAG3	
	G-MgMn2	3.5200			G-M2	MAG-E-101	
	G-MgSe3Zn2Zr1	3.5103	MB65110	MgSe3Zn2Zr1	ZRE1	MAG6-TE	
	G-MgTh3Zn2Zr1	3.5105					
	G-AlSi10Mg(Cu)	3.2383	AC-43200	AlSi10Mg(Cu)			
	GD-AlSi12	3.2382	AC-44200	AlSi12			
		AC-46100	AlSi11Cu2(Fe)		LM9		
		AC-47100	AlSi12Cu1(Fe)				
			AlSi17Cu5				
Cu		CW004A					
CuAg0.1	2.1203	CW013A	CuAg0.1		Cu-Ag-4		
CuAl10Fe	2.0940.01	CC331G			CuAl10Fe	AB1	
CuAl10Fe5Ni5		CC333G-GZ					
CuAl10Ni	2.0975.01	CC333G			CuAl10Ni5Fe5	AB2	
CuAl10Ni5Fe4	2.0966	CW307G	CuAl10Ni5Fe4	CuAl10Ni	CA104		

JIS	SS	UNS	AISI/ASTM	Misc. Brand	Condition	Form	Structure
A1200	4010	AA1200					
(A1050)	4007	AA1050A					
	4005	AA1070A					
	4004	AA1080A					
		AA2117					
A2011	4355	AA2011					
A2017		AA2017A					
		AA2024					
	4338	AA2014					
	4106	AA5005A					
		AA5050B					
A6061		AA6061					
A5052	4120	AA5052					
A5454		AA5454					
		AA5251					
	4115	AA5049					
	4125	AA5754					
A5082		AA5082					
	4140	AA5083					
		AA5086					
	4103	AA6060					
(A6063)	4104,4107	AA6005					
	4212	AA6082					
		AA6012					
		AA3105					
-		AA3005					
	4054	AA3103					
A3003		AA3003					
-		AA3004					
	4425	AA7020					
		AA7022					
A7075		AA7075					
	4337	A02040	204				
		A05140	5140				
			5056A				
	4163						
	4253	A13600	B85				
	4244		B26				
	4245	A13560					
	4251		A380				
			359,2				
			4418				
	4633	AZ31B					
		AM60A					
		AZ61A					
		AZ80A					
	4637	AZ81A					
	4635	AZ91A/B	4437				
		M1A					
		B80	4442				
		B80					
			A413.2				
ADC12			A384.0				
		AA384					
ADC14			B390.0				
	5015						
	5030	C11600					
	5710	C95200	CA952				
	5716	C95500	CA955				
C6301		C62730					

WORKPIECE MATERIALS - PALBIT SELECTION MATERIALS, PSM

ISO	DIN	W.-Nr	EN	EN-Nr	AFNOR	BS	UNI
10	CuAl5	2.0916					
	CuAl5As	2.0918	CW300G	CuAl5As			
	CuAl8Fe3	2.0932					
	CuCr	2.1291					
	CuFe2P	2.1310	CW107C	CuFe2P			
	CuNi1.5Si	2.0853	CW109C	CuNi1Si			
	CuNi10Fe1Mn	2.0872		CuNi10Fe1Mn	CuNi10Fe1Mn	CN102	
	CuNi10Zn45						
	CuNi12Zn30Pb1	2.0780	CW406J	CuNi12Zn30Pb1			
	CuNi18Zn19Pb	2.0790		CW408J	CuNi18Zn19Pb1		
	CuNi18Zn19Pb1	2.0790	CW408J	CuNi18Zn19Pb1	CuNi18Zn19Pb1		
	CuNi18Zn20	2.0740	CW409J	CuNi18Zn20	CuNi18Zn20	NS106	
	CuNi18Zn27	2.0742	CW410J	CuNi18Zn27		NS107	
	CuNi20	2.0822					
	CuNi25	2.0830			CuNi25	CN105	
	CuNi30	2.0835					CuNi30
	CuNi30Fe2Mn2	2.0883					
	CuNi30FeMn						
	CuNi30Mn1Fe	2.0882	CW354H	CuNi30Mn1Fe	CuNi30Mn1Fe	CN107	
	CuNi3Si	2.0857	CW112C	CuNi3Si			
	CuNi44Mn1	2.0842			CuNi44Mn		
	CuNi5Fe1Mn				CuNi5Fe1Mn		
	CuNi9Sn2	2.0875	CW351H	CuNi9Sn2			
	CuPb10Sn	2.1176	CW352H		CuSn10Pb10	LB2	
	CuPb15Sn	2.1183	CC496K-GZ				
	CuPb1P	2.1160	CW113C	CuPb1P			
	CuPb20Sn	2.1189					
	CuSn10	2.1050.01	CC480K		CuSn10	CT1	
	CuSn10Zn	2.1087					
	CuSn12	2.1051.01	CC483K		CuSn12	PB2	
	CuSn14				CuSn14		
	CuSn4	2.1016	CW450K	CuSn4	CuSn4P	PB101	
	CuSn5			CW451K			
	CuSn6	2.1020	CW452K	CuSn6	CuSn6	PB103	
	CuSn6Zn6	2.1080					
	CuSn7						CuSn7
	CuSn7ZnPb	2.1090.03	CC493K-GZ				
	CuSn8	2.1030	CW453K	CuSn8	CuSn8P	PB104	
	CuZn10	2.0230	CW501L	CuZn10	CuZn10	CZ101	
	CuZn15	2.0240	CW502L	CuZn15	CuZn15	CZ102	
	CuZn20	2.0250	CW503L	CuZn20		CZ103	
	CuZn20Al2	2.0460	CW702R	CuZn20Al2	CuZn22Al2	CZ110	
	CuZn25Al15						
	CuZn28	2.0261	CW504L	CuZn28		CZ105	
	CuZn28Sn1	2.0470	CW706R	CuZn28Sn1	CuZn29Sn1		
	CuZn30	2.0265	CW505L	CuZn30	CuZn30	CZ106	
	CuZn30AlFeMn				CuZn30AlFeMn		
	CuZn31Si1	2.0490	CW708R	CuZn31Si1			
	CuZn33	2.0280	CW506L	CuZn33		CZ107	
	CuZn35Al1	2.0592.01	CC765S		CuZn30AlFeMn	HTB1	
	CuZn35Ni2	2.0540	CW710R	CuZn35Ni2			
	CuZn36	2.0335	CW507L	CuZn36	CuZn36	CZ108	
	CuZn36Pb1.5	2.0331	CW601N	CuZn35Pb2	CuZn35Pb2	CZ131	
	CuZn36Pb3	2.0375	CW602N	CuZn36Pb3	CuZn36Pb3	CZ124	
CuZn37	2.0321	CW508L	CuZn37	CuZn37	CZ108		
CuZn37Pb0.5	2.0332	CW604N	CuZn37Pb0.5		CZ118		
CuZn38Pb1.5	2.0371	CW607N	CuZn38Pb1.5	(CuZn38Pb2)	CZ119		
CuZn38Sn1	2.0530	CW717R	CuZn38Sn1				
CuZn38SnAl	2.0525	CW715R	CuZn38SnAl				
CuZn39AlFeMn							
CuZn39Pb0.5	2.0372	CW610N	CuZn39Pb0.5	CuZn39Pb0.8	CZ123		
CuZn39Pb2	2.0380	CW612N	CuZn39Pb2		CZ128		
CuZn39Pb3	2.0401	CW614N	CuZn39Pb3	CuZn39Pb3	CZ121		
CuZn40	2.0360	CW509	CuZn40	CuZn40	CZ109		
CuZn40Al2	2.0550	CW713R					

JIS	SS	UNS	AISI/ASTM	Misc. Brand	Condition	Form	Structure
		C60800					
C6140		C18400					
		C19400					
	5667	C70600					
		C79300					
		C76300					
		C76300					
C7451		C75200					
		C77000					
		C71300					
		C71580					
	5682	C70600					
		C70250					
		C72150					
		C72500					
	5640	C93700	CA937				
		C93800					
		C19000					
		C94100					
	5443	C90700					
	5458	C90500					
	5465		CA907				
	5475	C91000					
C5111		C51100					
		C51000					
C5191	5428	C51900					
		C93200					
		C83600					
C5210		C52100					
C2200		C22000					
C2300	5112	C23000					
C2400		C24000					
	5217	C68700					
		C86300					
C4430		C25600					
	5220	C44300					
C2600	5122	C26000					
C2680		C26800					
	5256	C96500	CA865				
C2720		C27200					
		C34200					
		C36000					
	5150	C27200					
		C33500					
	5165	C35300					
		C46400					
		C47000					
		C36500					
		C37700					
	5170	C38500					
C2800		C28000					
		C67410					

WORKPIECE MATERIALS - PALBIT SELECTION MATERIALS, PSM

ISO	DIN	W.-Nr	EN	EN-Nr	AFNOR	BS	UNI
10	CuZn40Mn1	2.0572	CW723R	CuZn40Mn1			
	CuZn40Mn1Pb	2.0580	CW720R	CuZn40Mn1Pb			
	CuZn40Pb2	2.0402	CW612N	CuZn40Pb2	CuZn39Pb2		
	CuZn44Pb2	2.0410	CW622N	CuZn44Pb2			
	CuZn5	2.0220	CW500L	CuZn5		CZ136	
						CZ120	
						CZ104	
						CZ125	
11							
			1.4876	X2NiCrAlTi3220			
			2.4810	NiMo30			
			2.4810	NiMo30			
			2.4602				
			2.4819	NiMo16Cr15W			
			2.4610	NiMo16Cr16Ti			
			2.4619				
			NiCr21Fe18Mo9				
		2.4665					

JIS	SS	UNS	AISI/ASTM	Misc. Brand	Condition	Form	Structure
C2100	5168 5272	C37800					
		C68700					
		C21000					
					AMPCO15		
					AMPCO18		
					AMPCO18.136		
					AMPCO18.22		
					AMPCO18.23		
					AMPCO21		
					AMPCO22		
					AMPCO25		
					AMPCO26		
					AMPCO45		
					AMPCO483		
					AMPCO642		
				AMPCO673			
				AMPCO674			
				AMPCO8			
				AMPCO863			
				AMPCOM4			
		S66286		A286	precip.hardened		
		S35000		AM350		cast	
		S35000		AM350	heattreated		
		S35500		AM355			
		S45500		Custom455			
				Discalloy			
		N08800		Incoloy800			
				Incoloy801			
		N19909		Incoloy909			
				Lapelloy			
				M-308			
		R30155		N-155		bar,forge,ring	
		R30155		N-155			
				Air Resist13			
				FSX-414			
				H531			
				Haynes188		bar,forge,ring	
				Haynes188		tube	
				Haynes25			
				Mar-M-302			
				Mar-M-509			
		R30195		MP159			
				MP35N			
				Stellite21			
				Stellite30			
				Stellite31			
				W152			
				W162			
				Astroloy		allforms	
				GTD222			
		N10665		HastelloyB-2			
		N10002		HastelloyC		plate	
		N10002		HastelloyC		cast	
				HastelloyC-22			
		N10276		HastelloyC-276			
		N06455		HastelloyC-4			
		N06007		HastelloyG			
		N06985		HastelloyG-3			
		N10003		HastelloyN		bar,forge,ring	
		N10003		HastelloyN		cast	
		N06635		HastelloyS		allforms	
		N10004		HastelloyW			
		N06002		HastelloyX		allforms	

WORKPIECE MATERIALS - PALBIT SELECTION MATERIALS, PSM

ISO	DIN	W.-Nr	EN	EN-Nr	AFNOR	BS	UNI
11		2.4816	NiCr15Fe				
		2.4851					
		2.4856	NiCr22Mo9Nb				
		2.4856	NiCr22Mo9Nb				
		2.4856	NiCr22Mo9Nb				
			NiFe38Cr16Nb				
			2.4668	NiCr19Fe19Nb5Mo3			
			2.4668	NiCr19Fe19Nb5Mo3			
			2.4668	NiCr19Fe19Nb5Mo3			
			2.4669				
			2.4669				
			2.4061	Ni99.6			
			2.4634				
			2.4636				
			2.4650				
			2.4631	NiCr20TiAl			
			2.4632				
			2.4662				
			ppm				
				NiCr19Co18Mo4Ti3Al3			
		2.4654	NiCr20Co13Mo4Ti3Al				
		2.4654	NiCr20Co13Mo4Ti3Al				
		3.7024					
		3.7024					
	TiV10Fe2Al3						
		3.7124	TiCu2				
			TiAl5Sn2.5				
			TiAl5Sn2.5				
			TiAl5Sn2.5				
		3.7164	TiAl6V4				
		3.7164	TiAl6V4				
			TiAl6V4				
		3.7164	TiAl6V4				
		3.7164	TiAl6V4				

JIS	SS	UNS	AISI/ASTM	Misc. Brand	Condition	Form	Structure
				IN100			
		N06600		Inconel600		allforms	
		N06601		Inconel601		allforms	
		N06625		Inconel625		bar,forge,ring	
		N06625		Inconel625		tube	
		N06625		Inconel625		cast	
		N09706		Inconel706			
				Inconel708		bar,forge,ring	
		N07713		Inconel713			
				Inconel713LC			
		N07718		Inconel718		bar,forge,ring	
		N07718		Inconel718		tube	
		N07718		Inconel718		cast	
				Inconel901			
		N07750		InconelX-750	sol.treated		
		N07750		InconelX-750	precip.hardened		
				Mar-M-200			
				Mar-M-247		allforms	
				Mod.IN100			
				Mod.IN792			
		N02205		Nickel201			
				Nimonic101			
				Nimonic105			
				Nimonic115			
		N07263		Nimonic263			
		N07080		Nimonic80A			
				Nimonic81			
				Nimonic86			
		N07090		Nimonic90			
		N09901		Nimonic901			
				Nimonic91			
				René95			
		N03260		TDNickel			
		N07500		Udimet500			
				Udimet520			
				Udimet700			
				Udimet720			
		N07001		Waspalloy		bar,forge	
		N07001		Waspalloy		cast	
				Ti(pure)		pure-tube	Ti(?)
			AMS4900,-01,-21	Ti(pure)(grd1-4)		pure-plate,bar,forge	Ti(?)
			AMS4986	Ti10V-2Fe-3Al			Ti(?)
		R58210	ASTMGrade21	Ti15Mo-3Nb-3Al-0.2Si			Ti(?)
		R58650	AMS4995	Ti17			Ti(a+b)
				Ti2Cu			Ti(?)
		R56320	AMS4943	Ti3Al-2.5V	annealed	tube	Ti(?+?)
		R56320	AMS4943	Ti3Al-2.5V		bar,forge	Ti(?+?)
		R54520	AMS4910	Ti5Al-2.5Sn	ELI		Ti(?)
		R54521	AMS4909	Ti5Al-2.5Sn			Ti(?)
		R54520	AMS4910	Ti5Al-2.5Sn	annealed		Ti(?)
		R54620	AMS4919	Ti6-2-4-2	annealed		Ti(?)
		R54621	AMS4919	Ti6-2-4-2	precip.hardened		Ti(?)
		R56260	AMS4981	Ti6-2-4-6	annealed		Ti(?+?)
		R56260	AMS4981	Ti6-2-4-6	precip.hardened		Ti(?+?)
		R56400	AMS4920	Ti6Al-4V	annealed		Ti(?+?)
		R56400	AMS4920,Grd5	Ti6Al-4V	annealed		Ti(?+?)
		R56401	AMS4981	Ti6Al-4V	ELI	ELI	Ti(?+?)
		R56400	AMS4920	Ti6Al-4V		extrusion	Ti(?+?)
		R56400	AMS4920	Ti6Al-4V	precip.hardened		Ti(?+?)

NOTES

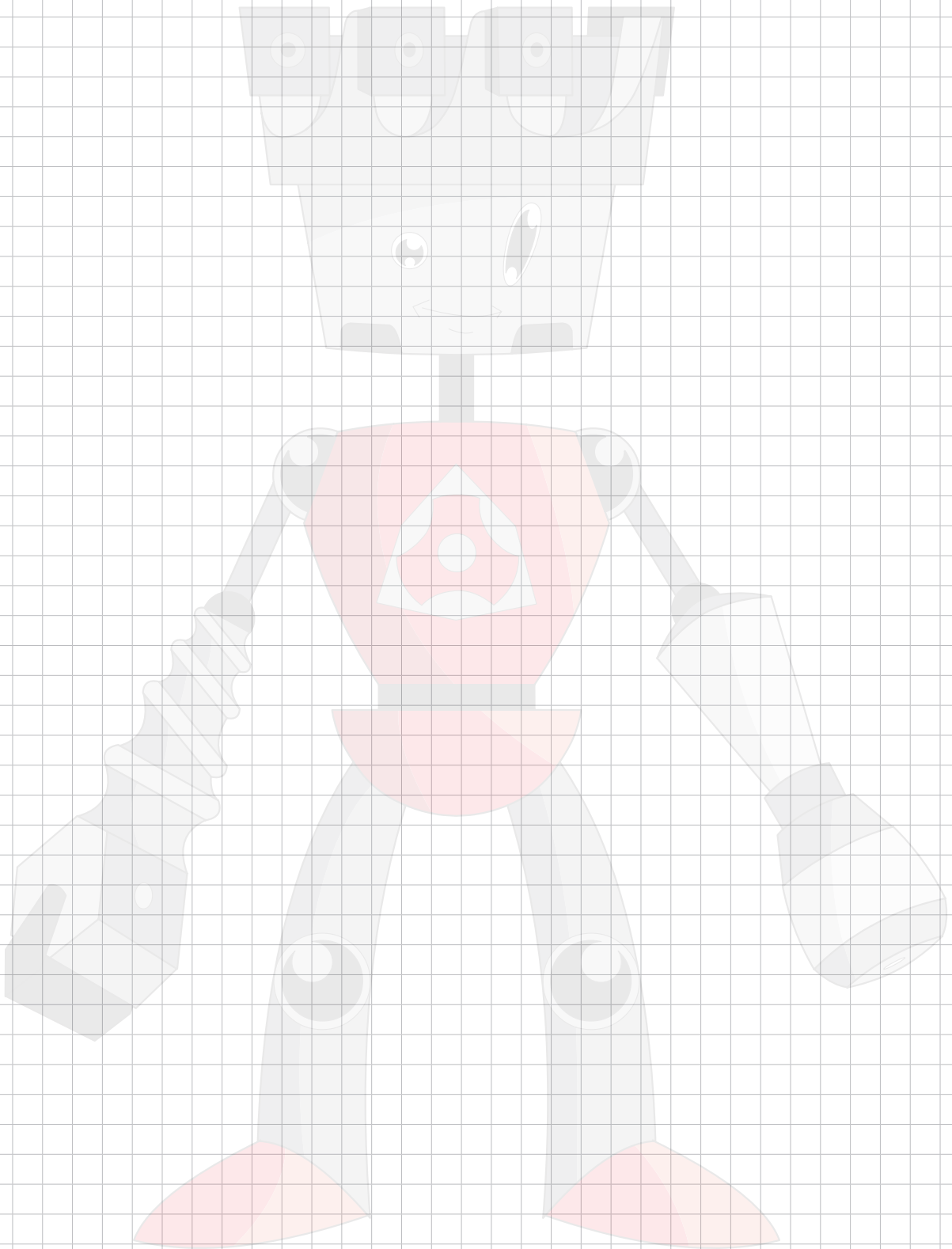

NOTES

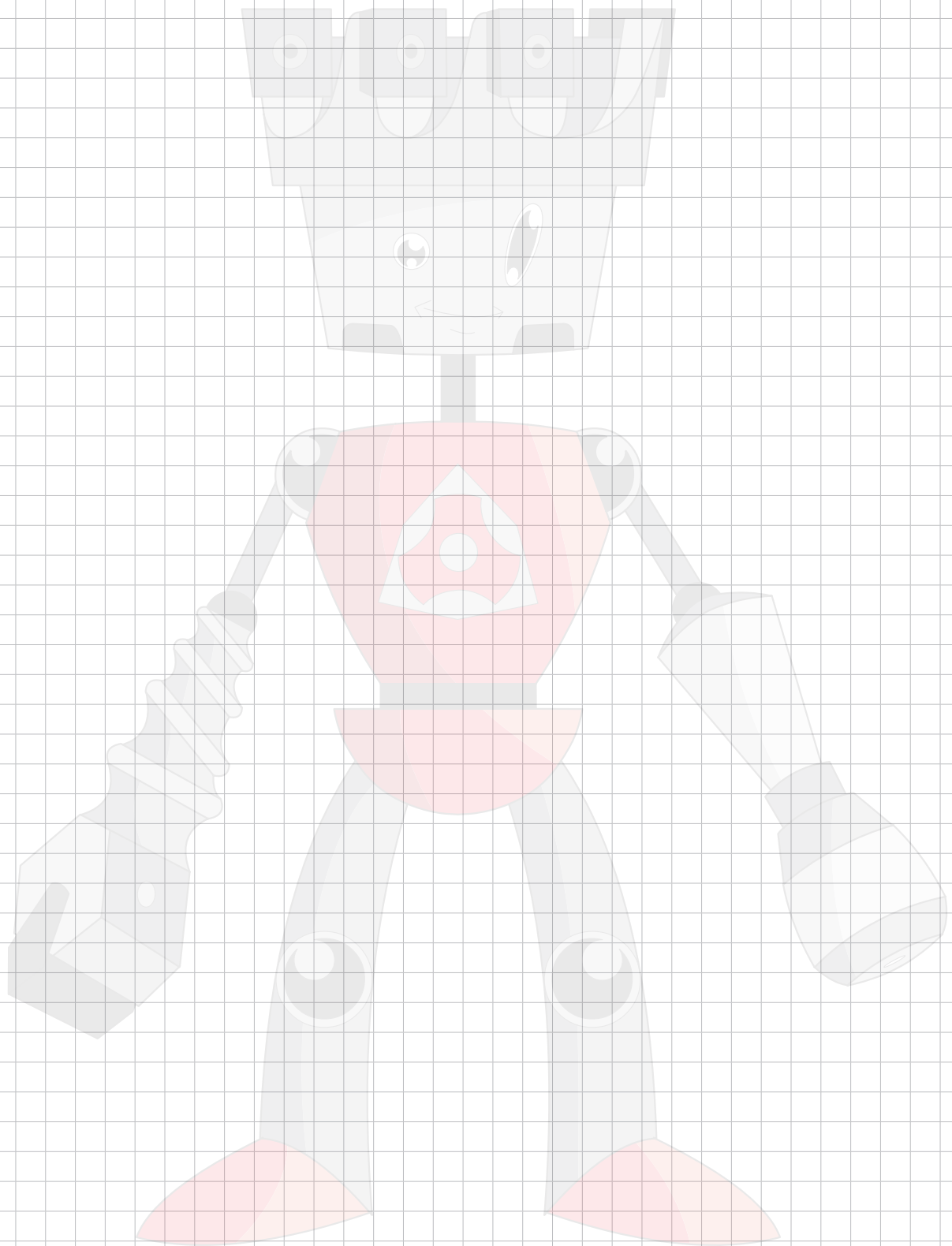



AEROSPACE &
DEFENSE



GENERAL
ENGINEERING



AUTOMOTIVE



MOULD & DIE



RAILWAY



SHIPBUILDING



WIND ENERGY



BAR PEELING



POWER
GENERATION

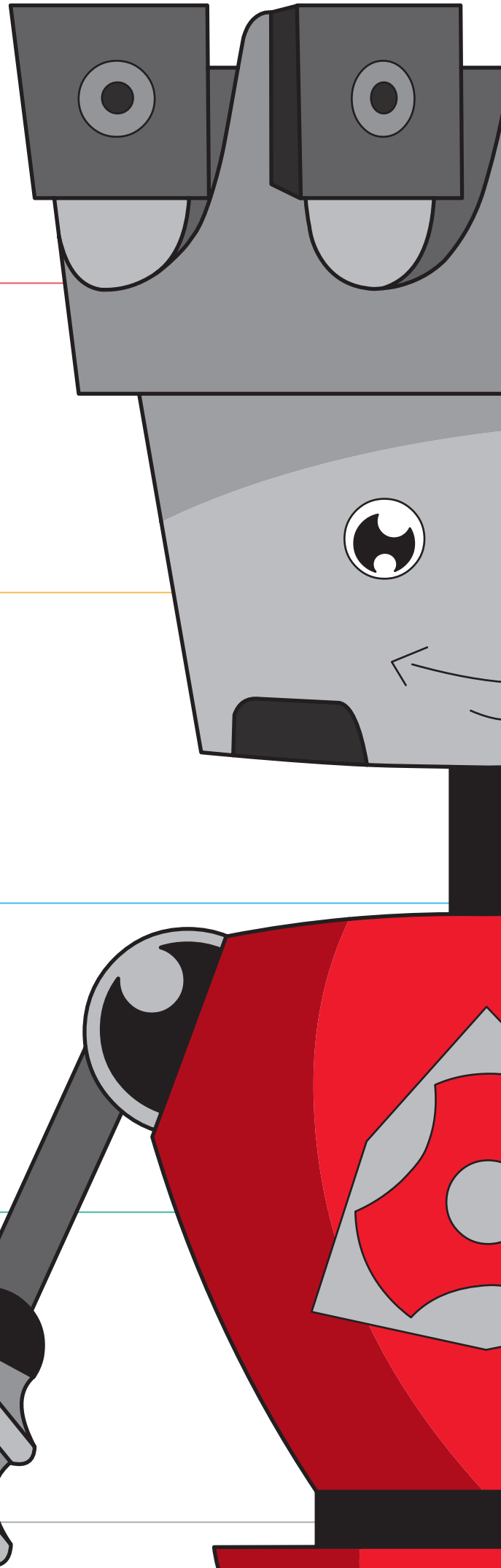

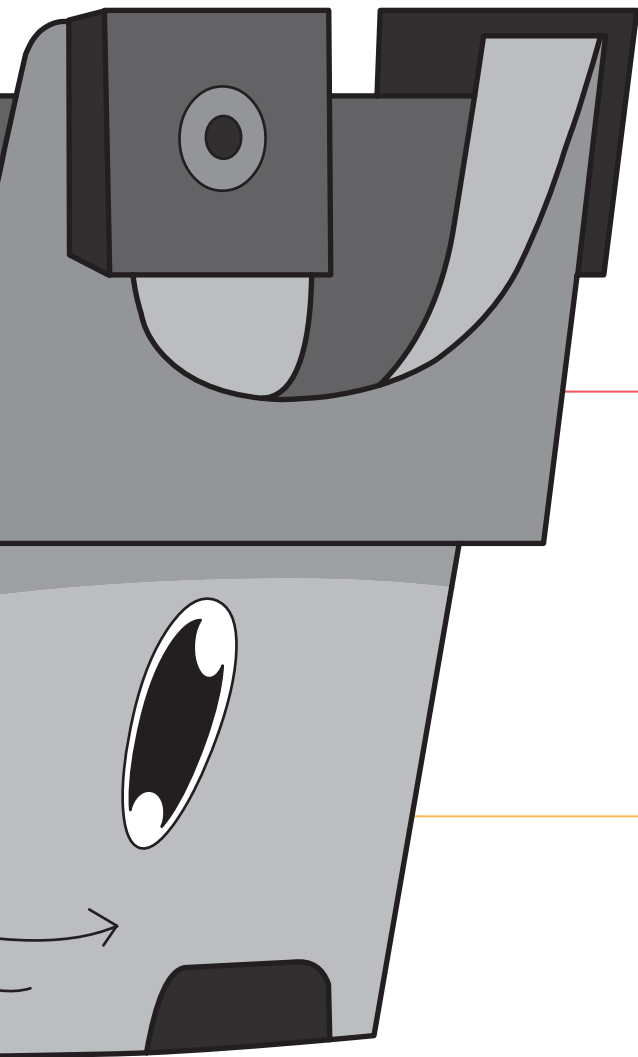

MILLING



DRILLING



TURNING



GROOVING &
PARTING OFF



THREADING

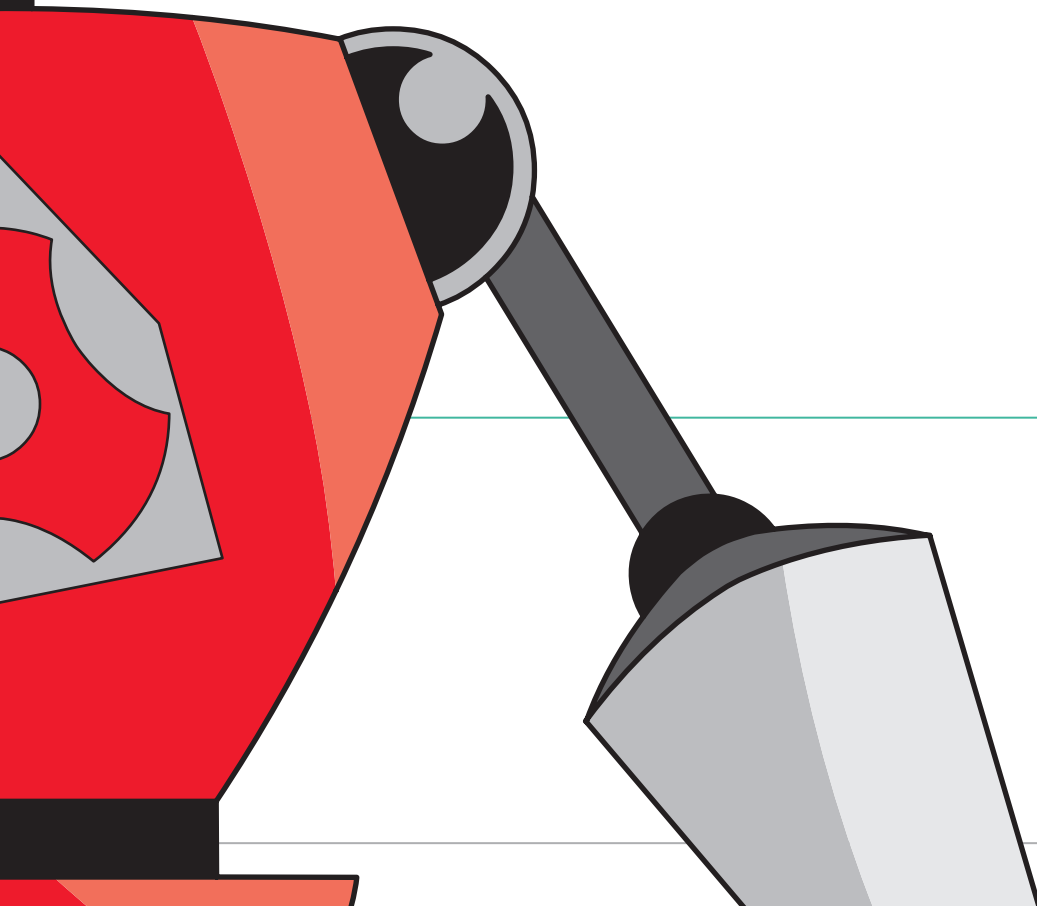

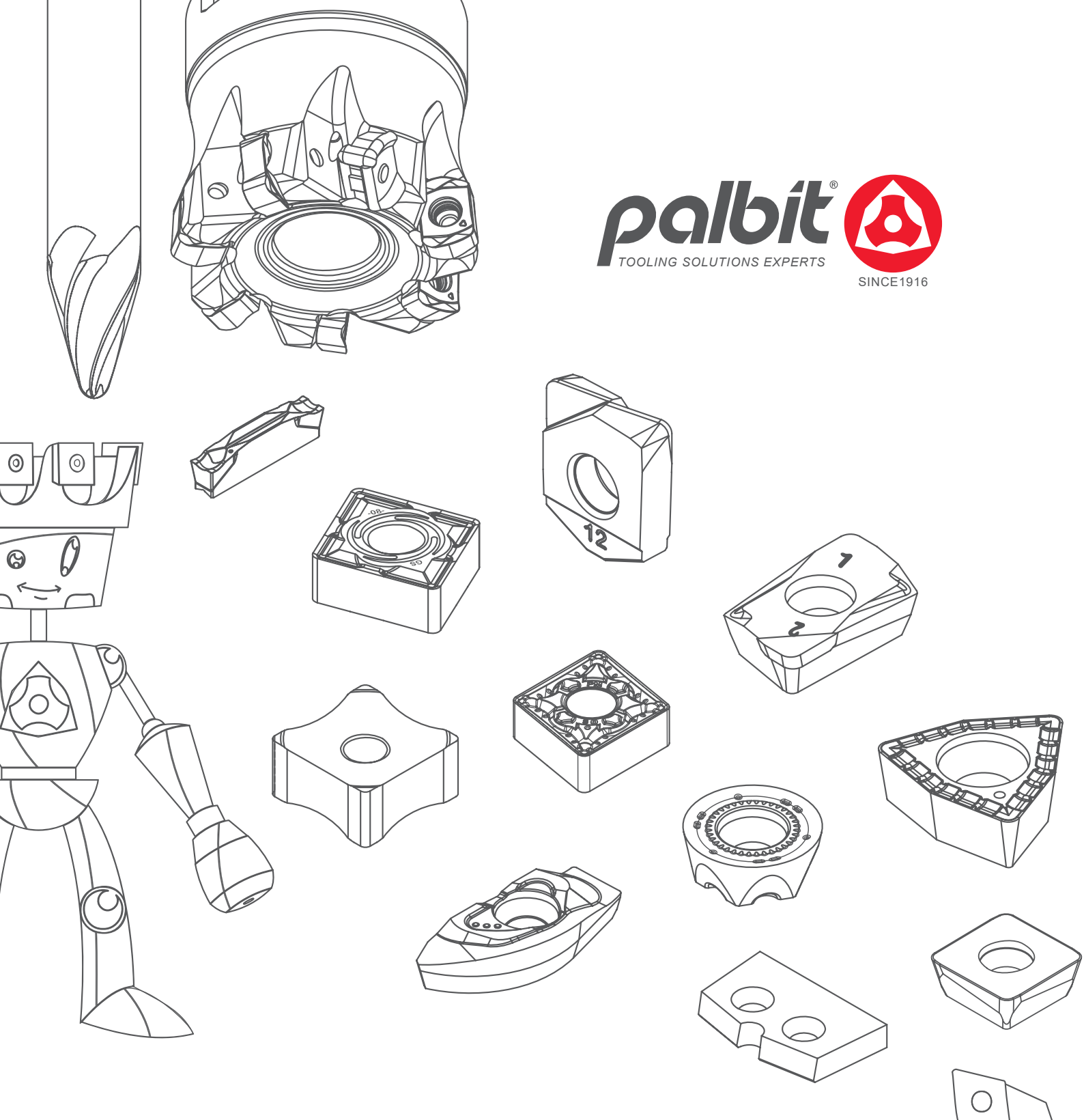

See our e-commerce and find what you are looking for



Check our website and see the latest news

HEADQUARTERS
 PALBIT, S.A.
 P.O.Box 4 - Palhal
 3854-908 - Branca ALB - Portugal
 T. (+351) 234 540 300 | F. (+351) 234 540 301
 palbit@palbit.pt | www.palbit.pt

Branch office:
 PALBIT México
 Emerson 150, Int.803-804, Colonia Chapultepec
 Morales Delagación Miguel Hidalgo
 C.P. 11570 México DF
 T (+52) 5555 454 543 | F (+52) 5552 509 190
 info@palbit.com.mx | www.palbit.com.mx

